

I GENERAL INFORMATION

THE CHOICE OF A LOOM

There are many sizes and types of looms available. Each has advantages for certain purposes, and also disadvantages.

There are many important considerations in choosing a loom.

To what use will it be put?

How much space is available for weaving equipment?

How much can you afford to spend?

A good loom should be deep enough to make a good shed, sufficiently solid for good beating, and well balanced.

TABLE LOOMS

Table looms are mainly rising shed, except for 2-harness looms or rigid heddles looms which are usually counter-balanced looms.

There are three basic operations to weaving: opening the shed, throwing the shuttle, and beating. On a table loom, the shed must be changed by hand and this slows the weaving.

Table looms fill many requirements, and are especially recommended as:

A First Loom: Beginners who do not want to invest too much to start weaving are well advised to consider a table loom. They can always be used later as sample looms, for research and for small projects.

Demonstration Purposes: It is easily transported.

Samples: Less time needed to thread, and many treadling variations are possible without the necessity of changing the tie-up.

Schools: Where space is a factor, and large groups are in the same class, folding table looms are ideal. They are easily stored on shelves.

Occupational Therapy: They can easily be taken into the rooms or areas where they are required.

Rehabilitation Centers: Excellent for finger and wrist exercises, also useful for those who are deprived of the use of their legs.

Weaving Workshops or Guilds: A number of table looms set up in different weaving systems and drafts, and exchanged by the members, speeds the process of learning the craft.

FOOT-POWER FLOOR LOOMS

The largest loom that a single weaver can operate without mechanical assistance is the 150 cm (60") loom. A loom of this size will produce finished cloth of approximately 142 cm (56") and is a wise choice for area rugs, unseamed tablecloths, and bed spreads. Because of its wide weaving width, it offers the greatest amount of possibilities for the weaver. One must remember that very narrow items may also be woven on a very wide loom. The inexperienced weaver or a weaver with short arm reach may find it awkward to throw and catch the shuttle when the loom is threaded to its full weaving width. A flying shuttle beater, which is a mechanical means of throwing the shuttle, may be added to this loom. If you consistently weave over 110 cm (42"), you may wish to consider a flying shuttle beater. Flying shuttle beaters are usually found on looms in commercial production studios.

The most popular size loom is 115 cm (45"). The shuttle is easily thrown and caught when threaded to its full width. It is an excellent size for all items of interior decoration, yardage, wall hangings, rugs, etc. The 90 cm (36") loom can be used for scatter rugs, yardages, linens, drapes, upholstery, etc. It has a satisfactory working width for general purposes. The 70 cm (27") loom is an excellent loom for teaching purposes. It requires little space in a studio. With good designing and careful joining, many large projects can be undertaken with this loom. It is very good for scarves, stoles, small mats, linens, and other narrow items.

REEDS

Because of the variety of yarns used and the different effects desired, an assortment of reeds is necessary. One must remember that to increase the usefulness of each reed, it can be threaded 1, 2, 3, or 4 ends per dent or any number of dents may be skipped.

The most generally useful reed is the 4 dents per cm. (12 dents per inch). This size is provided with each Leclerc loom and can be threaded as follows:

(E.P.CM: ends per centimeter)	(E.P.I.: ends per inch)
1 end every second dent	2 E.P.CM (6 E.P.I.)
1 end every dent	4 E.P.CM (12 E.P.I.)
1 end in a dent and 2 ends in the next dent	6 E.P.CM (18 E.P.I.)
2 ends per dent	8 E.P.CM (24 E.P.I.)
2 ends in a dent and 3 ends in the next dent, etc.	10 E.P.CM (30 E.P.I.)

A steel reed is satisfactory for most weaving. In damp areas, a rust resistant reed is recommended.

The reed on every new loom is treated to prevent corrosion in shipment. The corrosion preventative should be removed from the reed prior to use or it may soil your first weaving. If traces of the corrosion preventative are found in your weaving, it can be removed by dry cleaning or washing depending on the yarn used. To remove the corrosion preventative from a new reed, it should be wiped down with a clean cloth, moistened with white naphtha.

Care must be taken when cleaning between the dents so as to not bend them or damage the paper or tape covering on the reed edge. An alternate method of cleaning the reed would be to make your first warp 25 cm (12") longer than necessary. Weave as usual using a fine weft. The reed will be cleaned prior to the start of your planned weaving.



Fig. 200

A weaver should have a variety of dent sizes of reeds available suitable for his projects. As the texture of the fabric changes so does the size of yarn used and the threads per dent. The most commonly used reeds are: 3 dents per cm for heavy wool, 4 and 5 dents per cm for medium yarns and 6 dents per cm for fine wool. (8, 10, 12 and 15 dents per inch respectively).

At the end of weaving, when the material is removed from the loom, take time to remove any of the fibers that have clung to the reed. If the reed is to be removed from the loom, place it carefully in a dry place where there is no chance of it being damaged. It is best to store reeds standing on end. This helps to prevent damage to the dents caused by things being placed on them. It also provides better air circulation, which will help to prevent corrosion.

Remember that reeds and heddles are important and expensive parts to your loom. It is wise to give them good care.

HEDDLES

Wire heddles are light, slide easily on the frames during weaving. You can put up to 11 heddles per inch on each harness frame without damaging the warp. They are very good for weaving with almost any type of yarn. They tend to catch on each other when bunched during the threading of the warp. Separating the heddles slows the process somewhat. The plating is not as durable as on the flat steel heddles.

Inserted eye heddles: This is a wire heddle with a special eye that has a build up of lead around the circumference on the eye. They slide easily in the harness frames and do not catch together when bunched. They are a good choice because a very wide range of warp thread sizes will glide easily through them because of the special design of the eye.

Large eye heddles: are wire heddles with an inserted eye of 14 mm and 8 mm wide (9/16" X 5/16"). These heddles are used for heavy warp threads. Flat ribbons on warp, rag warp, or leno weave with an extra string heddle which works in the selvage. These heddles have the same advantages as the inserted eye heddles.

Long eye heddles: are wire heddles with an eye of 50 mm long by 3 mm wide (2" X 3/32"). These heddles are used for special weaves such as on the draw loom, pattern harness loom and pick-up or card techniques.

Flat heddles: are easy to thread. They also slide easily on the harness frames when not threaded. You can thread up to 8 heddles per inch on each harness frame without damaging the warp. This style of heddle does not slide easily on the harness frames during weaving. Their heavy weight will be more noticeable on jack looms. For proper spacing, they must always be placed on the harness frame rods in the same precise order in which they are bundled originally.

String heddles

These heddles are seldom used on modern looms. They are time consuming to thread and difficult to obtain. They are useful in a few specific instances such as on a draw loom where a long eye is required or in special pick-up techniques used in conjunction with harness frames on a standard loom. If a weaver wishes to use these heddles, he may make them out of strong twisted linen or mercerized cotton. We suggest to use of a board with headless nails driven in at appropriate distances for the harness frame rods and eye of the heddle. The string should be looped around the first nail and a knot tied at each of the following nails. (Fig. 201)

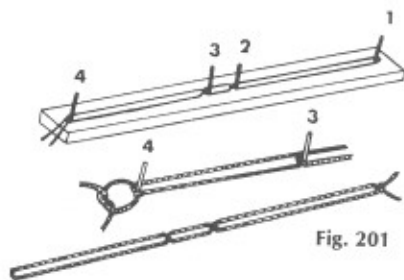

To install the heddles in the harness frames, it is best to remove the harness frames from the loom, if this is possible. The harness frame should be placed on end as shown in Fig. 203. The heddle bars should be disconnected from only one end of the harness frame by loosening the spring clip. (Fig. 202) The cords from the package of heddles should

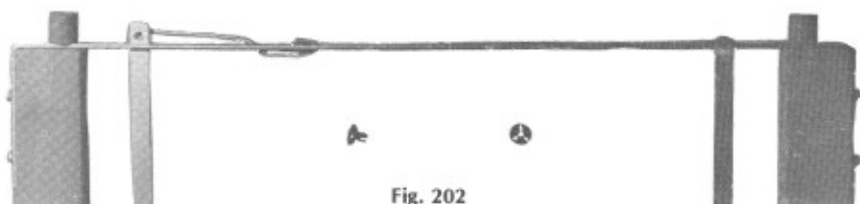

then be tied to heddle bars. (Fig. 203) The heddle bar should be refastened in the harness frame.

To distribute the heddles evenly within the harness frame, simply disconnect the center heddle bar support and arrange the heddles as desired.

If the harness frames can not be removed from the loom, remove only the heddle bars and use the same general procedure to install the heddles on the heddle bars. The heddle bars with heddles installed can then be installed in the harness on the loom.

If the heddle bars of your loom are only punched, disconnect the center of heddle support and take it out of the end frames by bending it.

To remove heddles from the harness frames, reverse the procedure putting them back in a string tied bundles prevent loss, damage, and are always easy to transfer.

SHUTTLES

The purpose of the shuttle is to carry the weft thread from side to side across the loom through the opening or shed.

Both hands are used to work the shuttle — one to insert it through the open shed, the other to pull it out at the other side with the weft thread laid in place.

Shuttles may be obtained in a variety of sizes and designs. The style and size chosen depends on the type of loom used, the kind of weaving being done and the size of yarn needed.

If a long piece of fabric is to be woven, shuttles should be wound with as much thread as possible to prevent a constant joining of new thread.

In winding the yarn or thread on a shuttle, the thread should be held slightly loose to prevent it from stretching and should be wound in even layers.

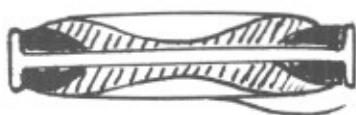

Fig. 204

To wind a bobbin which inserts into a boat shuttle, pile up the ends first and then the center. This prevents threads from catching. The bobbin can be wound with as much thread as permits it to rotate easily within the boat shuttle (fig. 204)



Fig. 205

To wind a wooden quill, with one end finished as a cone and unwinding by the end, used for the flying shuttle, pile up the opposite end, and come gradually to the other end, in order that thread will unroll easily (fig. 205)



Fig. 206

To wind a plain quill unwinding by the end, for a flying shuttle, a cone of yarn should be formed first (fig. 206)



Fig. 207

When using a quill unwinding by turning in the shuttle, build up both sides first, high enough not to have to come back with the yarn at the end, and then fill the centre (fig. 207)

A **boat shuttle** should be smooth, easy to catch, of a form which can be thrown easily without sticking on reed nor on warp.

It should be wide and deep according to the shed opening. On a loom with a small shed, such as a table loom, or for some fine weaving on a floor loom, a shuttle 32 mm. (1 1/4") deep will be recommended.

On an ordinary floor loom, a shuttle 35 mm. (1 3/8") deep is perfect.

On a very large loom, a 45 mm. (1 3/4") shuttle is recommended. It has to be heavy to maintain its momentum when thrown and sufficiently deep to hold weft for large projects.

The flat shuttle is used on a narrow loom, for pick-up patterns and to carry colors when only a few lines are made.

This shuttle should be as long as the width of the fabric. When working with it, you use both hands, for it is not thrown through the shed, but passed by a hand through the shed and taken out by the other hand at the other side. It is for this reason that you need various lengths of shuttles — always corresponding to the width of your fabric.

When using the flat shuttle, you will notice that the yarn will unwind by itself. You may wind as much yarn on this shuttle as it will permit it to pass through the shed easily. If the shuttle is wound too full, it will cause an unnatural separation of the shed, which may break the warp.

On small looms that have no beater, the edge of the flat shuttle is used to beat.

A **rag shuttle** is used for a rag weft. To be thrown easily, it should not be filled beyond its edge. The rag shuttle with curved edges and the ski shuttle can be filled to capacity.

The ski and the rag shuttles are used for heavy rug yarn, heavy wool, etc. Rag shuttles with a rod in them can be used with up to three bobbins, which enables you to throw more weft thread with each shot.

When using two threads on the same shot in the same shed, use a shuttle carrying two bobbins.

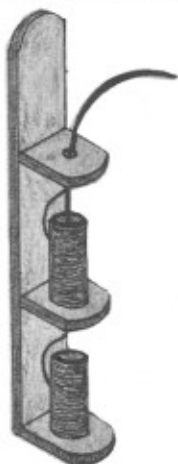

Fig. 208

When using two or more threads on a single bobbin, twist the threads first to prevent them from catching in the shuttle, and do not apply a heavy tension when winding the bobbin.

To twist two or more threads, use this system. It works by passing the thread through the center of the top cone and by pulling both the threads together. (Fig. 208)

The smaller the cone, the more twists per meter.

When using this system with more than two cones, always place the additional cones below the first two cones.

II TIE-UP

Leclerc looms have an easy, trouble free system to accomplish the tie-up. All tie-up cords are of the same length. The system improves the opening of the shed by automatically increasing the travel of the harness frames in relation to their distance from the beater. The rear harness frames have more travel than the front harness frames.

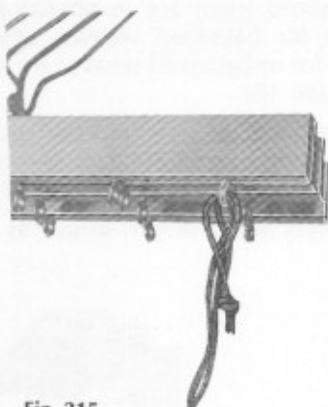

Fig. 215

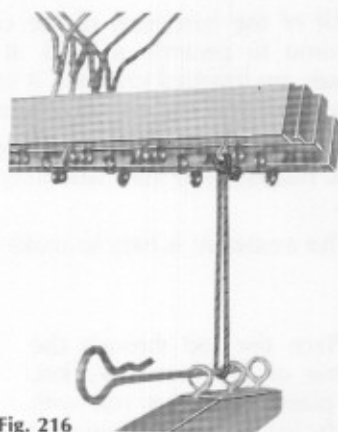

Fig. 216

The tie-up cord is pulled through the screw eye in the lamm. The knot in the end of the tie-up cord will retain it in the lamm screw eye. A metal treadle tie-up hook is used to connect the tie-up cord to the treadles. It is held in place on the treadle by spring tension on one of the treadle screw eyes.

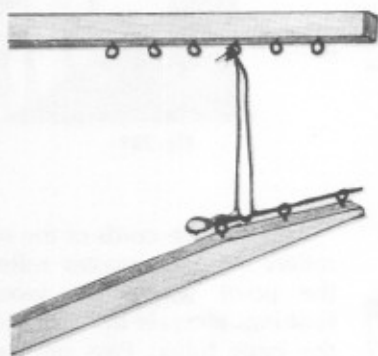

Fig. 217

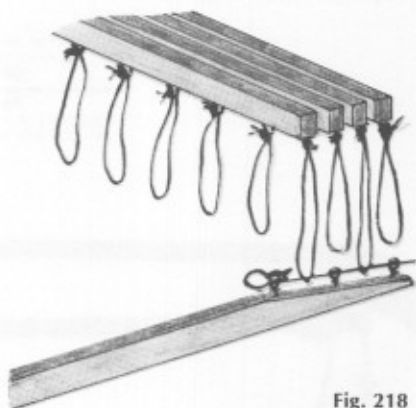

Fig. 218

On Leclerc floor looms, the tie-up cords may be left in place on the lamms when not being used. Tie-ups can be changed in seconds without difficulty.

III COUNTER-BALANCED LOOM

(Sinking Shed Looms)

This style of loom is exceptionally smooth to operate. It provides fast effortless treading and is noiseless. It is excellent with all fibers and is superior with non elastic fibers, such as linen, nylon, etc.

All of the harnesses of the counter-balanced loom are in operation at the same time to provide a shed. It is perfect for balanced weaves where two harnesses are lowered together. It can be used for unbalanced weaves by adjusting the top roller or using a shed regulator. (See page 18)

Leclerc counter-balanced looms are equipped with nylon bearings on the harness rollers. They turn smoothly, are easy to operate, and never require lubrication.

The assembly is easy to make and the height adjustment is simple to alter.

Place the rod through the top hole of the metal bracket. Then, place one wing nut with wings facing up on the threaded rod and lower the assembly down and through the bottom hole of the metal bracket. Place another wing nut, with wings facing down, on the rod. Harnesses are adjusted by moving rod up or down. (Fig. 221)

HAVE THE TOP OF THE HARNESS
AT THIS LEVEL.



AJUSTEZ A CE NIVEAU
LA HAUTEUR DES LAMES.

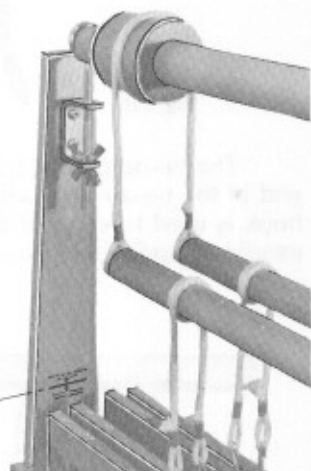

Fig. 221

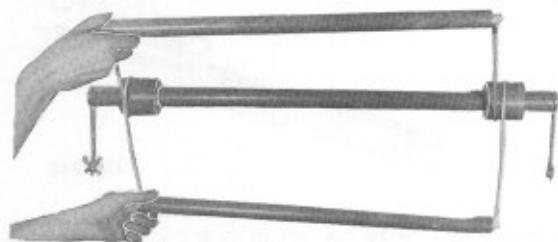

Fig. 222

Place the cords of the small rollers over the master roller at the point where the wooden bushings increase the diameter of the large roller. Pass one small roller inside the cord and over the bushings again to make 1 1/2 turn. (Fig. 222)

To connect the cords, which suspend the harness frames from the small rollers, make 1 1/2 turn around the small rollers. It is important that the cords be coiled on one side to the right and on the other to the left. When the rollers turn, this will cause cords to work to the right or left and return to the original position. This action keeps the harness frames balanced. (Fig. 221). Harnesses are suspended from these cords.

The height of the harnesses should be adjusted in a manner that when the four harnesses are at the same level in the neutral position, the center of the heddle eye will be 5 mm. (3/16") higher than the top of the thread and breast beams. A string tied from the thread beam to the breast beam will be helpful in making this adjustment. Harnesses adjusted in this manner will provide slightly more tension on the lower shed resulting in a better support for the shuttle. During weaving, care should be exercised that the warp is never allowed to come in contact with the sharp twisted wires at the ends of the heddles, as damage to the warp can result.

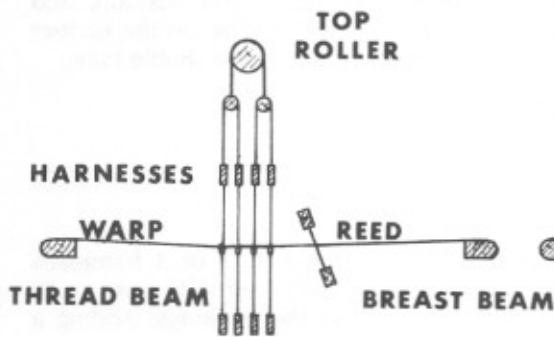

Fig. 223

When harnesses on counter-balanced loom are at their neutral position, the warp should run through the bottom of the eye of the heddle, and 5 cm. (2") above the bottom edge of the reed.

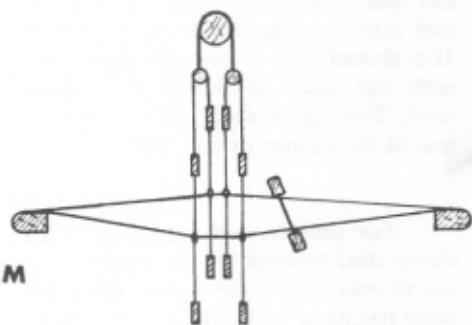

Fig. 224

When using 2 harnesses against 2 in a balanced weave, the shed should go to the bottom of the reed and be at least 8 cm. (3") high.

Each Leclerc loom has factory markings (see Fig. 221) showing the correct height of the harnesses for balanced work (that is, 2 harnesses going down against 2 harnesses up). Adjust the wing nuts so that the harnesses are at the correct height.

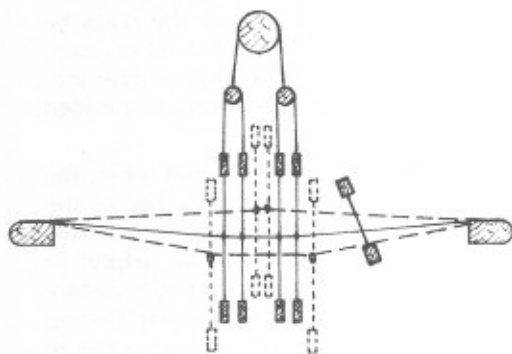

Fig. 225

Harnesses too low: The solid line shows the thread when harnesses are too low. The warp makes a pronounced curve going down in the center. The dotted line shows an open shed with the warp at the bottom of the reed. The upper shed will be more or less at the center of the reed.

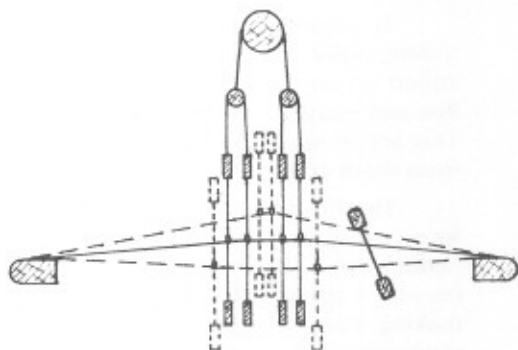

Fig. 226

Harnesses too high: The warp curves upwards at the neutral position, and the threads will not lie on the bottom of the reed, nor on the shuttle race.

For unbalanced weaving, where you need sometimes 1, 2 or 3 harnesses down and sometimes harnesses up, you should use a wide reed (127 mm. — 5" wide) and adjust the harnesses 1 cm. (3/8") higher than the markings. Adding a shed regulator will give a better result.

If your material requires only 3 harnesses down with 1 harness up, as well as balanced sheds, lower your master roller 1 cm (3/8") and you will get a good shed.

If your loom is not a model with the master roller adjustable with a screw, shorten or lengthen the top roller cords to accomplish adjustment.

IV SHED REGULATOR

Your new Leclerc conterbalanced loom “Nilus II” is equipped with a shed regulator.

Here is the way it works:

When you make a balance weave, it is to say two harnesses against two which can be either 1-3, 2-4 or 1-2, 2-3, 3-4, 4-1 or any other combination of two harnesses against two, you can stop the shed regulator by introducing a pin in the hole on the head of the loom and in the corresponding hole in the large pulley in order to maintain warping line from back to front of the loom. (See fig. 235).

For unbalance weave of one harness down against three up or three harnesses down against one up, take off the pin which stop the pulley on the head of the loom. Set the tension of spring in order that it holds the harnesses at proper height to keep warp lightly heigher than straight line from back to front of the loom when at rest. This adjustment of spring is made by changing the hook on spring to different link of the cord. Your shed regulator is now ready to operate.

If the shed is not good readjust by giving more or less tension to the spring by placing the hook of the spring in a different link of the cord.

Shed regulator allow lower or heigher harnesses to run same distance. This is specially important with a non elastic fiber warp such as linen.

It also save the advantages of the conterbalanced loom, it is to say a easier, treadeling, smoother, quicker and noiseless. This system needs a little of patience to understand it, taking used of it and have the maximum of its used.

COMPOUND TIE-UP

When there is a need for a greater combination of tie-ups than treadles available (i.e. the loom has 6 treadles but you need 8), we use the compound tie-up. This is possible by using two treadles at the same time.

For this treadling, put more tension on the spring of the shed regulator. You must engage the shed regulator by removing the metal pin from the pulley. Let the shed regulator lift the whole harness, and use it as a lowering shed loom. This will work very easily and give a good shed.

The **shed regulator** is a device which permits the whole set of harnesses to:

- raise when one harness lowers and three harnesses raise;
- lower when three harnesses lower and one harness raises;
- stay at the center when two harnesses lower and two harnesses raise.

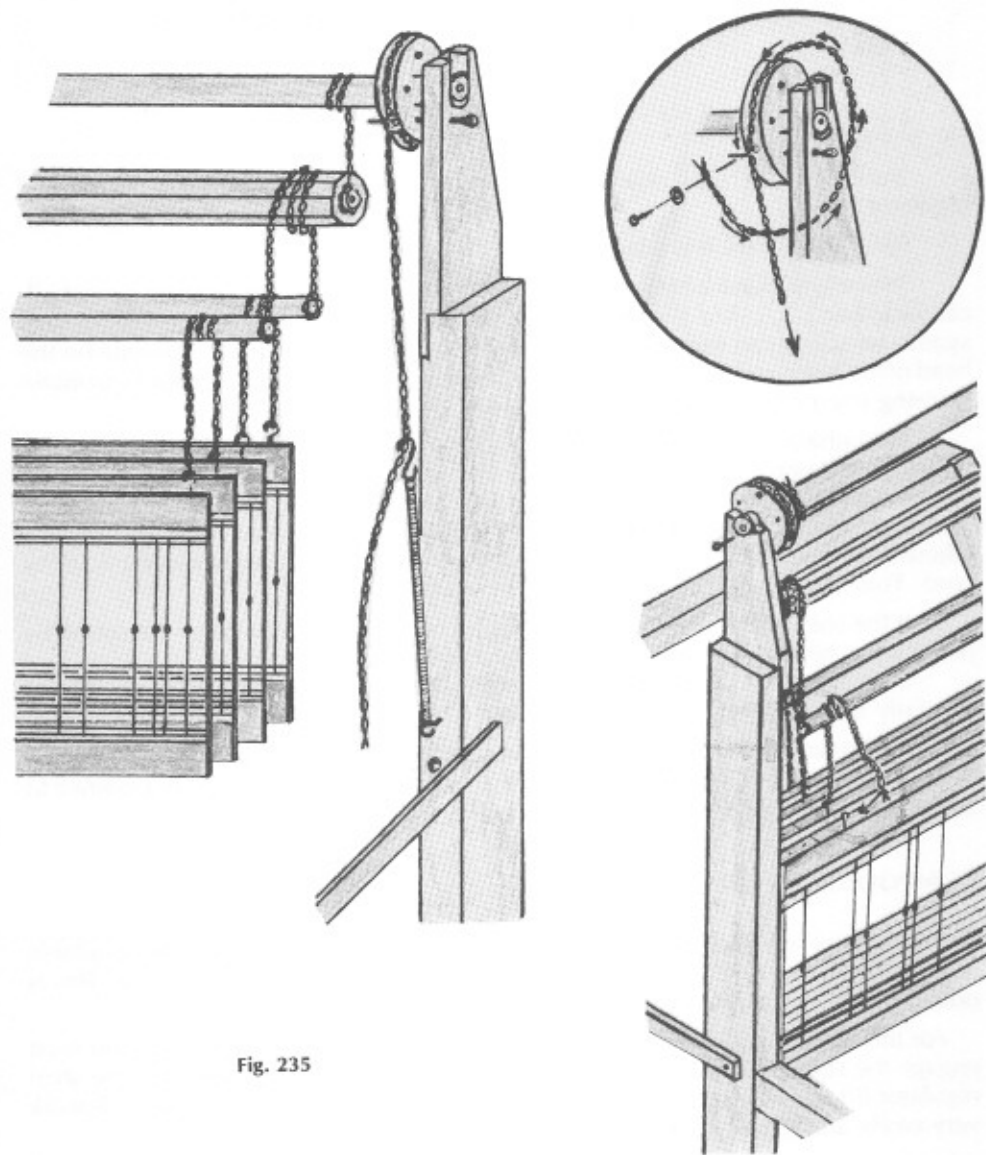

Fig. 235

The illustrated shed regulator has been designed to be very simple to operate. It is easy to understand. The action of the shed regulator can be set for balanced weaves, i.e. two harnesses against two.

The shed regulator is used only on counter-balanced looms such as Mira, Fanny, Nilus II and Artisat equipped with a kit to convert into a counter-balanced loom.

Instructions are supplied with the shed regulator.

Normal height of roller

Two harnesses lowered,
two harnesses raised.

Three harnesses lowered,
one harness raised, the
complete harness system
lowered.

Three harnesses raised,
one harness lowered, the
complete harness system
raised.

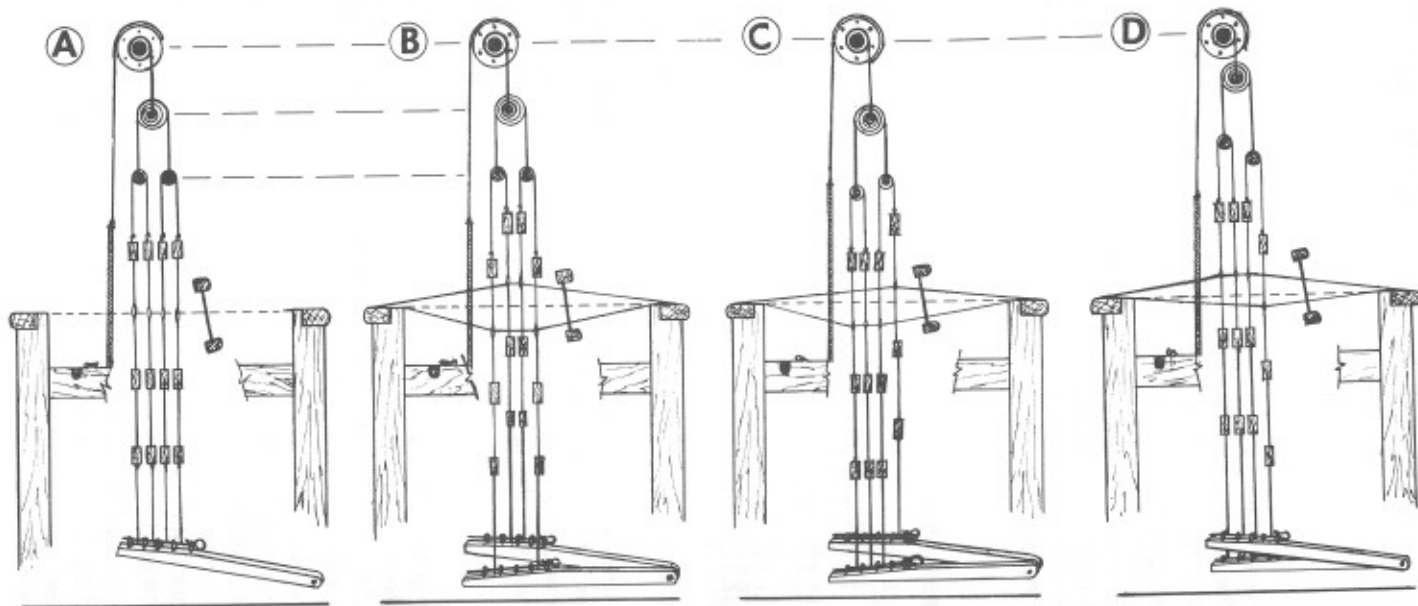

When Shed Regulator is not used, stop action of spring by introducing the pin in the hole of the pulley.

Help the harnesses to stay at normal height by adjusting the "S" hook of the spring in the proper loop of the cord connected to the pulley of the shed regulator.

Fig. 236

V JACK-TYPE LOOM

(Rising Shed Looms)

Each harness operates independently on this loom. It gives a perfect shed, regardless of the tie-up. It is very good with elastic fibers such as wool, cotton, rayon, etc. There might be slight difficulty with linens and other non elastic fibers.

The treadling action is slightly heavier than on counter-balanced looms.

This is the most popular type loom sold in North America. It requires very little care. It is quickly and easily set up. Any combination of one, two, or three harness frames may be tied to any individual treadle, resulting in a loom of excellent weaving potential.

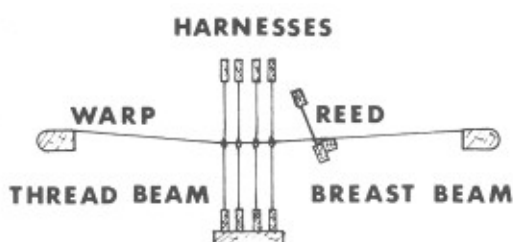

Fig. 245

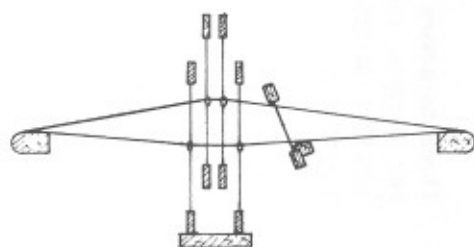

Fig. 246

When all the harnesses are down on a rising-shed loom, the warp makes a curve going down, and rests on the bottom of the reed and shuttle race.

When the shed is open, the curve of the warp that is raised should be slightly greater than the curve of the warp that is at rest.

Do not keep the warp at too great a tension on this type of loom, or it will raise the harnesses and put weight on the warp. If the warp does not rest on the shuttle race, it is because the warp is too tight. Remember to take special care with non-elastic yarns.

The shed is made by the upward travel of harnesses. The tension on the upper shed is much greater than that on the lower shed. The lower shed may actually become slightly loose. This looseness is usually not as noticeable on a wool warp as it would be on a non elastic warp, such as linen. Here your shuttle race that has been installed on the jack loom, will help you. It prevents the shuttle from slipping through the shed.

A word of caution, if in weaving a rug or similar heavy article, you try to correct the shed by putting excessive tension on the warp. The treadles will be difficult to operate and the shed will be reduced. This will be especially noticeable on non elastic warps.

To weave non-elastic fibers such as linen, silk, nylon and many other man-made fibers, the shed may be difficult to open because of excessive tension being placed on the warp. Reduce the tension to the minimum required for a good weaving.

If a very high tension is required on a warp you may find that the harness frames do not settle back to their full down position. To eliminate this, attempt to lower the slabstock further to cause the warp to draw down on the harness frames. When weaving on a folding loom, it should always be opened to maximum extent normally possible. The greater the distance between the slabstock and breast beam, the better the shed will be.

The following procedures may be used to keep the harness frames in full down position while weaving:

- a) Add weight to the harness frames.
- b) A rubber band, piece of elastic or light spring may be connected to the bottom of the harness frame and to the loom.
- c) Use a double tie-up, i.e. tie a cord direct from the harness frame that you wish to remain full down to the treadle that is in the full down position. (When this treadle is then depressed, it will raise the frames you have normally tied up and also drive the additional tied harness frames down).

Use of any of the above procedures will cause the treadling action to be heavier and slower.

When open, the lower shed must rest on the shuttle race. On most of the looms, the beater can be adjusted in height by loosening the nuts on the lower end of the batten. The beater should be adjusted to the proper height and the nuts firmly tightened. So, they will not loosen when subject to the vibration of weaving.

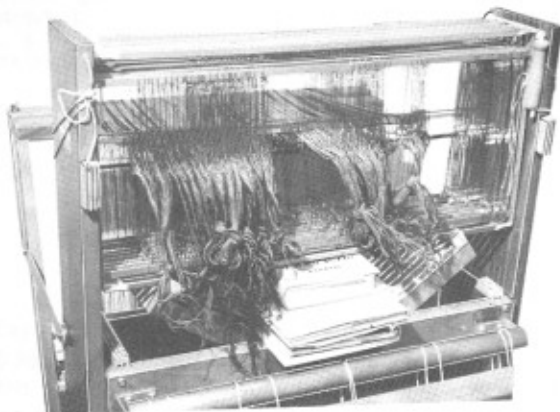

Fig. 247

To remove harnesses from loom, gain access to them by removing the top cover board if your loom has one installed. The top cover board can be removed by shifting to the front or rear depending on the style of loom and lifted off. The harness frames can then be picked up for removal.

For easy threading, raise the four harnesses and use anything suitable such as a book, board, box, etc. to keep them raised.

VI REED SELECTION

The choice of the reed, which should be used for a selected material, depends on the thickness of the yarn and the weave structure. It can be a material where the warp is as important as the weft, example: tabby weave or twill where the sett is the same for the warp and the weft. This exists on any basic weave.

- It will vary: — if you desire a warp effect — where the weft should not appear — then it needs more ends per cm. or
- if the weft should cover the warp entirely as on tapestry weave. The number of ends has to be low to allow to cover the warp completely.

Only experience and trial can give the exact reed that should be used. The following information may be helpful in selecting the proper reed and starting a sample.

Using a ruler, wind the warp around it. The windings should be as close as possible, but not overlapped. Count the number of threads covering one or more cm. (We suggest to cover at least 4 cm. on the ruler.) This gives you the number of threads that should be considered as a maximum.

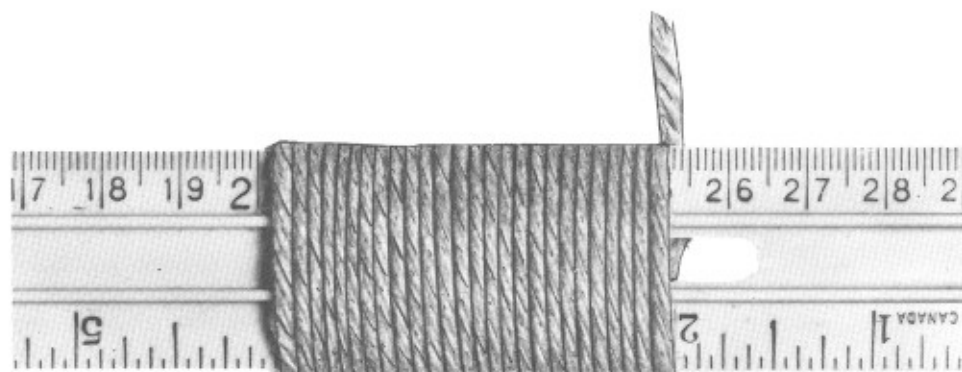

Fig. 255

Example: A two-ply fine wool will give 54 turns per 4 cm. or 14 turns per cm. If the material is to be a light twill or tabby weave, divide the number of turns by two, which will give 7 turns, or ends, per cm. and use reed number 7 with one end per dent or use a reed of 4 dents per cm. with two ends per dent (8 dents per cm.) This will give a little heavier material.

With a basket weave, the reed should be a little finer, as the weft will cross only at every two or three, or even four threads of warp. A reed of 5 dents per cm. with two ends per dent will be right.

If the weft should cover the warp completely, as in tapestry, we suggest that the number of ends per cm. be only 25% of the number on the ruler. Our example: From the 14 ends, 25% equals 3.5 ends per cm., so you use a 3.5 dent reed, or use a 7 dent reed and skip every second dent.

If it is a warp effect, then try 75% of the number found on the ruler. Then a reed of 5 dents with two ends per dent will be suitable.

	Tex Count	Number of turns per centimeter	Basic weaves Tabby or twill	Open warp Weft covering warp Tapestry	Warp covering weft	Number of turns per inch	Basic weaves Tabby or twill	Open warp Weft covering warp Tapestry	Warp covering weft
			50%	25%	75%		50%	25%	75%
Two-ply wool No. 16/2	2/55	17	8 or 9	4	12	41	20	10	30
Two-ply fine wool		14	7	4	10	36	18	9	27
Linen No. 40/2	2/42	25	12	6	18	68	34	17	50
16/2 cotton	2/37	22	11	6	17	54	27	14	40
8/2 cotton	2/74	17	8.5	4	12	45	22	11	32
Mop yarn		3.4	2	1	2.5	8.5	4	2	6

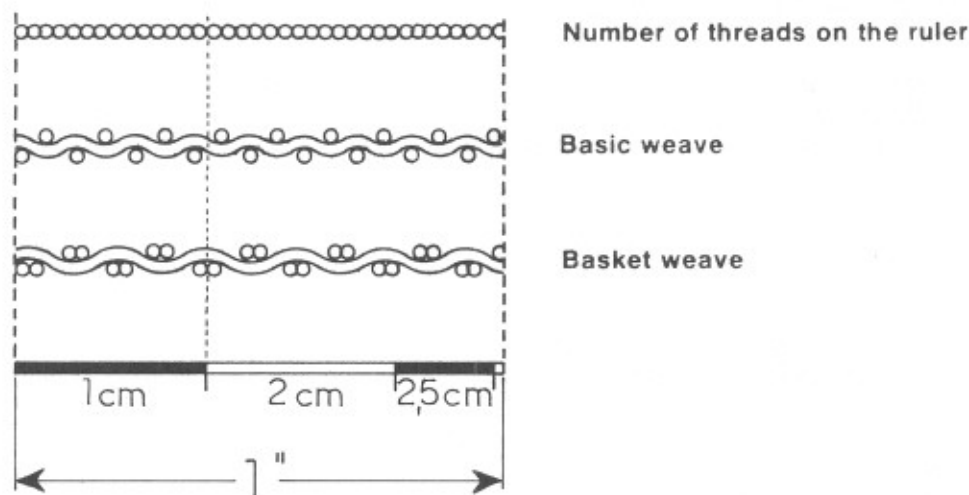

Fig. 256

Reeds available in 2, 3, 4, 5, 6, 7, 8 dents per cm.
5, 8, 10, 12, 15, 18, 20 dents per inch

VII WARPING METHODS

There are many different kinds of warping systems. We propose to describe several, and discuss the relative merits of each.

We have placed the sectional warp beam first, and would like to emphasize that the different types of warping (sectional and chained) are not interchangeable.

The method of estimating yarn requirements is the same for all methods.

TO ESTIMATE YARN REQUIREMENTS

In the calculation of yarn requirements, we start with three established facts:

1. The finished length of cloth we want.
2. The width of the warp in the reed. (Width of material wanted plus shrinkage.) The stretching of the material will vary according to the texture of your material, the pattern, the kind of yarn used, and also your weaving ability. In general, this is from 7% to 10%.
3. The sett of the warp. (How many ends per cm. or inch of yarn we need.)

For weavers using the METRIC system:

Let us suppose we want a finished length of cloth of 10 meters, 56 cm. in the reed, sett of 10 ends per centimeter.

56 cm. in reed	10 meters finished length of cloth
× 10 ends per cm.	+ 50 cm. take-up of warp (5% to 7%)
<hr/>	+ 70 cm. loom waste at both ends of the warp
560 total of ends needed	<hr/>
	11.20 meters minimum length of warp

Your warping system will determine how close you can come to the desired yardage. We will assume that we have to warp either 11 1/2 or 12 meters, depending on the system.

The weaving yarns we use give us the yardage per kilogram of yarn. The table at the back of this booklet gives us the count of the most commonly used threads.

We assume that we are using 2/74 cotton which has 6757 meters per kilogram.

560 ends of yarn
× 11.5 meters (length of warp)
<hr/>
6440 meters of yarn required for warp, which will be a little less than 1 kilogram of cotton at 6757 meters per kg.

For weavers using YARDS and POUNDS:

Our plan is for a finished length of cloth of 10 yards, 22 inches in the reed, sett of 24 ends per inch.

22 inches in reed	10 yds. finished length of cloth
$\times 24$ ends per inch	+ 1/2 yd. take-up of warp (5% to 7%)
<hr/> 528 total ends needed	+ 2/3 yd. loom waste at both ends of the warp
	<hr/> 11 1/6 yds. minimum length of warp.

Your warping system will determine how close you can come to the desired yardage. We will assume that we have to warp either 11 1/2 or 12 yards, depending on the system.

The weaving yarns we use give us the yardage per pound of yarn. There is a table at the back of this booklet which gives the count of the most commonly used threads. We make the assumption that we are using 8/2 cotton which has 3360 yards per pound.

528 ends of yarn
$\times 11\ 1/2$ yards (length of warp)
<hr/> 6072 yards of yarn required for warp, which will be a little less than 2 pounds of cotton at 3360 yards per pound.

Add 4 strong threads at each side:

- A) If a heavy selvage is wanted in order to keep the width of the material.
- B) To prevent the fine warp thread of the selvage from breaking.
- C) When the pattern will not allow the regular selvage thread to be woven by the weft.

These four extra strong threads should be threaded in a way that they will always be kept by the weft, usually one thread per harness.

The weft requirements are generally considered to be the same or fractionally less than the warp requirements.

A — SECTIONAL WARP BEAM

A sectional warp beam consists of 4 sectionally divided strips that are attached to your warp beam. Each strip is divided into 25 mm or 50 mm (1" or 2") sections by metal "U" shaped cramps, which hold the warp threads in their proper section. When the sectional strips are attached directly to the warp beam, they hold 1/2 meter (1/2 yard) per turn. Wooden extensions can be installed between the sectional strips and the warp beam. This will allow for one meter (one yard) of warp per turn. (Fig. 260)

8 sectional strips
with extension:
99 cm.

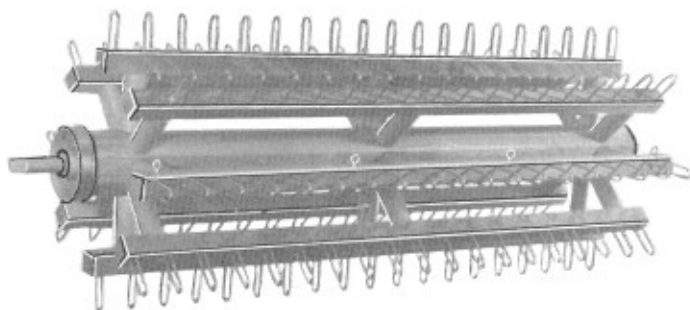

Fig. 260

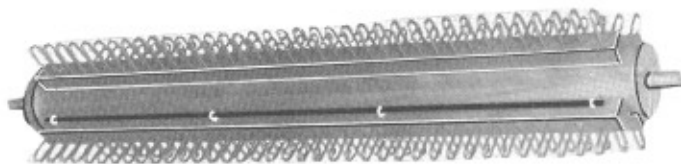

Fig. 261

4 sectional strips
direct on the beam:
47 cm.

It is very important that you fill each section with threads evenly spaced across the entire individual section. Never bunch the threads in a portion of the section or the circumference will not grow evenly and the tension of the warp will not be uniform.

Leclerc floor looms have pre-drilled holes on 4 faces of the warp beam to attach the sectional strips with wood screws. It is for this reason the canvas apron is not attached at the factory on new floor looms.

When sectional strips are attached to the warp beam, they hold 1/2 meter (yd.) of warp per turn. Wooden dowel extensions, as per Fig. 260, are available for installation. The beam will then hold 1 meter (yd.) per turn. It is recommended for weavers who regularly make long warps (40 meters (yds.) or more) that they install 2 sets of sectional strips on the warp beam. The warp beam will then have 8 of the sectional strips installed instead of the normal 4 strips.

We also suggest that for warps of more than 40 meters (yds.) the wooden extensions be used and the 8 sectional strips to provide 1 meter (yd.) per turn. Be advised that when the wooden extensions and sectional strips are installed, the rear of the loom cannot be folded.

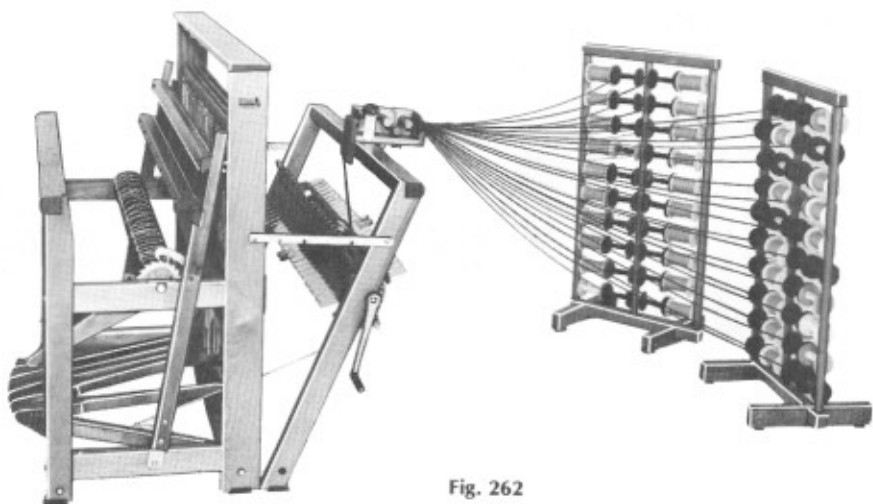

Fig. 262

This system of warping takes threads from bobbins, passes them through a tension box to maintain even tension for winding on the warp beam in the individual sections.

It requires the use of as many bobbins loaded with thread per individual section as your planned sett in the reed. If your warp is to be set at 24 ends per 25 mm (1 in.), you will need 24 bobbins for a sectional beam with 25 mm (1 in.) sections or 48 bobbins for a beam with 50 mm. (2 in.) sections.

All bobbins should be of the same type, size, and weight to assure even tension. You may use commercial bobbins or tubes, plastic or wooden bobbins providing they have the same type of ends. Bobbins without end pieces, tubes and cones, should be drawn while standing on end with the use of a cone holder (Refer to the Leclerc catalogue). This provides a more even tension. You can also use reels instead of bobbins to distribute the ends number needed to the warping. The reel must be stood on the floor and can be used with cones, tubes and other endless bobbins. (Refer to the Leclerc catalogue.)

The amount of yarn required on each bobbin is calculated by multiplying the length of the yarn in each section by the number of sections required. On an 11 1/2 meters (yd.) warp, 56 cm. (22 inches) wide in the reed, sett at 24 ends per section and using a beam with 25 mm. (1 inch) sections, the requirements would be 24 bobbins each holding 11 1/2 meters (yds.) \times 22 sections = 253 meters (yds.). The same warp on a beam with 50 mm (2 inches) sections would require 48 bobbins each holding 11 1/2 meters (yds.) \times 11 sections = 126 1/2 meters (yds.) of yarn.

For calculation of the warp, see page 37.

The warp should be centered on the loom. If we put our 56 cm. (22") warp on a 115 cm. (45") loom with a beam divided into 50 mm. (2") sections, we would have to leave 6 empty sections at each end. The 70 cm. (27") and the 115 cm. (45") sectional beams that are divided into 50 mm. (2") sections, have 2 sections of 25 mm. (1") at each end.

THE TENSION BOX

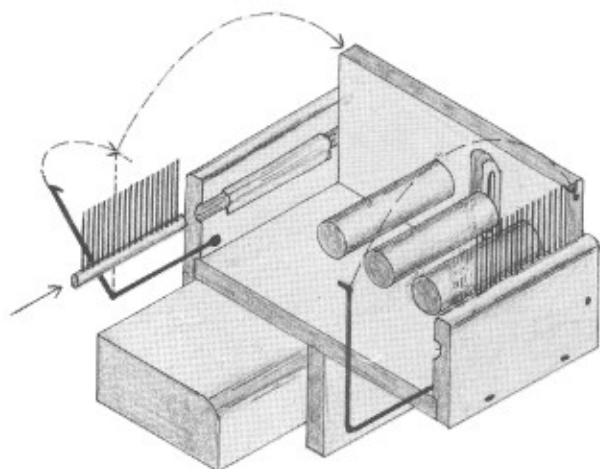

Fig. 263

It is not necessary to have a comb of the same dentage as the reed, as long as the threads are spread evenly and equally to the same size as your section. If you prefer the same dentage, the combs can be changed easily, by sliding them out of their grooves. (Fig. 263)

Attach the tension box to the rear beam of the loom. Remove the center dowel which is in a slot. (Figs. 263 and 264)

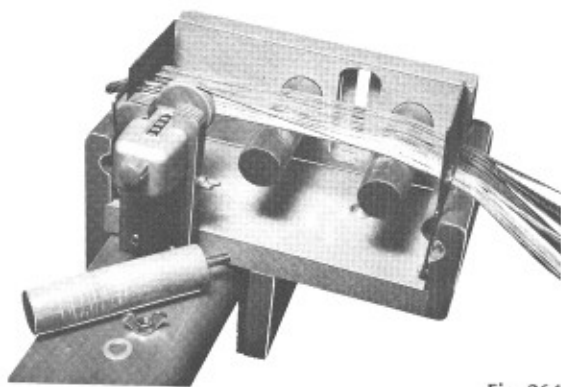
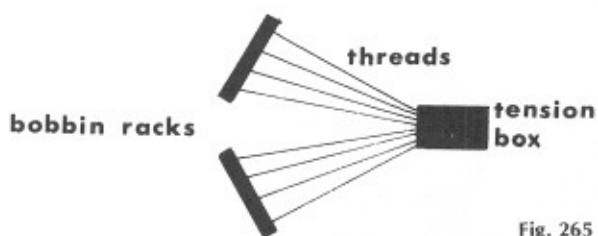

Fig. 264

Turn the pins that are beside the combs so that you can pass your threads through the combs. Take the threads from the top row of bobbins in the bobbin racks and thread them evenly through the combs going over the two remaining dowels. Take the next row of ends coming from the bobbin racks and thread them going over the dowels. Continue until the correct number of ends to fill the section have been spread through the combs. Remember that the width of the threads through the combs should be the same as the width of your section.

Be careful that your threads do not twist around each other when going from the bobbin rack to the tension box. (See Fig. 262)



Two bobbin racks, such as Leclerc No. 63621000 placed at an angle, carry the threads more evenly to the tension box.

Fig. 265

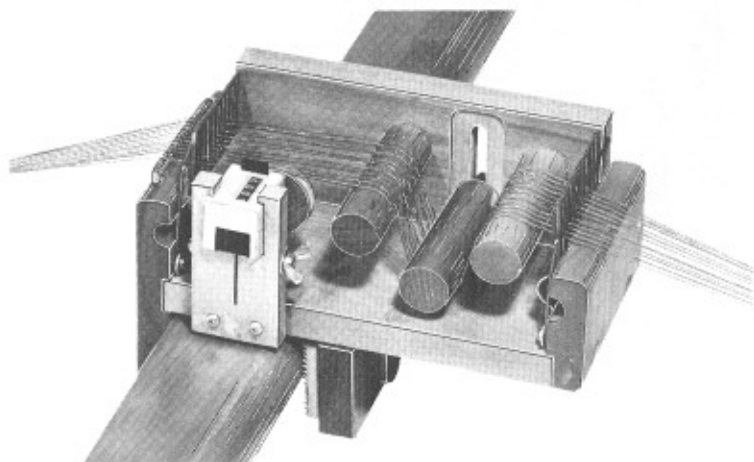

Fig. 266

Replace the center dowel on top of the threads. The tension of the warp is controlled by the depth of the loop made by the center or tension dowel, and does not necessarily have to be very great. You must be sure that the dowel is firmly attached with the wing nut, and the tension is even.

When the spools on the bobbin rack are full, they are heavier and their circumference is larger. They do not turn as fast as when they are almost empty. The faster the spool turns, the more resistance. Consequently, more tension is applied to the thread coming off the spool. As the spool empties, the tension in the tension box should be relaxed. This is accomplished by raising the center tension dowel on the tension box.

TO TIE THE THREADS TO THE BEAM

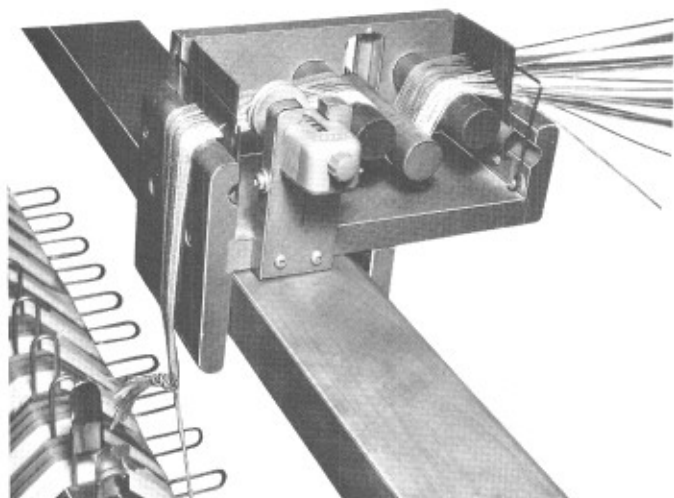

Fig. 267

One strip of the sectional warp beam has screw eyes. Slide a metal rod through these eyes. (Fig. 268)

Cut a cord about 120 cm. (48") long for each section. Double it and tie it to the rod with a snitch knot. (Fig. 268)

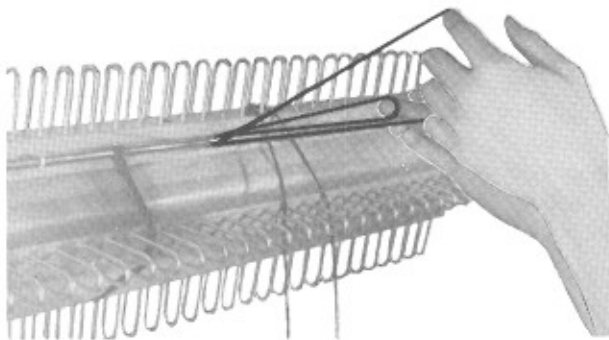

Fig. 268

Make a knot in the threads coming from the tension box, and attach it to the cord coming from the rod with a snitch knot. (Fig. 269)

Insure that the cords and knots are centered between the metal cramps. The knots should not be thick as this will cause the warp to pile on them in an uneven manner.

Attempt to maintain a steady and constant speed when winding the warp on the section. This will provide an even tension. You may guide the threads with your hand to insure they pile evenly. Be sure that the threads are spread evenly on all the width of the section. The center of the section must be at the same level as the edges. So, you have to distribute the threads evenly in the last comb of the tension box. You can guide the threads with your hands. To make it easier, use a thread guide. (See p. 32)

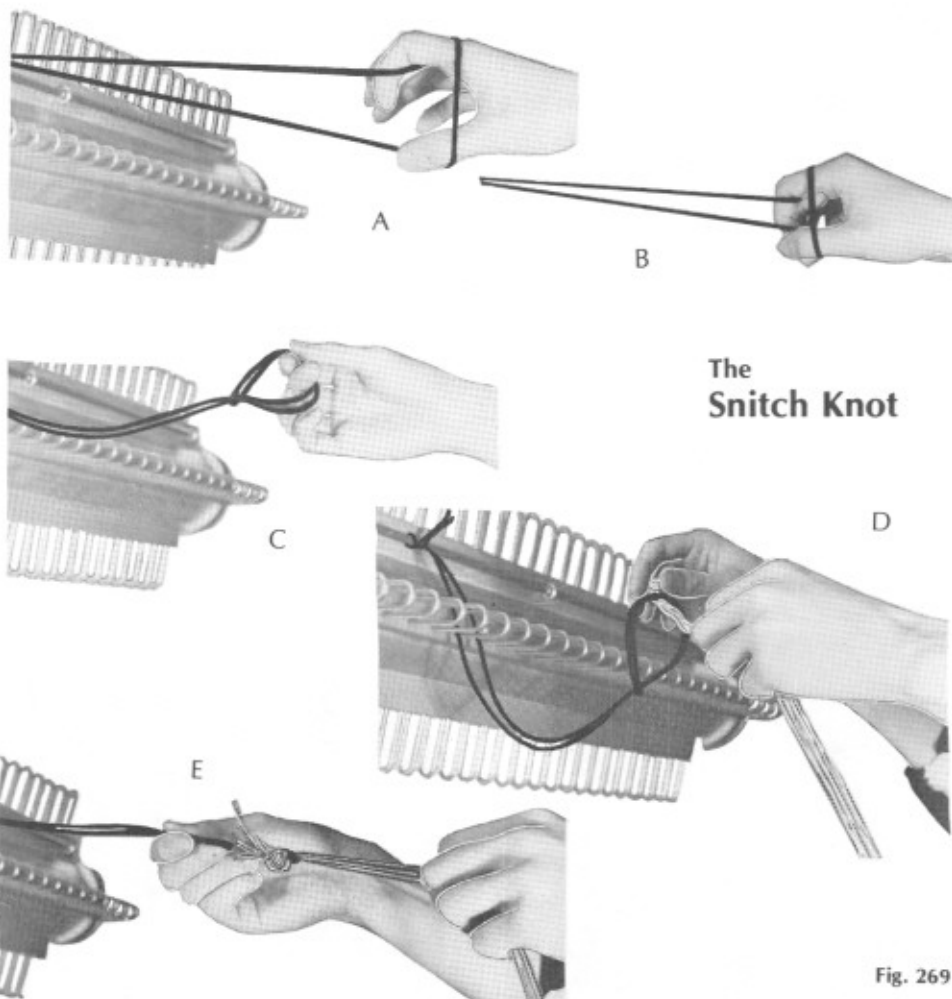

Fig. 269

There are several ways to determine the length of the warp :

- 1) The fastest way is to count the number of turns of the beam. This will give the approximate length only, because the circumference of the beam will increase slightly with each rotation.
- 2) Measure a cord of the correct warp length. Attach this cord to an empty section and allow it to wind on the beam as you warp a section. Continue winding until the pre-measured cord is completely wound on the sectional warp beam. Then, unwind the cord and repeat the same operation for the next section. This system will provide an approximate length as the pre-measured cord will be wound directly on the beam while the warp will increase in size slightly with each turn.
- 3) Use the counter as described in Figs. 273 and 274.

THREAD GUIDE

An aid to beaming is the thread guide (See fig. 270A — Cat. No. 61661000). A set of 8 guides are necessary. They slip on to the metal cramps with slight pressure and will remain in place while the beam is being rotated. They are moved from section to section as needed.

The thread guides are bent at an angle to channel the threads into the proper place during rotation of the warp beam. They eliminate the possibility of the threads hitting the top of the cramp and spoiling tension or breaking the thread.

DIVIDERS

The threads coming from the tension box should be centered in each section. It is most important to take care that the warp threads do not pile up in the center of the section and slide off at the cramps, or your tension will not be even.

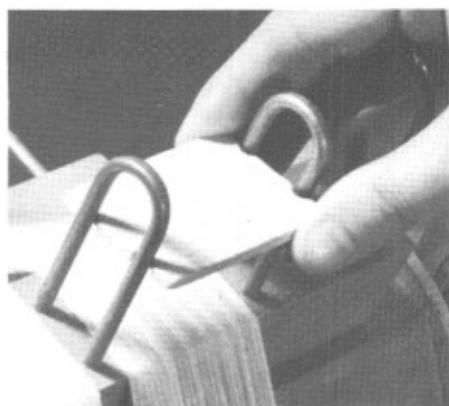

Fig. 270

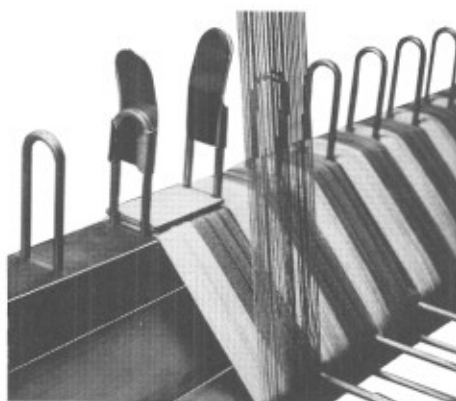

Fig. 270A

If you make long warps and have difficulty in preventing pile up in the sections, we recommend you use a divider in each section every 25 or 30 turns. They must be placed in each section at the same number of turns. It fits between the cramps, and the effect is the same as if you had started to beam a new section. (Fig. 270) (Cat. No. 61652000 for 51 mm. (2") sections. Cat. No. 61651000 for 25 mm. (1") sections.)

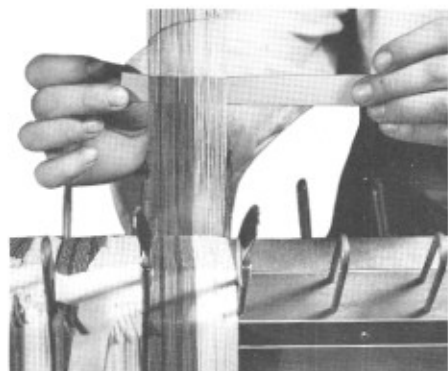

Fig. 271

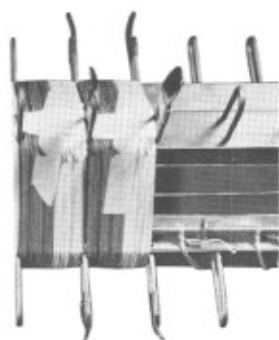

Fig. 271A

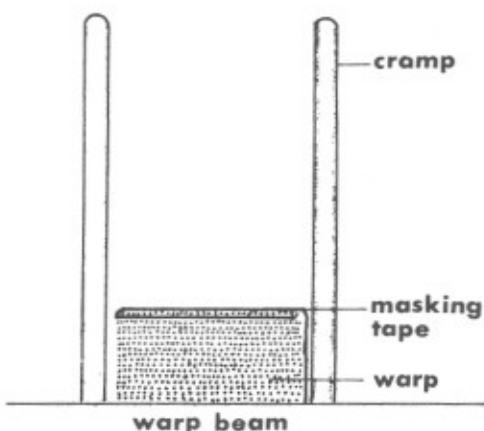

Fig. 271B

When you have wound the correct length of warp, place a piece of scotch tape or masking tape on the warp approximately 10 cm. (4 in.) from the sectional warp beam. Care must be exercised to insure that the threads are kept flat and in the same order that they come from the tension box. Before cutting the warp pull it forward sufficiently to prevent it from slipping out of the tension box. The warp can then be cut making it 10 cm. (4 in.) longer than the masking tape marker. This is your exact yardage. Masking tape can then be used to secure the end of the warp to warp wound on the warp beam for this particular section. If you desire, you may cut the warp at 20 cm. (8 in.) from masking tape marker. This will allow you enough warp to tie it in place to one of the previously filled cramps instead of taping it in place. (Fig. 271)

The tension box can then be moved to the right or left and the same procedure is used to fill the next section.

CROSSING

When warping on a sectional warp beam, a cross is not necessary if tape has been used to hold the threads in place.

If you desire to use a cross, simply hold the warp slightly in front of the tension box and pick up alternate threads or groups of threads and insert contrasting thread in the cross thus formed.

COLOR

If there are various colors in the warp, each section with the same color arrangement can be warped, skipping the sections with different color arrangements. You can return to fill the empty sections with their proper color arrangements.

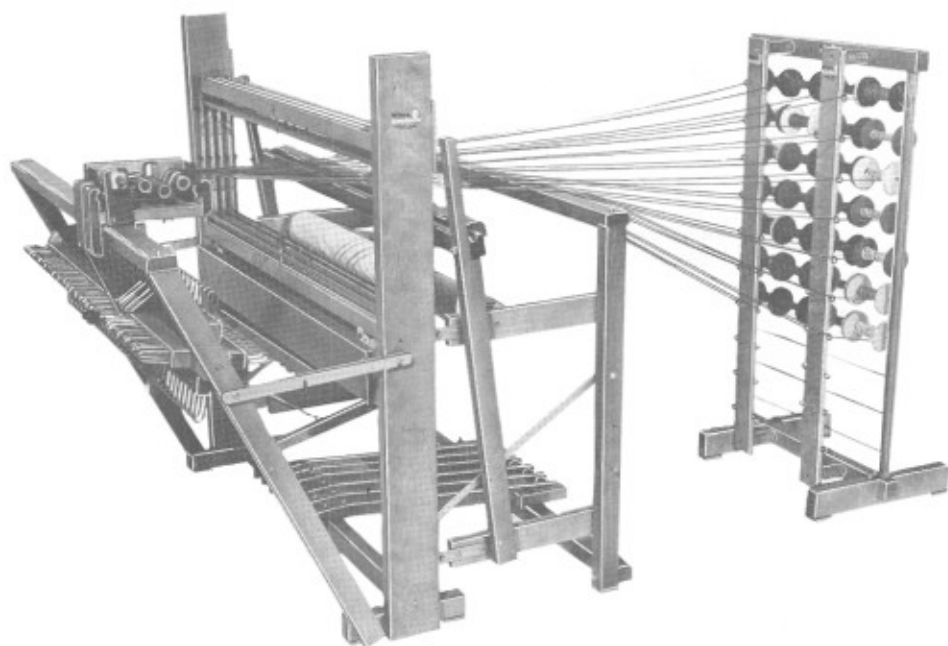

Fig. 272

If the color arrangements of some sections is the exact reverse of the arrangement of other sections, remove the tension box from the back beam after cutting the threads and fix it to the bobbin rack. Move both bobbin rack and tension box to the front of the loom. Slide the heddles out of the way, take the tension box through the harnesses, replace on the rear beam, and the order of your threads will be reversed and ready to beam. (See Fig. 272)

COUNTER

The length of the warp is usually calculated by counting the complete turns of the warp beam (either 1/2 meter or 1/2 yd.) by turn, or one meter (one yard) per turn on long warps. However, as the circumference of the beam grows, the measurement becomes inexact.

The counter No. 61606000 will give the exact measurement without the necessity of counting turns.

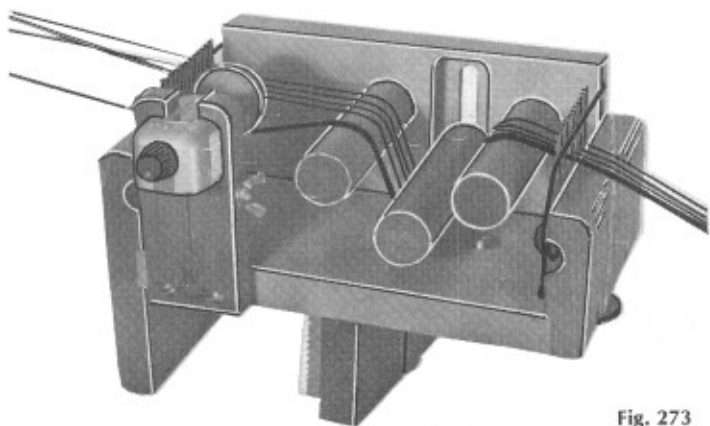

Fig. 273

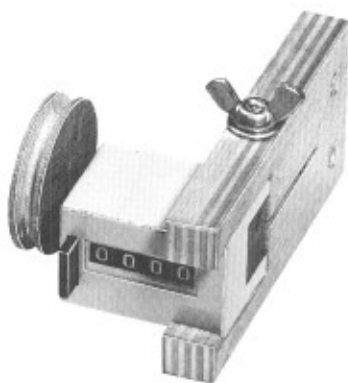

Fig. 273 A

The counter is placed on the tension box as in Fig. 273.

The warp threads pass through the tension box as previously, but one thread is used to turn the counter's wheel. (See Fig. 266)

With one thread of the warp, make 2 or 3 complete turns around the wheel of the counter to be sure that the thread will not slip on the wheel.

The counter can also be used to control the number of yards of thread on each bobbin.



Fig. 274A

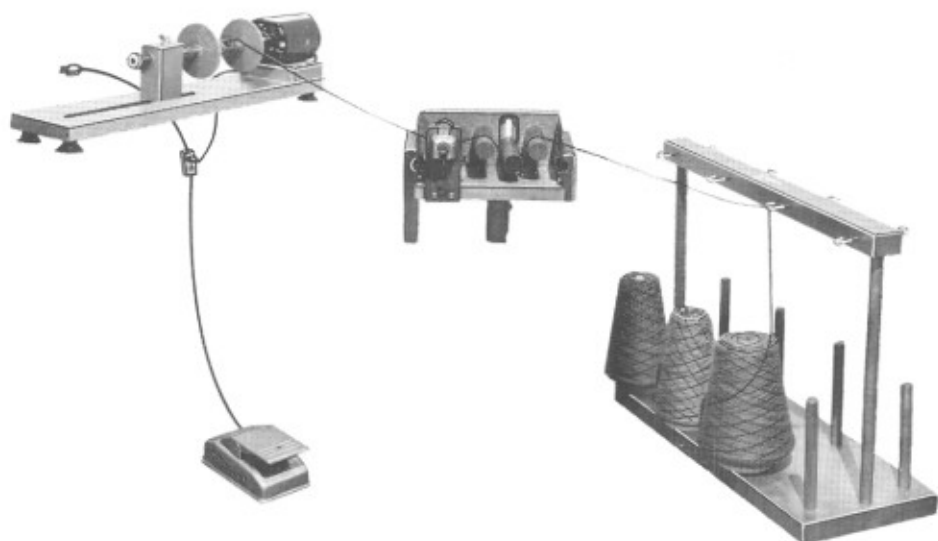

Fig. 274

Thread the yarn through the tension box, over the dowels as for sectional beaming, and around the counter's wheel (Fig. 274A). You do not have to hold the thread in your hand as the tension box will control the tension.

Generally speaking, whether winding bobbins or warping, the tension will be better if the yarn unrolls from the end of a bobbin or cone, instead of having spools turning.

B — CHAINED WARPS

We will describe two warping systems on which we make chained warps: the warping frame and the warping reel. Here are several hints, which apply to both.

The whole piece should be warped on the same day, by the same person. A change of hands or temperature would affect the tension of the warp.

Warping with two or four threads is a great time saver. Remember to keep a finger between the threads so that they do not twist.

Very wide or heavy warps can be made in two, three or more sections.

Do not slide your hand on the warp while removing it from the mill or frame. The inside threads might slip and be longer than the outside ones, creating difficulty in the beaming. The same rule applies during the beaming of the warp.

Warping on a frame or reel demands that we make crosses so that the threads remain in the same order in which they were warped. To simplify the counting of the threads, tie off the cross every 10 crosses.

Referring to our example on page 24:

If you are warping with a single thread, you need $\frac{560}{2} = 280$ crosses

Warping with 2 ends, $\frac{560}{4} = 140$ crossings

Warping with 4 ends, $\frac{560}{8} = 70$ crossings

NOTE: Care should be taken that as one tires during the making of the warp it is possible to have a great difference in tension. An occasional rest is recommended.

The same rule applies when weaving as you wish to have the beating as uniform as possible.

It should also be noted that you may encounter a difference in tension causing sticking when beaming the end of your warp. This is caused by the resistance of the bobbins as they spin faster when they grow smaller.

1. WARPING FRAME

The warping frame can be used flat on the table, or hung on a wall. The warp length is limited to 12 or 18 meters (yds.) according to the model you have. It is recommended for table looms such as Dorothy, Meco and Nilec.

Wider warps for floor looms can be made in sections.

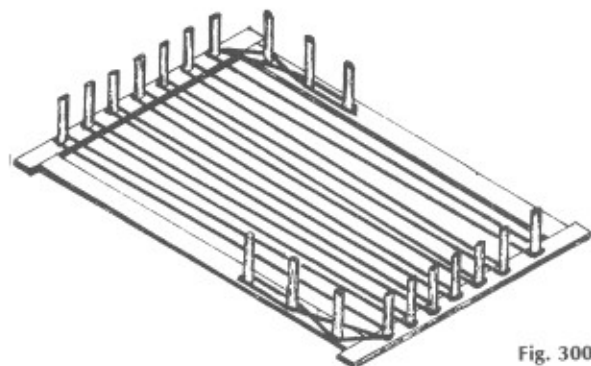

Fig. 300

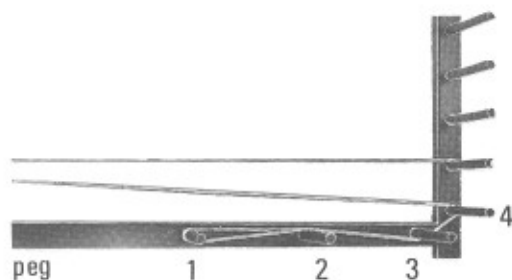

Fig. 301

After the warp length has been determined, measure it off on a frame.

Take the yarn ends coming from the spool rack and knot them together over peg 1. (Fig. 301)

Go over peg 2, under 3 and around 4, across the board and back till the desired yardage is reached. (Fig. 301)

Arriving on top pegs, go around the last peg No 4, under 3, over 2 and around 1 and reverse the procedure (under 2, over 3 and around 4). (Fig. 302)

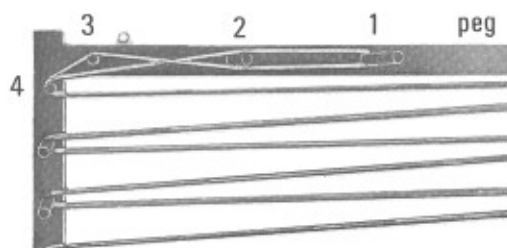

Fig. 302

Bring your threads to the bottom end, following the threads that are already on the frame.

Arriving on peg 4, go around 4, over 3, under 2, around 1 and return to the top by reversing the procedure. This will give you a cross at both ends and will simplify the beaming.

Remember to count and tie off the cross at every 10 crosses.

If you have more than one color in your warp, you must place them on the warping board in the same order you wish them in the reed. When you wish to change colors, cut threads close to peg 1 and tie the next color to the ends.

When the warping is completed, tie the two last threads together around the last peg as you did at the beginning.

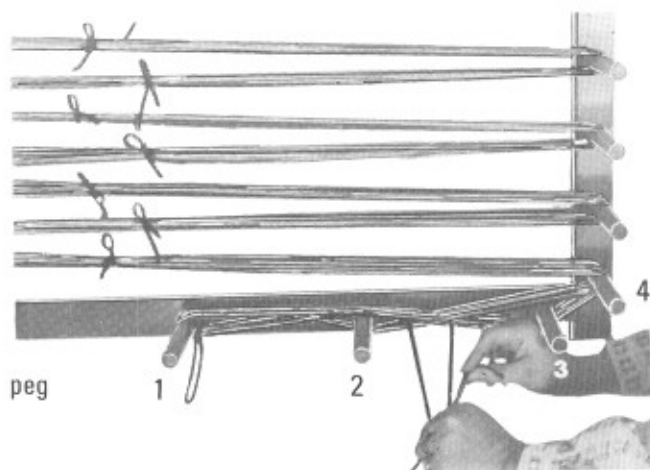

Fig. 303

Tie a string of a different color securely around the threads in the cross between pegs 2 and 3 (Fig. 303)

If the warp is not to be beamed at once, two strings tied either over or under the threads at peg 1 will keep the cross well separated.

If you have made a cross at both ends, tie firmly at both ends.

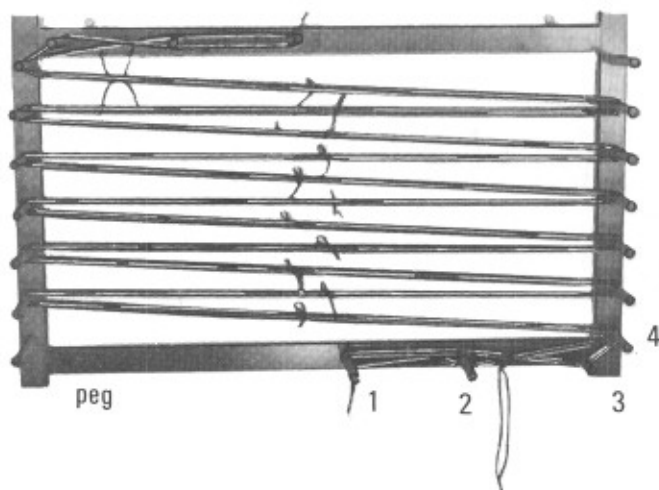

Fig. 304

Tie a string, contrasting to the color of the warp, firmly around the warp threads of every row at the center of the board. (Fig. 304)

To store your warp securely until you are ready to beam it, use either the "BASKET" or the "CROCHET" (also called chained) method.



Fig. 305

Remove the warp from the board (fig. 304) or the reel (fig. 324) by grasping the warp firmly and slipping the loop off the end peg.

Basket Method:

Roll the warp up in a basket, having the warp turning one row on top of the other. (Fig. 305)

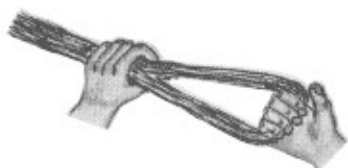

Fig. 306



Crochet Method:

Place the right hand through the loop and grasp the entire warp pulling it through to form another loop. (Fig. 306) Continue by chaining hand over hand until you reach the crossing. Do not pull the end of the warp (cross) through the loop when finished, but tie the last loop with a string.

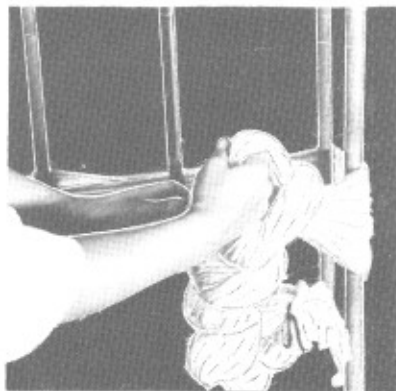

Fig. 307

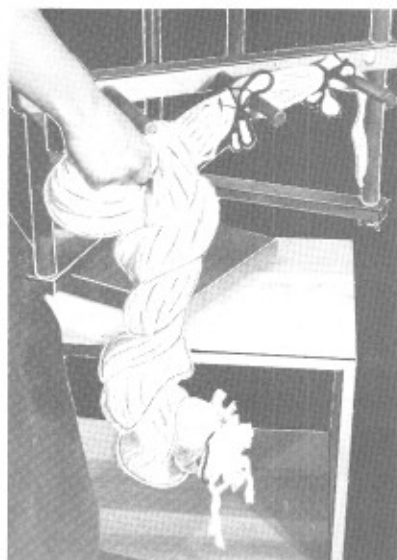

Fig. 308

2. WARPING REEL

The vertical warping reel is recommended for warps with many colors and textures of threads. More than 10 spirals on the reel are not recommended, until you have some experience with this type of warping equipment.

Leclerc offers three kinds of vertical warping mills: a first one on which you can warp 20 meters (20 yards), i.e. 1,83 meter (2 yards) per turn, a second one on which you can warp 30 meters (30 yards), i.e. 2,75 meters (3 yards) per turn, and a third one on which you can warp 40 meters (40 yards), i.e. 3,66 meters (4 yards) per turn. (Refer to the Leclerc catalogue.)

Detach removable pieces at both ends of crossing pieces. (Fig. 320)

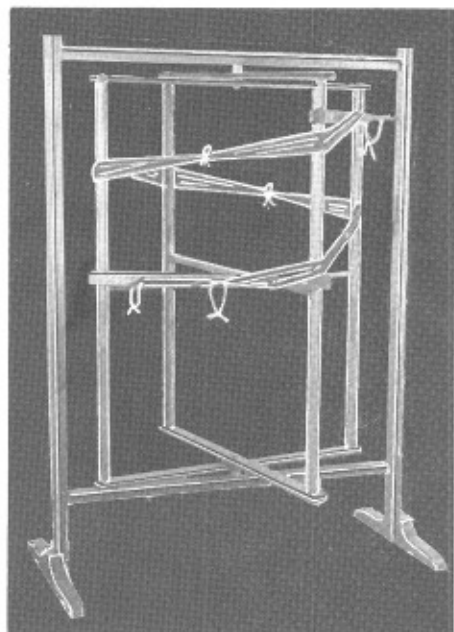

Fig. 321

Tie the ends of the threads coming from the spools to the end peg of the lower crossing. Following the guide thread, wind upwards in a spiral form. (Fig. 322)

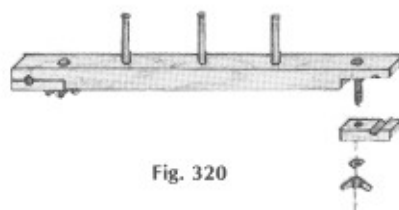
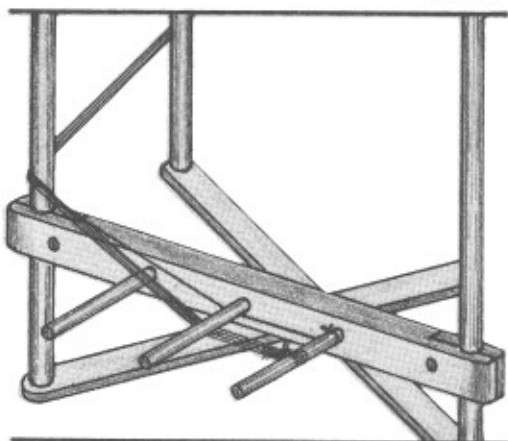

Fig. 320

Place groove of top crossing piece around upright pieces at the height that is convenient for the length of warp. Replace the removable pieces using the wing nuts.

Use a guide thread (different in color or texture from your warp) measured to the length of your warp wanted, to determine where the lower cross-piece should be placed and attach as before. (Fig. 321)

Fig. 322



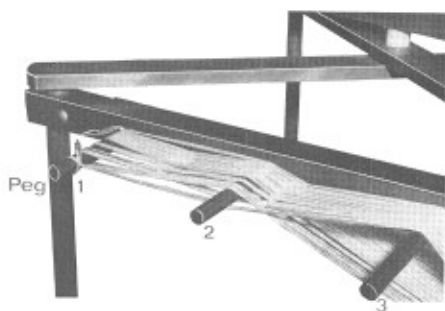

Fig. 323

When the top cross-piece is reached, make a cross in the form of a figure 8, always in the same direction; over the third peg, under the second, around the first, returning over the middle peg and under the third. (Fig. 323)

Return your threads close to those you have just placed, this time making the spiral towards the bottom.

Make another cross in the form of a figure 8 as you did on top of the reel and start the upward spiral (See Fig. 324)

When your warp spreads to wide on the reel, place the threads very close by hand, to get free space to continue to **WARP DIRECTLY ON THE WOODEN FRAME OF THE REEL**. Continue until you have the desired number of threads, remembering to tie your threads every 10th crossing for easier counting.

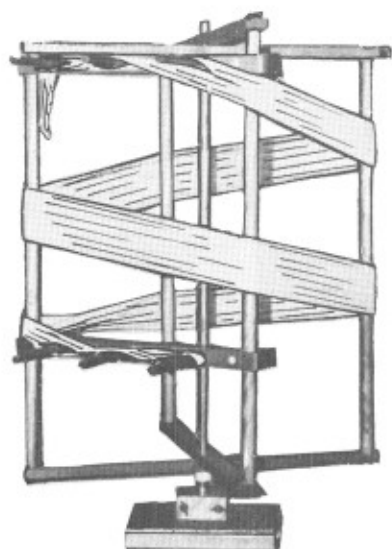

Fig. 324

If you have more than one color in your warp, you must place them on the warping mill in the same order you wish them in the reed. Always change color at peg 1, cutting ends and tying the next color to the ends.

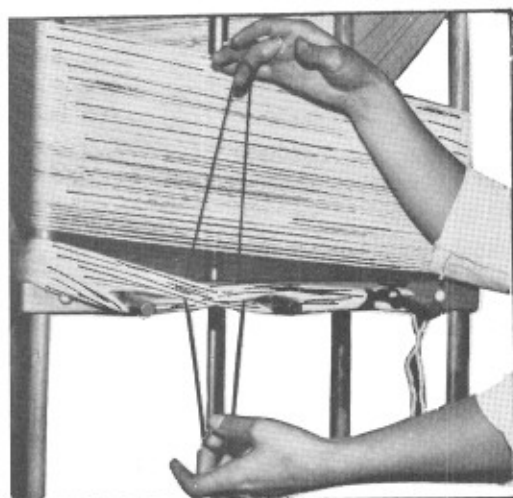

Fig. 325

Tie a string securely in the cross, the string long enough to allow to spread the warp on the width of reeding (example: 55 cm. - 22 in.).

We suggest that you tie the warp tightly at every turn of the warping mill. This will prevent the threads from sliding when beaming. (Fig. 326).

To remove the warp from the reel, grasp the warp firmly and slip the loop off the end peg.

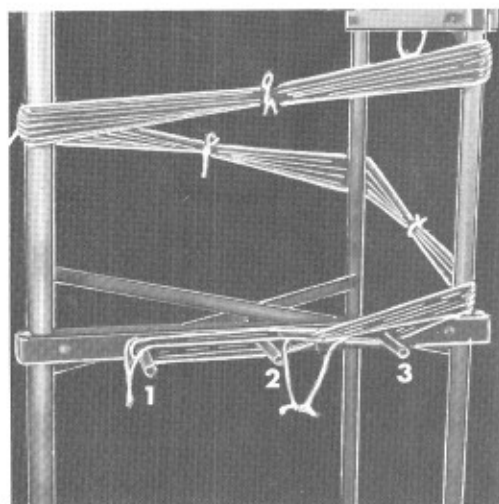

Fig. 326

To store your warp securely until you are ready to beam it, you can use either the basket or the crochet method to take the warp off the reel (see page 40).

VIII RADDLE OR SPREADER

This is an open comb with 1 dent per cm. (2 dents per inch) and is used to spread the warp for beaming. It is used in the space normally holding the reed.

When you use a warping frame or a warping reel, you have to beam the warp, spreading it the width it will be on the reed — which is the width of your finished material — plus up to 5% shrinkage.

To simplify this operation, use a raddle of one dent per cm. or 2 dents per inch.

To use the raddle, remove the batten handtree of the beater, put the raddle in the batten sley and tie it firmly to the batten sley with a string.



Fig. 340

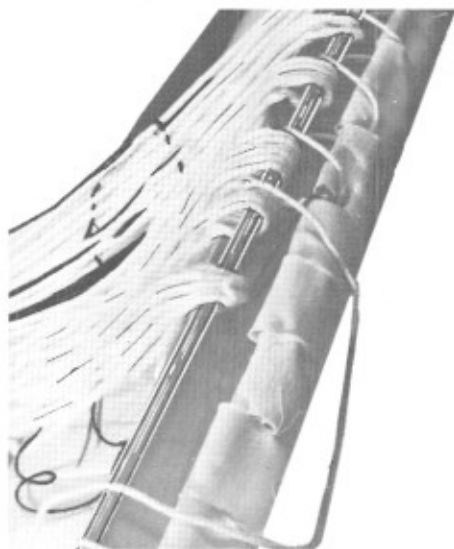

Fig. 341

Place a piece of long narrow cardboard folded lengthwise across the top of the pins of the raddle. This will prevent the warp from falling into the sections of the raddle before you are ready. Masking tape may be used to hold the cardboard in place.

Insert the iron rod through the loops formed by the cross at the end of the warp. Secure both ends of this bar with cord to the warp beam apron bar or perforated wooden stick depending on the style of loom. Be sure to spread the warp evenly to the same width as you wish to weave. Now lace both bars together. (Fig. 341)

You can also cut the loops and tie the warp in small bundles directly to the apron rod.

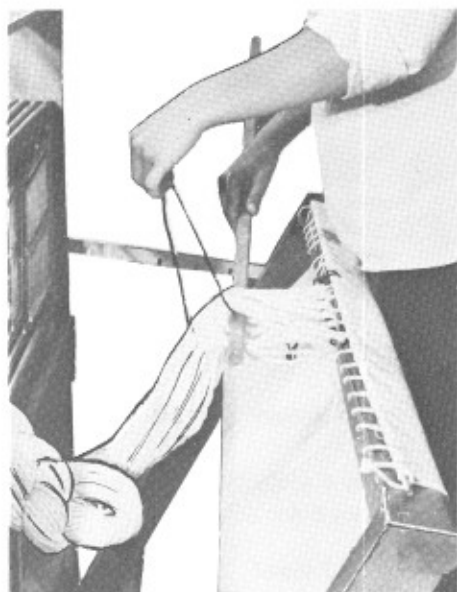

Fig. 342

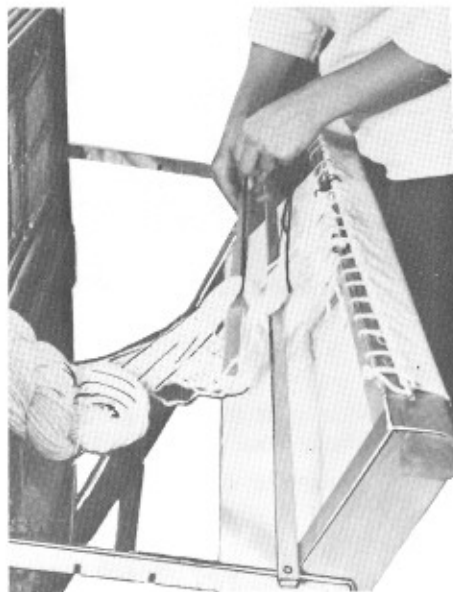

Fig. 343

Insert the lease sticks (cross sticks) (steel, wooden or plastic), which come with the loom, through the loop in the crossing which has been tied with string up to this point. (Figs. 342 and 343)



Fig. 344

Tie the lease sticks together at both ends and remove the string which has secured the cross at this end. (Fig. 344)

The threads will go over and under the lease sticks in the same way in which they were warped, either 1 thread over and 1 under, 2 threads over and 2 under or 4 threads over and 4 under. (Fig. 345)

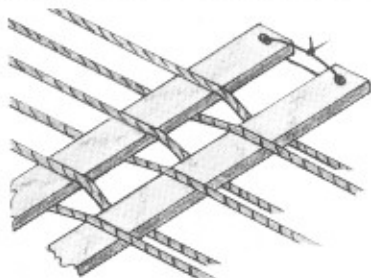

Fig. 345

Next tie both ends of the lease sticks to the thread beam and to the castle of the loom. (Fig. 356)

Place the warp in the raddle by gradually sliding the folded "V" shaped cardboard to the side. (Fig. 346)

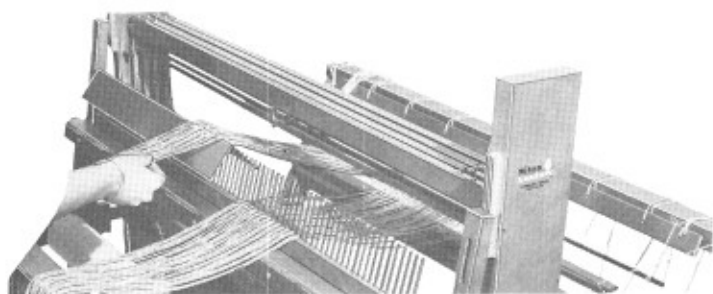

Fig. 346

Divide your threads so that there are as many threads per cm. or inch in your raddle as your planned sett per cm. or inch.

For example, if you have made your warp with 4 ends, there will be 8 ends in each cross. If your sett is ten ends per cm., you can put:

	2 dents with one cross in each	(2 times 8 threads)
Next 2	" " 1 1/2 " " "	(2 " 12 ")
" 2	" " 1 " " "	(2 " 8 ")
" 2	" " 1 1/2 " " "	(2 " 12 ")

Thus, your threads are placed as follows: 8 threads, 8 threads, 12 threads, 12 threads, 8, 8, 12, 12 and so on.

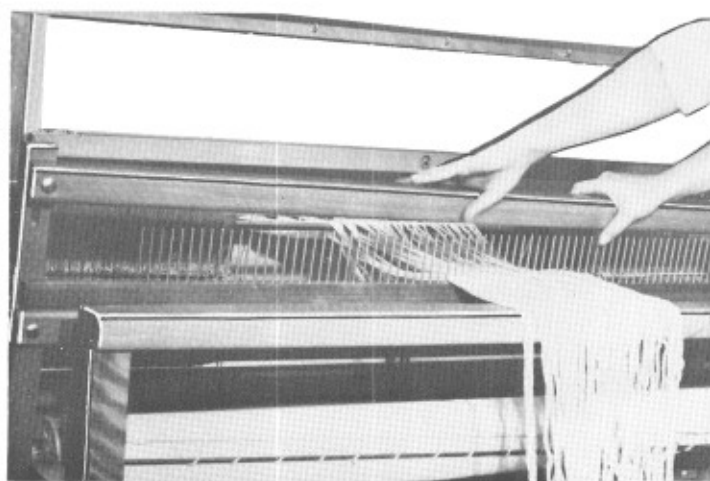

Fig. 347

Replace the batten handtree to close the raddle and prevent the threads from coming out of the dents. (Fig. 347).

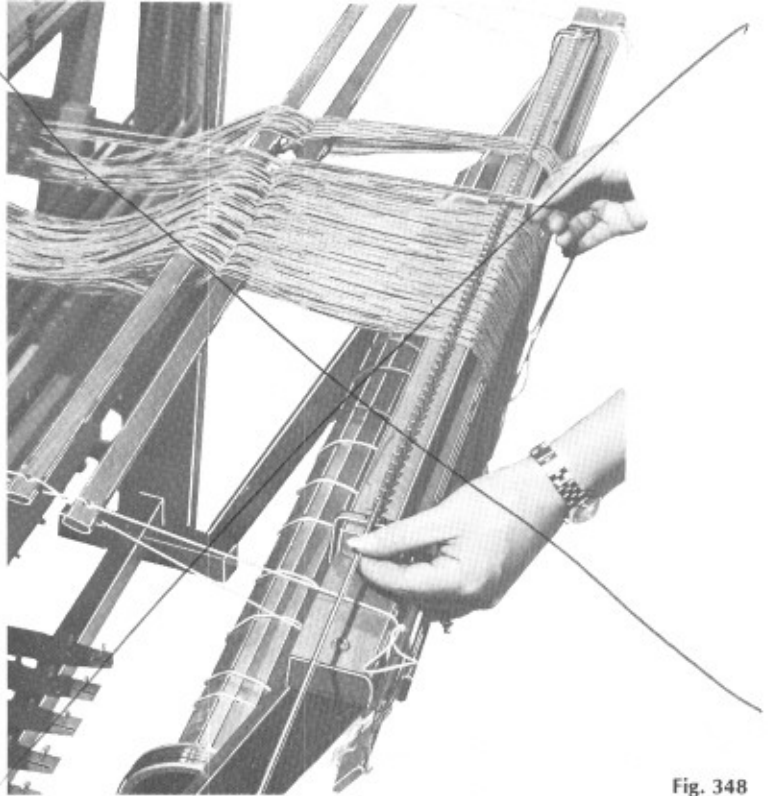

Fig. 348

No LONGER AVAILABLE

A **new raddle** is now available which is placed on the slabstock of the loom. This position brings the raddle closer to the beam and enables an even better beaming of the warp.

This raddle can be closed by slipping an iron bar through the cramps.

Now refer to the bottom of this page to do the beaming.

When the beaming is completed, insert the lease sticks in the second cross. Tie the lease sticks at both ends and bring them close to the harnesses by using a threading helper (Fig. 372) or tie them between the slabstock and the upright pieces (Fig. 356).

BEAMING

Be sure that you have another cross at the other end of the warp. If so, you can remove the lease sticks for beaming. This will prevent threads from sticking.

Try to avoid pulling or combing the threads while beaming. Place yourself a few meters in front of the loom and shake the warp to untangle it.

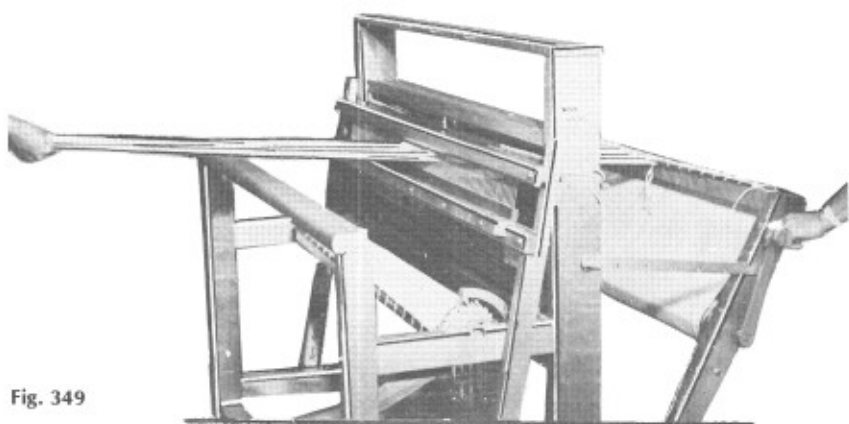

Fig. 349

The person holding the yarn under tension should be at a reasonable distance from the loom so that the angle of the selvedge threads is not too pronounced.

If the threads stick together, a third person may be required to carefully separate them using both hands. (Fig. 350)

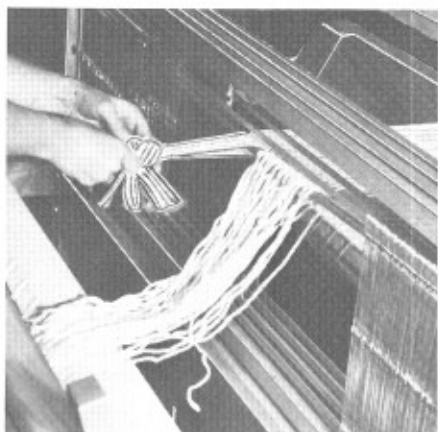

Fig. 351

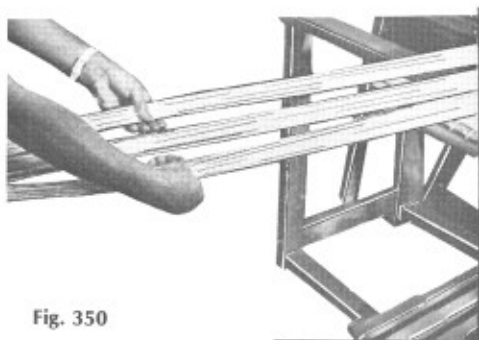

Fig. 350

You can either tie the warp in small bundles to the apron rods for beaming, or insert one rod through the loops and lace it to the other rod in the canvas apron.

Use warp sticks or strong paper to separate the layers of warp as they are rolled onto the beam.

If you are using more than one size or type of yarn in your warp, you may have difficulty with your tension, due to the different elasticity of the various yarns. This may not appear until a meter or so of fabric has been woven. The best solution is to beam each type of yarn separately, using an extra warp beam. If the whole warp is rolled on one beam, pick up the loose threads at the back of the harnesses on a strong rod, slide it under the warp beam, and suspend weights from it until you have the correct tension. (See Figs. 495 and 496)

THE USE OF A REED INSTEAD OF A RADDLE

If you do not have a raddle, it is possible to use the reed to spread the warp. However, this method is not recommended for the following reasons:

- A) Too many threads sliding in one dent damage the reed.
- B) This system causes threads to stick together and undermines the tension.
- C) Threads can be broken. It is difficult to beam evenly and some of the shorter threads will cause difficulty during the entire weaving.

However, if you wish to use the reed in place of a raddle, here is the way:

- Do not use more than 2 bobbins when warping in order not to have more than 4 threads in one dent.
- Insert the lease sticks the way described on page 45
- Tie the cross sticks to the front breast beam. Sley the crosses through the reed in groups of threads, leaving empty dents, so that there are as many threads per cm. or inch as you planned to sley.
- Refer to page 44 to insert the iron rod through the loops.
- Then, do the beaming as on page 47.

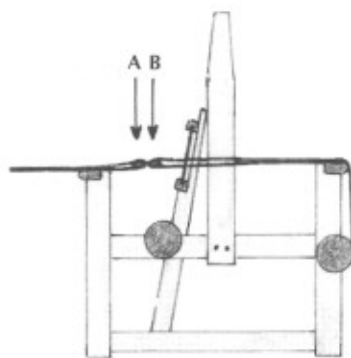

Fig. 352

When the beaming is completed, insert the lease sticks through the second cross which is at the front of the loom. You must transfer it to the rear. To transfer the cross of the warp to the rear of the harnesses, follow the steps on Figs. 353, 354 and 355.

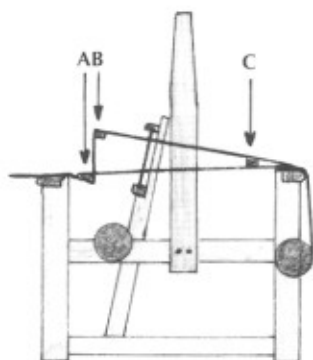

Fig. 353

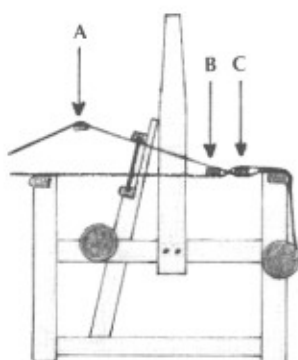

Fig. 354

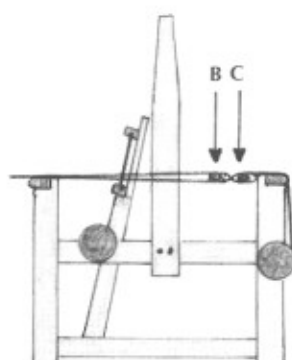
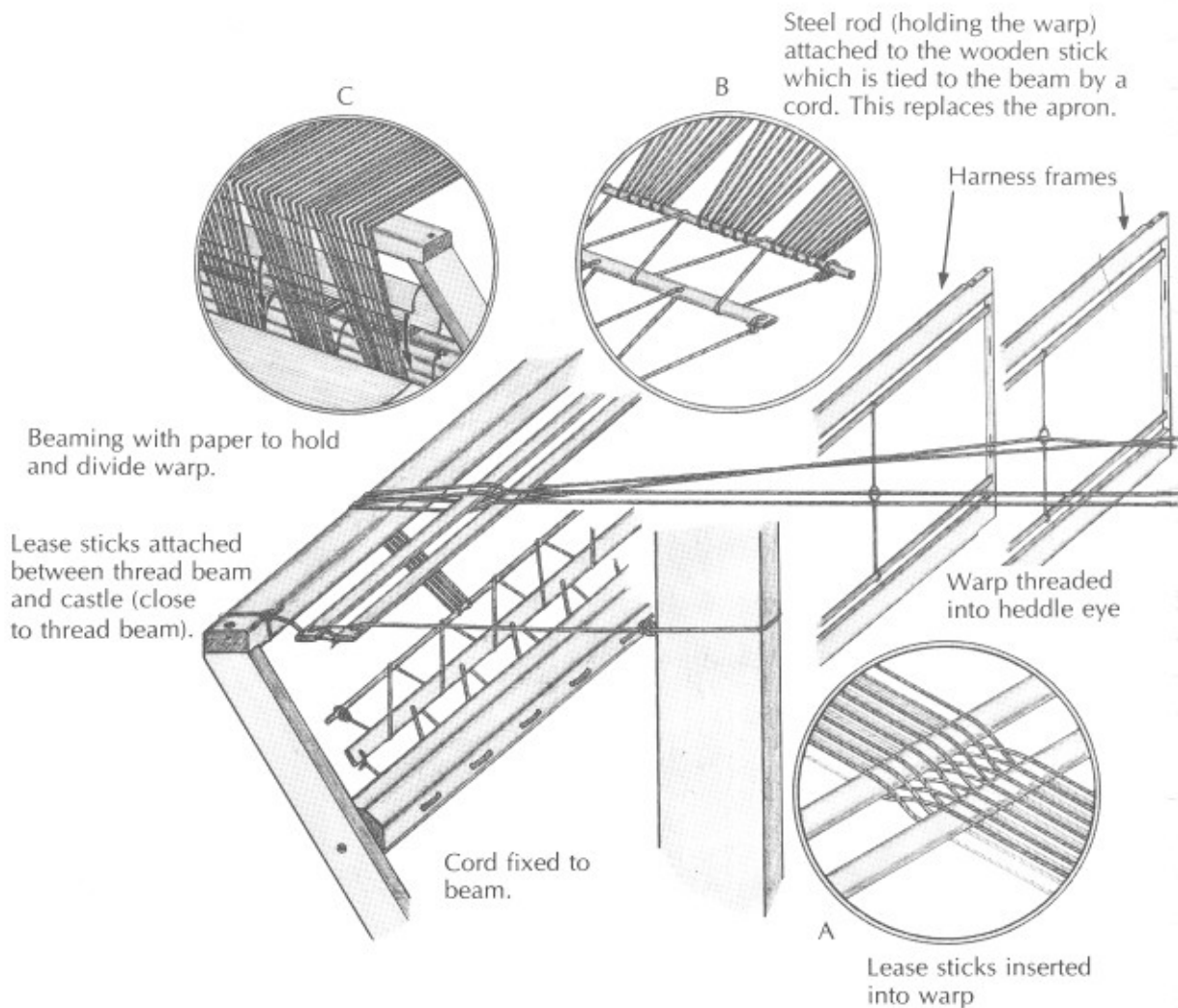

Fig. 355

A and B are your regular lease sticks. C is a newly inserted lease stick made possible by lifting B. (Fig. 353)

B is taken out, lift A, place B in new position (Fig. 354). Take out A. (Fig. 355)



The use of wooden sticks and cords prevents the stretching of apron when the loom is not warping at the full width.

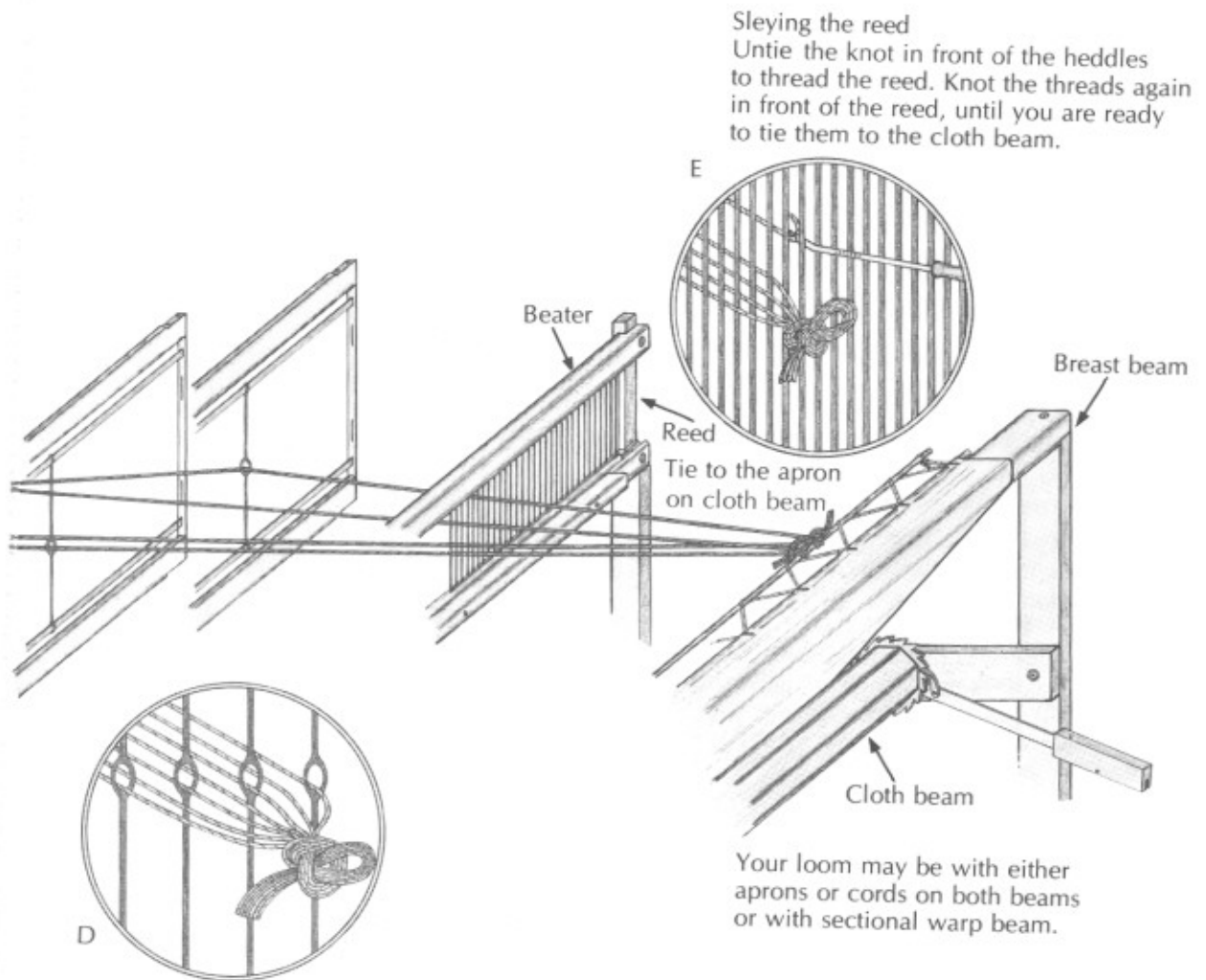

Sleying the reed
 Untie the knot in front of the heddles to thread the reed. Knot the threads again in front of the reed, until you are ready to tie them to the cloth beam.

D
 After threading a small bunch of warp ends, make a slip knot to prevent the warp from slipping back.

Your loom may be with either aprons or cords on both beams or with sectional warp beam.

Fig. 356

IX THREADING

After your warp has been beamed, your loom is now ready for threading. This is accomplished in conformity with your pattern. (Chapter XI) Threading the loom can be a long and tiring process. Sit as close as possible to the harness frames. Insure that the harness frames are at the proper height to avoid unnecessary bending. It is well worth the time and trouble required for preparation to insure that you can thread as comfortably as possible.

Use an ordinary chair, they are usually found to be the correct height. A weaving bench will be too high.

On Leclerc foot power looms, except Artisat, remove the front breast beam, the cloth beam, the batten handtree and the reed.

Make sure the lams are not tied to the treadles (Fig. 370)

On a jack loom, raise your harnesses to a comfortable level by putting board, books, etc. under the harnesses. (Fig. 247)

On a counter-balanced loom, raise the harnesses by tying cords around the top roller and the small rollers will lift up (about 15 cm. — 6 in.)



Fig. 370

If your loom is a folding model, bring your thread beam as close to the heddles as you can, with the lease sticks tied to the back thread beam.

If your loom is rigid, slide the lease sticks along the suspending cords tied between the thread beam and the upright posts.

Unhook the heddle bars from the center heddle bar supports, so that the heddles may now slide freely from one side to the other.

If you start threading from the right, slide all of your heddles to the left. If you are working on a narrow warp, leave some of the heddles free on the right side so that upon completion of the threading you do not end up with all of your free heddles on one side of the harness frame.

Your warp must be centered on your loom as this permits an event beat.

With a reed hook, pull the warp end through the heddle eye from back to front. Take them in the same order as warped, being careful not to cross them.

Check every 20 ends to see that the draw-in is correct.

Tie the warp ends in small groups in front of the heddles as you thread, so that they can not slip back through the heddles. (Figs. 356 and 371)

Never pass a thread in more than one heddle.

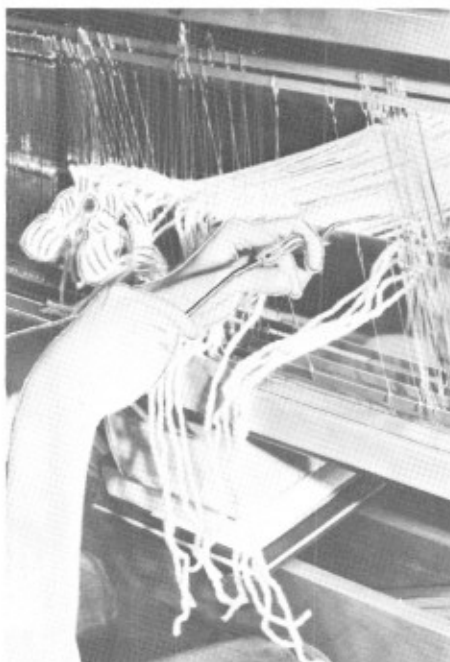

Fig. 371

A **THREADING HELPER** is helpful when threading the loom.

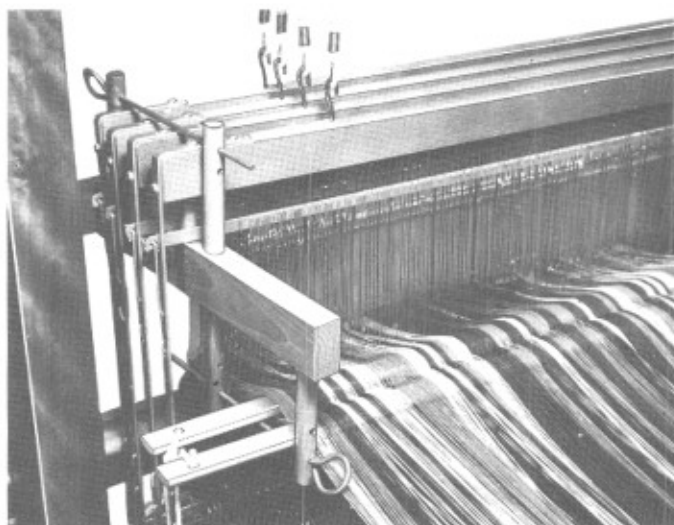

Fig. 372

It holds all the harnesses at the same level while threading the loom, and holds the lease sticks at the right height and distance for easy threading. (For 4-harness foot-powered Leclerc loom — Cat. No. 61474000)

SLEYING THE REED

After all the warp ends have been threaded, they have to be sleyed through the reed. Your warp must be centered in the reed. Find the center of the reed. If your warp width is 60 cm. (24 in.), you start sleying 30 cm. (12 in.) from the center.

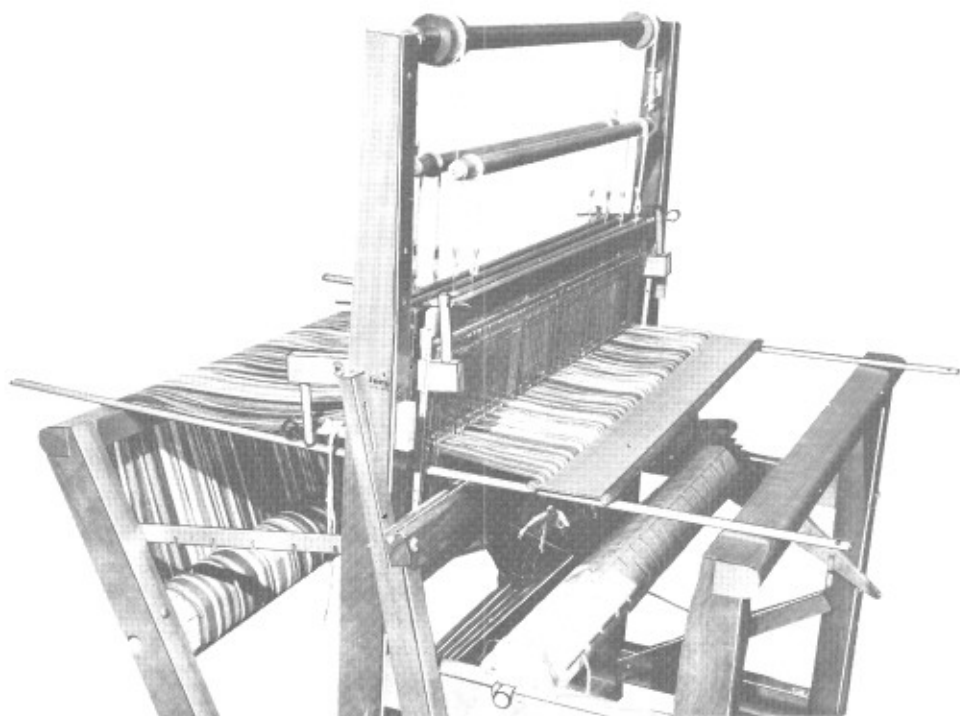

Fig. 373

Replace the front breast beam. Place two sticks between the heddles at each side of the loom. Place the reed flat on these sticks (Fig. 373).

Place the threads on top of the reed, and taking them in the order in which they were threaded, push down the correct number of threads through the dent with the back of the hook.

If our planned sett is 4 ends per cm., we should use a 2-dent reed, and sley 2 ends per dent.

If you have an inch-reed, the example would be: for a sett of 10 ends per inch, use a 5-dent reed and sley two ends per dent.

After about 10 dents, pull the threads in place and check to make sure they are sleyed correctly. Then divide this group in two and make a single knot to prevent them from sleying back.

Another way of sleying the reed is to pull the threads through the reed with a reed hook from underneath.



Fig. 374A

Sleying the reed by pushing the thread from top.



Fig. 374B

Sleying the reed by pulling the thread with hook from underneath.

Both methods of sleying the reed are equally good. Use the method you feel most comfortable with.

When the whole warp has been sleyed, replace the reed in the batten sley and replace the batten handtree.

Lower the harnesses to their normal height, put the heddles support back into the central hooks.

Return the tension to the brake on the rear beam by releasing the brake treadle. (Page 88)

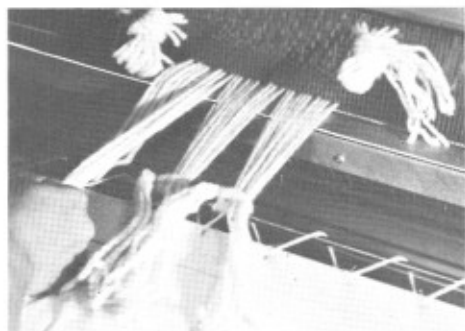

Fig. 375A

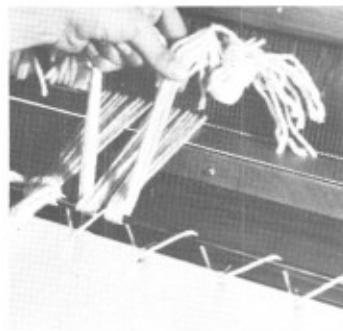

Fig. 375B

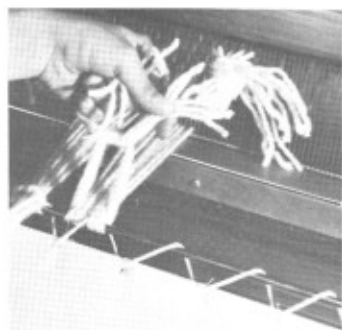

Fig. 375C

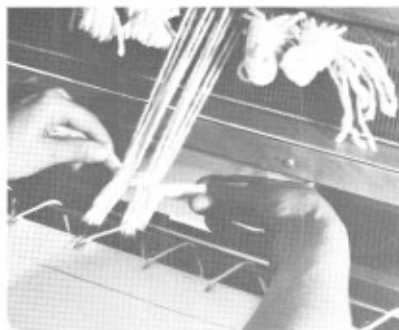

Fig. 375D

Tie the sleyed warp to the steel rod in front of the cloth beam apron. Note that one steel rod goes through the canvas, and the second steel rod is attached to the first.

Divide the threads in small groups (about 13 mm — 1/2" wide). Pass a group over the rod. Divide the group in 2 parts and tie the 2 parts together over the threads. Begin at the center, then right outside, left outside and fill in.

When you have finished, make sure that all the groups are tied at the same tension by running your hand over the top of the warp in front and back of the loom. If you find any loosening of tension, pull the single thread or group and adjust it in the knot. Then make double knots so they won't loosen while being woven.

X WHAT IS WEAVING

Weaving is done by interlacing the threads of the warp with those of the weft.

The interlacing of warp and weft threads is done in two ways:

- A) **Rising shed:** treadle 1, tied up to harness 1, is pressed, thus raising harness 1. Jack-type looms are rising shed looms.
- B) **Lowering shed:** treadle 1, tied up to harness 1, is pressed, thus lowering harness 1. Counter-balanced looms are lowering shed looms.

WEAVING WITH TWO HARNESSSES

Weaving can be done with 2 harnesses. One harness carrying the odd numbers and the other harness carrying the even numbers of threads. The harnesses being raised one after the other to make the shed for the passing of the shuttle.

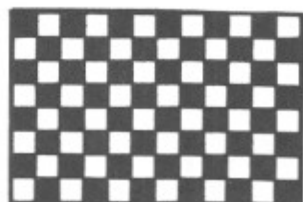

Fig. 385A



Fig. 385

With only two harnesses, you are limited to plain weave or tabby. (Figs. 385 and 385 A)

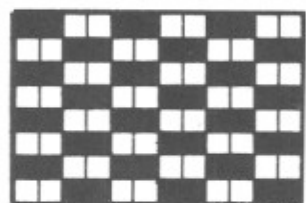

Fig. 385B

Passing two threads on the first harness and two threads on the second harness and repeat will give Basket Weave. (Fig. 385 B)

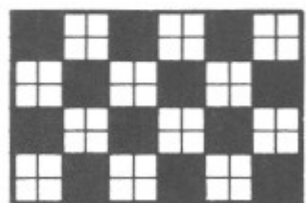

Fig. 385C

Using two shuttles and passing them on the same shed will also give Basket Weave. Consider that the warp is made with threads of one color and the weft threads are of another color. (Fig. 385 C)

Using professional weaving language, a black square on the draft is called a “float” — it represents the weft thread that goes over the warp thread at a predetermined place. A white square is called “taken” — it represents the weft thread that goes under the warp thread at the same place.

If this threading is made with three or four threads on the same harness and an equal amount of threads is passed through the shed, you get the following pattern.

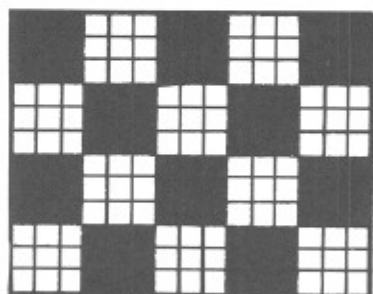

Fig. 386A

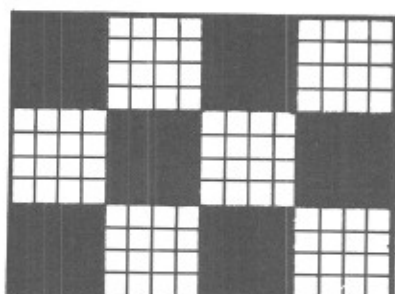

Fig. 386B

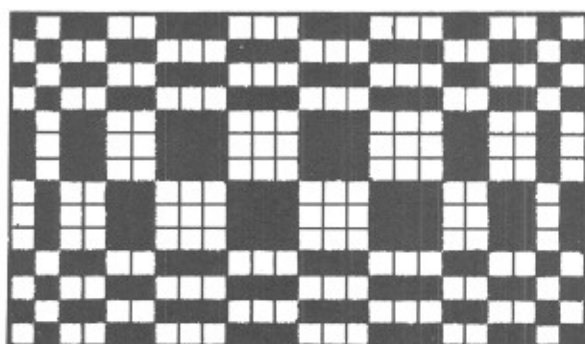

Fig. 386C

This pattern is made with groups of various numbers of threads in the harnesses and in the shed.

We should not have too many threads passing together on the same harness or the same shed as it will result in a long float and it will not be a durable weaving.

For more variety, consider experimenting with colors in the warp as well as the weft.

WEAVING WITH FOUR HARNESSSES

With four harnesses, the possibilities are numerous. In addition to the variation on a same threading by different treadling, we have the possibility of variations in the threading.

The way in which the threads interlace depends on the way the warp threads are threaded through the heddles, and this operation is called threading. This is the foundation. From a simple and continuous threading, more than sixty-four weaves can be achieved.

The combination of threading and treadling, which makes a solid cross of threads placed in both directions, is called fabric.

With seven notes and various octaves of music and infinity of sounds can be created; with four heddle frames and six treadles, on which the tie-up can be changed at will, plus pick-up, leno, and a variety of fibers and colors brought together in the same weave, the field of imagination and creativity is endless.

Before attempting to weave on eight or twelve harnesses, it is important to understand four-harness weaving thoroughly, and this requires a lot of study and practice.

The evolution of threading and patterns produced by various treadlings will be explained in this chapter. It is impossible to explain them all in detail, but the important elements will be described.

In this book, all the threadings are read from right to left and are shown by four rows of squares, which represent the four harnesses (six rows for treadles). The large X in these squares indicates where a thread should go through. It is necessary to follow the instructions exactly. In a continuous pattern we proceed from right to left, then return to right again. The directions may sometimes specify a return from the center from right to left instead of reversing the pattern to make the other half; this method gives the same result as if we repeated the draft.

Handweaving stirs the imagination and captivates the weaver. A large variety of different designs can be made with the same threading, and by changing the tie-up and treadling order, up to forty-eight different twill weaves can be created.

Example: Instead of using the conventional tie-up — 1-3, 1-2, 2-3, 3-4, 1-4, 2,4, — the tie-up can be made so that there is only one harness rising, or three rising at the same time. The designs thus obtained are often pleasing, but they are sometimes impractical when the floating threads are too long.

When choosing a pattern in any book, it must be remembered that the author is describing his own achievements. Using other looms, thread count, different weaving methods, etc. might give different results.

Twill threading, one of the easiest, is done by following the order 1-2-3-4, that is: thread first heddle for the first harness, second heddle for the second harness, and so on, or 4-3-2-1 (beginning with the last harness and threading heddle 4 and continuing in this manner to the first harness).

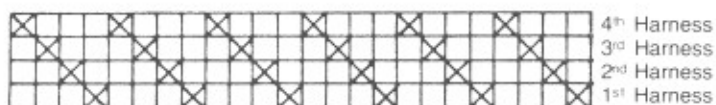

Fig. 387



Fig. 388

Basket weave threading is achieved by repetition of each heddle: 1-1-2-2-3-3-4-4, 1-1-2-2-3-3-4-4, and repeat

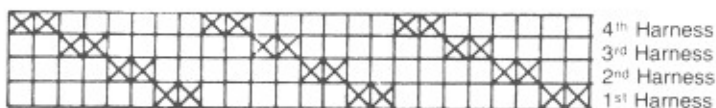

Fig. 389

Bird's eye threading: 1-2-3-4-3-2, 1-2-3-4-3-2, and repeat. Here, the heddles of harnesses 1 and 4 are used less often, so that there are less threads rising on harnesses 1 and 4.

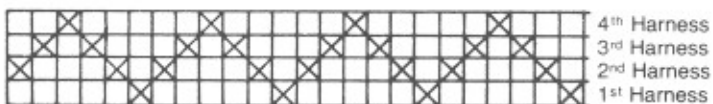

Fig. 390

Chevron threading: 1-2-3-4-4-3-2-1, 1-2-3-4-4-3-2-1, and repeat

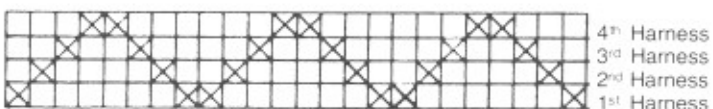

Fig. 391

Swedish Rose Path threading: 4-3-2-3-4-1-2-1, 4-3-2-3-4-1-2-1 and repeat



Fig. 392

Satin weave threading: 1-3-2-4, 1-3-2-4, and repeat

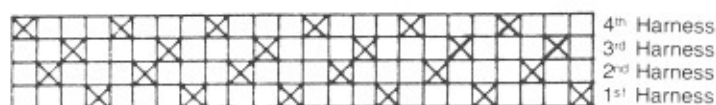

Fig. 393

Broken twill threading: 1-2-1-3-2-4-3-4-2-3, 1-2-1-3-2-4-3-4-2-3 and repeat

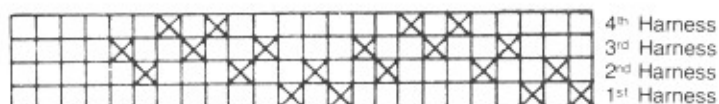

Fig. 394

Block design threading: 1-4-2-4-1-3-2-4-1-3-2-4-1-2-1-2-1-2-1-2-1-2 and repeat. Repeating the threading will give squares.

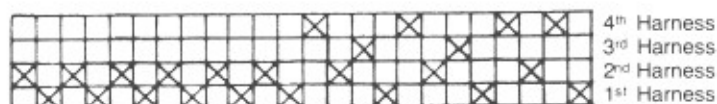

Fig. 395

Regular Block threading: 1-2-1-2-1-2-3-2-3-2-3-4-3-4-3-4-1-4-1-4 and repeat



Fig. 396

Interrupted Block threading: 1-2-1-2-1-2-1-2-1-2-3-4-3-4-3-4-3-4-3-4 and repeat.

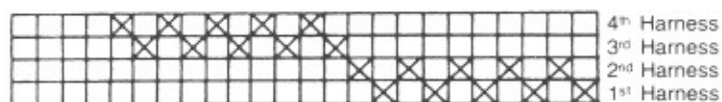

Fig. 397

Block threading, thread-to-thread: 1-3-2-3-1-4-2-4, 1-3-2-3-1-4-2-3 and repeat.

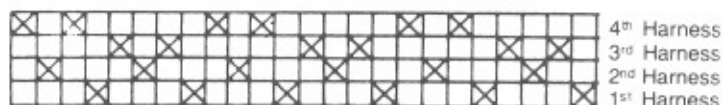

Fig. 398

Interrupted threading: 1-2-4-3-1-3-2-4, 1-2-4-3-1-3-2-4 and repeat.

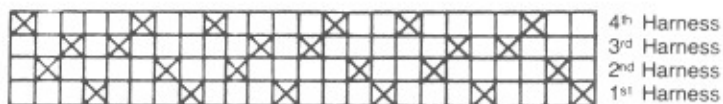

Fig. 399

Ever since weaving started, different countries have developed their own characteristic methods and have expressed by specific graphic designs their personal threadings. It is important to be able to read any threading.

The modern diagrammatic system most often used for weaving, especially North American weaving, is composed of five lines and four squares. Harnesses 1-2-3-4 are represented by the four squares 1-2-3-4, from bottom to top. Reading is from right to left, in the same order as the squares. Each square is numbered on the right side of the diagram to indicate the order of the harnesses. An (X) in the square represents the heddle through which the thread is inserted.

The design of Fig. 400 is read as follows: 1-2-1-2-1-2-3-2-3-2-3-4, etc., always in the same order of squares.

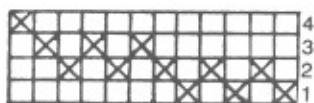

Fig. 400

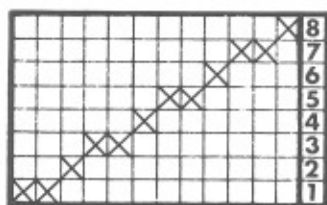

Fig. 401

This drafting can also be used for threading multiple harness looms since it is written in the same way. Just add rows of squares, a fifth row, a sixth row and so on.

XI READING THE PATTERN

The draft indicates the threading of the warp, the manner in which we tie the harnesses to the treadles (the tie-up), and the treadling sequence.

Let us start with the most simple threading which is called the Twill threading or the regular threading.

THE THREADING DRAFT

Each harness is represented by a horizontal space. The harnesses are numbered from one to four, and the one nearest the weaver as he is seated in front of the loom is always number one.

The heddles are shown as crosses in the vertical space. We read the draft from right to left.

The threads are held in order by the cross on the lease sticks.

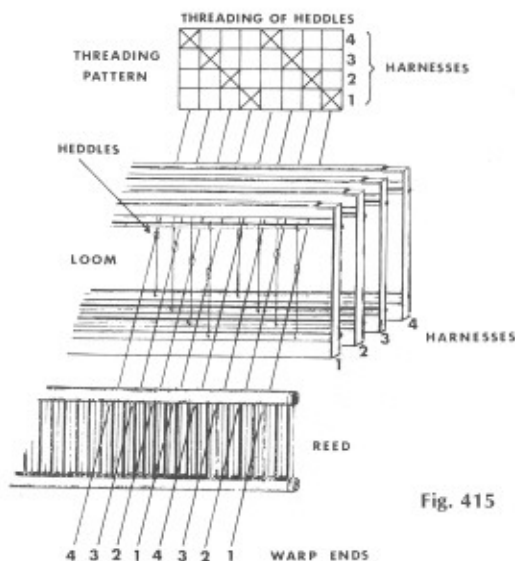

Fig. 415

Pick up as follows:

- 1st warp end, thread through 1st heddle on No. 1 harness
- 2nd warp end, thread through 1st heddle on No. 2 harness
- 3rd warp end, thread through 1st heddle on No. 3 harness
- 4th warp end, thread through 1st heddle on No. 4 harness
- 5th warp end, thread through 2nd heddle on No. 1 harness
- 6th warp end, thread through 2nd heddle on No. 2 harness

Continue in this manner, repeating the basic draft until all the warp ends have been threaded.

With this threading, the warp ends are divided equally between four harnesses.

We raise harness 1, throw the shuttle from the right hand side, beat, then let the first harness go back to its initial position.

Raise harness 2, throw the shuttle back from left hand side, beat, let it go back to its initial position.

Raise harness 3, throw the shuttle from the right hand side, beat, and repeat the same procedure as before.

Now operate harness 4 in the same manner, throwing the shuttle from left to right.

Repeat the same movements, starting with harness 1, then 2, 3 and 4, and continue.

This weaving gives you a single twill.

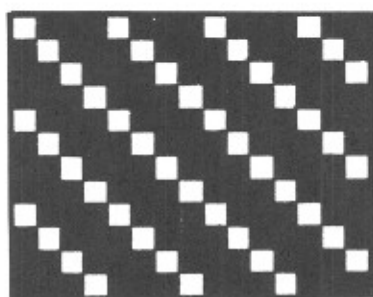

**Right side
Weft effect**

Fig. 417A

Fig. 417B

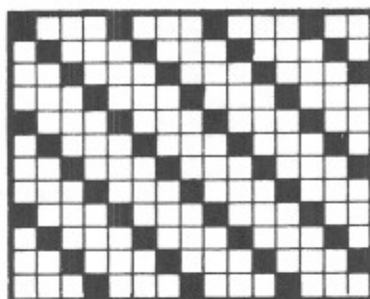

**Reversed side
Warp effect**

As you have only one thread raised out of four threads, this pattern shows mainly the weft thread on top of the material. (Fig. 417A)

If you look at the other side of the material where there is only one thread of the warp covered by the weft, it gives you a warp effect. (fig. 417B)

The harnesses combined with the treadles create the space between the warp threads through which you pass your shuttle. This space is called a "shed". The action of throwing the shuttle through the shed is a "pick" or "shot".

The next three pages will show you the TWILL threading. With it, you can make more than 64 different textures. You will maintain the same threading and tie-up for all of them, merely change the succession of your treadling.

But instead of operating one harness at the time, you will now operate two harnesses at the same time to open the shed.

At this point, we must now investigate the tie-up procedure.

THE TIE-UP DRAFT

The tie-up is the way the harnesses are tied to the treadles. It is generally at the right of the threading draft. One space between horizontal lines indicates a harness. One space between vertical lines indicates a treadle. (fig. 416)

These following examples show you how to make a variety of patterns on your four-harness loom all with the same threading and the same tie-up. **ONLY USE YOUR TREADLES IN A DIFFERENT SERIES TREADLING.**

This tie-up draft indicates that harnesses 1 and 2 are tied to treadle 2. Harnesses 2 and 3 are tied to treadle 3. Harnesses 3 and 4 to treadle 4, and harnesses 1 and 4 to treadle 5.

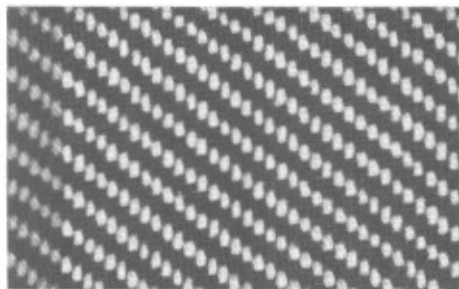

Fig. 418

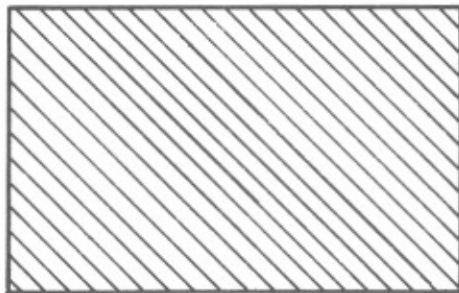

Fig. 418A

The way the treadles are tied up, if you press them regularly as follows: 2-3-4-5-2-3-4-5-2-3-4-5, repeat, you get twill.

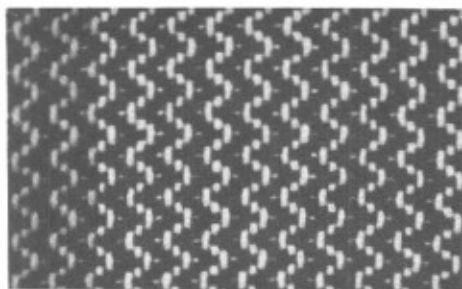

Fig. 419

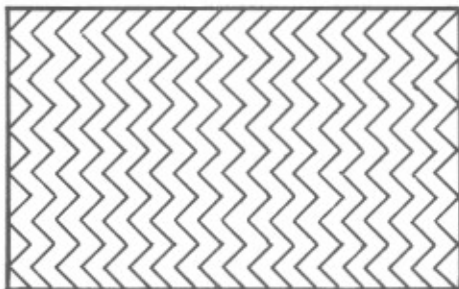

Fig. 419A

If you press them on round trip as follows: 2-3-4-5-4-3-2-3-4-5-4-3-2, repeat, you get broken twill.

THE TREADLING DRAFT

Operating the harnesses in the order indicated by the figures on the tie-up is called treadling.

This diagram shows us in which order to use the treadles. It is always found under the tie-up draft, and is read downward.

If you work on a loom on which the harnesses are operated independently, follow the spots on the tie-up plan to find the harnesses to be used.

Threading				Harnesses				Tie-up				
								Treadles				
								6 5 4 3 2 1				
Thread of 1st shot												Treadling
" 2nd "												
" 3rd "												
" 4th "								4				
" 5th " same as 1st												
" 6th " " 2nd												
" 7th " " 3rd								7				
" 8th " " 4th								8				
" 9th " " 5th												
" 10th " " 6th												
" 11th " " 7th												
" 12th " " 8th								Repeat				
" 13th " " 9th												

Fig. 418B

If you reverse the treadling from right to left and left to right by following the treadling figures, you will get a vertical pointed twill.

Thread of 1st shot												Treadling
" 2nd "												
" 3rd "								3				
" 4th "								4				
" 5th " same as 3rd								5				
" 6th " " 2nd								6				
" 7th " " 1st								7				
" 8th " " 2nd								8				
" 9th " " 3rd								9				
" 10th " " 4th								10				
" 11th " " 3rd								11				
" 12th " " 2nd								12				
" 13th " " 1st								13				

Fig. 419B

Threading Harnesses Tie-up

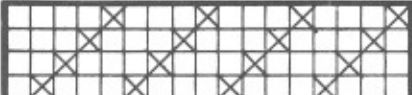
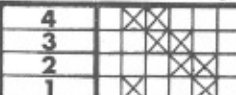
	4	3	2	1	
--	---	---	---	---	--

Saw Dent Twill

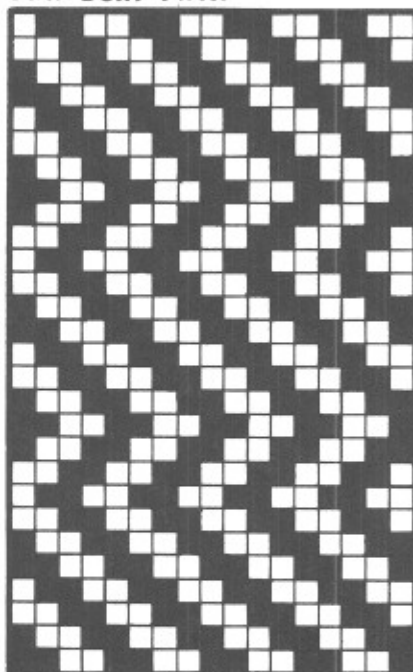

Fig. 420

Treadles

	6	5	4	3	2	1	
1							
2							
3							
4							
5							
6							
7							
8							
9							
10							
11							
12							
13							
14							
15							
16							
17							
18							
19							
20							
21							
22							
23							
24							
25							
26							
27							
28							

Treading

Broken Twill

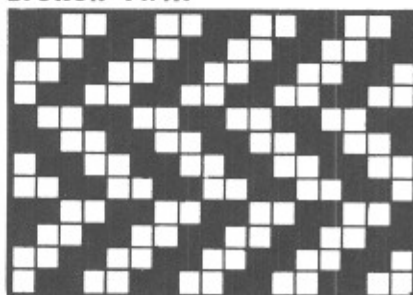

Fig. 421

1			
2			
3			
4			
5			
6			
7			
8			
9			
10			
11			
12			

Vertical Herringbone

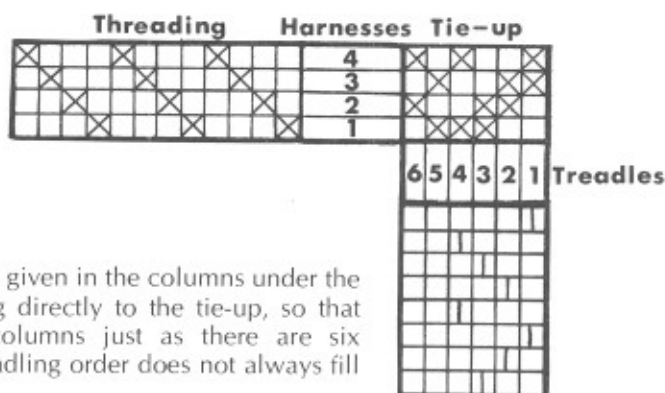

Fig. 422

		1	
2			
	3		
		4	
5			
			6
	7		
8			

Repeat

TREADLING



The treadling order is given in the columns under the tie-up draft, corresponding directly to the tie-up, so that there are six treadling columns just as there are six treadles. However, the treadling order does not always fill the six columns.

The treadling symbols vary because they are subject to each author's choice. Often a vertical stroke is used and is placed in the column corresponding to the treadle.

Sometimes, you find symbols to indicate the treadling. These symbols represent the color of the thread to be passed through the shed.

- ▽ dark blue
- yellow
- tabby

Tabby is often marked only once at the top of the chart. This indicates that a shot of tabby thread is passed through the shed after every row of pattern thread. The tabby treadles are then used alternately.

Treadling directions are greatly simplified by writing the figures in the columns in numerical order, that is for one pattern, then you repeat. The numbers represent the treadling order.

Similarly, space on the draft and the time to fill in the columns are saved by simply writing the treadling draft in a horizontal line, 1-4-3-2-4-1-2-3-1-4-3-2-4 etc. This is the same pattern as the previous one, only that the numbers represent the treadles.

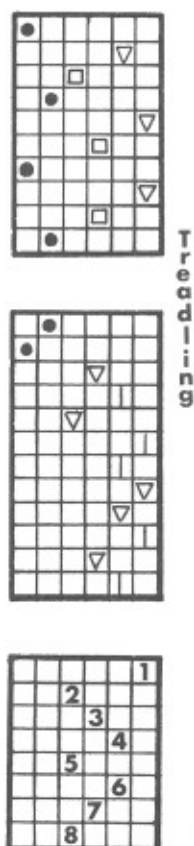

Repeat

Fig. 423

TABBY

When doing a TABBY MATERIAL on a four-harness loom, it is important to use all four harnesses. If only two were used, there would be too many heddles on the same harness. By using twenty-four threads per inch (2,5 cm.) (96 threads per 10 cm.), twelve heddles per inch (48 heddles per 10 cm.) will rise at each treadling. The heddles will be so close that they will wear out the threads by friction. Using inserted eye heddles, the treadling will become almost impossible because the threads will not pass between the heddles of the opposite harness. By using the four harnesses, six heddles per inch (24 heddles per 10 cm.) will rise at each treadling. The threading should be a twill 1-2-3-4, with the tie-up 1-3 and 2-4, treadling alternately. This also applies to 8, 12 or 16-harness looms, except for certain threadings which require crossed threads for a good tabby.

Tabby has another task to fulfil in weaving. It is used to link all the warp threads together when making a loosely woven material or double weave. It is found mainly in Overshot and Summer and Winter weaves where the same treadling is repeated many times. In Overshot, the weft thread of the design is always thrown through the same shed, therefore a tabby is placed between the picks of the design, otherwise the material would not hold together properly.

Tabby is then usually woven with a very fine thread, similar to the warp thread, since it should not be seen as it is not included in the design.

Depending on the method used or the design to be achieved, a tabby shot can be thrown after each design pick, which is usually done, or it can be woven after two, three or even four weft threads; this varies with the crossing of warp threads and weft threads and the length of the floats in the warp.

In Overshot weaves, this book shows how tabby tied up to the two left treadles, that is on treadles 5 and 6. When weaving, the left foot remains on these treadles, sliding from one treadle to the other. The design is woven with the right foot. If the same treadling is used 6 times, the right foot should not be removed so that no time will be lost in finding the treadle to depress it again. Usually, in Colonial Overshot and Summer and Winter, a tabby pick (one shot of tabby from the right hand side, the next shot of tabby from the left hand side) is thrown between the repeated picks of the design in colored thread.

When there are two weft colors, one for each unit, use as tabby the weft color that is in evidence in the next unit, but not the same color as the weft that is presently being woven; the tabby should not appear.

On pattern drafts, in most books, the term "tabby" is used.

DOUBLE FACE WEAVE

This fabric has many possibilities, and to write about all of them would fill a book by itself. Here we shall only give you the simple technique of it.

The material can have two entirely different colors on either side.

It is woven on a four-harness loom and mostly in tabby. Other textures can be made, but it requires great experience on the part of the weaver*.

To acquire a different color on each side you use two shuttles.

This technique can also be used to make stripes of various colors or large squares without tabby nor float.

To understand the technique, here are instructions to make a warm, woolen, reversible blanket or would a reversible cape or coat be more appealing to you?

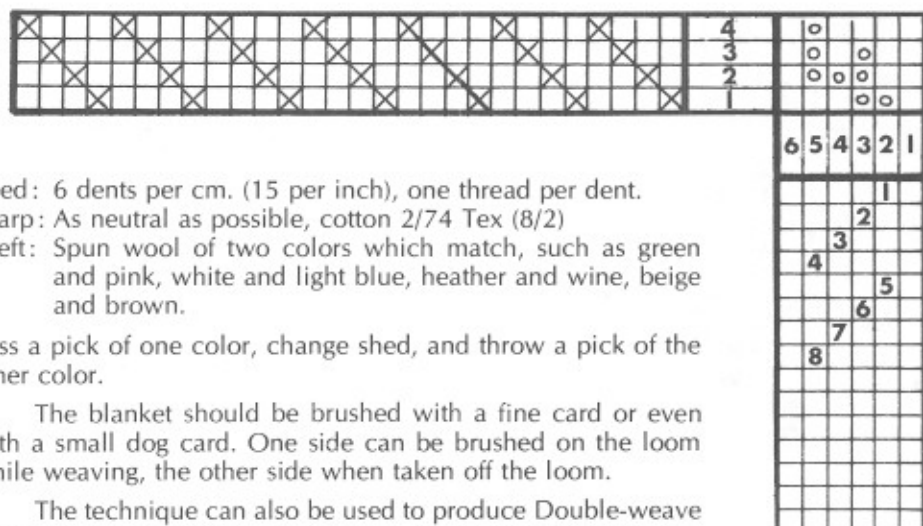

Reed: 6 dents per cm. (15 per inch), one thread per dent.

Warp: As neutral as possible, cotton 2/74 Tex (8/2)

Weft: Spun wool of two colors which match, such as green and pink, white and light blue, heather and wine, beige and brown.

Pass a pick of one color, change shed, and throw a pick of the other color.

The blanket should be brushed with a fine card or even with a small dog card. One side can be brushed on the loom while weaving, the other side when taken off the loom.

The technique can also be used to produce Double-weave for rags with ground-face, decoration, using the pick-up technique, etc.

Fig. 425

* Much more of this technique will be found in «Master Weaver Library». (Volume 15 — Double Weaves) (Expected published in 1981).

CIRCULAR AND SEMI-CIRCULAR WEAVE

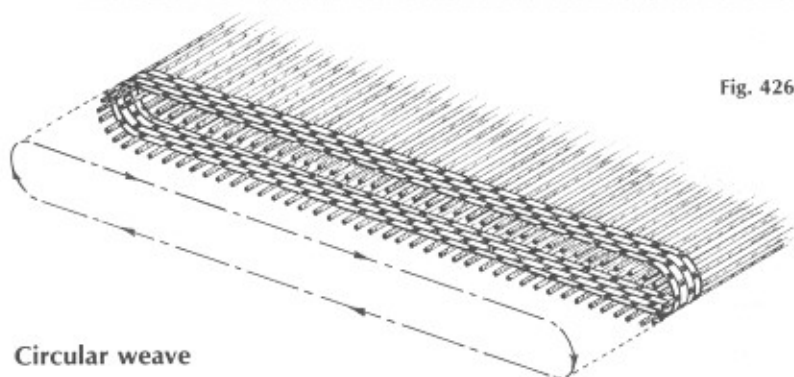
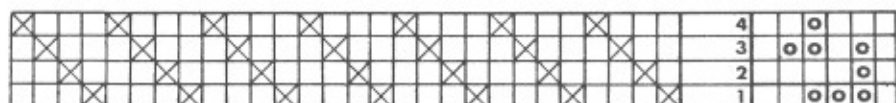

Fig. 426



Circular weave

As we previously explained, two harnesses are sufficient to weave. By using four harnesses, it is possible to make circular weaving using two harnesses, 1 and 3 to make the top part of the material, 2 and 4 for the bottom.

The drawing Fig. 426 shows you what will happen. This material can be used for hand bags, pillow cases, cushions.

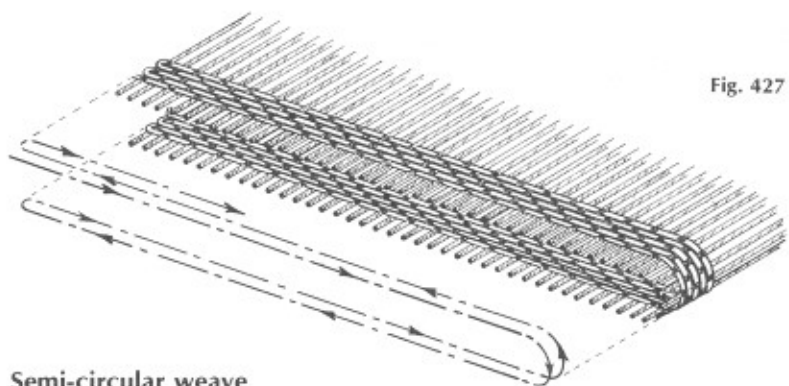
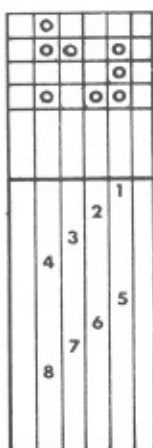

Fig. 427



Semi-circular weave

This technique can also be used to weave material twice as wide as your loom is, such as blankets.

The crease which is formed at the center of the material will disappear after a few washings and pressings.

IMPORTANT: When threading is completed, before starting to weave, remove the first thread at the right of the loom and start weaving from the left hand side of the loom. This method will give you a smoother center for the material.

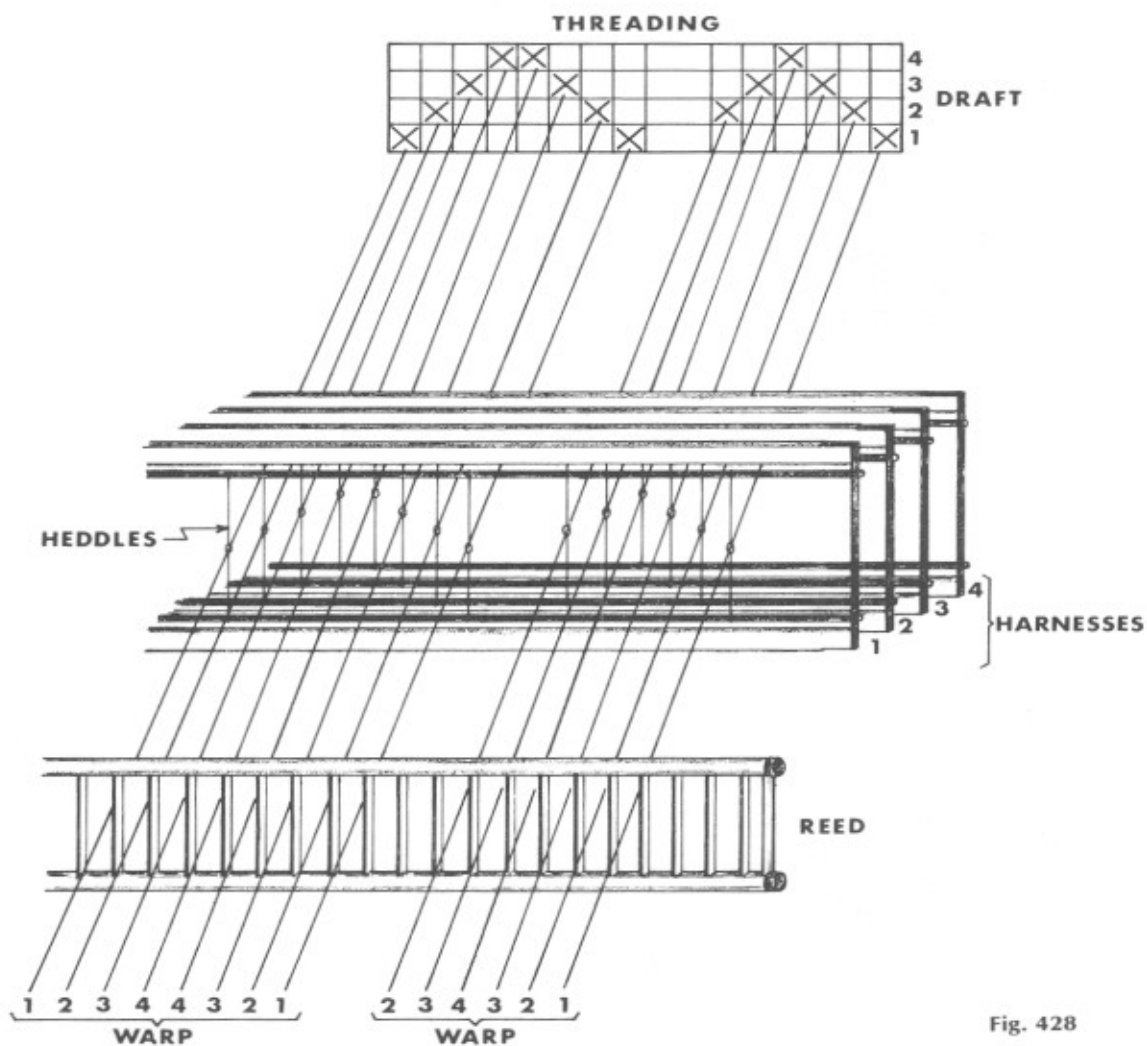

Fig. 428

Change the threading to the "Point and Return" draft which is called Bird's Eye threading (1-2-3-4-3-2-1-2-3-4-3 or 1-2-3-4-4-3-2-1-1-2-3-4-4-3-2-1 and so on.) This threading permits you to make many more patterns as shown here.

BIRD'S EYE THREADING

THREADING										HARNESSES TIE-UP				
										4	o	o		
										3		o	o	
										2			o	o
										1		o		o



Fig. 430

Use 4 treadles
 1. Attach harnesses 2 and 1 to treadle No. 2
 2. Attach harnesses 3 and 2 to treadle No. 3
 3. Attach harnesses 4 and 3 to treadle No. 4
 4. Attach harnesses 4 and 1 to treadle No. 5
 Follow the treading according to the figures and repeat.

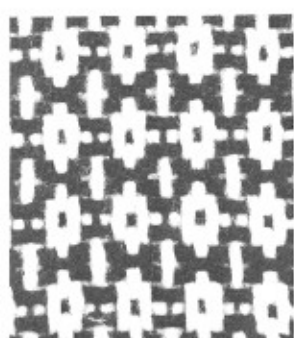

Fig. 431

Use 4 treadles
 Same threading as Fig. 430.
 Same tie-up but follow the treading according with figures.

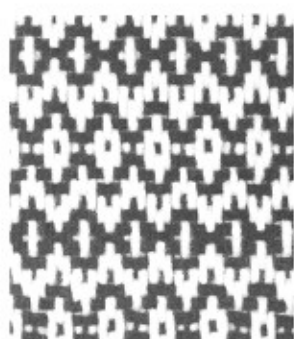

Fig. 432

Use 4 treadles
 Same threading as Fig. 430.
 Same tie-up but follow the treading according with figures.

6	5	4	3	2	1	TREADLES
					1	T
					2	R
					3	E
					4	A
						D
						L
					5	I
					6	N
					7	G
					8	
					1	T
					2	R
					3	E
					4	A
					5	D
					6	L
					7	I
					8	N
					9	G
					10	
					11	
					12	
					1	T
					2	R
					3	E
					4	A
					5	D
					6	L
					7	I
					8	N
					9	G
					10	
					11	
					12	
					13	
					14	

Fig. 429

XII WEAVING

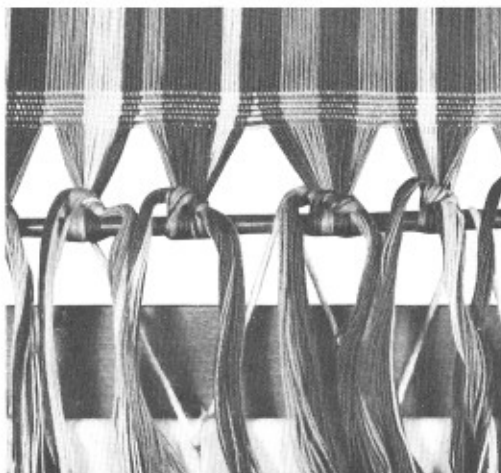

Fig. 455

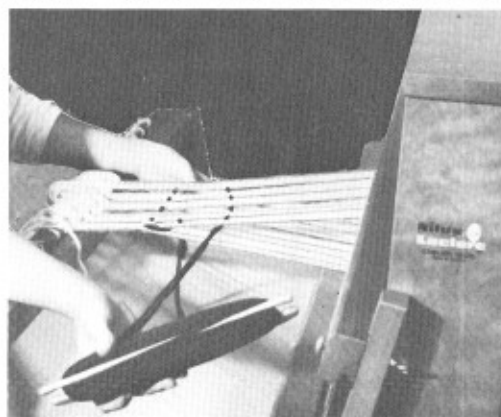

Fig. 456

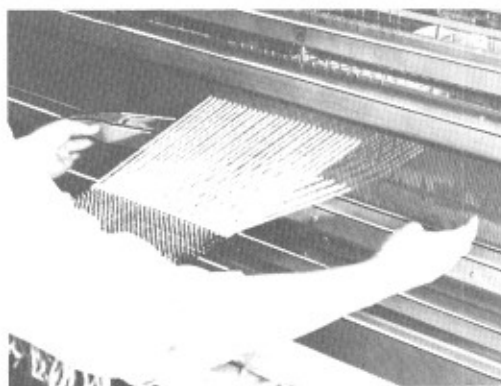

Fig. 457

When starting to weave, we first weave a heading to close the spaces between the groups of threads. Use the tabby treads for weaving the heading. Weave it with plain cotton for about 3 to 5 cm. (1 to 2 in.). To have a more even start, you will do well to place a stick in your shed and then continue for another cm. with cotton. Now start your weaving.

Open a shed by depressing a treadle, and throw the shuttle through the shed. Catch the shuttle on the other side, and with your free hand, grasp the beater in the center, and draw it towards the breast beam to place the weft. Depress the next treadle at the same time as you push the beater back in order to change to shed. Sometimes, on very slippery or sticky warps, it is advisable to change the shed before pushing the beater back, to hold the weft in place, and assure a good shed.

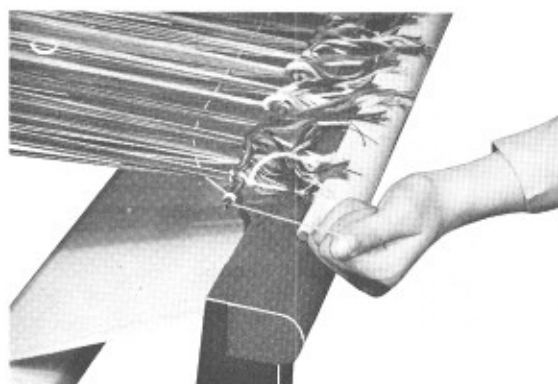

Fig. 458

To prevent the selvedge threads from drawing in too much or curling on the first few shots, you can take a turn around the end of the rod at each end several times.

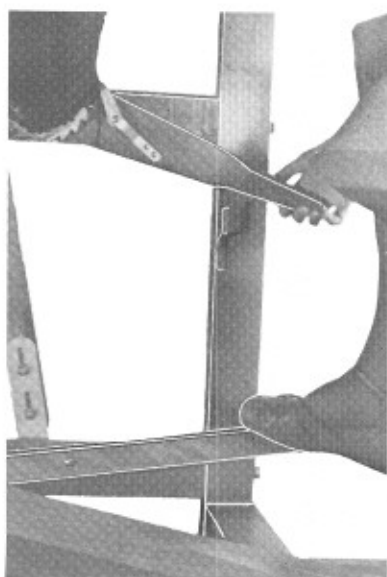

Fig. 459

When you have woven a few centimeters, depress the brake release treadle at the right-hand side of the loom to release the brake on the warp beam. Press the brake just as gently as you would with your car brake. Press it just enough to be able to wind the cloth with the take-up handle onto the cloth beam without releasing the tension on the warp.

Tighten the material firmly with the take-up handle, then press very gently on the brake treadle, just to give the warp a chance to become smooth and return to the same tension as when you started weaving previously.

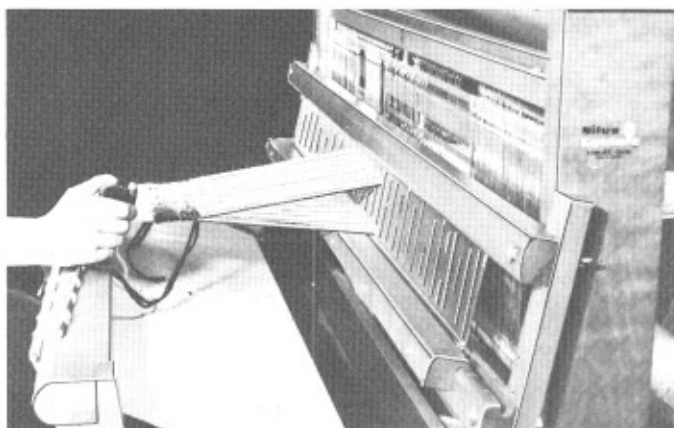

Fig. 460

Do not wind the material too close to the breast beam, to prevent the beater from hitting the breast beam and front posts.

Move your cloth forward frequently. Do not weave more than 5 or 8 cm (2" or 3") before winding web on the cloth beam. This helps to maintain even beating action.

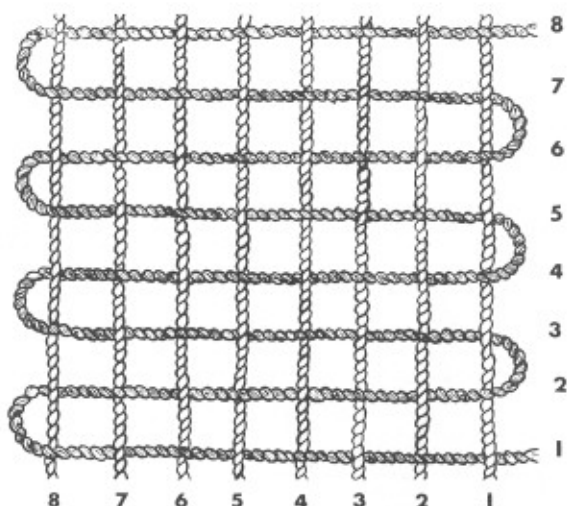

Fig. 461

This illustration shows the crossing of warp and weft in weaving. The warp is all the threads which are beamed on the loom and passed through harnesses and reed. The weft is the thread which is thrown in the shed with the shuttle. The illustration shows that the weft thread turns around the side warp threads making the edge and is continuous but not cut, except when you have to change color by using another shuttle.

To join a weft thread of the same yarn when your spool runs out, see "Joining new weft", page 86 with Fig. 476.

XIII WHAT A WEAVER SHOULD KNOW

The following will save you a lot of headaches and hours of time, as there are many "do's" and "don'ts" of information you need.

Setting-up the loom

This is done in a number of separate processes, each easy in itself, but it requires care and accuracy in its performance. If it seems complicated at first, it is only because there are so many ways to set up a loom or "dressing" a loom.

Check the tension of the warp and the height of the harnesses,
for counter-balanced looms, see on page 14
for jack-type looms, see on page 20

With regard to a folding loom, be sure that the rear of the loom is completely open in order that the distance between the harnesses and the slabstock will be at its maximum to give a good shed. It is an error to try to save space by not opening the loom completely.

When selecting a permanent place for the loom, you must consider: lighting, heating, accessibility.



Fig. 470

A shelf on top of the loom and a holds-all close to the loom are very handy.

The bench

When we sit down at the loom, the elbows at rest should be at the same level as the warp, i.e. the same level as the breast piece. The feet should reach the treadles comfortably. The necessary tools such as shuttles, bobbins, scissors, tape, etc. should be reached easily.

Light

The daylight should come from one side, not from the front or back. The best source of artificial light is an adjustable lamp attached to the loom frame or on a separate stand. Adjust it so that only the part of the loom between the breast piece and the harness is illuminated. Avoid strong light for threading. Direct light from a naked bulb or tube should never reach the eyes of the weaver.

Heating

No radiator, hot-air register, etc. should be anywhere near the loom. It dries the yarn on the warp and damages it. The yarn needs a certain degree of humidity to keep its stretching ability and flexibility. A too dry yarn will unravel and will break easily.

This can also cause sticking in the warp. On a jack-type loom, the harnesses which are not tied, may rise half way when a treadle is pressed to raise other harnesses.

To prevent or correct this problem, use a humidifier to keep the room normally humid or cover warp beam and yarn at the rear of the harnesses with a damp towel.

Another way to correct this problem is to use «Clerco» (Leclerc Cat. No. 61476000). This is an oil, specially made for this purpose, which is applied with a brush on the warp, and does not damage nor soil the warp but prevents it from unraveling.

Do not store the loom in a damp place, reed and heddles may rust, and the wood may warp.

Accessibility

The loom should be accessible from all sides. There should be enough room in the back to put a bench behind it (to sit on when necessary) and as much space as possible in front. Needless to say, the floor must be level or corrected by small rubber pads under the posts.

To produce a good piece of material, the weaver should be sitting comfortably with the stool at the right height to suit the individual.

Cutting off material

If you have to cut your woven material before the end of the warp, you must weave about 1 meter (1 yard) more than the needed piece to be cut. So, you roll this end piece together with the apron. It will hold your warp without having to retie.

CORRECTING ERRORS

Improper slewing

Before starting to weave, check the top of your tabby sheds closely. If you see a place where there is a space wider than the rest, you have skipped a dent. If you see a place with a heavier spot on the warp, you have probably crowded the warp ends there. Crowded or skipped dents will make streaks in your material. There is nothing to do but take out the heading, the lacing cord, and the knots and remove the warp from the reed to the nearest selvedge and to re-sley it. Skipped dents are only permissible for certain types of fabric and then in order.

Crossed-over warp ends

A warp end which does not rise or fall as the treadles are used but remains in the center of the shed in front of the reed has been crossed from the heddle over to the wrong dent. There are two warp ends involved, in fact one crossed over the other. Break them off at the knot, add on a short length of warp to each one, put them through their correct dents, and then tie them around the lacing cord at the knot in any way, just so that the tension is the same as the others.

Misthreading of the draft

Mistakes in threading are more unfortunate but should not be too serious since you have checked your threading carefully as you went along. Sometimes, however, a warp end which should be on harness 3 for instance, is found to be on harness 2. That is two warp ends side by side rise and fall together in the shed when plain weave is treadled, so that the weaving is imperfect.

To repair this, take the warp end out of the wrong harness having first cut it at the knot. Then with a strong cotton or linen or other long thread more than twice as long as your heddles, tie a string heddle on the correct harness, or add a snap-on repair heddle which is made to be placed in any space on the harness. Re-thread the warp end through this repair heddle, re-sley it in the reed, tie on a short bit of warp yarn to make it long enough, and anchor it by winding the thread in a figure eight around a pin.

To tie a string heddle, first make what is called a doup by centering a piece of heddle cord under the bar of the harness where the string heddle is to be tied. Tie a square knot with the two ends so that the knot comes in line with the lower part of all the eyes of the other heddles. Tie another square knot above this one on a level with the top of all the eyes of the heddles, thus making an eye in the string heddle. Then tie ends on top of the heddle bar at the upper part.

Omission of threading

Suppose that you find that you have completely left out one thread of the draft. This causes a flat in your tabby. On a spool or on one of the bobbins which fits into your shuttle, wind on sufficient thread and use this to take the place of the warp end which was omitted. Put in a repair heddle or use a string heddle on the

correct harness. Now you will have to re-sley the warp through the reed to the nearest selvedge to accommodate this extra warp end which is anchored in front with a pin. (Fig. 471)

In addition, you will need to add weights (metal washers or anything that gives the correct weight will do) to the bobbin hanging down over the slabstock until you have it at the same tension as the others. This can be ascertained once you begin to weave, if the warp end looks puckered in the cloth, it is not weighted enough to be tightly drawn and it needs more weight. Weighted warp ends hanging down behind the slabstock may look untidy, but they work and that is the main thing.

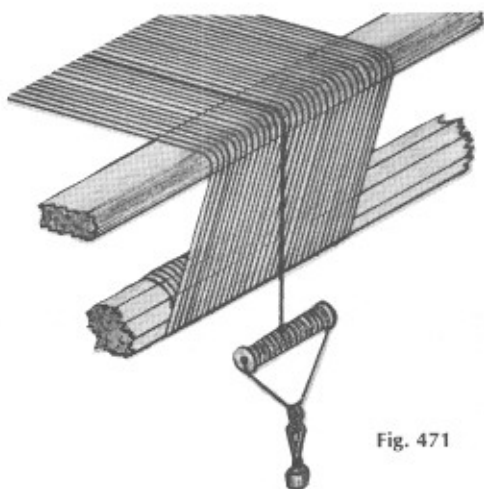

Fig. 471

Broken warp ends

Warp ends do break now and then. Measure off a length of warp long enough to reach from the slabstock to the breast beam, with a little extra for tying, take the new end through the eye of the heddle, through the reed, anchor with a pin in a figure eight, pull the broken end back out of the reed and heddle eye, weave an inch or so, take yarn off the pin and darn the new end in, clip ends. Doing this on the loom saves a great deal of time later when your web comes off the loom.

Never leave a pin in the web and wind it on the cloth beam as it may ruin a fine piece of weaving. Naturally the other ends of your new warp end will hang over the edge of the back beam, and be weighted as discussed before. The other ends on the warp beam will be brought forward when it is long enough and handles as a new end.

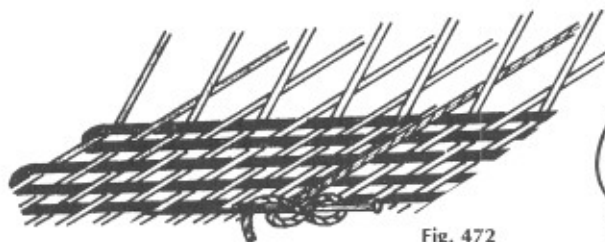

Fig. 472

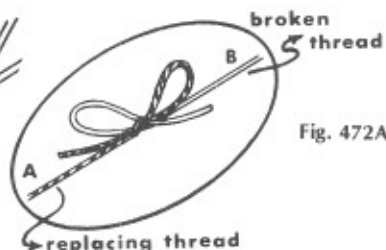

Fig. 472A

GOOD SELVEDGES

Avoiding draw-in

To prevent the material you are weaving from narrowing or drawing in at the selvedges, the weft should be placed in the shed at an angle and left loose in the shed just before beating it. If this is not done, the strain of drawing in becomes so great that the selvedge weft in the shed is crimped by the interweaving which takes place between warp and weft and which shortens the latter, causing the material to become narrower than the width of the warp in the reed. No amount of fussing or pulling at the selvedges will cause them to become wider once they are drawn in, so form the habit of placing the weft in the shed at an angle and do not pull on the weft with the hand that holds the shuttle. Some draw-in is bound to occur, but strive to keep it down to a minimum.

The beater must be grasped in the center because if not, your rows of weft will not lie parallel to the breast beam but will climb uphill at one side or the other.

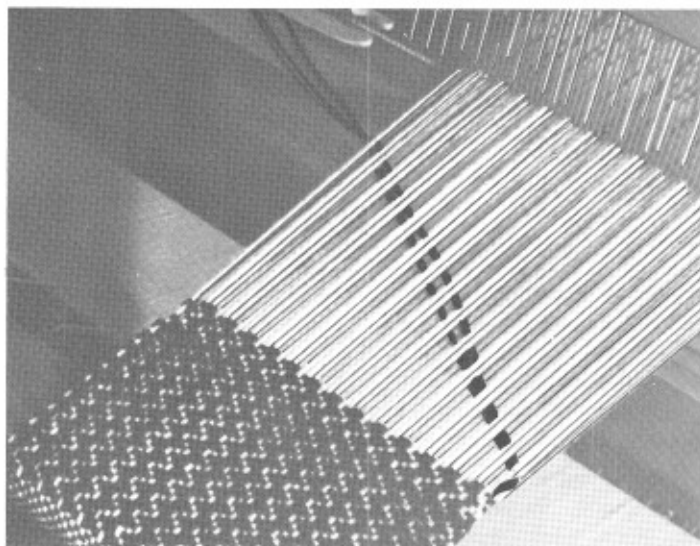

Fig. 473

Selvedges are most important when you are entering a piece of weaving in a competition. They should also be neat for articles such as stoles, scarves, ponchos, place mats, napkins, etc.

In mixed wefts, often used in place mats, the not so perfect selvedge is not too noticeable.

In yardage for clothing or drapes, they should be cut off, as they are set closer and will shrink at a different tension.

It is with practice that you will improve the selvedge. At first it will be uneven, full of loops, too tight, but with good care it will improve gradually.

What went wrong?

Tabby weaving is the test of a good weaver and should never be given to a beginner. It is really the test of a master in hand weaving. One has to watch for streaks, which will show that it was not beaten evenly, or the tension at the dog and ratchet so that it feels the same every time you move the warp forward. If there are loops left by the weft at the selvedge (Fig. 474), you are not pulling enough on the weft, or perhaps you have placed the shot in the shed at too much of an angle.

If you are drawing in too much, and cutting your edged ends it is wiser to waste any length or warp by beaming forward, starting again, and making sure you are laying your weft in on the angle.

Should your weft persist in running uphill at the selvages, you may have tied the outside bouts of your warp too loosely to the apron stick in front. Should they turn down, then the outside ends may have been tied too tightly to the front apron stick.

The poor selvedge



Fig. 474

The perfect selvedge



Fig. 475

Take notes

When you take up weaving, you never realize how far you will go in this craft, and when you do it, it is too late to recapture memories. But better late than never.

JOINING THE NEW WEFT

When the weft in the shuttle runs out, never tie on the new end to the old. Simply keep the shed open in which you were weaving. Insert the shuttle with its fresh bobbin through the shed in the same direction in which you were going. Then allow the end of the weft coming from your shuttle to overlap the old end in the shed for a short distance. One to two cm. (1/4" to 1/2") is plenty for most wefts, unless the warp ends are sleyed far apart. Bring the two ends up through the warp on top of the shed and let them stick up there. Continue to weave for 3 cm. (1 inch) or so. Then cut the ends off close to the surface of the weaving. They will hold. This should be done near either one of the edges even at the cost of a few cm. of weft. The reason being that when articles are judged, a shadow caused by double threads will cost you points. It cannot be seen at the edge for reasons stated before.

Very heavy wefts should be frayed out at the ends so that where they overlap at the joint they are not too bulky. When starting to weave with a heavy rug filler for instance, separate the end coming into its separate strands for about 10 cm. (4 in.), eliminate one of these strands by pulling it until it frays off. When the remaining strands are run back into the shed, the resulting overlapping should not be too noticeable. Never leave all these ends dangling in your weaving. Clip them off.

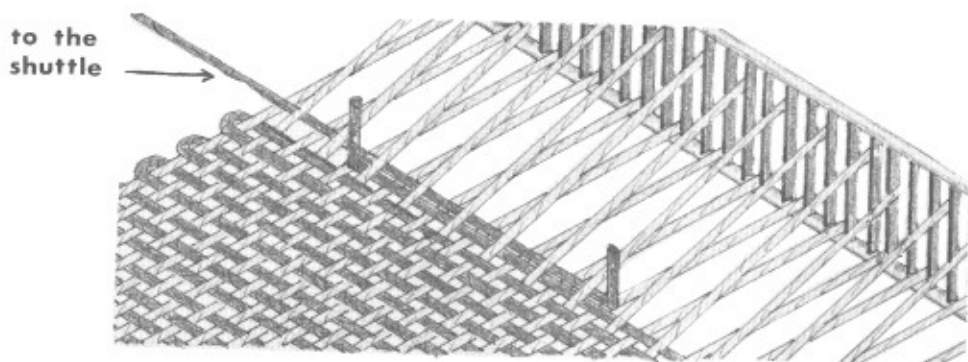

Fig. 476

Rules of the day

When you leave your weaving for the day, it is a good habit to ease the tension on your warp just a little. Warp ends can snap in a change of temperature, cottons tighten up considerably and it has been known for several warp ends to snap during the night.

It goes without saying that you insist that nothing be placed on the warp of your loom. People are usually drawn to that nice even spread of threads to lay books, coats, hats, etc. A warp bagging and sagging in spots is very bad indeed, and in some cases may need re-beaming. Cover your loom for the night or when not in use with plastic or other material.

XIV FRICTION BRAKE

The friction brake permits a fine adjustment of the warp tension. (The ratchet wheels and dogs give a more or less uniform tension, depending on the correspondance of the teeth on the wheels and the diameter of the beam.)

The friction brake is particularly appreciated on fine material, on fibers without elasticity as linen and fine wool.

It has a flat steel wire band, called a wire brake circle, wound several times around a metal friction wheel, which is attached to the end of the warp beam. One end of the wire circle is attached directly to the loom. The other end is attached to a coil spring which pulls it straight down. The greater the pulling power applied to the wire brake circle the stronger the brake action.

IMPORTANT: When putting the brake circle on the friction wheel do not attempt to uncoil it or disturb it's natural coil in any way. If uncoiled or bent the brake will not operate properly and the wire circle must be removed from the loom. When removed from the loom, one can attempt to recoil it by winding it on a round object of a smaller diameter than the friction wheel.

To install or remove the warp beam from the loom, insert or extract the friction wheel from the wire brake circle. (fig. 486)

It is also important to check the wire brake circle to insure that none of the coils overlap each other and that they are all in their proper place on the friction wheel. These items are critical to the proper operation of the brake.

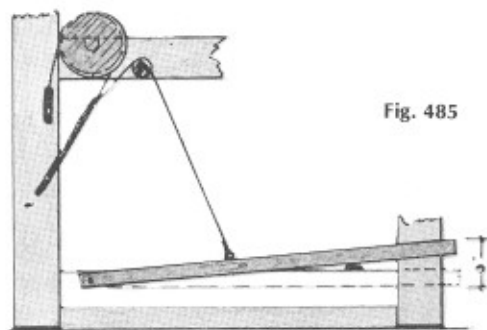

Fig. 485

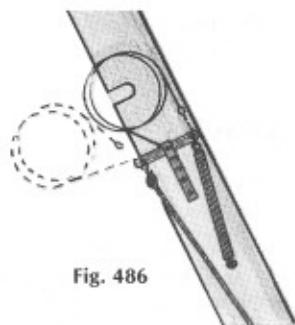

Fig. 486

The beam must turn clock-wise to roll the warp.

On older looms or on those which have had excessive use, you may find that the brake does not hold properly. This is usually caused by dirt, lint, or grease on the wire circle and friction wheel. The metal parts should be cleaned with a cleaning solvent. If the brake still does not hold properly, check the friction wheel as it may have worn very smooth. In this instance, use a small flat file to score or rough the surface of the friction wheel to allow the wire circle to grip.

Depending on the style of loom you have, the brake system may be released as follows:

— By depressing the brake, release lever. It can be held in down released position by a small catch installed for this purpose on the front of the loom.

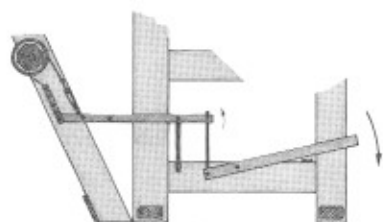

Fig. 487



Fig. 489

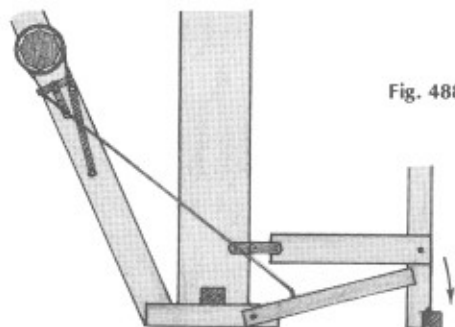

Fig. 488

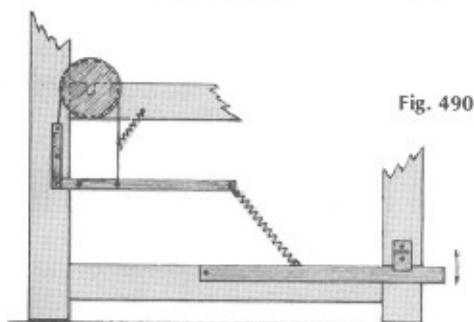

Fig. 490

- By releasing the brake release lever from its mechanical stop and allowing the brake lever to raise.

WARNING: Never put grease, oil or any type of lubricant on the brake system, as it will cause it to slip.

Weaving

- If your loom is equipped with the friction brake as illustrated in figures 485, 487, 488 or 489, to advance the warp:

Press the brake release lever with very gentle and steady pressure as you would apply the brake on an automobile. Rotate the cloth beam at the same time. Allow the brake to lock in place by taking your foot off the lever. Continue rotating the cloth beam to the next notch in the ratchet wheel. If the tension is too great, apply very slight, gentle pressure of the foot brake release until the desired tension is reached.

- If your loom is equipped with friction brake as illustrated on figure 490, to advance the warp:

Release the brake treadle very gently, controlling it with your foot to keep enough tension to prevent the warp from unrolling too fast, rotate the cloth beam at the same time. Depress the brake release lever and lock the brake in place. Continue to rotate the cloth beam to the next notch in the ratchet gear. If the tension is too great, very gently release it by a slight pumping action on the brake release lever until the proper tension is reached. Lock the brake lever in down position.

XV DOUBLE WARP BEAM

There are some warps where maintaining an even tension presents a problem, and it is necessary to divide the warp. We give a few examples and suggestions.

First: Warps with both fine and heavy threads, often used in drapes and upholstery, can be successfully combined on one warp beam, provided no more than two or three fine threads are between the heavy threads. Warp sticks should be used every 10 cm. (4") as the warp is beamed to keep the warp layers well separated and prevent uneven build-up of heavy and light warp threads.

Second: If your draft produces repeated warp floats on the same warp ends; while the other ends always interweave, the take-up on the floating ends will not be the same as on the interwoven ends. This can be corrected by opening the shed that raises the floating warp ends and inserting a rod under these ends behind the harnesses. Slide the rod back until it is under the warp beam and suspend weights from it until these threads are under the same tension as the rest of the warp. (Figs. 495 and 496)

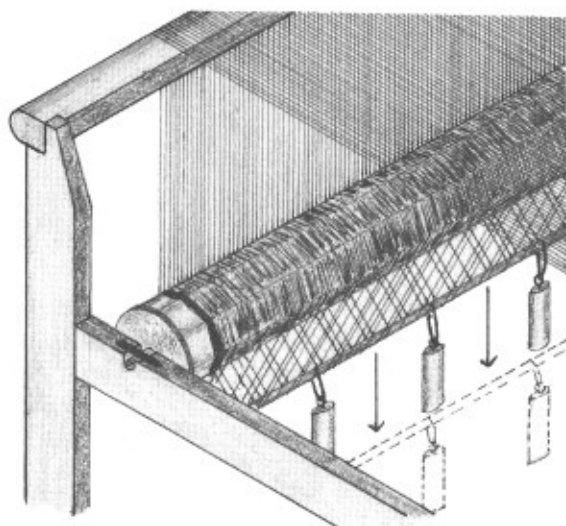

Fig. 495

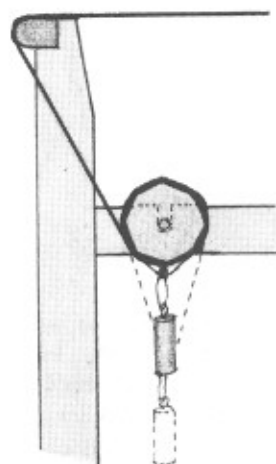

Fig. 496

Third: When mixing threads of different elasticities, such as wool or cotton with linen or silk, the more elastic threads will stretch more under the tension and you will have a poor shed. The solution is the same as in the second example.

On a long warp, these solutions to even tension are not sufficient or satisfactory, and we would recommend an extra warp beam*. The warps should be made separately.

An extra warp beam is useful with several techniques, and a necessity for supplementary warp patterning, and for articles requiring warp loops.

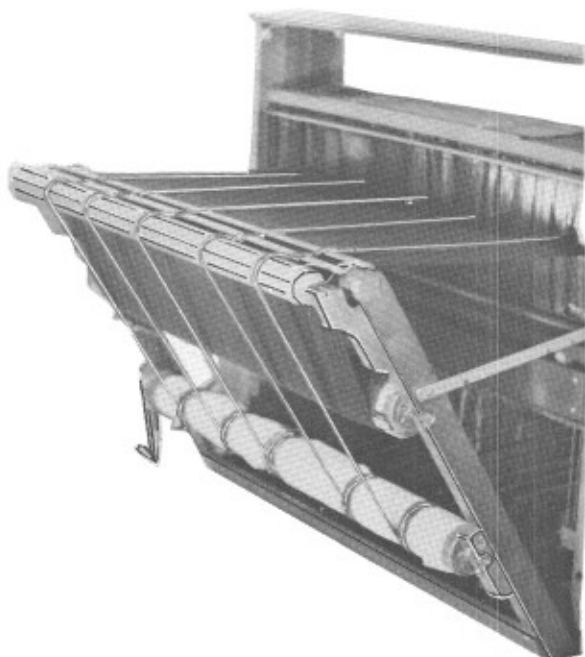

Fig. 497

Install the second beam lower than the regular one at a reasonable distance to be able to put a long warp on each beam, or one sectional warp beam. Follow the instructions supplied with the second warp beam.

A second breast beam has to be attached at the rear of the loom, at about 15 mm. (1/2") higher than the regular breast beam and towards the outside of the loom to allow heavy threads to pass freely between both (minimum 2 cm. (3/4") (Fig. 497)

It is necessary to have both warps entirely separated up to the harnesses and to have different tensions in the techniques where a warp must be released more frequently than the other. The warp which should be released more frequently should be on the second warp beam.

* Much more of this technique will be found in "Master Weaver Library" — Volume 5.

FLYING SHUTTLE

The **flying shuttle beater** is only recommended for weaving material wider than a person can easily reach, that is if you can not throw the shuttle and catch in on the other side. The maximum of a throw usually lies between 90 to 120 cm. (36" to 45"). On a narrow material, the flying shuttle is not faster than the hand shuttle.

The shuttle: It should have metal tips on both ends to preserve the tips. The yarn should leave from one end of the shuttle from a quill which is well filled up.

The best results would be obtained if there was a special designed shuttle for every yarn. But since this is quite impossible for the numerous yarns, we are trying to adjust our shuttles to the most used yarns (wool, cotton and man-made fibers).

The quill should be filled cone-like (see fig. 205, page 11) with the thread running off at one end. This enables the thread to run without resistance. If the smooth run of the thread is blocked, the shuttle might have been thrown out of its trajectory and then out of the loom. A light resistance of the unwinding of the thread may also cause the edge of the material to pull in, while a too loose flow will leave loops on the selvedge.

If the quill empties too fast, especially by linen, silk or nylon, glue a piece of fur at the inside of the shuttle, toward the outgoing end (short haired fur, even artificial fur will do). How far you line the shuttle depends on how slippery your weft thread is. Most shuttles have the possibility of an adjustment, which enables you to give more or less tension according to your thread. The holes in the shuttle, through which the thread runs can be blocked partly with a heavy woolen thread or a fine piece of material to press a little against the running weft thread.

There is no general rule for the adjusting. It depends on the yarn used and the humidity of the room.

OPERATION

The weaver always holds the handle with the same hand, the other hand is on the middle of the beater.

The movement of throwing the shuttle is made either by the wrist turning the handle, or by moving the handle from left to right, or right to left, depending in which side the shuttle is.

It takes practice to get used to this type of weaving. You have to control the rhythm of your movements, to cooperate the throwing of the shuttle, the beating and the changing of the shed.

To change the shuttle for an other color, pull the beater in front, don't open the shed, pull your shuttle smoothly over the material in front of you and let it rest there. Push the new shuttle into the shuttle box.

XVI UNDERSTANDING WEAVING

The following two projects, when completed, will give you a selection of samples and will help you to understand how to design different projects. It will further teach you how to easily modify the texture, even with the same threading, by changing colors.

First project

For the first project we recommend a cotton warp, as it is durable, easily workable and inexpensive. We suggest the weaving of place mats, using them as an exercise to understand weaving at its best. The instructions are given in both the English and metric systems. We shall make the warp long enough to allow for a practice section, followed by four place mats. Following the instructions, select either the metric or English warping procedure. Do not mix them. Use light and strong colored thread.

Warping metric system

You will need:

For the warp: 2/74 Tex, 100 gr. light and 100 gr. dark

For the weft: Same color as the warp

Piece for exercise: 1 meter 1 meter

4 place mats at 50 cm. each: 2 meters 2 meters

3 meters

Loss at the beginning to tie on the loom: 20 cm. 20 cm

Loss at the end to tie on the loom: 50 cm. 50 cm

6% take-up of warp while weaving: 18 cm. 18 cm

(6% of 300 cm.) 88 cm

3.88 meters (app. 4 m.)

Width in reed: 34 cm

Reed: 5 dents per cm., 2 threads per dent

Threads X Dents X Cm width = Ends of warp

2 X 5 X 34 = 340

340 threads of 4 m. long = 1400 m. of cotton

Tex N 2/74 cotton is 6757 m. per kg. (See page 105)

6757 m. = 1000 gr.

1400 m. = $\frac{1000 \times 1400}{6757} = 207$ (makes 208 grams of cotton)

208 grams for 340 ends of your warp is needed.

Warping English system

You will need:

For the warp: 8/2 cotton, 1/4 lb. light and 1/4 lb. dark

For the weft: Same color as the warp

Piece for exercise: 40 inches 40"

4 place mats at 20" each: 80 inches 80"

120" or 3 1/3 yards

Loss at the beginning to tie on loom: 8 inches 8"

Loss at the end to tie on loom: 20 inches 20"

6% take-up of warp while weaving: 7 inches 7"

(6% of 120") 35"

155" (app. 4 1/3 yards)

Width in reed: 14" + 4 threads

Reed: 12 dents per inch, 2 threads per dent

Threads X Dents X Inches width + 4 threads = Ends of warp

$$2 \times 12 \times 14 + 4 = 340$$

340 threads of 4 1/3 yards long = 1473 yards of cotton

English count 8/2 cotton is 3360 yards per pound. (See table page 105)

3360 yards = 1 lb.

$$1473 \text{ yards} = \frac{1 \text{ lb.} \times 1473}{3360} = \frac{1473}{3360} = \text{App. } 1/2 \text{ lb.}$$

1/2 lb. for 340 ends of your warp is needed.

Warping direction

We assume you use the warping frame.

Take a string the length of your warp which is 4 m. (4 1/3 yards) and place it on the warping frame, using the cross pegs on top and bottom of the frame.

Take four bobbins of cotton of your chosen color: 2 light (grey) and 2 dark (red).

Parts 1 and 2: Use 4 threads (2 dark, 2 light). Make 30 single times or 15 round trips.

$$\begin{array}{r} 4 \text{ threads warped at the same time} \\ \times 2 \text{ bunches of 4 threads per crossing} \\ \hline \end{array}$$

8 threads per crossing

$$\begin{array}{r} \times 15 \text{ crossings} \\ \hline \end{array}$$

120 threads

Part 3: Use 2 threads of a same color, leaving the two others of the other color free on the last peg. Make one round trip with light threads and one round trip with dark threads. Repeat this 12 times. Then, make one round trip with light threads.

$$\begin{array}{r}
 12 \text{ times} \\
 \underline{\times 2 \text{ runs at each time}} \\
 24 \text{ runs for light thread} \\
 + 24 \text{ runs for dark thread (same as for light thread)} \\
 \hline
 48 \text{ runs} \\
 \underline{\times 2 \text{ threads per run}} \\
 96 \text{ threads} \\
 + 4 \text{ last light threads} \\
 \hline
 100 \text{ threads at the centre}
 \end{array}$$

Then, repeat parts 1 and 2 for the other border with four threads that gives 120 threads.

$$\begin{array}{r}
 \text{Total: Parts 1 and 2} = 120 \text{ ends} \\
 \text{Part 3} = 100 \text{ ends} \\
 \text{Parts 4 and 5} = \underline{120 \text{ ends}} \\
 340 \text{ ends}
 \end{array}$$

Now beam and thread your loom by following the instructions starting on page 44.

Warp: X = Dark thread
 ● = Light thread

Weave about 10 cm (4") of each treadling, always finishing your pattern. After finishing all your samples, place a cardboard of 3 cm (1 1/4") in your shed; this will provide the unwoven warp ends for your place mat fringe.

Weaving direction

To make these designs, use two shuttles (one with the light thread and another with dark thread). Start by the right hand side.

Follow numbers of shuts of each color, according to the pattern given with treadling.

For each change of color, cross the two shuttles to keep the two threads on the border. This requires attention on beginning but becomes soon a habit.

* When the warp thread on the border is not taken by the weft, leave it free for the time of weaving. When weaving is finished, cut it and enter the ends on the edge.

Treading

Use treadles

A (Tabby)	5 - 6	Use dark shuttle only.
B (Tabby)	5 - 6	Use light shuttle only.
C (Tabby)	5 - 6	Follow the order of color as in the 1st part of the threading by alternating your two shuttles.
D (Tabby)	5 - 6	Follow the order of color as in the 2nd part of the threading, that is two light threads and two dark threads.
E (Tabby)	5 - 6	Follow the order of color as in the 3rd part of the threading, that is four light threads and four dark threads.
F	1 - 3	Basket weave with one dark thread followed by a light thread on same shed.
G	1 - 3	Basket weave with two dark threads on same shed, and two light threads on next shed.
** Note when using harnesses Nos 1 and 2 together (treadle 1) or harnesses 3 and 4 together (treadle 3), the warp is always 2 threads together.		
H	1 - 2 - 3 - 4	Follow the order of color as in the 2nd part of the threading, that is two light threads and two dark threads.
I	1 - 2 - 3 - 4	Follow the order of color as in the 3rd part of the threading, that is four light threads and four dark threads.

The place mats

Select your favorite sample(s) and design it (them) into a place mat of 44 cm. (17 1/4"). Then, use the 6 cm (2 1/2") cardboard for your fringe and start the second place mat. When you have finished the four place mats, cut the 6 cm (2 1/2") warp exactly in the middle. So you get a 3 cm (1 1/4") fringe on each side. Place a stitching with a sewing machine or by hand at the first and last pick of each place mat to have it securely finished.

The place mat piece (as illustrated on page 101) has been made as follows: 6 cm (2 1/2") as sample A (tabby and log cabin), 33 cm (13") as sample C and 6 cm (2 1/2") as sample A (tabby and log cabin).

Note: This weaving is a balanced count, which means the same number of weft threads as warp threads per cm. or inch, which is 24 x 24 per inch or 10 X 10 per cm. This has to be taken into consideration when beating.

First project

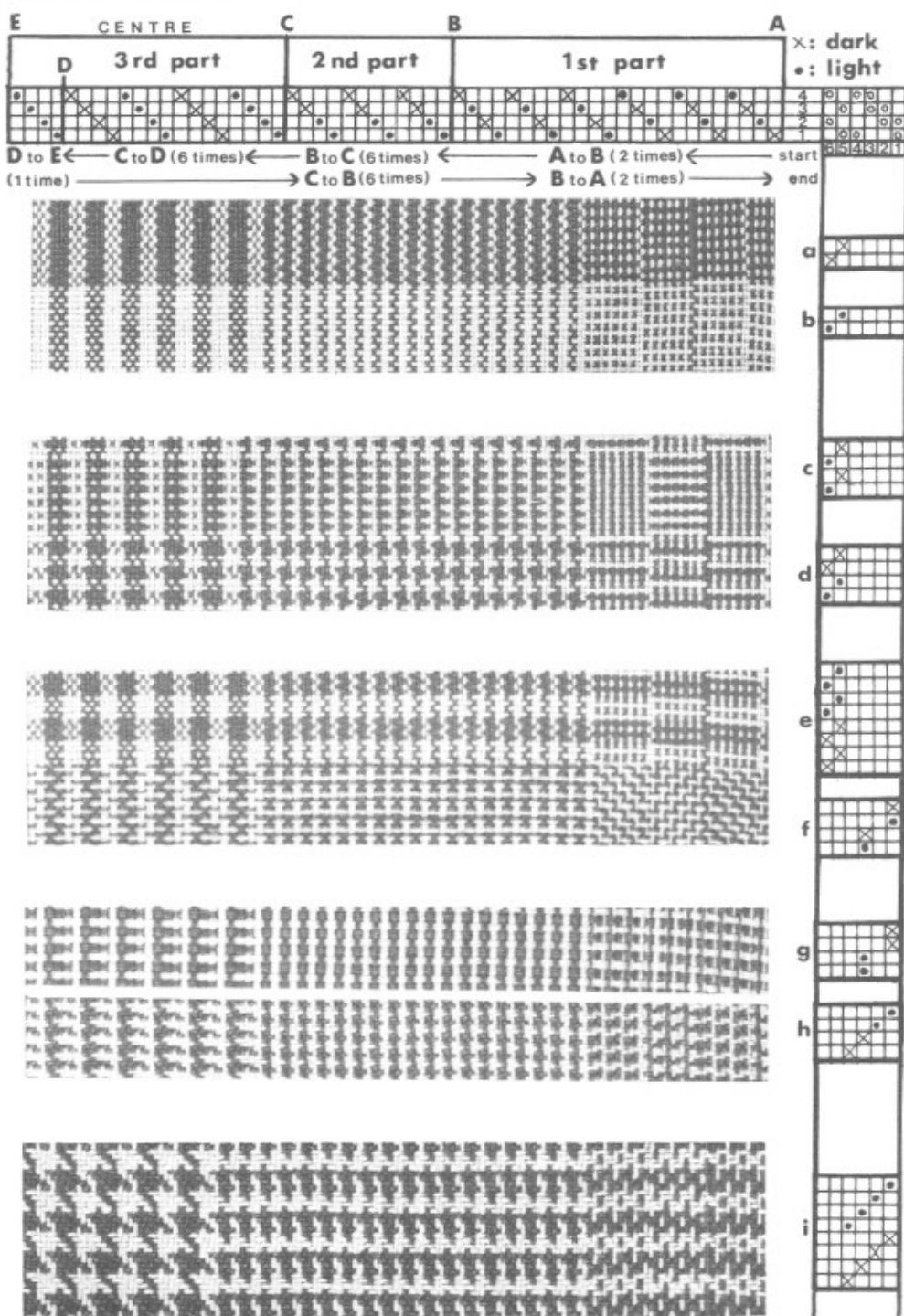

Second project

× :dark
• :light

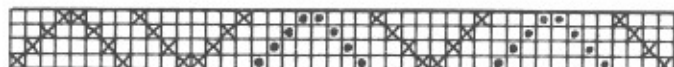

Centre - 88 threads
Repeat $5\frac{1}{2}$ times

← Right side border - 28 threads ←
→ Left side border - 28 threads →

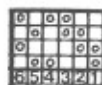

A

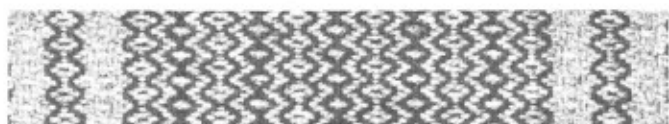
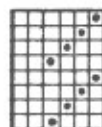

B

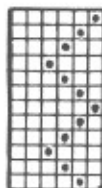

C

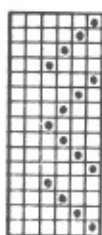

D

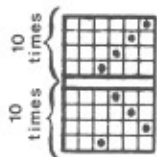

E

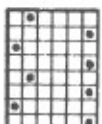

F

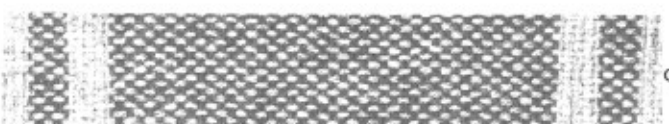
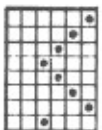

G

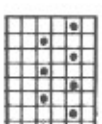

Fig. 506

Second project

On the first project, the threading has been made in a simple way: "twill threading". For this one, we will use "chevron threading". You can compare the difference in design which is made when using the same treadling. We shall make a woolen scarf using two-ply wool of a medium size 12/2 either weaving or knitting wool.

Use the same warping frame as on the first project, with two bobbins of each color you choose. The sample has been made with red wool represented by X and light grey represented by ●.

Warping metric system

You will need:

For the warp and weft: Wool of medium size (2/74 Tex)
100 gr. light color
100 gr. dark color

Warp for exercise: 40 cm.	40 cm.
One scarf: 52 cm.	52 cm.
Fringe (1st end): 13 cm.	13 cm.
Fringe (last end) from loss on heddles	
	<hr/>
	105 cm.

Loss at the beginning to tie on the loom: 20 cm.	20 cm.
Loss at the end to tie on loom (take the fringe of one of scarf on this loss): 51 cm	51 cm.
Take-up of warp while weaving: 6 cm. (6% of 105 cm.)	6 cm.
	<hr/>
	182 cm (app. 1,82 m.)

Reed: 5 dents per cm. 1 thread per dent
Width in reed: 31 cm.
Thread × Dents × Cm Width = Ends of warp
1 × 5 × 31 = 155
Put pegs to get 1,82 meter or slightly more.

Warping English system

You will need:

For the warp and weft: Wool of medium size (12/2)
1/4 lb. light color
1/4 lb. dark color

Warp for exercise: 55"	55"
One scarf: 60"	60"
Fringe (1st end): 5"	5"
Fringe (last end): from loss on heddles	
	<hr/>
	120"

Loss at the beginning to tie on the loom: 8"	8"
Loss at the end to tie on loom (take the fringe of one end of scarf on this loss): 20"	20"
Take-up of warp while weaving (6% of 120"): 7"	7"
	<hr/>
	155" (app. 4 1/3 yards)

Reed: 12 dents per inch, 1 thread per dent
 Width in reed: 12"
 Thread \times Dents \times Width = Ends of warp
 1 \times 12 \times 12" = 144
 Put pegs to get 4 1/3 yards or slightly more.

Warping direction

Follow draft on page 97

Right border: 4 threads dark X (red)
 8 threads light ● (light grey)
 8 threads dark X (red)
 8 threads light ● (light grey)

Center: 88 threads dark X (red)

Left border: 8 threads light ● (light grey)
 8 threads dark X (red)
 8 threads light ● (light grey)
 4 threads dark X (red)

Warp with two threads.

- 1st: 2 dark threads one round trip. Make crossing at both ends. Stop the ends by turning them around a peg which is not used on your warping board.
- 2nd: 2 light threads. Make two complete ways. Take your dark threads off the peg and turn your light threads on it. This prevents the cutting of the ends.
- 3rd: 2 dark threads. Repeat same as second.
- 4th: 2 light threads. Repeat same as second.
- 5th: 2 dark threads. Make 22 complete turns on the warping board.
- 6th: Same as 4 th.
- 7th: Same as 3rd.
- 8th: Same as 2nd
- 9th: Same as 1st.

Now, tie the cross both ends and beam and thread your loom by following the instructions starting on page 44.

Weaving

Use one shuttle with light thread same as warp. For each sample, weave approximately 15 cm (6").

- A) Weave with treadling A. Place a stick to divide.
- B) Weave with treadling B. Take off the divider stick and use it again to divide.
- C) Weave with treadling C.
- D) Weave with treadling 1-2-3-4 (10 times) and then, 3-2-1-4 (10 times).
- E) Weave with treadling E.
- F) Weave with treadling F.
- G) Weave with treadling G.

ATTENTION

On treadling A and D, one warp thread will not be woven on selvage right or left. When the weaving is finished, cut this thread and enter the end in the weaving.

Scarf

Now, choose which pattern you prefer and make the scarf using for beginning and end a different pattern than the center, if preferred.

Before starting the scarf, start by introducing a piece of carboard of approximately 12 cm (5") in the shed to save the fringes.

When finished and taken off the loom, make a sewing on each end before cutting to prevent unweaving and press with a steam iron.

The scarf is ready to wear and samples to display.

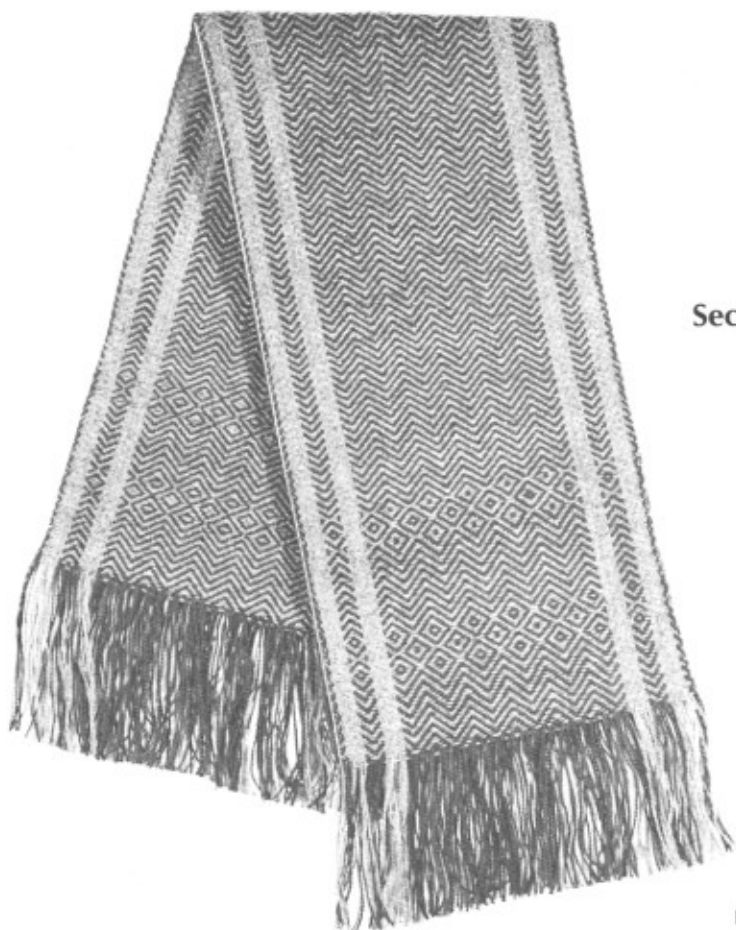

Second project
Scarf

Fig. 507

First project
Place mat

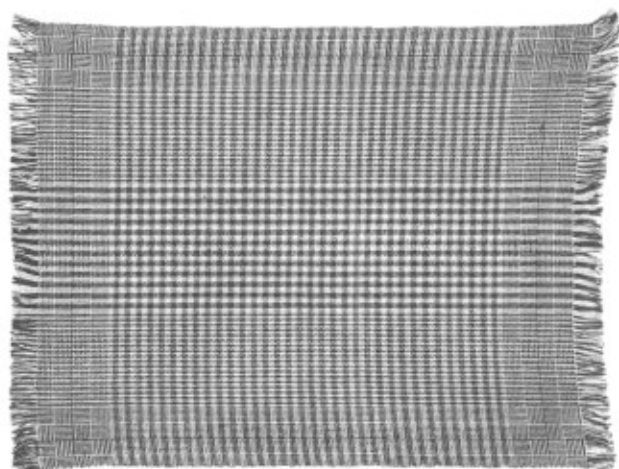

Fig. 507A

XVII COUNT AND SIZING

(Conversion from English to Metric system)

Thread sizes, yardages per pound, etc. on English system

Most weavers are puzzled about the yardage they may expect to find in each pound of the yarn they are using and also about what the different numbers mean on the labels. So perhaps a discussion of these items will not be amiss.

GRIST

Cotton and linen yarn, both in the warp and the weft yarns, are designated by numbers to show their grist, that is, their size. They may be purchased as single-ply or they may be plied, so we have 2-ply, 3-ply, 4-ply, etc. yarns. Speaking of identical fibers of the same ply, the higher the number, the finer the thread. A 20/2 in linen or cotton is, therefore, finer than a 10/2. At the mill, these fibers are spun so that there is a definite and known number of yards per pound. To spin a 2-ply yarn from a single ply yarn, the length, that is the yardage of the fiber per pound, is doubled upon itself and the two strands are then plied or twisted together in the spinning. Therefore, you can see that a 20/2 yarn, for instance, will have one-half the number of yards in each pound that the 20/1 fiber has.

Given the size of the yarn or as we say, the count and knowing the ply, you may use this simple formula to arrive at the yardage per pound. For cotton, the formula is based upon the fact that a pound of No. 1 single-ply (1/) yarn contains 840 yards. Therefore,

$$\text{Yardage per pound} = \frac{\text{Count} \times 840}{\text{The ply}}$$

$$\begin{aligned} \text{Solving } 20/2 \text{ cotton yarn, you} \\ \text{have: Yardage per pound} &= \frac{20 \times 840}{2} \\ &\text{or } 8400 \text{ yards.} \end{aligned}$$

For linen, the formula is based on the fact that single-ply No. 1 linen yarn contains 300 yards per pound, and this amount is known as a lea.

WOOLEN AND WORSTED YARNS

Unfortunately, the situation regarding these yarns is complicated. Encyclopedias list at least seven different systems in determining the count and yardages per pound.

The most frequent terms encountered here with regard to woollen yarns are cuts and runs. (No. 1) single-ply woollen yarn measures 300 yards and weighs one pound. The term run is used in another system. A run of No. 1 single-ply woollen yarn weighs one pound and measures 1600 yards.

Worsted is a hard-twisted, smooth-surfaced yarn spun from long staple pure wool and is carded so that its fibers lie parallel to each other. The term may also apply to a similarly spun mixed yarn. The unit used with reference to this yarn is called a count. Each count of single-ply worsted yarn measures 560 yards and the number of the yarn depends upon how many counts of single-ply yarn there are in a pound.

On man-made fibers, the most common system used was the "denier". We did not mention this system to avoid the confusion of the various counts of these different yarns.

Buy enough yarn at once. Handweavers would do well to buy yarns directly from concerns which cater to them. We also advise you to order sufficient yarn for your project, as different dye lots will show up in the over-all color of your weaving, as it does in your knitting. A small balance left may be useful, and running short may be a disaster on a large project.

Some information on the conversion of English measures to metric measures.

Reed: English system, the number of dents is determined per inch.

Metric system, the reed density is determined by cm. or 10 cm.

In the industry, they use the number of dents per 10 cm., as they may have 87, 111, 128 dents per 10 cm., but in handweaving we use the number of dents per cm. which is more simple as the assortment of dents is not so large, 2, 3, 4, 5, 6, 7, dents per cm. which can also be 2,5- 3,5- 4,5 etc. if needed.

TEX SYSTEM

The international system which applies to yarn is called "Tex system".

The Tex system is simpler and easier to memorize than the English system. The number of the yarn is determined by the weight in grams of 1000 meters. This means, the thicker the thread, the higher the number, as its weight is higher than that of a fine thread.

Cotton known on the English system as No. 1 becomes No. 590, as 1000 meters of it weighs 590 gr. but cotton No. 10 (English count) is now No. 59 as it weighs 59 gr. The No. 10 yarn is 1/10 of the weight of No. 1 yarn; as the Tex size of No. 1 is 590, it has to be divided by ten to give the Tex size of No. 10 yarn that is 59. This is exactly contrary to the English system.

The number of the ply does not change the count of the yarn; but 1000 meters of No. 59 (Tex), 2-ply cotton, will weigh 118 gr., and 1000 meters of No. 59, 4-ply cotton, will weigh 236 gr.

The number of the ply precedes the yarn number, i.e. a 2-ply yarn is called 2/59 and a 4-ply yarn is 4/59 which is the contrary to the English system (10/2 and 10/4).

The yarn may be indicated by "Z" if it is right hand twisted and by "S" if it is left hand twisted. Usually, the plied yarns are twisted contrary to the simply, Example: two yarns "Z" twisted will then be plied by an "S" twist.

The number of twists may also be indicated on the label. The number mentioned should be the number of twists per meter.

A yarn No. 2/59 S 400 means: 2-ply yarn No. 59 (59 gr. per 1000 meters) which has been plied on the left hand at 400 turns per meter. Usually, because the single ply was twisted on Z, the double ply was twisted on S.

The Tex size does not mean that cotton, wool, worsted, linen or man-made fibers are the same size if they have the same number, since they may vary according to the weight of the raw material. Example: No. 60 of a metal thread is much finer than a No. 60 wool thread.

To help you with the conversion of patterns from the English measurement to Metric system, we have designed the table on page 105.

Note: For standard count, the fractions on the weight per 1000 meters have been rounded.

APPENDIX

Count of threads most commonly used in weaving and conversion of the numbers in TEX system. Number of yards per pound and number of metres per kilogram.

COTTON - RAYON				WOOL				HEMP - JUTE - RAMIE LINEN THREAD			
ENGLISH		TEX		ENGLISH		TEX		ENGLISH		TEX	
Number of yards per pound	Size	Size	Equivalent in metres per kilogram	Number of yards per pound	Size	Size	Equivalent in metres per kilogram	Number of yards per pound	Size	Size	Equivalent in metres per kilogram
840	1	590	1695	560	1	886	1129	300	1	1660	602
8400	10	59	16949	5600	10	89	11287	3000	10	166	6024
4200	10/2	2/59	8475	2800	10/2	2/89	5618	1500	10/2	2/166	3012
3360	8/2	2/74	6757	3360	6/1	148	6757	2250	15/2	2/111	4505
6720	16/2	2/37	13514	5040	9/1	98	10204	2700	18/2	2/92	5435
8400	20/2	2/30	16667	3360	12/2	2/74	6757	3000	20/2	2/83	6024
2800	10/3	3/59	5650	4200	15/2	2/59	8475	6000	40/2	2/42	11905
5600	20/3	3/30	11111	4480	16/2	2/55	9091	4000	40/3	3/42	7937
6720	24/3	3/25	13333	8960	32/2	2/28	17857	6000	60/3	3/28	11905
8400	30/3	3/20	16667	2240	12/3	3/74	4505	3600	12	138	7246
14000	50/3	3/12	27778	1400	10/4	4/89	2809	4200	14	119	8403
840	4/4	4/148	1689	2240	8/2	2/110	4545	4800	16	104	9615
1680	8/4	4/74	3378					5400	18	92	10870
2520	12/4	4/50	5000					6000	20	83	12048
3280	16/4	4/37	6757					9000	30	55	18182
2240	16/6	6/37	4505					3750	25/2	2/66	7576
2800	20/6	6/30	5556					1800	12/2	2/138	3623
280	4/12	12/148	563								

Fig. 508

THINK METRIC

The metric measurement will be used all over the world within a few more years, we should get familiarized to its application in handweaving.

Metric measurements should be completed in Canada by 1980, we do not know the deadline for the United States.

Many changes will have to be made to integrate the metric system. The most important change for the weaver is the reed, since it determines the number of ends to be warped, and the count of yarns.

On the following page there is a table for comparison of reeds and the difference of the number of ends when warping.

The first column gives the standard dents per inch.

The second column gives the standard dents per centimeter.

The third column gives the exact equivalence in inches of the dents per centimeter of the second column.

Other columns gives the number of threads to warp to obtain the width mentioned in the two first horizontal lines.

The first horizontal line gives the weaving width in inches.

The second horizontal line gives the exact equivalence in centimeters.

If the item you want to weave is a twill pattern, you will have a variation in the width of your material, although you warp the exact number of threads given in your pattern.

Example: Material 40" wide, one thread per dent, 12 dents per inch reed.

It gives 480 threads. Now if you have a 5 dent per centimeter reed and you warp 480 threads, your material will be 37-13/16" wide (width in reed). If you wish to obtain the exact width, i.e. 40", you should warp 508 threads. The number mentioned in parenthesis is obtained by multiplying the corresponding number of dents per centimeter by the exact equivalence in centimeter of the desired width.

If it is a material with designs such as Colonial Overshot, Damask, Summer & Winter, by warping the exact number of threads given in your pattern, the width of your material will be reduced. If you want to keep the exact width, you must make some modifications on the block by adding a few ends where it is possible, without deteriorating the pattern. This can be done on the main part as well as on the border. The book "Creative Weaving" by Robert Leclerc will be very useful to know to make these modifications.

WARPING TABLE

Peus au pouce	Peus au cm	Equivalence en pouce	LARGEUR - WIDTH											
Dents per inch	Dents per cm	Equivalent in inches	8" 20,32 cm	10" 25,4 cm	20" 50,8 cm	26" 66,04 cm	32" 81,28 cm	36" 91,44 cm	40" 101,6 cm	42" 106,68 cm	45" 114,3 cm	50" 127 cm	54" 137,16 cm	60" 152,4 cm
5	2	5.08	40 7 7/8" (41)	50 9 13/16" (51)	100 19 11/16" (102)	130 25 5/8" (132)	160 31 1/2" (163)	180 35 7/16" (183)	200 39 3/8" (203)	210 41 5/16" (214)	225 44 1/4" (229)	250 49 1/4" (254)	270 53 1/8" (275)	300 59 1/16" (305)
8	3	7.62	64 8 3/8" (61)	80 10 1/2" (76)	160 21" (163)	208 27 1/4" (198)	256 33 9/16" (244)	288 37 13/16" (276)	320 42" (306)	336 44 1/8" (320)	360 47 1/4" (343)	400 52 1/2" (381)	432 56 11/16" (411)	480 63" (458)
10	4	10.16	80 7 7/8" (82)	100 9 13/16" (102)	200 19 11/16" (203)	260 25 5/8" (264)	320 31 1/2" (325)	360 35 7/16" (366)	400 39 3/8" (407)	420 41 5/16" (427)	450 44 1/4" (458)	500 49 1/4" (508)	540 53 1/8" (549)	600 59 1/16" (610)
12	5	12.7	96 7 9/16" (102)	120 9 7/16" (127)	240 18 7/8" (254)	312 24 9/16" (330)	384 30 1/4" (407)	432 34" (457)	480 37 13/16" (508)	504 39 11/16" (533)	540 42 1/2" (572)	600 47 1/4" (635)	648 51" (686)	720 56 11/16" (762)
15	6	15.24	120 7 7/8" (122)	150 9 13/16" (153)	300 19 11/16" (305)	390 25 5/8" (396)	480 31 1/2" (488)	540 35 7/16" (549)	600 39 3/8" (611)	630 41 5/16" (641)	675 44 1/4" (686)	750 49 1/4" (782)	810 53 1/8" (824)	900 59 1/16" (915)
18	7	17.78	144 8 1/8" (143)	180 10 1/8" (179)	360 20 1/4" (356)	468 26 5/16" (483)	576 32 3/8" (570)	648 36 7/16" (640)	720 40 1/2" (712)	756 42 1/2" (748)	810 45 9/16" (801)	900 50 5/8" (889)	972 54 9/16" (961)	1080 60 11/16" (1068)
20	8	20.32	160 7 7/8" (163)	200 9 13/16" (204)	400 19 11/16" (407)	520 25 5/8" (528)	640 31 1/2" (651)	720 35 7/16" (732)	800 39 3/8" (813)	840 41 5/16" (856)	900 44 1/4" (915)	1000 49 1/4" (1018)	1080 53 1/8" (1098)	1200 59 1/16" (1220)

Fig. 509

XVIII GLOSSARY

(In parenthesis, the French translation)

- Apron:** (Allonge) A piece of canvas attached to the warp and cloth beams, long enough to nearly reach the harness frames, used to prevent waste of warp.
- Beater or batten:** (Battant) The frame which holds the reed in place.
- Beam:** (Ensouple) Part of a loom; any of the large rollers on which either warp or finished cloth is wound.
- Beaming:** (Enroulage, pliage) Winding the warp on the loom.
- Beat:** (Frapper) One movement of the beater forward and back.
- Block:** (Bloc) Group of two warps or wefts making a design in the weave. Example: in the Summer and Winter, each complete square.
- Blotch:** (Sauté) Synonym: Scob, a spot on the fabric where the weft misses a few warp threads.
- Bobbin:** (Bobine, canette) Spool fitting inside a shuttle on which the weft is wound.
- Bobbin winder:** (Caneteuse) A device used to wind yarn on bobbins or spools.
- Bore:** (Enroulage) Length of warp that is moved forward by releasing the brake and using the take-up motion handle to advance the warp.
- Brake:** (Frein) Mechanic which prevents warp beam from unrolling and keeps the tension.
- Breast beam:** (Poitrinière) Part of the loom frame, over which the web passes before it is wound on the cloth beam.
- Catalogne:** (Catalogne) French term for material made out of rags on weft and cotton warp. Usually made for rugs and runners, upholstery, drapes and bed spreads.
- Chain:** (Chaîne) Same as warp. Usually the way to take up the warp from the warper to transfer it on the loom.
- Cloth:** (Matériel) Any woven fabric.
- Cloth beam:** (Ensouple avant) Beam in front of the loom on which finished cloth is wound.
- Count:** (Compte) Number of warp and weft threads, by surface measuring. Determination of size of yarns.
- Cross sticks:** (Baguettes d'encroix) Same as lease sticks.
- Damask:** (Damas) Weaving having drawings into relief. The weaving is reversible, but of a different look.
- Dent:** (Peu) Space in the reed or raddle.
- Dog:** (Cliquet) A device on beams to lock them in position and prevent them from rotating.
- Draft:** (Bref) A drawing representing threading, tie-up, treadling.
- Dressing the loom:** (Monter le métier) Preparing the loom for weaving.
- End:** (Bout, un fil) One yarn (thread) in the warp after cutting in the chain.
- Entering:** (Passage en ros) Same as sley.
- Eye:** (Oeillet) Central loop in a heddle through which a warp end is threaded.
- Float:** (Flotté) A warp or weft part which is not tied-up each other, to form the pattern (also called overshot).
- Floor loom:** (Métier à pédales) Same as foot power loom.
- Full:** (Fouler) After the weaving, the fabric is treated by the steam and pressed to shrink and thicken.

- Guild:** (Association) Professional organization for mutual cooperation of the members.
- Hand Loom:** (Métier opéré manuellement, métier de table) Any loom operated by hand as opposed to foot power.
- Hand Loomed:** (Tisser sur métier à navette volante) A term proposed to distinguish fabrics woven with a fly-shuttle, from "handwoven" fabrics.
- Hand shuttle:** (Navette à main) Any shuttle thrown by hand during weaving.
- Handtree:** (Chapeau du battant) Upper horizontal part of beater.
- Hand-woven:** (Tissé à la main) Woven with a hand shuttle.
- Harness:** (Lame) A single frame in which the heddles are placed on rods.
- Heddle:** (Aiguille, maille, lisse) Same as Mail Heald, Headle. Flat or round wire or cord with 3 eyes which carries each thread in the harnesses.
- Horse:** (Marmouset) A lever hung on a cord supporting harnesses on the counter-balanced loom instead of pulleys or rolls. Also for the lever take-up motion handles on the raising shed looms.
- Interlocking:** (Entrelacs) Ornament composed of interlaced designs making a continuous weave. Used with two or more shuttles coming from the opposite side, crossing the weft and going back on the same shed or in the next shed. Also commonly used on tapestry weaving.
- Jack:** (Bricoteau) Small lever on which the harnesses are directly hung up, either between themselves on a counter-balanced loom or tied against the lamms on a raising shed loom.
- Justers:** (Stabilisateur) Small wooden frame which keeps the harness in position during threading and slewing.
- Lamm:** (Contre-marche) A short lever placed under each harness of a foot-powered loom.
- Lease reed:** (Peigne envergeur) A combination of slots and holes in which threads are passed. Used for crossing during warping or in single or two way weaving.
- Lease Sticks:** (Baguettes de croisée) Flat wooden metal sticks with a very smooth finish used to hold the cross in order.
- Leno:** (Leno) Opening in the weaving made by the warp crossings and held by the weft.
- Loom:** (Métier) Machine or frame which keeps warp in proper position during weaving.
- Mercerizing:** (Mercerisé) Treatment of cotton or linen yarn to make it silky and shiny.
- Pattern:** (Patron) Plan giving information such as threading, tie-up, treadling, density of warp, and any other information related to a cloth.
- Pick or shot:** (Duite) One thread of weft.
- Power loom:** (Métier mécanique) Any loom operated by electricity or other artificial energy.
- Quill:** (Bobine) A paper cylinder used in a hand shuttle instead of a bobbin.
- Raddle:** (Peigne, râteau, vautoir) A long wooden lath with pegs on one side used to spread the warp during beaming.
- Ratchet wheel:** (Tourillon) A wheel with teeth fastened to the end of warp or cloth beams, to be used with the dog.
- Reed:** (Ros) A comb, closed on both sides, and in which each thread of warp is passed. It is divided in even spaces, keeps the width of the material and the distance between each warp end.

- Reel or Swift:** (Dévidoir) A part of warping mill on which the warp is wound.
- Rigid heddle:** (Peigne envergeur) Same as lease reed.
- Roller:** (Rouleau) Top round piece from which harnesses are hung on counter-balanced loom.
- Rya:** (Rya) Norwegian knot used for rug or mural weave, made with wool cut in advance of a predetermined length. Example: wool of 10 cm long will make a 4 cm rya knot when knotted. Each knot is made around two warp threads and every rya row is held solidly in passing through two picks or more tabby between the knot rows.
- Shed:** (Pas, foule) The opening made on the warp by the movement of the harnesses.
- Shed stick:** (Baguette de croisée) Same as lease stick.
- Shedding:** (Envergure) Same as "crossing" The warp threads are placed alternately above and under the lease sticks.
- Shot:** (Duite) Passage of shuttle through the shed.
- Shuttle:** (Navette) The wooden piece which carries the weft thread across the warp, either by means of a bobbin or equivalent.
- Sizing:** (Encollage) Dipping the warp into a solution to make it more solid. Used specially with flax. Today we use glue or commercial sizing which we spread on the warp. In the Orient, they still use water in which the rice is boiled.
- Skein:** (Echeveau) Yarn wound on a swift or reel, to be prepared for dyeing, usually 1/4 of a pound.
- Skipped:** (Sauté) The warps or wefts which are not tied together or interlaced in weaving, either intentionally in the designs, or accidentally in the weave. (This happens especially when the tension is not regular on certain warps.)
- Slabstock:** (Porte-fil) Back horizontal beam in a loom.
- Sleying:** (Piquage) Passing the warp through the reed.
- Tabby:** (fil de liaison) Weft used between the design threads when there are some floats, to tie the weave together and make it more solid on overshot pattern and rya rug.
- Tabby weave:** (Armure, toile) Simplest weave possible alternating odd and even thread on warp regularly.
- Table loom:** (Métier de table) Small loom operated by hands only.
- Take up motion:** (Enroulage) The action of winding the woven cloth on the cloth beam.
- Taken:** (Pris) The weft or warp which is held or interlaced in design weaving. Ex.: taken or skipped.
- Tapestry bobbin:** (Flûte) Special bobbin used for the low warp tapestry.
- Tension:** (Tension) Uniform length of each warp end on loom.
- Testile:** (Textile) Any fiber used in weaving as well as the woven material.
- Texture:** (Texture) The way a fabric is made.
- Thread Count:** (Titrage des fils) Number of threads per square cm. or inch of fabric.
- Threading:** (Enfilage) The action of passing the warp-ends through the heddle-eyes.
- Tie-up:** (Attachage des pédales) An arrangement of ties connecting the lamms and treadles.
- Treadle:** (Marche, pédale) A pedal used to operate the harnesses to make a shed through which the shuttle will pass with weft thread.

- Treadling:** (Pédalage) The order in which treadles are depressed during weaving.
- Twill:** (Sergé) A weave in which warp and weft yarns pass over each other in units of two or more yarns.
- Twill weave:** (croisure) Interlacement of warp and weft yarns. A basic weave which produces a diagonal in texture which can be regular or broken. Twill needs at least 3 harnesses to be produced and can be developed according to the number of harnesses used.
- Tying-in:** (Attachage) Attaching warp to apron or canvas.
- Unweaving:** (Défaire le tissage) Removing weft from between warp ends, usually to correct a mistake in weaving.
- Warp:** (Chaîne) The threads which are wound on the loom and passed through the heddles and reed ready for weaving.
- Warp beam:** (Ensemble arrière) The roller or beam on which the warp is wound.
- Warping:** (Ourdissage) Preparing the warp.
- Warping board or warping frame:** (Cadre ourdissoir) A frame with pegs on which the warp is prepared.
- Warping mill:** (Moulinet à ourdir) Vertical or Horizontal reel on which the threads are wound to prepare the warp, usually adjustable for different length of warp.
- Weave or weaving:** (Tisser) The action of operating the loom to produce a fabric.
- Weft:** (Trame) Thread, bamboo, or other material going across warp in a fabric.
- Wick:** (Mèche) In the open weave technic following threads group, not tied in the open part of the weave.

LOOM LANGUAGE

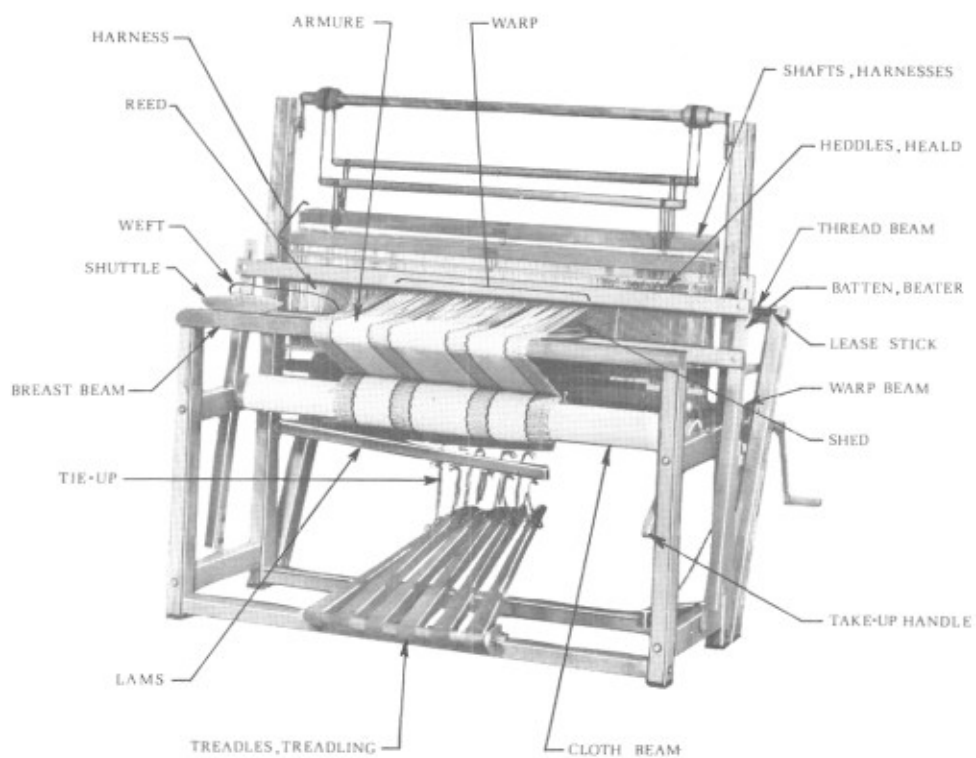

COUNTER-BALANCED LOOM

«FANNY» 4 harnesses model.

Leclerc 

LOOM PARTS

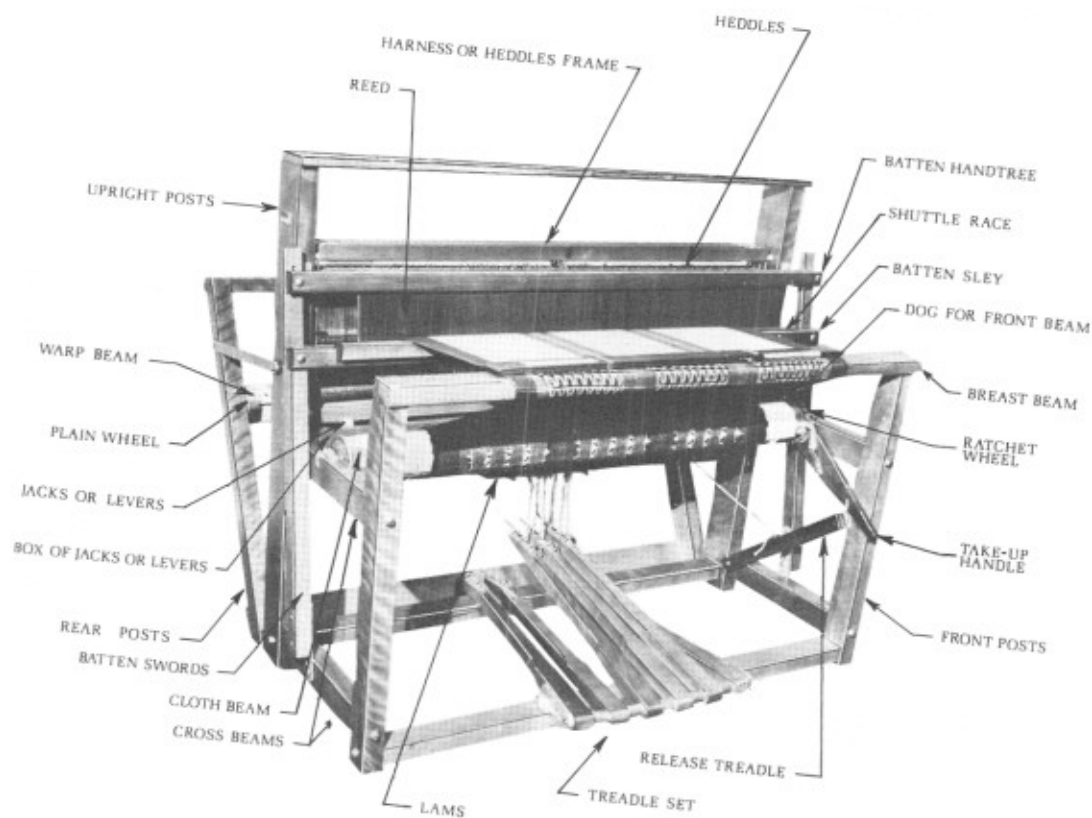

JACK TYPE LOOM

•NILUS• 4 harnesses model.

Leclerc 