

**National
Urban Search & Rescue (US&R)
Response System**

**RESCUE
FIELD OPERATIONS GUIDE**



US&R-23-FG

RESCUE FIELD OPERATIONS GUIDE (ROG)

The Federal Emergency Management Agency (FEMA) identifies four levels of operational guidance for use by emergency teams and other personnel involved in conducting or supporting disaster operations. This document corresponds to the level highlighted in bold italics.

- | | |
|----------------|--|
| Level 1 | Overview: A brief concept summary of a disaster-related function, team, or capability. |
| Level 2 | SOP: A complete reference document detailing the procedures for performing a single function (Standard Operating Procedure), or a number of interdependent functions (Ops Manual). |
| Level 3 | <i>Field Operations Guide (FOG): A durable pocket guide, containing essential nuts-and- bolts information needed to perform specific assignments or functions.</i> |
| Level 4 | Job Aid: A checklist or other aid for job performance or job training. |

This document is consistent with and supports the Federal Response Plan for implementation of the Robert T. Stafford Disaster Relief and Emergency Assistance Act, 42 U.S.C. § 5121, *et seq.*

The most current copy of this document, including any change pages, is available through the FEMA Intranet in the National Emergency Management Information System (NEMIS) Reference Library (<http://nemis.fema.net>), under Response and Recovery/Policies and Guidance, Disaster Operations Guidance.

FOREWORD

This Rescue Field Operations Guide has been prepared to guide Department of Homeland Security (DHS)/Federal Emergency Management Agency (FEMA) Rescue personnel during Federal disaster response operations.

The National Urban Search and Rescue (US&R) Response System provides for the coordination, development, and maintenance of the Federal effort with resources to locate, extricate, and provide immediate medical treatment to victims trapped in collapsed structures; and to conduct other life saving operations.

This guide is designed to supplement the National US&R Response System Field Operations Guide, September 2003 (US&R-23-FG) which provides the US&R Response System methods of operation, organization, capabilities, and procedures in mobilization, on-site operations, and demobilization.

This guide provides a detailed reference for performing Rescue Operations. The content further elaborates on the content initially provided in US&R-23-FG.

Questions, comments, and suggested improvements related to this document are encouraged. Inquiries, information, and requests for additional copies should be directed in writing to the Department of Homeland Security, Federal Emergency Management Agency, Response Division, Operations Branch, 500 C Street SW, Washington, DC 20472

Introduction:

The Department of Homeland Security (DHS), Federal Emergency Management Agency (FEMA), developed the National Urban Search & Rescue (US&R) Response System to support the Emergency Support Function (ESF) #9 (Urban Search and Rescue) of the Federal Response Plan. Within this framework, resources are mobilized to respond to structural collapse and other incidents nationwide.

Document Purpose:

This DHS/FEMA US&R Rescue Operations Guide has been developed to support response resources during training and on missions. This guide supplements the National Urban Search and Rescue Response System FOG, September 2003 (US&R-2-FG). This guide is a compilation and summary of important strategic and tactical information, developed procedures, and reference material specifically for the performance of Rescue Operations.

Table of Contents

1.	Onsite Information	
1.	Personnel Assignments	2-1
2.	Radio Channels	2-2
3.	Team Briefing Components	2-3
4.	Squad POA Requirements	2-4
2.	Position Duties	
1.	RTM General Duties	3-1
2.	RTM On Site Duties	3-2 & 3
3.	RSO General Duties	3-4
4.	RSO On Site Duties	3-5
5.	Blank	3-6
3.	Medevac Procedures	
1.	Medevac Procedures	4-1 & 2
2.	Helicopter Hand Signals	4-3
3.	NATO Phonetic Alphabet	4-4
4.	BOO Setup	
1.	Requirements	5-1
2.	Priorities	5-2
3.	Assignments	5-3
4.	Responsibilities	5-4
5.	Setup Procedures	5-5
6.	Cache Procedures	5-6
7.	TFCP Procedures	5-7
8.	Medical Procedures	5-8
9.	Shelter Procedures	5-9
10.	Sanitation/Hygiene Procedures	5-10
11.	Community Tent Procedures	5-11
12.	Security/Hazards Procedures	5-12
13.	Tent Assignments	5-13
14.	Sample Layout	5-14
5.	RECON/Marking Systems	
1.	Strategic, Management & Search Markings	6-1
2.	Search & Recon Initial Tasks	6-2
3.	Structure ID	6-3 & 4
4.	FEMA Structures/Hazards Marking	6-5
5.	FEMA Search Assessment Marking	6-6 & 7
6.	FEMA Victim Location Marking	6-8
7.	INSARAG Structure Assessment Marking	6-9
8.	INSARAG Victim Location Marking	6-10
9.	Recon Team Make-Up	6-11
10.	Recon Operations	6-12
11.	Site Assessment Forms	6-13 & 14

Table of Contents (cont.)

6.	Rescue	
1.	“LCES”	7-1
2.	Weight, Anchors & Bolting	7-2
3.	Sling Angles	7-3
4.	Sling Arrangements and Safe Working Loads	7-4
5.	Crane Signals	7-5
6.	Cribbing	7-6
7.	Shore Examples	
	Window/Door Shore	7-7
	Window/Door Prefab Shore	7-8
	Temporary “T” Shore	7-9
	Double “T” Shore	7-10
	Vertical Shore	7-11
	Lace Post Shore	7-12
	Horizontal Shore	7-13
	Flying Raker Shore	7-14
	Split Sole Raker – U-Channel Base	7-15
	Split Sole Raker – Trough Base	7-16
	Solid Sole Raker	7-17
	45 Degree Raker Strut Lengths	7-18
	60 Degree Raker Strut Lengths	7-19
	Raker Shore Lacing and Bracing	7-20
	Sloped Floor Shore Perpendicular Type I	7-21
	Sloped Floor Shore Perpendicular Type II	7-22
	Sloped Floor Shore Friction	7-23
	Gusset Plate, Lacing & Bracing Nail Patterns	7-24
	Cleat Nail Patterns	7-25
	Split Sole Raker Base Alternatives	7-26
8.	Activity Log Forms (2 sided)	8-1 & 2
9.	Miscellaneous Information	
	Signs, Symptoms & Treatment for Exposure	9-1
	Directions for Mark I Use	9-2
10.	Emergency Procedures	
	General Cordon Markings	10-1
	Evacuation Signals	10-2

Personnel Assignments

Rescue Squad:	
Squad Personnel	
Officer:	
1(ASL):	
2:	
3:	
4:	
5:	
HM:	
Medic:	
TFL 1:	TFL 2:
RTM 1:	RTM 2:
LOG 1:	LOG 2:

Radio Channels

TFL 1	TFL 2
RTM 1	RTM 2
LOG 1	LOG 2
MED 1	MED 2
BOO 1	BOO 2

Team Briefing Components

Situation / Hazard Evaluation:

Operational Period Objectives:

Site Control / Required PPE:

Logistical Support:

Emergency Signals / Procedures:

EMS Plan:

HAZ MAT Concerns:

Communications:

Sketch/Notes:

Squad POA Requirements

- **Sign in/Check in**
- **Personal Pack inspection**
- **Vehicle keys**
- **Contact Information sheet**
- **Family Support Team information sheet**
- **Medical review/Shot Record**
- **MRE/Water**
- **Communications equipment issue**
- **Passport (if required)**
- **Brief Relief issue**

Rescue Team Manager

General Duties

- **Reports to TFL**
- **Provide input to assist the TFL in developing the tactical objectives**
- **Coordinate and supervise operations necessary to achieve the tactical objectives**
- **Determine logistical and organizational needs**
- **Receive briefings and SITREPs from TFL**
- **Brief assigned personnel**
- **Provide situation updates and maintain reports**
- **Prepare evaluations for assigned personnel**

Rescue Team Manager

On Site Duties

- **Overall assessment process to determine:**
 - **Functional requirements**
 - **Work schedules and rotation periods**
 - **Adequacy of support facilities**
- **Coordinate activities with Search & Recon**
- **Assist in development of team action plan**
- **Coordinate objectives and personnel assignments**
- **Ensure proper worksite setup, control & safety**
- **Evaluate operations and modify as needed**
- **Evaluate capacity of resources to complete assignment**
- **Order additional resources as needed**

Rescue Team Manager

On site Duties (cont.)

- **Resolve coordination, personnel and communication issues**
- **Provide periodic progress reports to the TFL**
- **Identify completion of assignments**
- **Identify availability of resources**
- **Submit daily reports to Plans**
- **Ensure proper information exchange at relief or demob**
- **Notify Logistics of equipment, supply or maintenance issues**

Rescue Squad Officer

General Duties

- **Reports to Rescue Team Manager**
- **Appoint Assistant Squad Leader (ASL)**
- **Implement rescue component of the Team Action Plan**
- **Coordinate and supervise assigned personnel at worksites**
- **Determine organizational and logistical needs**
- **Provide situation updates and maintain reports**
- **Evaluate and modify rescue tactics and methods as needed**
- **Prepare evaluations for assigned personnel**

Rescue Squad Officer

On Site Duties

- **Coordinate logistical requirements with Rescue Team Manager and Logistics**
- **Determine availability of resources**
- **Evaluate capacity to complete assignment**
- **Order additional resources as needed**
- **Make periodic progress reports to the Rescue Team Manager**
- **Submit daily reports and records to Plans**
- **Ensure proper information exchange at relief or demob**
- **Notify Rescue Team Manager of equipment, supply or maintenance issues**

NOTES:

Medevac Procedures

Select and Secure Landing Site:

- Size depends on number and type of aircraft
- Ground slope <15 degrees
- Ensure surface free of rocks and debris
- Avoid dust, sand and snow
- Ensure ground firm enough to prevent aircraft from bogging down during loading/unloading
- At approach/departure ends, clearly mark obstructions that cannot be removed
- Ensure 10:1 horizontal clearance to vertical obstructions
- Mark landing/touchdown site
- Use smoke, signalman and or lights
- When dark, mark touchdown point with inverted “Y” composed of four lights

Medevac Procedures

Night Marking of Landing Zones

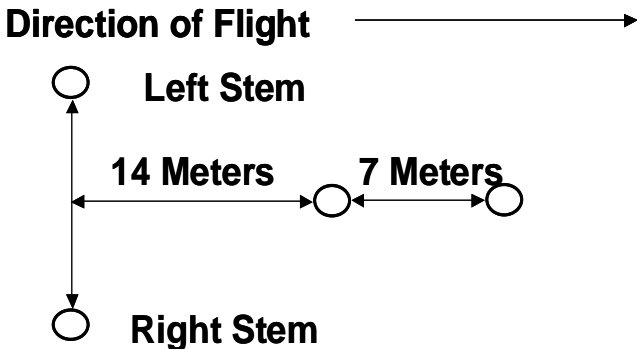

Note: The touchdown point will be midpoint of the legs of the “Y”. If more than 1 small aircraft will land, add 1 additional light at the exact point each is to land. If more than 1 large aircraft will land, add 2 lights placed 10mm apart aligned in the direction of flight.

Helicopter Hand Signals



**CLEAR TO START
ENGINE**



**HOLD ON
GROUND**



**MOVE
UPWARD**



**MOVE
DOWNWARD**

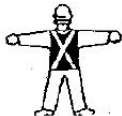

**HOLD
HOVER**



**CLEAR TO
TAKE OFF**



**LAND HERE, MY BACK
IS INTO THE WIND**



**MOVE
FORWARD**



**MOVE
REARWARD**



**MOVE
LEFT**



**MOVE
RIGHT**



**MOVE TAIL
ROTOR**



**SHUT OFF
ENGINE**



**FIXED TANK
DOORS**



**RELEASE
SLING LOAD**



**WAVE OFF
DO NOT LAND**

NATO Phonetic Alphabet

A - Alpha	N - November
B - Bravo	O - Oscar
C - Charlie	P - Papa
D - Delta	Q - Quebec
E - Echo	R - Romeo
F - Foxtrot	S - Sierra
G - Golf	T - Tango
H - Hotel	U - Uniform
I - India	V - Victor
J - Juliet	W - Whiskey
K - Kilo	X - X-ray
L - Lima	Y - Yankee
M - Mike	Z - Zulu

BOO Site Requirements

Preferred Size 200x200ft (61x61m)

Minimum size 110x150ft (33.5x46m)

- **Cultural/social considerations**
- **Access to work sites**
- **Runoff/flooding**
- **Noise considerations**
- **Utilities**
- **Damaged structures**
- **Prevailing winds/air hazards**

BOO Setup Priorities

Task	Priority
▪ Cache setup and organization	1
▪ Task Force Command Center	1
▪ Medical	1
▪ Personnel Shelters	1
▪ Sanitation/Hygiene	2
▪ Community Tent	3
▪ Canine Shelter	3
▪ Security/Hazards (constant)	N/A

BOO Setup Assignments

- **Squad 1:**
 - Assigned to tent _____

- **Squad 2:**
 - Assigned to tent _____
 - Personnel Shelter setup (Priority 1)

- **Squad 3:**
 - Assigned to tent _____
 - Cache setup & organization (Priority 1)

- **Squad 4:**
 - Assigned to tent _____
 - Cache setup & organization (Priority 1)

BOO Setup Responsibilities

- **Site Requirements (Immediate)**
 - Task Force Leader, Rescue Team Manager, Log Chief & Comm Specialists
- **Cache Setup and Organization (Priority 1)**
 - Log Chief, Log Specialists, Squads 3 & 4
- **TFCC Setup (Priority 1)**
 - Task Force Leader, Plans Chief, Comm Specialists, Technical Info Specialist & Safety
- **Medical Treatment Area Setup (Priority 1)**
 - Medical Manager & Medical Specialists
- **Personnel Shelter Setup (Priority 1)**
 - Squad 2
- **Sanitation/Hygiene Issues (Priority 2)**
 - Safety
- **Canine Exercise Area (Priority 3)**
 - Search Team Manager & Canine Specialists
- **Community Tent Setup (Priority 3)**
 - Log Chief & Technical Info Specialist

BOO Setup Procedures

- **Preferred Size, 200x200ft (61x61m)**
- **Minimum Size, 110x150ft (33.5x46m)**
- **Utilize Advance Team Kit**
 - **2 - 100ft tapes, roll fireline tape, BOO signs, digital camera, vests, chalk, binoculars & paint**
- **Layout and identify sections with signs and fireline tape**
- **Entrance should be adjacent to main access or travel route**
- **Mark ground for location, dimension and spacing of each section and tent**
- **Identify travel/access routes Ensure fire extinguishers and signs are present**
- **Generators placed on perimeter near section to be powered**
- **Identify remote fuel storage area**
- **Post signs for all sections and each tent**

BOO Setup (Cache) Procedures

- **Size (approximately) 50x60ft (15x18m)**
- **Layout/mark Cache area adjacent to BOO entrance and main travel/access**
- **Post conspicuous sign**
- **Mark perimeter with fireline tape and establish entry control point**
- **Mark location/layout for cache setup**
 - **4 rows Rescue**
 - **1 row Technical**
 - **1 row WMD (as needed)**
 - **1 row Logistics**
- **Erect 19x35ft Western Shelter tent for weather sensitive equipment and office**
- **Provide electricity and light**
- **Identify empty boxes for counter space/seating**
- **Provide tarps/sheeting for weather/security**

BOO Setup (TFCP) Procedures

- **Size (approximately) 40x30ft (12x9m)**
- **Mark perimeter with fireline tape and post sign**
- **Identify high ground/elevated structures for communications**
- **Erect 2 19x19ft Western Shelter tents**
- **Provide electricity and light**
- **Retrieve/setup all office supplies and forms**
- **Establish the following:**
 - **Command and Control**
 - **Workspace**
 - **Communications**
 - **Equipment setup**
 - **Plans/Technical Information workspace**

BOO Setup (Medical) Procedures

- **Size (approximately) 25x50ft (7.5x15m)**
- **Mark perimeter with fireline tape and post sign**
- **Erect 19x35ft Western Shelter tent**
- **Provide electricity and light**
- **Establish the following:**
 - **Patient treatment area, with privacy**
 - **Acute care equipment**
 - **Office workspace with shelving and seating**

BOO Setup (Shelter) Procedures

- **Size (approximately) 80x110ft (24x33.5m)**
- **Mark perimeter with fireline tape and post sign**
- **Erect Personnel Shelter tents**
- **Provide electricity and lighting**
- **Provide smoke & carbon monoxide detectors and fire extinguishers**
- **Affix identification signs to tents**
- **Consider weather and runoff issues**

BOO Setup (Sanitation/Hygiene) Procedures

- **Size (approximately) 25x25ft (7.5x7.5m)**
- **Mark perimeter with fireline tape and post sign**
- **Setup a minimum of 4 “Brief Relief” stations**
- **Provide lighting**
- **Set up hand washing and or wet wipe stations**
- **Place trash receptacles throughout BOO (segregate food scraps)**
- **Setup up Gross decon station at BOO entry points**
- **Request trash collection from local resources**
- **Collect and dispose of trash 2x daily (segregate food scraps)**
- **Request “Port-A-Potties” from local resources**

BOO Setup (Community Tent) Procedures

- **Size (approximately) 25x35ft (7.5x10.5m)**
- **Mark perimeter with fireline tape and post sign**
- **Erect 19x35ft Western Shelter tent**
- **Provide electricity and lighting**
- **Establish seating/eating area**
- **Establish hand washing/clean up area**
- **Setup up task force bulletin boards**

BOO Setup (Security/Hazards) Procedures

- **Identify/Mark Hazards within or adjacent to the BOO**
- **Isolate fuel storage**
- **Provide fire extinguisher at fuel storage and refueling locations**
- **Post “No Smoking” signs as appropriate**
- **Cover cache, supplies and equipment as appropriate**
- **Request additional generators/lighting for improved safety/security**
- **Post and announce plan for evacuation and assembly points**
- **Identify availability of local police/military**

BOO Setup Tent Assignments

Assignment	Tent
▪ TFL, RTM, Safety, Plans, TIS ENG	A
▪ TFL, RTM, Safety, Plans, TIS ENG	B
▪ Squad 3 & HM Specialist	C
▪ Squad 1 & HM Specialist	D
▪ Squad 4 & Driver/Mechanic	E
▪ Squad 2 & Driver/Mechanic	F
▪ Canine Specialists & Canines	G
▪ STM, Search Specs. & HER Spec.	H
▪ Non-Task Force Personnel	I
▪ Medical Personnel	Medical
▪ Communications Personnel	Comm
▪ Logistics Personnel	Log

Tent Assignments and Sample Layout

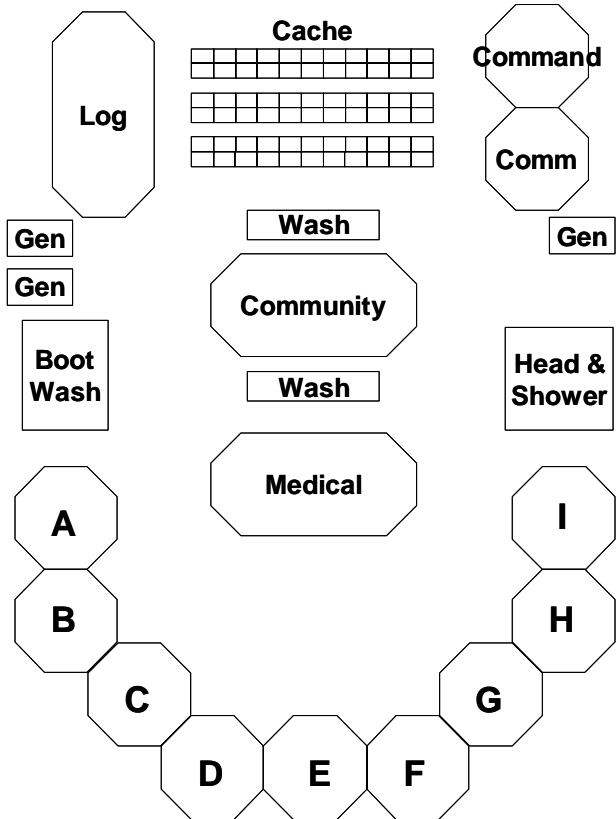

Strategic Considerations

The most effective rescue strategy should blend all viable tactical capabilities into a logical plan of operation. The general strategic considerations are outlined as follows:

Rescue Site Management and Coordination

Each rescue work site must have one person in charge to maintain unity of command. The Rescue Squad Officer of each rescue squad is responsible for all activities of the assigned rescue site including safety when a single squad operates alone. At large or complex rescue operations that require the commitment of two or more rescue squads to a single operation, the Rescue Team Manager may assume command or assign one of the Rescue Squad Officers to be in charge of the site. A Safety Officer should be identified at each rescue site.

Search Phases

There are generally five phases of organized search and rescue operations at collapse incidents:

- **Phase One:** Assessment of the collapse area.
- **Phase Two:** Removal of all surface victims as quickly and safely as possible.
- **Phase Three:** Search and rescue of victims from accessible void spaces.
- **Phase Four:** Selected debris removal to locate and rescue victims.
- **Phase Five:** General debris removal. Usually conducted after all known victims have been removed.

Recon Initial Tasks

- **Area sketch/map and building ID (if no structure triage)**
- **Structural/Hazard evaluation and marking**
- **Building sketch/plan, include building cross section**
- **Building type/configuration, include size & stories**
- **Building occupancy type**
- **Collapse type**
- **Void locations**
- **Hazard locations**
- **Best access**
- **Hazard mitigation notes**

Structure Identification

If no numbers known, use low #'s

900 902 904 906 908

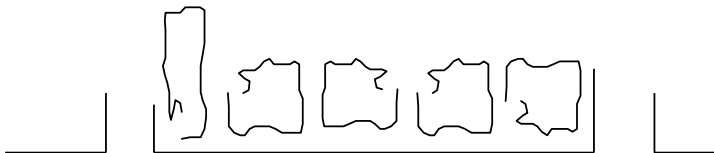

800

900

1000

Block Alpha Street

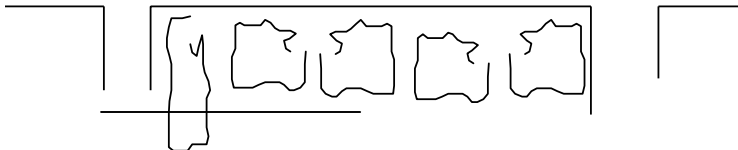

901 903 905 907 909

Structure Identification (Cont.)

Side ID

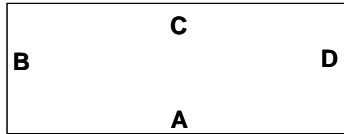

Front

Quadrant ID

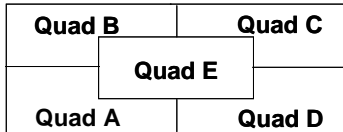

Front

Floor ID

Floor 3
Floor 2
Floor 1
Basement 1
Basement 2
Basement 3

(Use arrow to designate best entry point)

Ground Level

FEMA Structures/Hazards Marking



- 2x2ft (60x60cm)
- Structure relatively safe for US&R operations

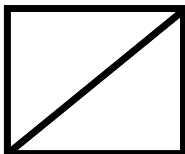

- Structure significantly damaged
- Shoring/removal of hazards may be required

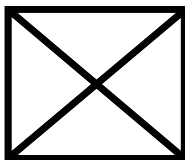

- Structure not safe for normal US&R operations
- Extensive safety measures must be taken before entry

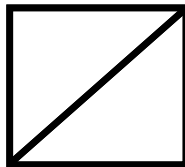

28 JUN 03
NATURAL GAS
1432HRS
NE-TF1

- To right of box:
 - Date
 - Hazards
 - Time
 - TF ID

FEMA Search Assessment Marking



PA-TF1
18SEP00
1800

- Single slash upon entry into structure
 - TF ID, date & entry time noted
 - Indicates ongoing search
-



18SEP00
2130

PA-TF1
18SEP00
1800

- Crossing slash upon exit
 - Upon exit, date and time noted in top field
 - Additional information placed in open areas of "X"
-



18SEP00
2130

PA-TF1
18SEP00
1800

RATS

8L
3D

- Right - hazards
 - Bottom - # of victims
-



18SEP00
2130

PA-TF1
~~18SEP00~~
1800

RATS

8L
3D

- When new search completed, cross out previous, and complete new search assessment marking
-

FEMA Search Assessment Marking

Incomplete Search Marking

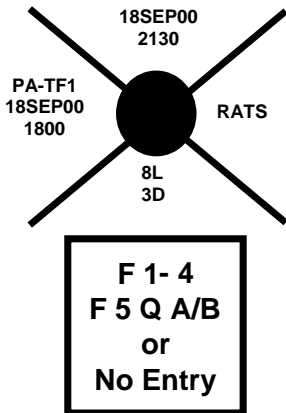

- When search terminated prior to completion:
 - Place filled circle at center of slash
 - Add date & time search terminated in top field
 - Note hazards to right
 - Note victims beneath
 - Place box below slash, & Note areas searched
 - Use “F” to ID floors searched
 - Use “Q” to ID quadrants searched
 - If only searched Exterior, as in Hurricane, write “No Entry” in box

FEMA Victim Location Marking

CA-TF2

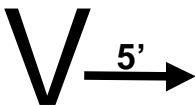

- “V” indicates potential victim location
 - Arrow may be used to pinpoint location, add distance on arrow.
-

CA-TF2

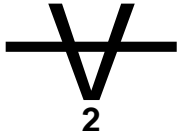

- Line through “V” indicates confirmed deceased victim. If more than one, mark total number under V.
-

CA-TF2

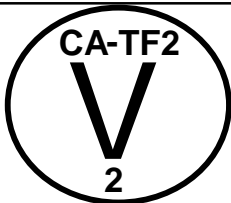

- Circle around “V” indicates confirmed live victim. If more than one, mark number under V.
-

CA-TF2



- Cross out marking when victim is removed.

INSARAG Structure Assessment Marking

Hazard information

Number
of live
victims
removed

<p>G or N (Go/No Go) Team ID Time/Date of start Time/Date of end</p>

Number
of dead
victims
removed

Persons unaccounted for:
Location of other victims:

***When operation is completed, the box is circled.**

INSARAG Victim Location Marking



- “V” near location of known or potential victims



L - 4
D - 3

- Below “V”:
 - Place “L” & # to denote live victims
 - Place “D” & # to denote dead victims



L - 4
D - 3



- Draw arrow to pinpoint confirmed victim
- Confirmation must be visual or audible, canine cannot confirm

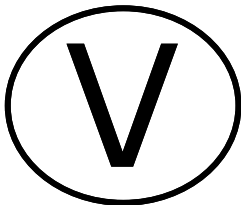

- Circle marking when last live victim is removed or place line through “V” when only dead victims remain

Recon Team Make-Up

- **Search Team Manager**
- **Technical Search Specialist**
- **Structures Specialist**
- **Medical Specialist**
- **2 Canine Search Teams**
- **Haz-Mat Specialist**
- **2 Rescue Specialists**

Recon Operations

- **Identify buildings**
- **Structure/hazards marking**
- **Area/building search**
- **Search/assessment marking**
- **Assess void space and atmospheric conditions**
- **Victim location identification**
- **Sketch search area and record information**
- **Communicate findings to appropriate manager**

Site Assessment

Date:	Time:	Site#:	
Type of Occupancy:			
GPS:			
# of levels:			
Above ground:			
Below ground:			
Possible # of victims/location:			
Hazards:			
Utilities controlled:			
Electricity	<input type="checkbox"/>	Water	<input type="checkbox"/>
Gas	<input type="checkbox"/>	Other	<input type="checkbox"/>

Other assets on site:

Witness reports/Intel/Notes:

Sketch:

Site Assessment

Date:	Time:	Site#:	
Type of Occupancy:			
GPS:			
# of levels:			
Above ground:			
Below ground:			
Possible # of victims/location:			
Hazards:			
Utilities controlled:			
Electricity	<input type="checkbox"/>	Water	<input type="checkbox"/>
Gas	<input type="checkbox"/>	Other	<input type="checkbox"/>

Other assets on site:

Witness reports/Intel/Notes:

Sketch:

Site Assessment

Date:	Time:	Site#:	
Type of Occupancy:			
GPS:			
# of levels:			
Above ground:			
Below ground:			
Possible # of victims/location:			
Hazards:			
Utilities controlled:			
Electricity	<input type="checkbox"/>	Water	<input type="checkbox"/>
Gas	<input type="checkbox"/>	Other	<input type="checkbox"/>

Other assets on site:

Witness reports/Intel/Notes:

Sketch:

Site Assessment

Date:	Time:	Site#:	
Type of Occupancy:			
GPS:			
# of levels:			
Above ground:			
Below ground:			
Possible # of victims/location:			
Hazards:			
Utilities controlled:			
Electricity	<input type="checkbox"/>	Water	<input type="checkbox"/>
Gas	<input type="checkbox"/>	Other	<input type="checkbox"/>

Other assets on site:

Witness reports/Intel/Notes:

Sketch:

Site Assessment

Date:	Time:	Site#:	
Type of Occupancy:			
GPS:			
# of levels:			
Above ground:			
Below ground:			
Possible # of victims/location:			
Hazards:			
Utilities controlled:			
Electricity	<input type="checkbox"/>	Water	<input type="checkbox"/>
Gas	<input type="checkbox"/>	Other	<input type="checkbox"/>

Other assets on site:

Witness reports/Intel/Notes:

Sketch:

Site Assessment

Date:	Time:	Site#:	
Type of Occupancy:			
GPS:			
# of levels:			
Above ground:			
Below ground:			
Possible # of victims/location:			
Hazards:			
Utilities controlled:			
Electricity	<input type="checkbox"/>	Water	<input type="checkbox"/>
Gas	<input type="checkbox"/>	Other	<input type="checkbox"/>

Other assets on site:

Witness reports/Intel/Notes:

Sketch:

Site Assessment

Date:	Time:	Site#:	
Type of Occupancy:			
GPS:			
# of levels:			
Above ground:			
Below ground:			
Possible # of victims/location:			
Hazards:			
Utilities controlled:			
Electricity	<input type="checkbox"/>	Water	<input type="checkbox"/>
Gas	<input type="checkbox"/>	Other	<input type="checkbox"/>

Other assets on site:

Witness reports/Intel/Notes:

Sketch:

Site Assessment

Date:	Time:	Site#:	
Type of Occupancy:			
GPS:			
# of levels:			
Above ground:			
Below ground:			
Possible # of victims/location:			
Hazards:			
Utilities controlled:			
Electricity	<input type="checkbox"/>	Water	<input type="checkbox"/>
Gas	<input type="checkbox"/>	Other	<input type="checkbox"/>

Other assets on site:

Witness reports/Intel/Notes:

Sketch:

Site Assessment

Date:	Time:	Site#:	
Type of Occupancy:			
GPS:			
# of levels:			
Above ground:			
Below ground:			
Possible # of victims/location:			
Hazards:			
Utilities controlled:			
Electricity	<input type="checkbox"/>	Water	<input type="checkbox"/>
Gas	<input type="checkbox"/>	Other	<input type="checkbox"/>

Other assets on site:

Witness reports/Intel/Notes:

Sketch:

Site Assessment

Date:	Time:	Site#:
Type of Occupancy:		
GPS:		
# of levels:		
Above ground:		
Below ground:		
Possible # of victims/location:		
Hazards:		
Utilities controlled:		
Electricity	<input type="checkbox"/>	Water <input type="checkbox"/>
Gas	<input type="checkbox"/>	Other <input type="checkbox"/>

Other assets on site:

Witness reports/Intel/Notes:

Sketch:

Site Assessment

Date:	Time:	Site#:	
Type of Occupancy:			
GPS:			
# of levels:			
Above ground:			
Below ground:			
Possible # of victims/location:			
Hazards:			
Utilities controlled:			
Electricity	<input type="checkbox"/>	Water	<input type="checkbox"/>
Gas	<input type="checkbox"/>	Other	<input type="checkbox"/>

Other assets on site:

Witness reports/Intel/Notes:

Sketch:

Site Assessment

Date:	Time:	Site#:	
Type of Occupancy:			
GPS:			
# of levels:			
Above ground:			
Below ground:			
Possible # of victims/location:			
Hazards:			
Utilities controlled:			
Electricity	<input type="checkbox"/>	Water	<input type="checkbox"/>
Gas	<input type="checkbox"/>	Other	<input type="checkbox"/>

Other assets on site:

Witness reports/Intel/Notes:

Sketch:

LCES

- **Lookouts**
 - Appoint site Safety Officer
 - Observe only
- **Communications**
 - Request radio channel(s)
 - Review evacuation signals
- **Escape Routes**
 - Pre-established path to safe area
- **Safe Zones**
 - Pre-established areas of refuge
 - Pre-identified assembly area

Weights of Common Building Materials

- **Reinforced Concrete Slabs** **150 pcf (67kg)**
- **Masonry** **125 pcf (56kg)**
- **Wood** **35 pcf (15kg)**
- **Steel** **490 pcf (220kg)**
- **Concrete or Masonry Rubble** **10 psf (4kg per inch of depth)**

Anchors and Bolting

- **Minimum edge distance** **6x diameter of bolt**
- **Minimum spacing** **12x diameter of bolt**
- **Minimum depth** **6x diameter of bolt**
- **Preferred depth** **9x diameter of bolt**

Effects of Sling Angles

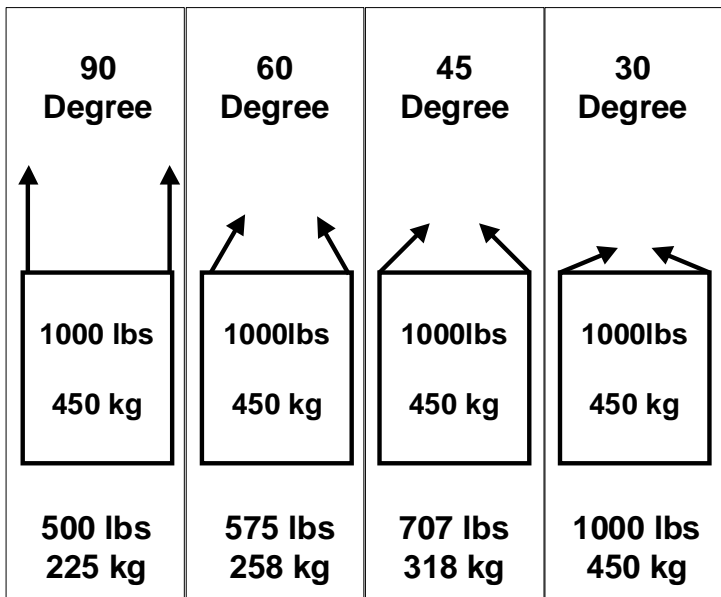

Amount of load on each leg

Sling Arrangements and Design Loads

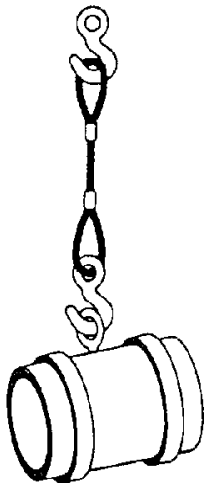

Vertical
1 x
Rating

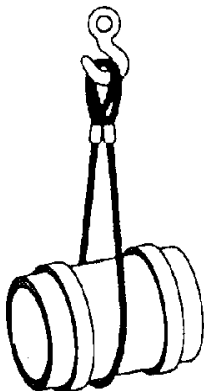

Basket
2 x
Rating

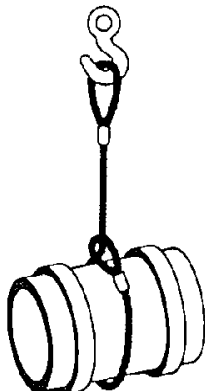











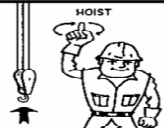
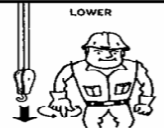

Choker
3/4 x
Rating

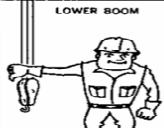
CRANE SIGNALS

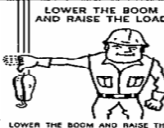
CRANE SIGNALS

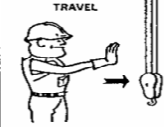
ALWAYS STAND IN CLEAR VIEW OF YOUR CRANE HOIST ENGINEER BE SURE TO STAY A SAFE DISTANCE FROM HOOK, BLOCK OR BOOM

Published by
SPECIALIZED CARRIERS & RIGGING ASSOCIATION
In accordance with the American National Standards Institute

 <p>USE MAIN HOIST</p> <p>USE MAIN HOIST: Tap fist on head, then use regular signals.</p>		 <p>USE WHIP LINE</p> <p>USE WHIP LINE: (Auxiliary Hoist) Tap elbow with one hand; then use regular signals.</p>		 <p>HOIST</p> <p>HOIST: With forearms vertical, forefinger pointing up, move hand in small horizontal circles.</p>		 <p>LOWER</p> <p>LOWER: With arm extended downward, forefinger pointing down, move hand in small horizontal circles.</p>	
 <p>RAISE BOOM</p> <p>RAISE BOOM: Arm extended, fingers closed, thumb pointing upward.</p>		 <p>LOWER BOOM</p> <p>LOWER BOOM: Arm extended, fingers spread, thumb pointing downward.</p>		 <p>MOVE SLOWLY</p> <p>MOVE SLOWLY: Use one hand to give any motion signal and place other hand motionless in front of hand giving the motion signal. (Hoist slowly shown as example)</p>		 <p>RAISE THE BOOM AND LOWER THE LOAD</p> <p>RAISE THE BOOM AND LOWER THE LOAD: With arm extended, thumb pointing up, flex fingers in and out as long as load movement is desired.</p>	
 <p>STOP</p> <p>STOP: Arm extended, palm down, move arm back and forth horizontally.</p>		 <p>EMERGENCY STOP</p> <p>EMERGENCY STOP: Both arms extended, palms down, move arms back and forth horizontally.</p>		 <p>TRAVEL</p> <p>TRAVEL: Arm extended forward, hand open and slightly raised, making pushing motion in direction of travel.</p>		 <p>DOG EVERYTHING</p> <p>DOG EVERYTHING: Clasp hands in front of body.</p>	
 <p>TELESCOPING BOOM ONE HAND</p> <p>EXTEND BOOM</p> <p>BOTH FISTS IN FRONT OF BODY WITH THUMBS POINTING OUTWARD</p>		 <p>TELESCOPING BOOM TWO HANDS</p> <p>RETRACT BOOM</p> <p>BOTH FISTS IN FRONT OF BODY WITH THUMBS POINTING FORWARD</p>		 <p>TELESCOPING BOOM ONE HAND</p> <p>EXTEND BOOM</p> <p>ONE HAND GRABBS ONE END OF ROPE WITH THUMB TAPPING CROSS</p>		 <p>TELESCOPING BOOM ONE HAND</p> <p>RETRACT BOOM</p> <p>ONE HAND GRABBS ONE END OF ROPE WITH THUMB POINTING OUTWARD AND END OF FIST TAPPING CROSS</p>	

Cribbing

- 4x4 - 6000lbs (2700kg) per full contact point
- 6x6 - 15,000lbs (6750kg) per full contact point
- Overlap corners by 4" (10cm)
- Up to 15 degree slope max. (3 feet in 10 feet)

Allowable Height to Width Ratios

- | | |
|---------------------|----------|
| ▪ All bearing | 3 to 1 |
| ▪ Lifting or moving | 2 to 1 |
| ▪ 2 of 4 bearing | 1.5 to 1 |
| ▪ 1 of 4 bearing | 1 to 1 |

Window/Door

- 1 - Header
 - 1 - Sole plate
 - 2 - Posts
 - 4 - Pair 2x4 wedges
 - 1 - Triangle Gusset
 - 3 - Cleats
 - 2 - Diagonals
- At least 1" (2.5cm) of header depth for each foot of horizontal opening spanned. (4x4 minimum)

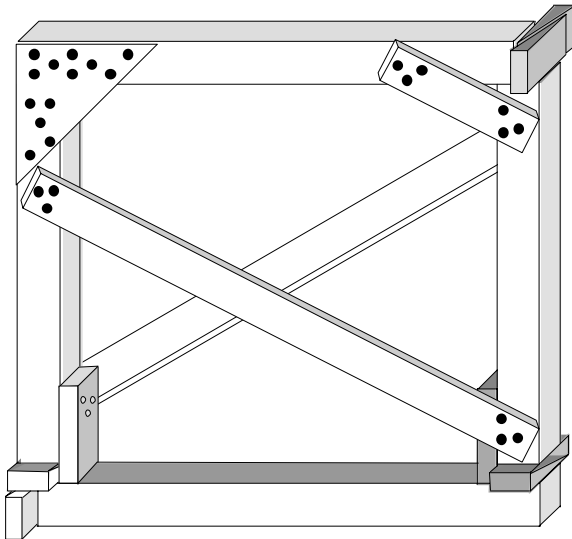

Window/Door Prefab

- 1 - Header
 - 1 - Sole plate
 - 2 - Posts
 - 5 - Pair 2x4 wedges
 - 8 - Triangle Gussets
- At least 1" (2.5cm) of header depth for each foot of horizontal opening spanned (4x4 minimum)

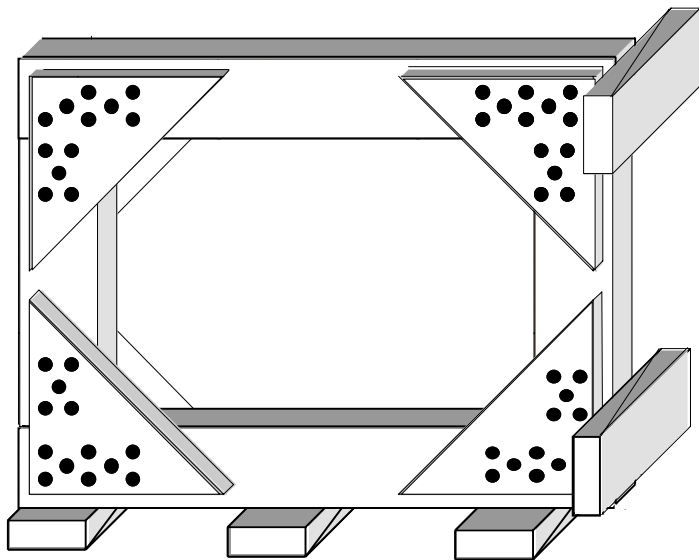

Temporary “T”

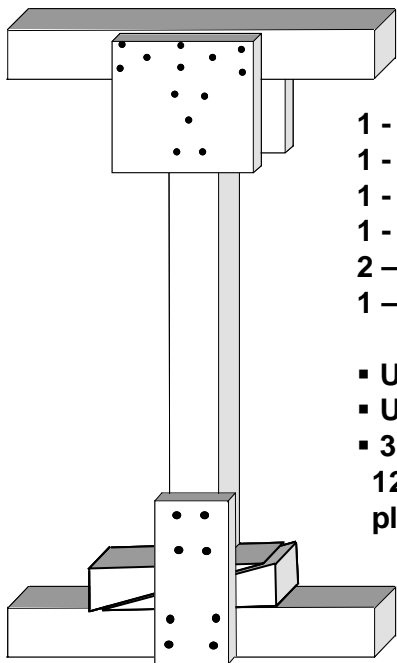

- 1 - Header**
- 1 - Sole plate**
- 1 - Post**
- 1 - Pair 2x4 wedges**
- 2 – Full-Gusset plates**
- 1 – Half-Gusset or Cleat**

- **Up to 11 ft (240cm) for 4x4**
- **Up to 16 ft (360cm) for 6x6**
- **3 ft header (90cm) gets
12x12 (30x30xcm) gusset
plates**

Double "T"

- 1 - Header
- 1 - Sole plate

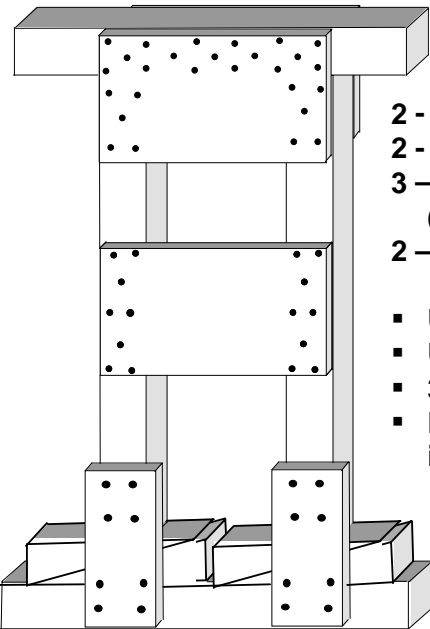

- 2 - Posts
- 2 - Pair 2x4 wedges
- 3 - Dbl-Gusset plates 12x24
(30x60cm)
- 2 - Half-Gussets or Cleats

- Up to 12 ft (240cm) for 4x4
- Up to 18 ft (360cm) for 6x6
- 3 ft header (90cm)
- Post Spacing is 18 to 24 inches out to out

Vertical

1 - Header

1 - Sole plate

3 - Posts

3 - Pair 2x4 wedges

5 - Half- Gussets

2 - 2x6 Diagonals

Mid point brace if

needed, use 1x6

or $\frac{3}{4}$ " x 6" ply strip

- Post spacing is 1ft per 1in of header depth on center (3-4ft or 90-120cm)
- Overhand of 1ft (30cm)
- Mid point brace needed for:
 - 4x4 over 8ft (240cm) tall
 - 6x6 over 12ft (360cm) tall

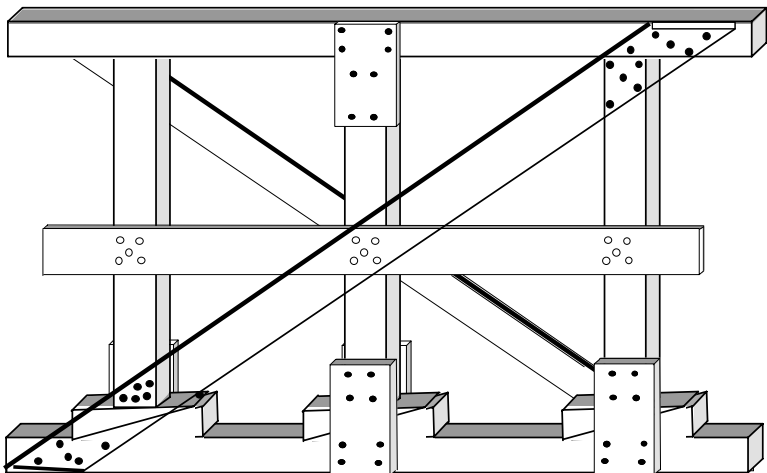

Laced Post

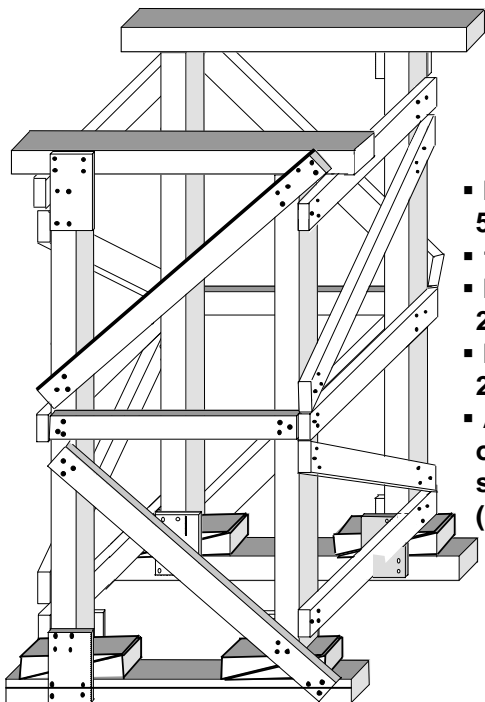

- 2 - Headers
- 2 - Sole plates
- 4 - Posts
- 8 - Horizontals
- 4 - Pair 2x4 wedges
- 8 - Diagonals
- 8 - Half- Gussets

- Post spacing is 3 to 5 feet (90 to 150cm)
- 1 ft (30cm) overhang
- Lacing/bracing is 2x4 for 4x4
- Lacing/bracing is 2x6 for 6x6
- Add one horizontal & one diagonal to each side if over 11 ft (330cm) tall

Horizontal

2 - Wall plates

3 - Struts

3 - Pair 2x4 wedges

7 - 4x4 wedges (9 if bottom strut not on floor)

1- Half-gusset
(or Cleat)

2 - Diagonals

1 - Cleat

▪ Shims go on
undamaged side

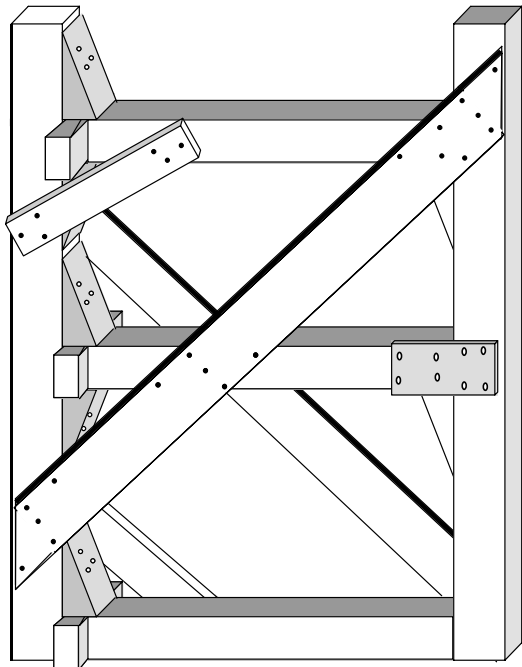

Flying Raker

- 1 - Wall Plate
- 1 - Raker strut
- 1 - Cleat
- 2 - Full- Gussets
- 2 - 2x6 Horizontal Braces
- 1 - U Channel Foot
- 1 - Pair 2x4 or 4x4 wedges

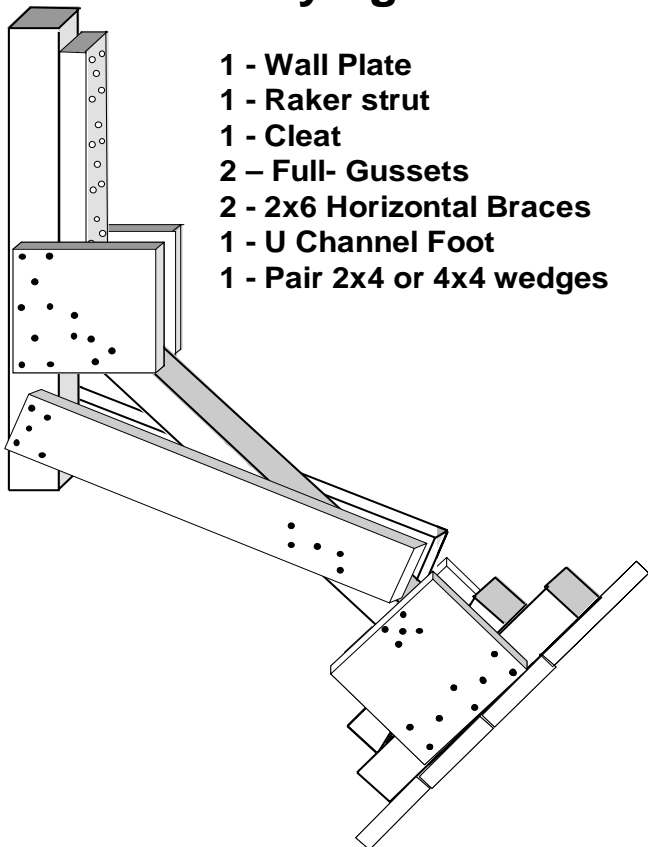

Split Sole Raker – U-Channel Base

- 1 - Wall Plate
- 1 - Raker Strut
- 1 - Cleat
- 2 – Full- Gussets
- 2 - 2x6 Horizontal Braces
- 2 - 2x6 Mid Point Braces
- 1 - U Channel
- 1 - Sole Plate
- 1 - Pair 2x4 wedges
(4x4 if needed)

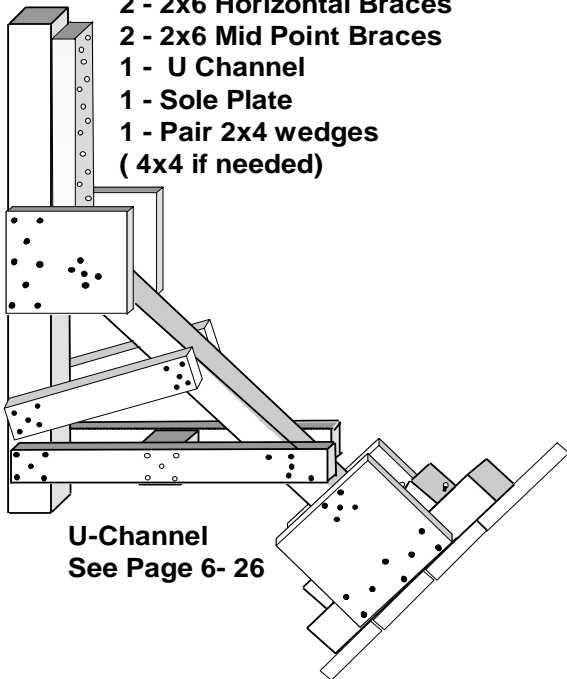

U-Channel
See Page 6- 26

Split Sole Raker – Trough Base

- 1 - Wall Plate
- 1 - Raker Strut
- 1 - Cleat
- 2 - Full- Gussets
- 2 - 2x6 Horizontal Braces
- 2 - 2x6 Mid Point Braces
- 1 - Trough Foot
- 1 - Sole Anch
- 1 - Pair 2x4 wedges
(4x4 if needed)

- Sole Anch 6x6x36 (90cm)
- 4 - 1" Pickets to soil
- 2 - 1" Pickets to Paving
- 4x4 up to 11 ft (330cm) without mid point bracing
- 6x6 up to 16 ft (480cm) without mid point bracing
- "X" or "V" bracing at each end & every 40 feet (13.5m) max.

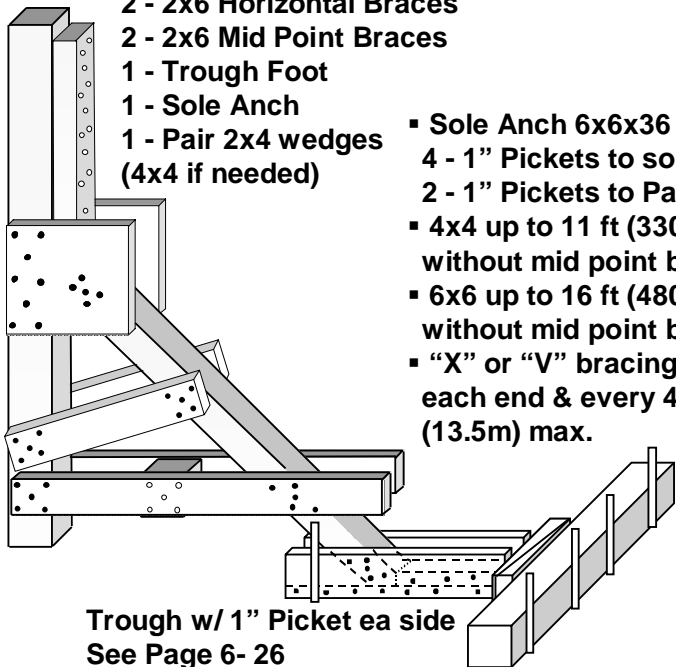

Trough w/ 1" Picket ea side
See Page 6- 26

Solid Sole Raker

- 1 - Wall plate
- 1 - Sole plate
- 1 - Strut
- 2 - Cleats
- 6 - Full- Gussets
- 2 - 2x6 diagonals
- 1 - Pair 2x4 or 4x4 wedges

- 4x4 up to 11 ft (330cm) without mid point bracing
- 6x6 up to 16 ft (480cm) without mid point bracing
- "X" or "V" bracing at each end & every 40 feet (13.5m) max.

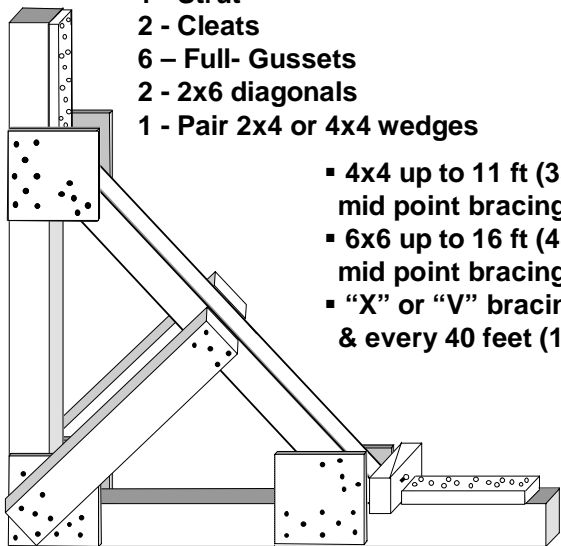

45 Degree Raker Strut Lengths

Long point to long point

Insertion Point		Strut Length	
Feet	Cm	Inches	Cm
8	244	136	345
9	274	153	389
10	300	170	432
11	335	187	475
12	366	204	518
13	396	221	561
14	427	238	605
15	457	255	648
16	488	272	691
17	518	289	734
18	549	306	777
19	579	323	820
20	610	240	863
21	640	357	907
22	671	374	950
23	701	391	993
24	732	408	1036

60 Degree Raker Strut Lengths

Long point to long point

Insertion Point		Strut Length	
Feet	Cm	Inches	Cm
8	244	112	284
9	274	126	320
10	300	140	356
11	335	154	391
12	366	168	427
13	396	182	462
14	427	196	498
15	457	210	533
16	488	224	569
17	518	238	605
18	549	252	640
19	579	266	676
20	610	280	711
21	640	294	747
22	671	308	782
23	701	322	818
24	732	336	853

Raker Shore Lacing and Bracing

Every 40 ft (13.5m) and each end

Insertion Point

4x4 < 8 ft (330cm)

6x6 < 16 ft (480cm)

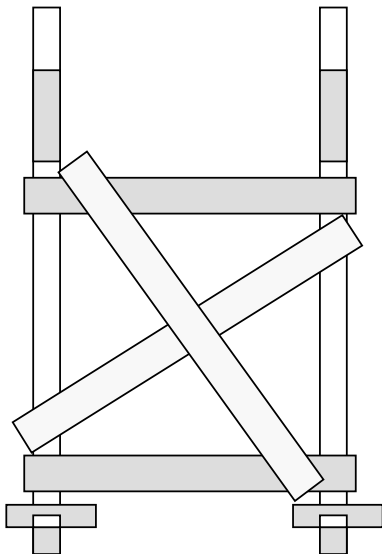

Insertion Point

4x4 > 8 ft (330cm)

6x6 > 16 ft (480cm)

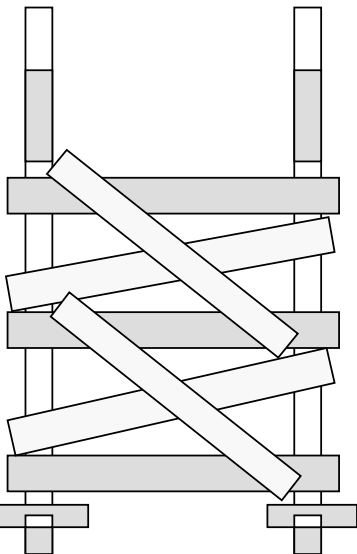

Sloped Floor Shore Perpendicular - Type I

- Used when slope is over 3 degrees (6 inches in 10 feet)
 - Pairs placed up to 8 ft (240cm)
 - Sloped floor/structure must be attached at top or bottom
 - 2x6 horizontal & diag. "X" bracing
 - $\frac{3}{4}$ " plywood with a min. width of 12" (30cm) and a max. length of 5 ft (152cm), may replace bracing on short side with a min. of 11 - 8d nails to each post
- 1 - Header
 - 2 - Posts
 - 2 - U Channels
 - 2 - 2x6 Diagonals
 - 1 - Horizontals
 - 2 - Half-gussets
 - 2 - U Channels
 - 2 - Pair 2x4 wedges
 - 2 - Sole plates

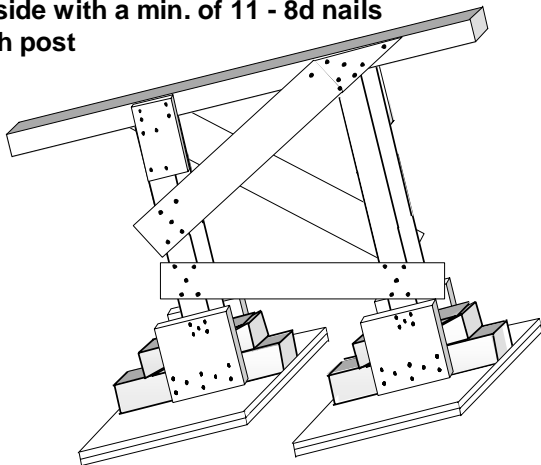

Sloped Floor Shore Perpendicular - Type II

- Used when slope is over 3 degrees (6 inches in 10 feet)
 - Slope pairs placed up to 8 ft (240cm)
 - 2x6 horizontal and diag. "X" bracing
 - Sloped floor/structure must be attached at top or bottom
 - $\frac{3}{4}$ " plywood with a min. width of 12" (30cm) and a max. length of 5 ft (152cm), may replace bracing on short side with a min. of 11 - 8d nails to each post
- | |
|---------------------|
| 1 - Header |
| 1 - Sole plate |
| 2 - Posts |
| 4 - Cleats |
| 2 - Half-gussets |
| 2 - 2x6 diagonals |
| 2 - Pair 2x4 wedges |

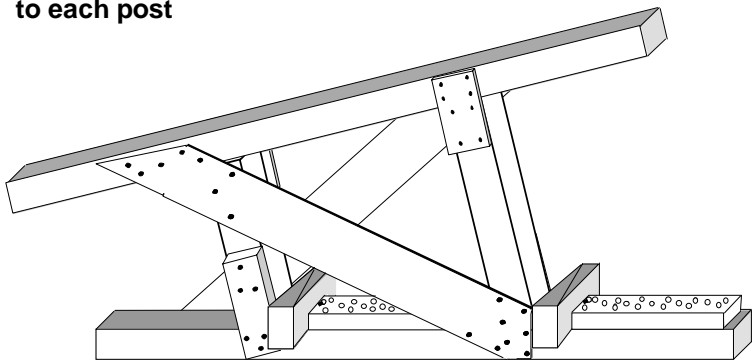

Sloped Floor Shore

Friction - Type III

- Used when slope is over 3 degrees (6 inches in 10 feet)
 - Pairs placed up to 8 feet (240cm) on center
 - Header must be attached to sloped surface over 5 degree slope
 - 2x6 horizontal & diag. "X" bracing
 - $\frac{3}{4}$ " plywood with a min. width of 12" (30cm) and a max. length of 5 ft (152cm), may replace bracing on short side with a min. of 11- 8d nails to each post
- | |
|---------------------|
| 1 - Header |
| 1 - Sole plate |
| 2 - Posts |
| 2 - Cleats |
| 4 - Half-gussets |
| 2 - 2x6 Diagonals |
| 2 - Pair 2x4 wedges |

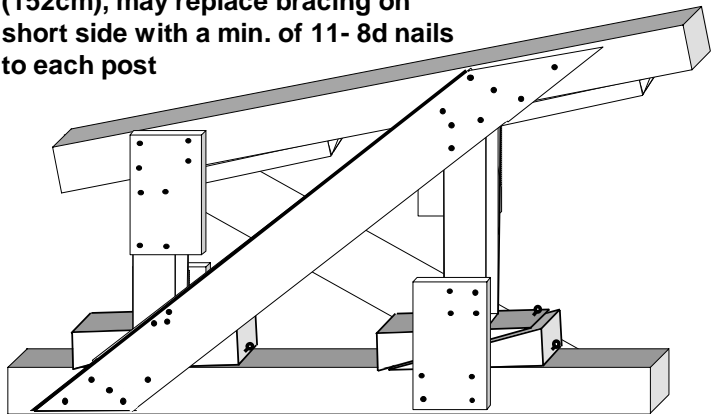

12 x 12"
(30x30cm)
5 and 8
8d nails

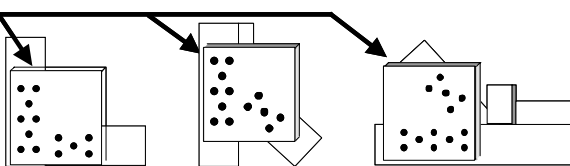

Raker, Full - Gusset Plate Nail Patterns

12" (30cm)
triangle
5 and 8
8d nails

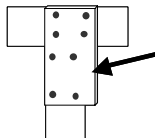
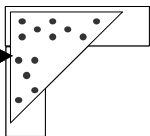

6 x 12"
(15x30cm)
4 and 4
8d nails

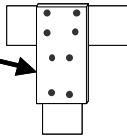

Triangle & Half- Gusset Plate Nail Patterns

12 x 12"
(30x30cm)
5 and 8
8d nails

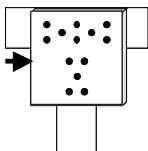

12 x 24"
(30x60cm)
5 - 8d to Posts
14 - 8d to Header

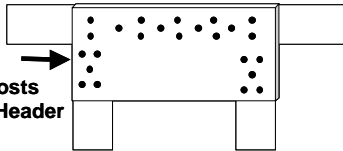

T and Dbl-T Nail Patterns

2x4, 3 - 16d nails

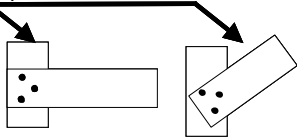

2x6, 5 - 16d nails

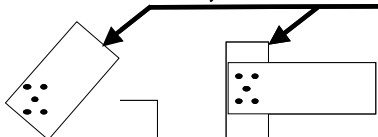

Lacing and Bracing Nail Patterns

Cleat Nail Patterns

2x4x24 (60cm) 14 - 16d nails
45 deg Raker

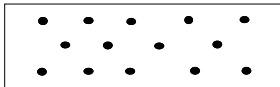

2x4x30 (75cm) 20 - 16d nails
60 deg Raker

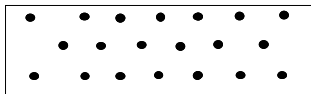

2x6x24 (60cm) 20 - 16d nails
45 deg Raker

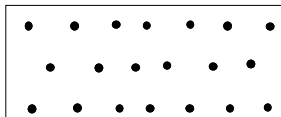

2x6x30 (75cm) 29 - 16d nails
60 deg Raker

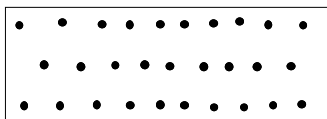

Split Sole Base Alternatives

(may also be used for Flying Raker)

U-Channel

4x4x18 (45cm)

12x12x3/4 (30x30cm) ea side

8 - 8d nails ea side

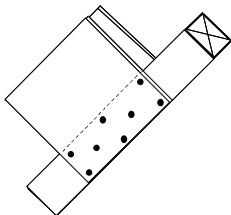

Trough

2x6x48 (120 cm) ea side

2x4x48 (120 cm)

7 - 16d nails ea side

2x4x18 (45cm) flush w/end

3 - 16d nails ea side



Trough with Sole Anchor

6x6x36 min (90cm)

may be continuous between Rakers

4 - 1" Pickets into Soil at Sole Anch

(2 - 1" Pickets into Paving)

1 - Picket ea side Trough

(1"x 48" (120cm) Pickets)

Pair 2x4 or 4x4 wedges

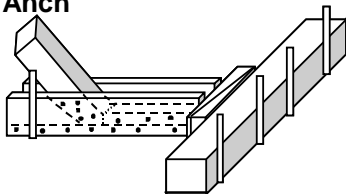

Unit Activity Log ICS 214	1. Incident Name:	2. Date:	3. Time:
4. Rescue Squad:	5. Leader:	6. Operational Period:	
7. Rescue Squad Roster			
RS 1 (ASL):			
RS 2:			
RS 3:			
RS 4:			
RS 5:			
HazMat:			
Medic:			
8. Activity Log (cont. on reverse)			
Time:	Major Events:		

Unit Activity Log ICS 214	1. Incident Name:	2. Date:	3. Time:
4. Rescue Squad:	5. Leader:	6. Operational Period:	
7. Rescue Squad Roster			
RS 1 (ASL):			
RS 2:			
RS 3:			
RS 4:			
RS 5:			
HazMat:			
Medic:			
8. Activity Log (cont. on reverse)			
Time:	Major Events:		

Unit Activity Log ICS 214	1. Incident Name:	2. Date:	3. Time:
4. Rescue Squad:	5. Leader:	6. Operational Period:	
7. Rescue Squad Roster			
RS 1 (ASL):			
RS 2:			
RS 3:			
RS 4:			
RS 5:			
HazMat:			
Medic:			
8. Activity Log (cont. on reverse)			
Time:	Major Events:		

Unit Activity Log ICS 214	1. Incident Name:	2. Date:	3. Time:
4. Rescue Squad:	5. Leader:	6. Operational Period:	
7. Rescue Squad Roster			
RS 1 (ASL):			
RS 2:			
RS 3:			
RS 4:			
RS 5:			
HazMat:			
Medic:			
8. Activity Log (cont. on reverse)			
Time:	Major Events:		

Unit Activity Log ICS 214	1. Incident Name:	2. Date:	3. Time:
4. Rescue Squad:	5. Leader:	6. Operational Period:	
7. Rescue Squad Roster			
RS 1 (ASL):			
RS 2:			
RS 3:			
RS 4:			
RS 5:			
HazMat:			
Medic:			
8. Activity Log (cont. on reverse)			
Time:	Major Events:		

Time:	Major Events:

Unit Activity Log ICS 214	1. Incident Name:	2. Date:	3. Time:
4. Rescue Squad:	5. Leader:	6. Operational Period:	
7. Rescue Squad Roster			
RS 1 (ASL):			
RS 2:			
RS 3:			
RS 4:			
RS 5:			
HazMat:			
Medic:			
8. Activity Log (cont. on reverse)			
Time:	Major Events:		

Time:	Major Events:

Unit Activity Log ICS 214	1. Incident Name:	2. Date:	3. Time:
4. Rescue Squad:	5. Leader:	6. Operational Period:	
7. Rescue Squad Roster			
RS 1 (ASL):			
RS 2:			
RS 3:			
RS 4:			
RS 5:			
HazMat:			
Medic:			
8. Activity Log (cont. on reverse)			
Time:	Major Events:		

Time:	Major Events:

Unit Activity Log ICS 214	1. Incident Name:	2. Date:	3. Time:
4. Rescue Squad:	5. Leader:	6. Operational Period:	
7. Rescue Squad Roster			
RS 1 (ASL):			
RS 2:			
RS 3:			
RS 4:			
RS 5:			
HazMat:			
Medic:			
8. Activity Log (cont. on reverse)			
Time:	Major Events:		

Time:	Major Events:

Unit Activity Log ICS 214	1. Incident Name:	2. Date:	3. Time:
4. Rescue Squad:	5. Leader:	6. Operational Period:	
7. Rescue Squad Roster			
RS 1 (ASL):			
RS 2:			
RS 3:			
RS 4:			
RS 5:			
HazMat:			
Medic:			
8. Activity Log (cont. on reverse)			
Time:	Major Events:		

Unit Activity Log ICS 214	1. Incident Name:	2. Date:	3. Time:
4. Rescue Squad:	5. Leader:	6. Operational Period:	
7. Rescue Squad Roster			
RS 1 (ASL):			
RS 2:			
RS 3:			
RS 4:			
RS 5:			
HazMat:			
Medic:			
8. Activity Log (cont. on reverse)			
Time:	Major Events:		

Unit Activity Log ICS 214	1. Incident Name:	2. Date:	3. Time:
4. Rescue Squad:	5. Leader:	6. Operational Period:	
7. Rescue Squad Roster			
RS 1 (ASL):			
RS 2:			
RS 3:			
RS 4:			
RS 5:			
HazMat:			
Medic:			
8. Activity Log (cont. on reverse)			
Time:	Major Events:		

Unit Activity Log ICS 214	1. Incident Name:	2. Date:	3. Time:
4. Rescue Squad:	5. Leader:	6. Operational Period:	
7. Rescue Squad Roster			
RS 1 (ASL):			
RS 2:			
RS 3:			
RS 4:			
RS 5:			
HazMat:			
Medic:			
8. Activity Log (cont. on reverse)			
Time:	Major Events:		

Signs and Symptoms of Nerve Agent Exposure

▪ MILD

- Headache
 - Blurred vision/pinpoint pupils
 - Tight chest
 - Excessive sweating
 - Tearing
 - Salivation
 - Unexplained runny nose
-

▪ MODERATELY SEVERE

- Severe chest tightness
 - Diarrhea (rare)
-

▪ VERY SEVERE

- Bluish discoloration of skin
 - Respiratory failure
 - Coma
 - Unconscious
 - Seizures
-

“SLUDGEM”

- **Salivation**
 - **Lacrimation**
 - **Urination**
 - **Defecation**
 - **GI upset (cramps)**
 - **Emesis**
 - **Muscular Twitching**
-

Treatment For Exposure

- Must have no doubt of exposure and the need for treatment.
- Use these drugs only on symptomatic, contaminated personnel
- Depending on severity of symptoms, immediately administer 1 atropine auto-injector, followed by 1 “2-PAM Cl” auto-injector
- If signs and symptoms still exist after 5–10 mins, repeat injections
- If signs and symptoms still exist after additional 10 mins, repeat injections for third time
- If signs and symptoms remain after third set of injections, do not give any more antidotes but seek immediate medical help

If Severe Signs and Symptoms are Present:

- All three auto-injector kits (atropine and “2-PAM Cl”) should be administered in rapid succession
- If patient is actively seizing, Valium (10mg) should be administered

Mark I Kit Directions for Use

Partner Antidote Administration

- Antidote administration primarily responsibility of your partner
- Antidote self-administration is the exception (to be accomplished only under extraordinary circumstances)!
- Agent exposure does not necessarily mandate antidote administration!
- Remove safety cap (yellow on atropine; gray on “2-PAM Cl”). Mark I kit clip holds the safety caps; may not notice if using Mark I kits. Do not touch colored end of injector after removing cap; injector can and will function into fingers or hand if any pressure applied to this end of injector
- Hold injector like a pen. Place colored end (green on atropine, black on “2-PAM Cl”) on thickest part of thigh and press hard until injector functions
- Hold firmly in place for ten seconds, then remove. Massage the area of injection

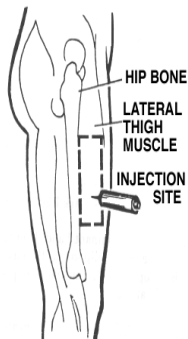
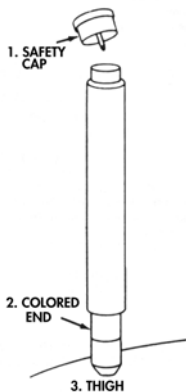

General Cordon Markings

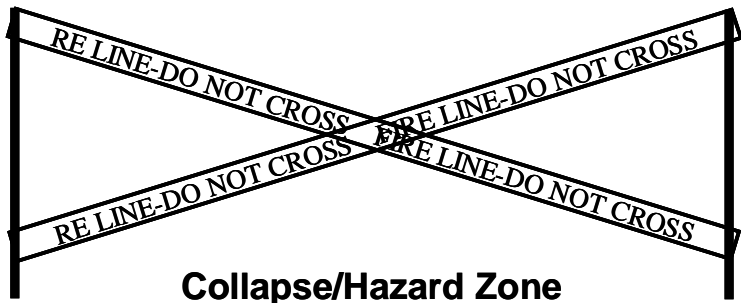
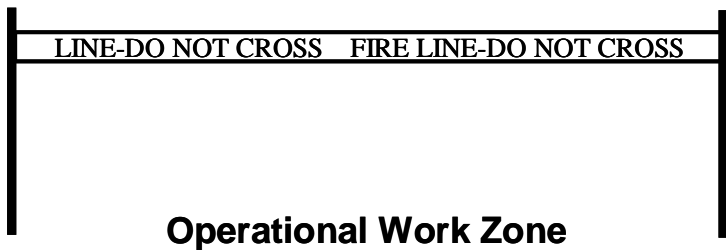

Evacuation Signals

- **Evacuate**
 - 3 Short blasts
 - (*Continually until all out*)
 - (1 Second each)

- **Cease Operations**
 - 1 Long blast
 - (3 Seconds)

- **Resume Operations**
 - 1 Long and 1 short blast

Note if different: