

# SURVIVAL SHELTERS

## CONSTRUCTION MANUAL

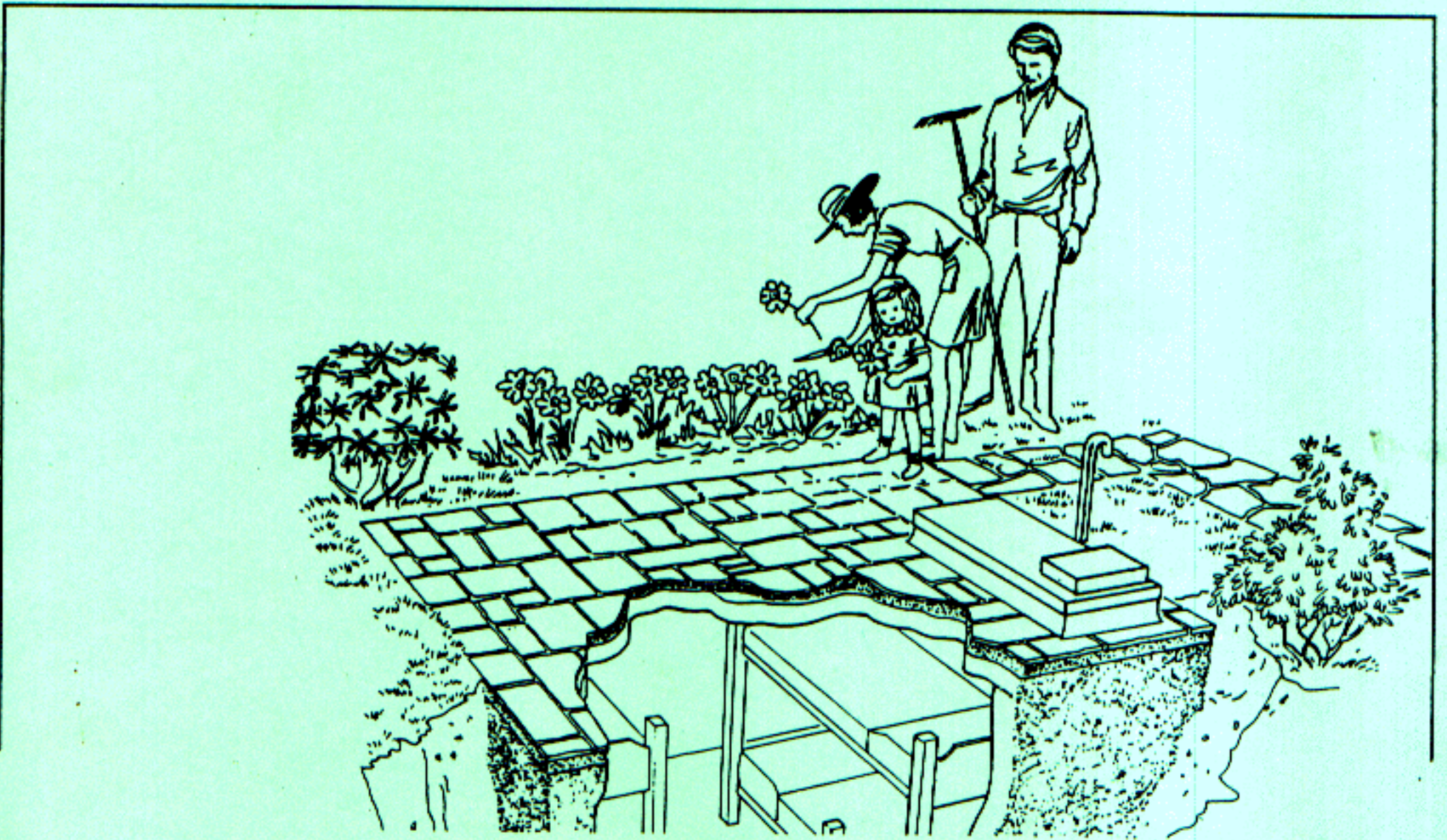

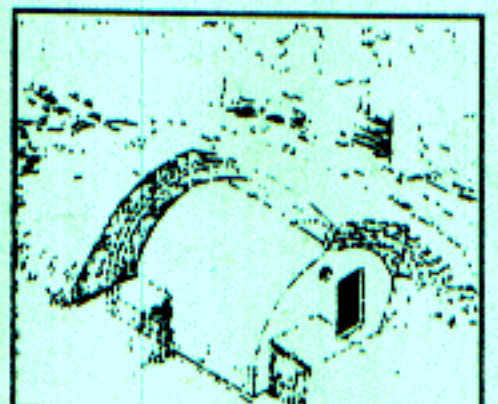
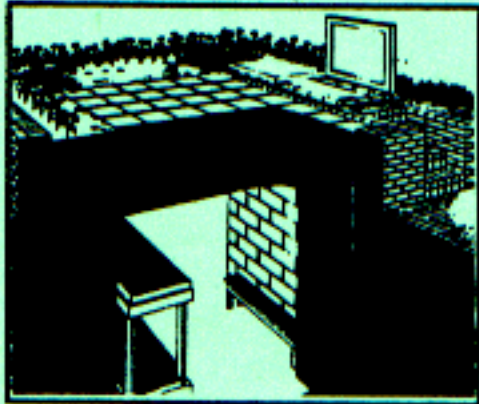
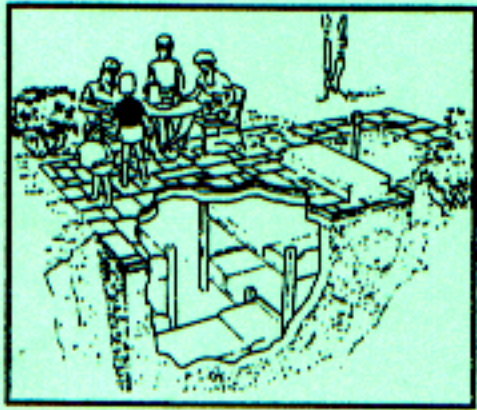

# CONSTRUCTION of SURVIVAL SHELTERS

It's not just crazy talk anymore, Anarchism is here! The insane foreign policies of this government have brought terrorists to America with their bombs! The Los Angeles riots were only a small sample of what is to come if the comforts we now enjoy are removed. Your only choice must be to plan ahead for the inevitable. You will see 11 different, **totally complete plans**, material lists, and instructions ranging from easy to construct basement blast shelters, to totally comfortable underground shelters that look like pleasant patios or gardens. M&M engineering has finally released it's trouble free survival shelter plans that you can be *comfortable living in and comfortable looking at from the outside*. Absolutely essential survival preparation for pre New World Order society (mass confiscations of property and freedoms) and in the aftermath, the reestablishment of Socialist Governmental Control. Think for a moment, your guns, food, precious metals, and medicine are planted in burial tubes in the ground and that's great for the short term but wouldn't it be better to construct a secret shelter where your lifesaving supplies will be safe for you to inspect, repair, and replace whenever **YOU** want to.

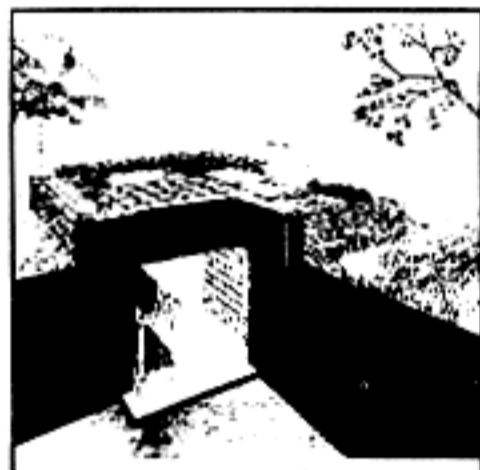

## TABLE OF CONTENTS

### CHAPTER

### PAGE

- |  |            |
|--|------------|
| <b>1. ABOVE GROUND FALLOUT SHELTERS</b>      | <b>5</b>   |
| <b>2. MILITARY SHELTERS</b>                  | <b>13</b>  |
| <b>3. BELOW GROUND SHELTERS</b>              | <b>18</b>  |
| <b>4. BELOW GROUND FALLOUT SHELTER</b>       | <b>66</b>  |
| <b>5. BELOW GROUND BLAST SHELTER</b>         | <b>74</b>  |
| <b>6. BASEMENT FALLOUT SHELTER I</b>         | <b>85</b>  |
| <b>7. BASEMENT FALLOUT SHELTER II</b>        | <b>93</b>  |
| <b>8. BASEMENT FALLOUT SHELTER III</b>       | <b>99</b>  |
| <b>9. BASEMENT FALLOUT SHELTER MULTI-USE</b> | <b>103</b> |
| <b>10. BASEMENT FALLOUT SHELTER PREFAB</b>   | <b>108</b> |
| <b>11. BASEMENT FALLOUT SHELTER PREFAB</b>   | <b>113</b> |
| <b>12. BURIAL VAULTS</b>                     | <b>120</b> |



The purpose of this construction manual is

fold in it's scope

① To provide you with professionally designed survival shelters that can be built under "normal" pretenses so as to arouse as *little concern* of your local zoning board, state building administration, federal agencies to numerous to list in this small manual, and all your neighbors.

It stands to reason that if you file papers with the zoning board that you are about to build a "blast shelter", you would first: Be the talk of your town, second: You would draw a crowd of on lookers who want to see first hand how you are building a underground "blast shelter". Third: The government at all levels will record and probably monitor your activities for the rest of your life! and fourth: In the unlikely event that what the doom sayers are telling us is true, that we are about to experience a world wide shit storm of anarchy, your building records are public documents! If *anyone* knows you built a nuclear blast shelter, then in times of need they will come in mass to you in your shelter and after their failed attempts to persuade you to feed and house them they would surely become resentful of your "**GREED and SELFISHNESS**" with "**THEIR**" food and medicine, simply put, you have given your friendly neighbors a target, and they will eventually breach whatever security measures you may have devised to get at your food, medicine and weapons.

Having served my community on the town Zoning board I can give just a few suggestions that would arouse little or no suspicion to the submission of your plans and filing your applications to build your new underground "pool filter room" or a state of the art environmental safe "septic system" or the most environmentally safe "heating oil storage tank" available, (but we know your building you're survival shelter). If you live in a rural setting like I do, hire distant outside contractors to perform the work as quickly and quietly as possible, pay cash with no name or receipt necessary, and tell no one.



②. The second reason is simple TO ALLOW OUR CONSTITUTION TO SURVIVE

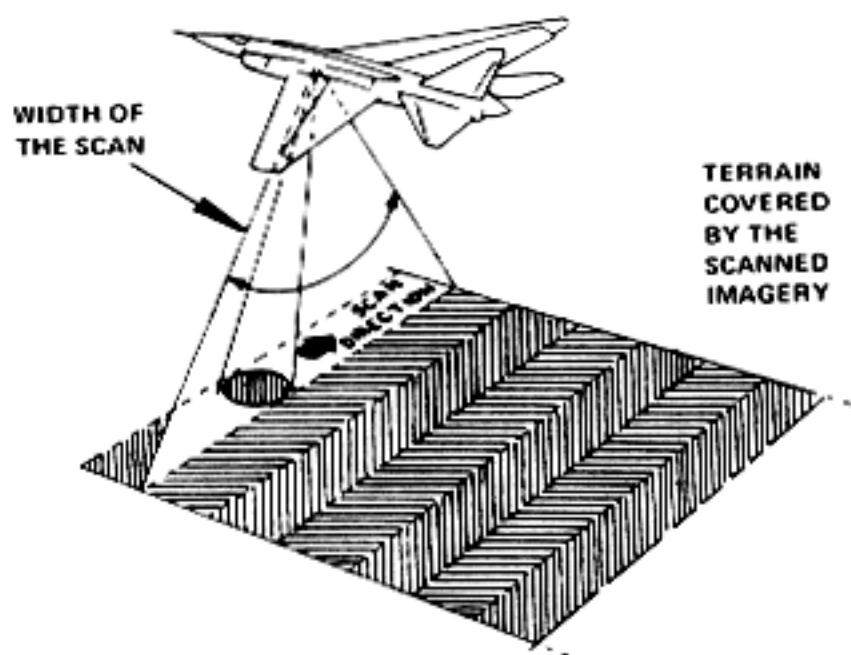

**CAN YOU BE DETECTED IN YOUR UNDERGROUND SHELTER?**

The world learned in Waco that this and many other governments can and do look for survival shelters! England actually participated in Waco with their high tech Penetrating Radar and infrared. News papers in London revelled that reliable detection to depths of 20 Feet . Infrared and gas spectrum analysis detection can also be integrated into their data for a near 100% detection, more on deception and concealment later in my manual.

## TUNNELS

Tunnels are not frequently integrated into a survival shelter due to the time, effort, and cost involved. However they can mean your success against offensive actions on your shelter or at least your successful escape. Soil composition, water table, terrain, and cost will control your decisions to build a escape tunnel or tunnel network, but you really should consider one escape route as a back up in the event of detection. Specifications for tunnel depth of 30 feet are given in military FM manuals along with a recommended 3 1/2 feet width and a height of 5 to 6 1/2 feet are recommended for tunnels not using timbers or support. We simply don't need a tunnel that is thirty feet below the surface it is far to costly and diggings would progress at best rates using unlimited manpower 25 feet a day (Test conducted by the U.S. Army).

There are always under road way culvert drain pipes to consider for cheap easy tunnels. I would recommend the Corrugated PVC plastic culvert drain pipe, this indestructible tubing comes in sizes ranging from 4 inches inside diameter to 4 feet inside diameter. This tubing is flexible so you can twist and bend it so as not to have a straight tunnel and can be installed in a ditch dug away from your shelter and covered over. They come in 20 foot sections with joints of all kind to connect and bend, this plastic tubing is totally waterproof, easy to keep clean and easy to cut. Your tunnel doesn't have to be super long, but it is important you plan ahead to place shrubs or buildings between your survival shelter and your exit hatch to allow a clean escape without being seen. Try to slant your tubing so drainage will move away from your shelter incase water becomes a problem or in the unlikely event your tunnel hatch is discovered and explosive charges like hand grenades or poison gases are used against you & I will give one last important suggestion, install a air tight hatch on your tunnel at the shelter side entrance. If your enemy drops a chemical grenade (very commonly used) into your tunnel and you can't stop the gas from entering your main shelter you will die within seconds of your first breath. On the other hand if your security alarm goes off telling you someone has opened the secret outside hatch, you could pop a rodent control smoke grenade (available at most any farm supply and feed store) into your tunnel and close your air tight hatch guaranteeing no one will enter your tunnel for at least a couple of days. In fact they will probably have to leave the immediate area, I guarantee this stuff is bad and shouldn't be toyed with!!

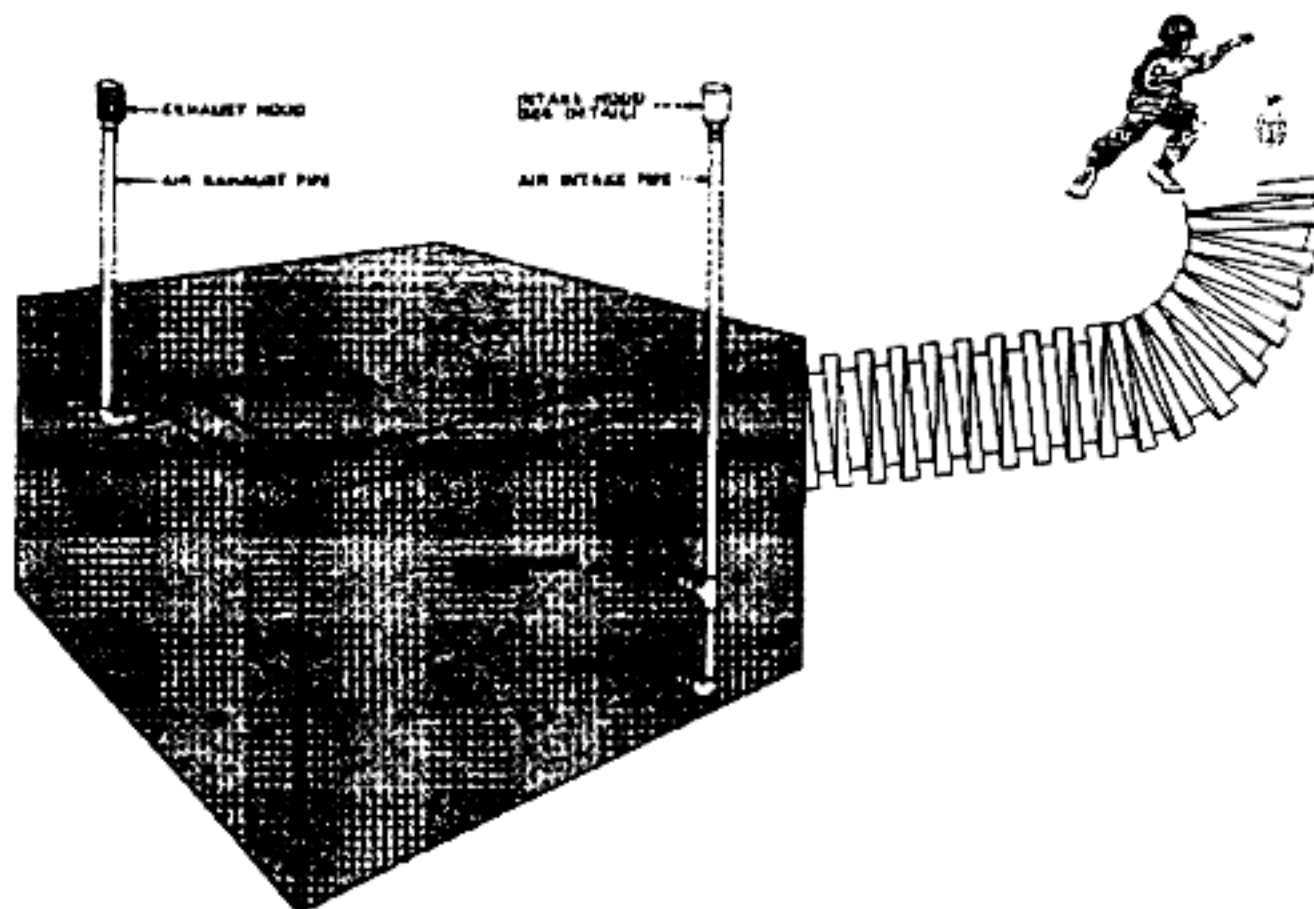

*Slanting your exit tunnel toward your shelter like in the left picture will allow anything and everything to roll right into your shelter.*



# CHAPTER 1

---

## ABOVE GROUND HOME FALLOUT SHELTER

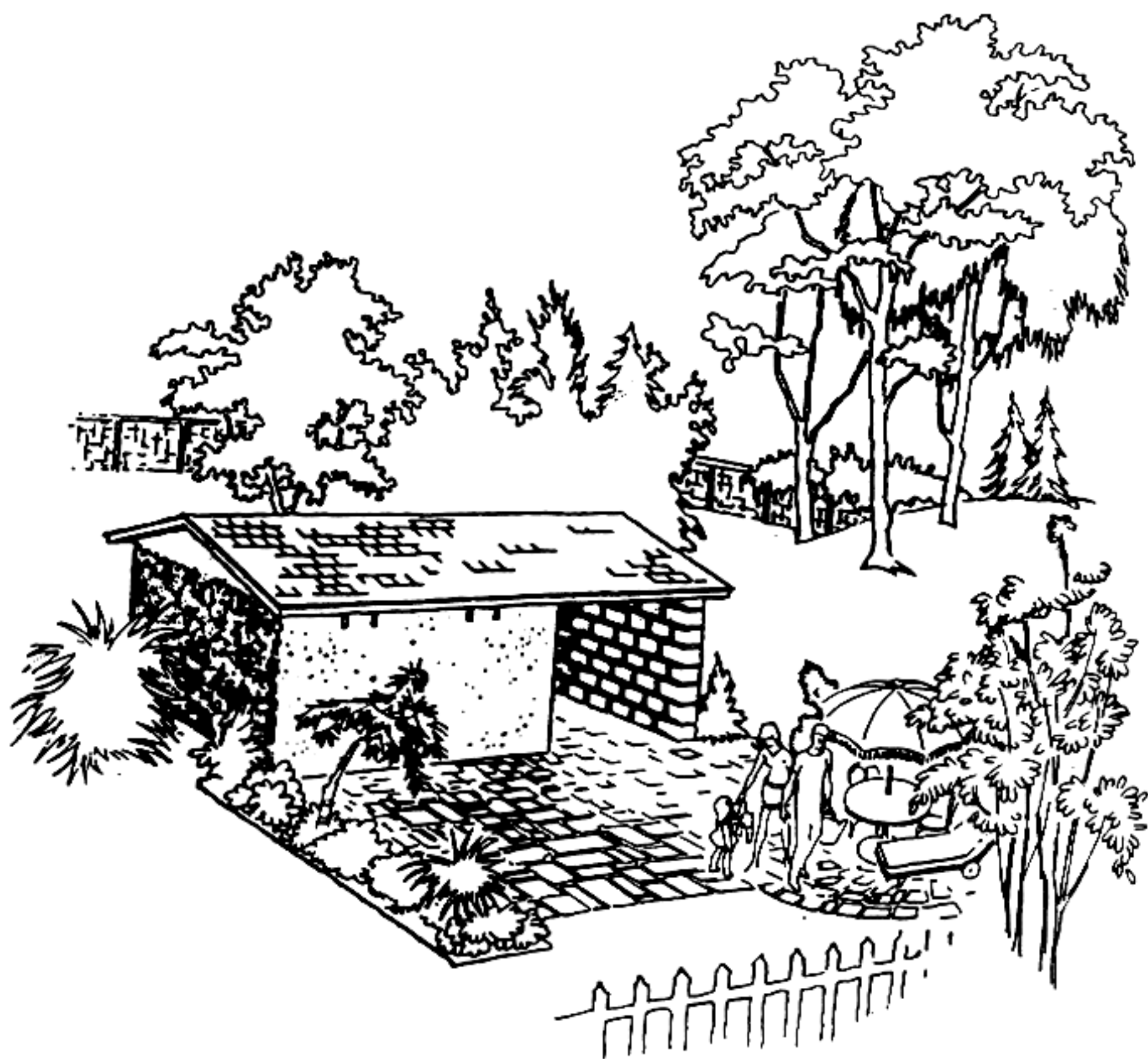



# POSSIBLE VARIATIONS

## FIRST ALTERNATE

Indicates windows in the "workshop" area. Solid blocks, equal to a thickness of 12 inches, should be available to fill these openings to provide adequate fallout protection. Windows sizes should be kept small. When using the shelter for protection against high winds, do not place the concrete blocks in the door way or windows.



## SECOND ALTERNATE

Shows the concrete block faced with brick. Use on thickness of 4-inch brick and two thickness of 8-inch concrete block to obtain the required weight per unit area. A perfect "residential equipment storage" building.

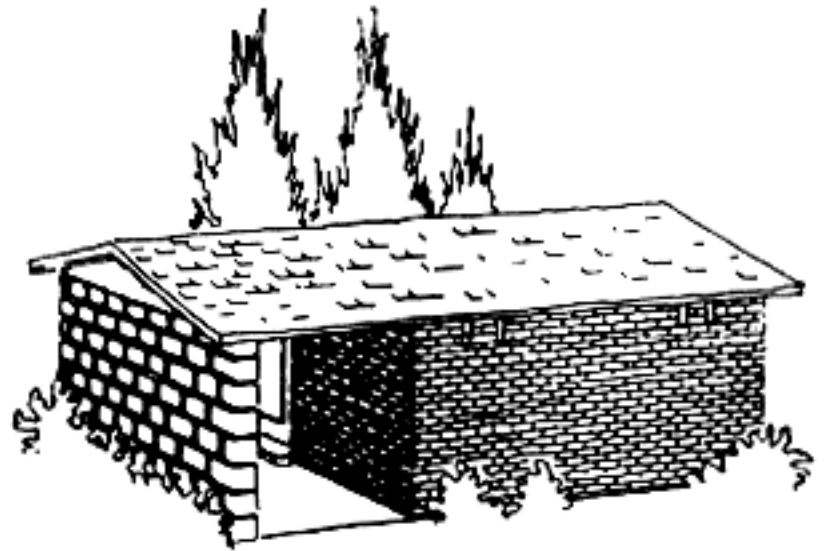

## THIRD ALTERNATE

Is to attach the "tool shed or workshop" to the house, with a covered area between. In this case, the facing materials should match the house for total concealment.



## FOURTH ALTERNATE

Could be to install built up roofing, asphalt, tar or other wearing surface on top of the concrete deck. This allows a beautiful and useful upper deck for "parties and family gatherings".

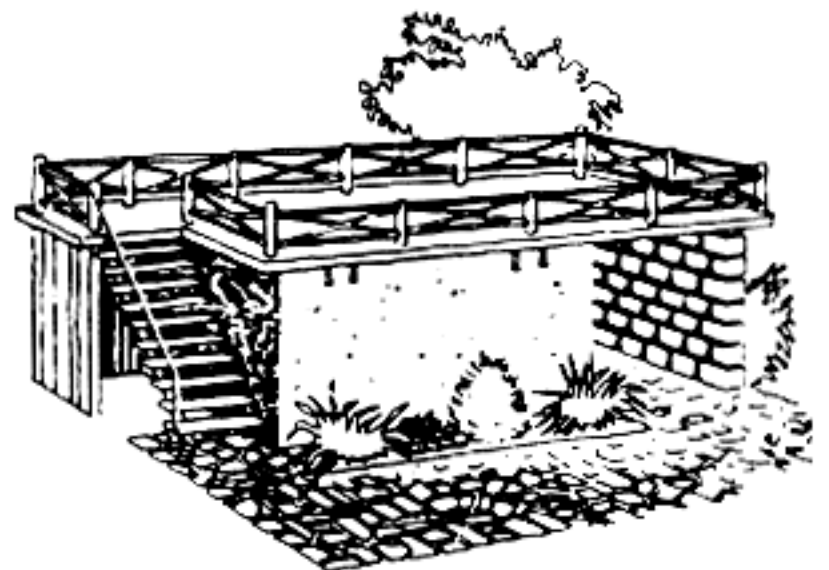



## GENERAL INFORMATION

This family shelter is intended for persons who prefer an above ground shelter or for some reason such as a high water table, cannot have a below ground shelter. In general, a below ground shelter is superior and more economical than an above ground shelter.

The shelter is designed to have a protection factor of at least 40, a level of protection established by the Federal Emergency Management Agency for public fallout shelters. It also provides significant protection from the effects of hurricanes, tomadoes, and earthquakes, and has sufficient space to shelter six adults.

The shelter can be built of two rows of concrete blocks, one 12" and one 8", filled with sand or grout, or of poured reinforced concrete. Windows have been omitted; therefore, electric lights are recommended for day to day use.

The details and construction methods are considered typical. If materials other than shown are delegated, for example, concrete block faced with brick - care should be taken to provide at least the same weight of materials pre square foot; 185 lb. per sq. ft. in the 4 walls and 100 lb. per sq. ft. in the roof. The wood frame roof over the reinforced concrete ceiling probably would be blown off by extremely high winds such as caused by a blast wave tomado. However, the wood frame roof is intended primarily for appearance and concealment, the concrete ceiling provides the protection. When using the shelter for protection against high winds DO NOT place the concrete blocks in the doorway or windows.

This structure has been designed for areas where frost does not penetrate the ground more than 20 inches. If 20 inches is not sufficient depth for footing, one or two additional courses of concrete blocks may be used to lower the footings. Average soil bearing pressure is 1,500 lb. pre sq. ft. *Most soils can be assumed to support this pressure without special testing or investigation.*

The baffle wall outside the entrance to the shelter is extended out 7'-4" to allow storage of lawn equipment such as wheel barrows and lawn mowers. If additional space is desired, extend this dimension.

Before starting to build the shelter, make certain that the plan conforms to the local building code. Obtain a building permit if required. If the shelter is to be built by a contractor, engage a reliable firm that offers protection from any liability or other claims arising from its construction.



**STEEL MASTER** Produces a wide assortment of sizes and accessories (Ventilators, lights, doors, etc.). These are even stronger than the quanset huts used by U.S. troops in the pacific during WW-II. They can be assembled near by then trucked to your waiting site and "DROPPED IN"! Yes these units are designed so well that you can easily build one "yourself"!



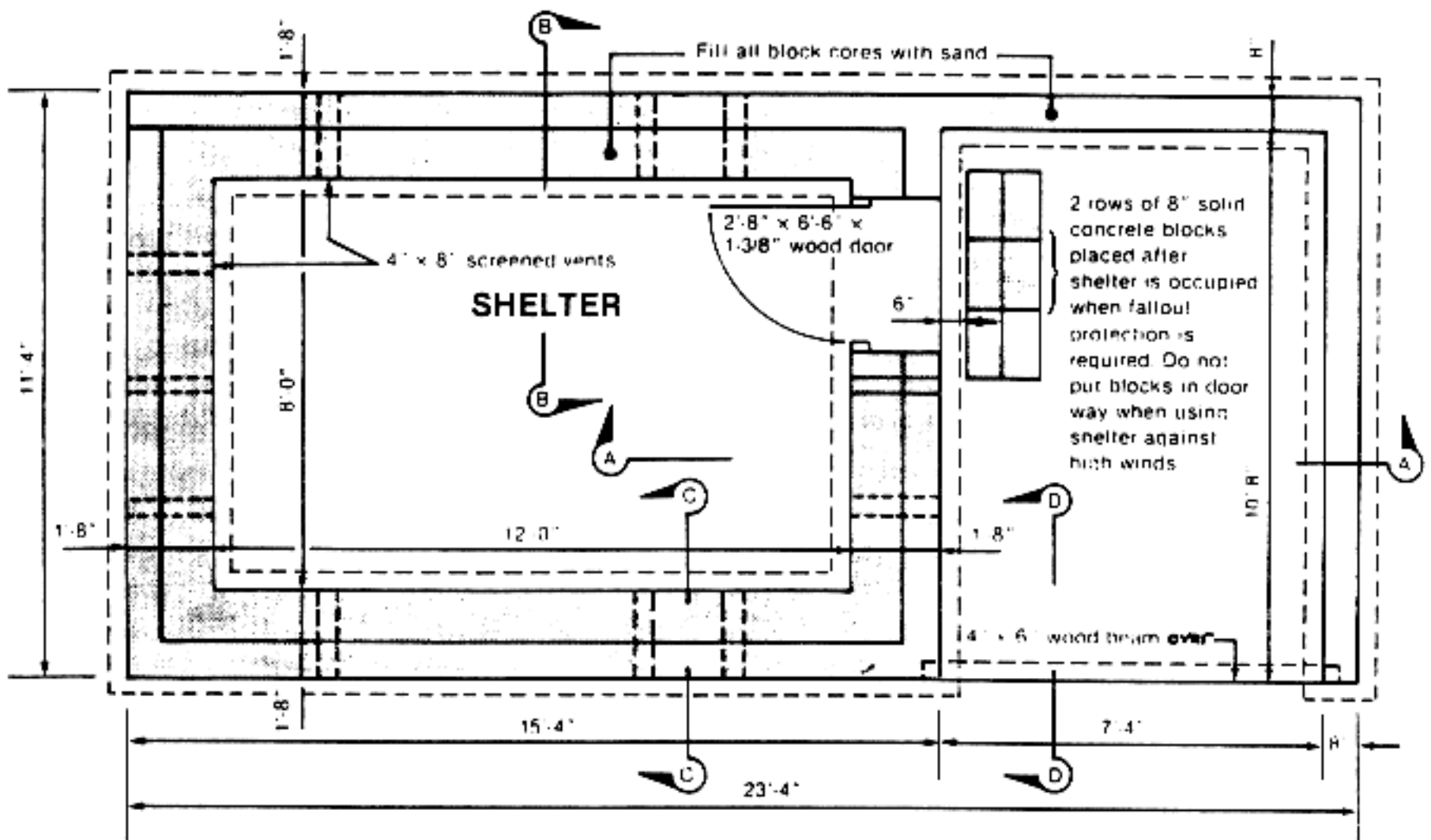

**PLAN**

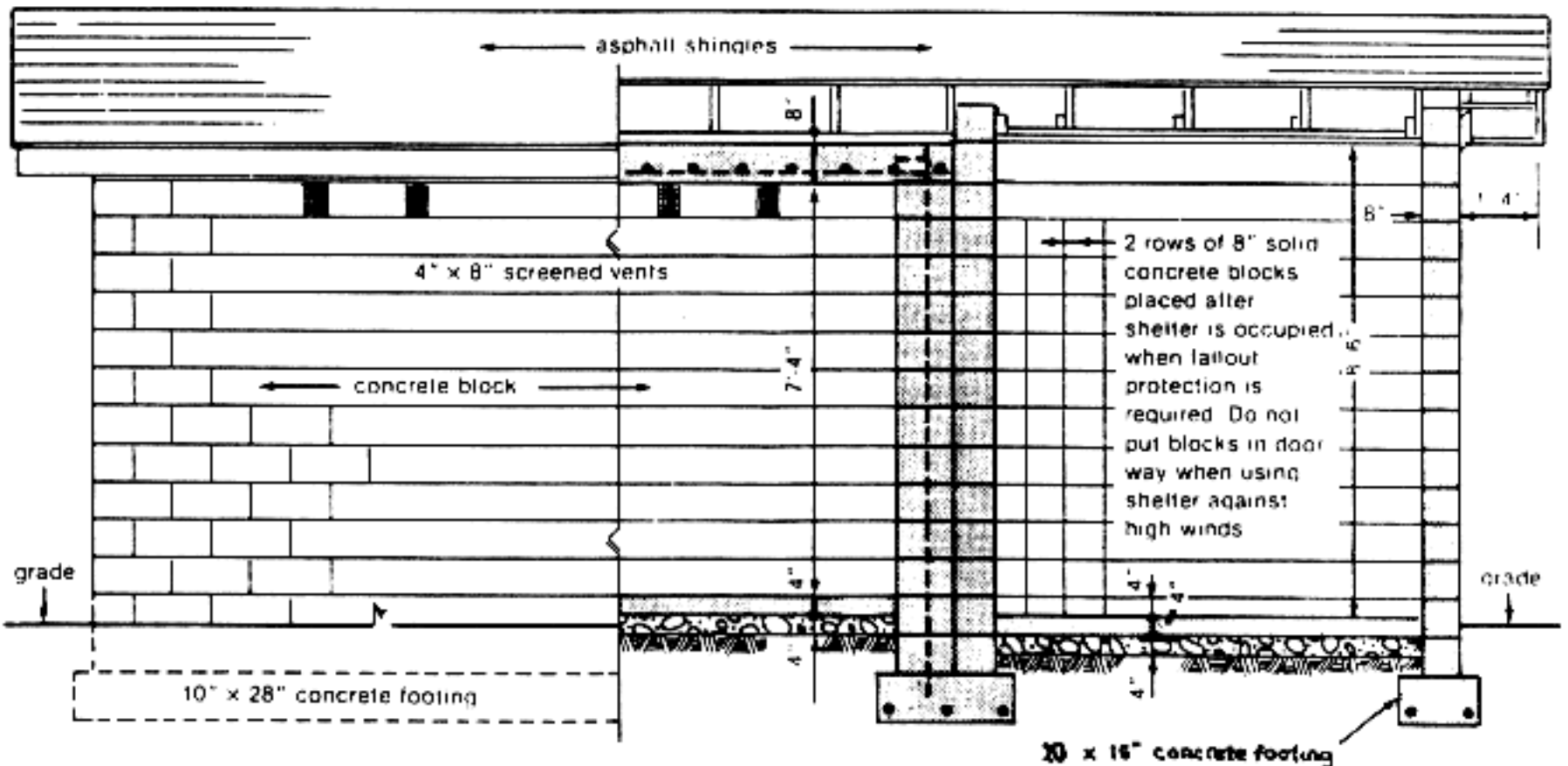

**ELEVATION**

**SECTION A-A**



### GUIDE TO CONTRACTORS AND SPECIFICATIONS

It is generally advisable to have a written contract with your contractor as well as specifications to supplement the drawing. A widely used and convent contract form for construction of this size is AIA Document A107, "Abbreviated Form of Agreement Between Owner and Contractor for Construction Project of Limited scope where the Basis of Payment is a Stipulated Sum," which is available from the American Institute of Architects, 1735 New York Ave., N.W., Washington, D.C. 20006. It would be impractical to write a specification to suit every local condition; however, the following summary of generally accepted construction materials and practices is a useful guide for the "Do It Yourselfer":

#### CONCRETE

For details of concrete construction, follow "Building Code Requirements for Reinforced Concrete (ACI-318-83)." This publication can be obtained from the American Concrete Institute, Box 19150, Redford Station, Detroit, Michigan 48219.

#### DAMP-PROOFING

Dampproofing the bottom slab is necessary to make the room more comfortable in most areas. Any contractor will be accustomed to compacting gravel and applying a polyethylene vapor barrier course. In areas that regularly experience high humidity, the outside walls of the block or concrete should be treated with a colorless type of protective coating material which is readily available at building supply stores. In areas of very low humidity, dampproofing might be omitted.

#### VENTILATION

Ventilation is obtained by natural convection. Air will enter the doorway and be exhausted through the holes at the ceiling. If a roof exhaust ventilation system is desired, it can be procured from commercial sources.

#### OPTIONS

①To accommodate additional persons, increase the shelter length 2'-6" for each two shelter spaces. **DO NOT** increase the 8'-0" width.

②Lighting and receptacles may be installed with electric service obtained from a separate residence circuit. A branch circuit breaker should be installed inside the shelter.

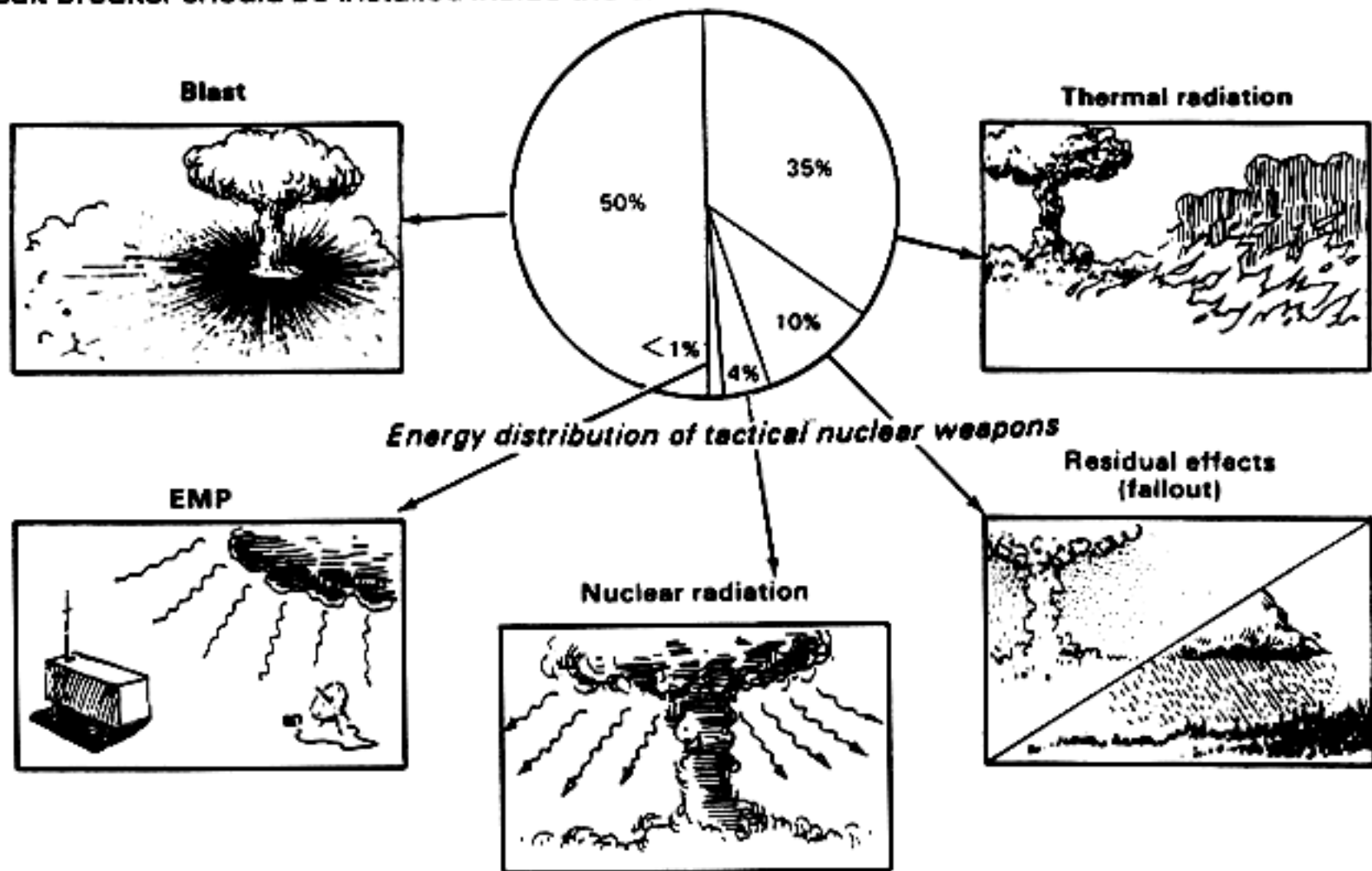

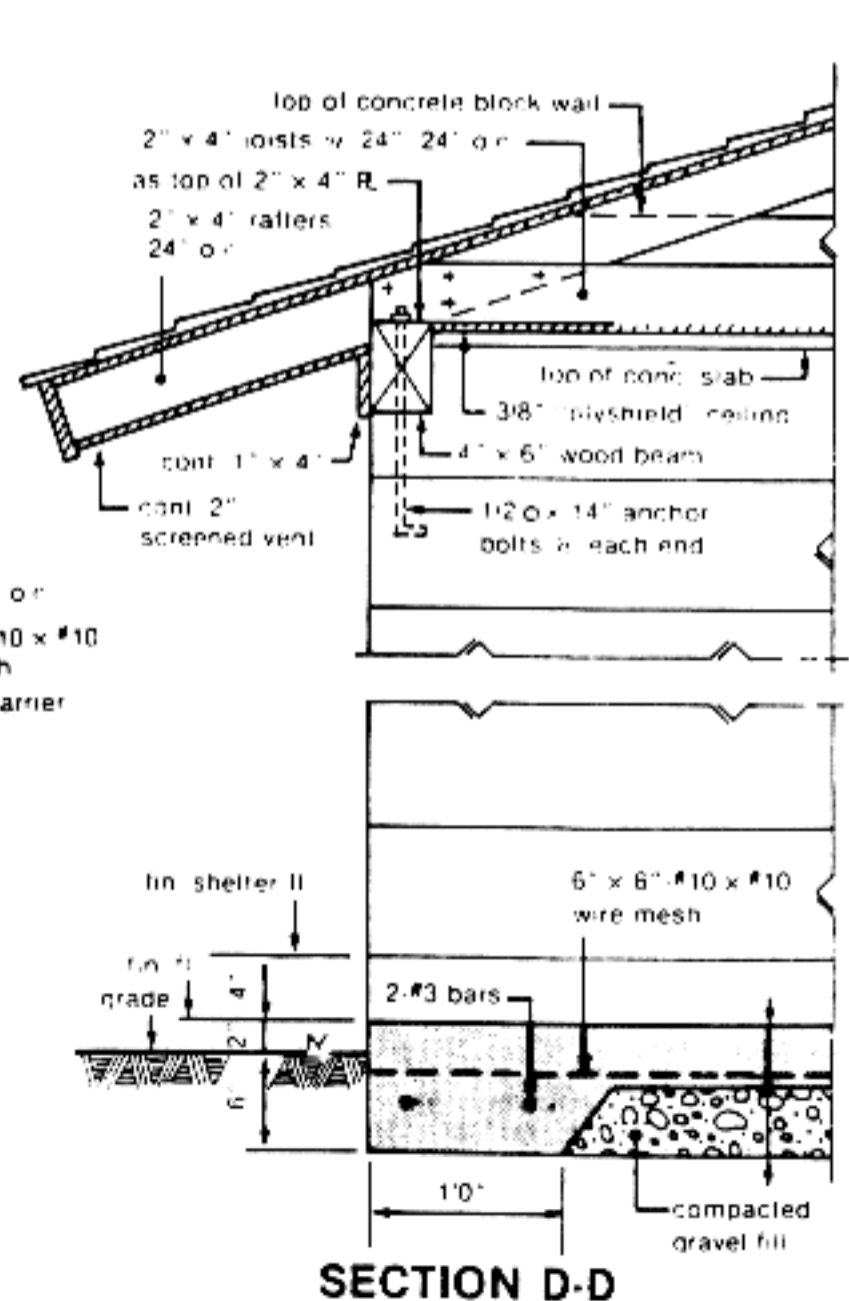
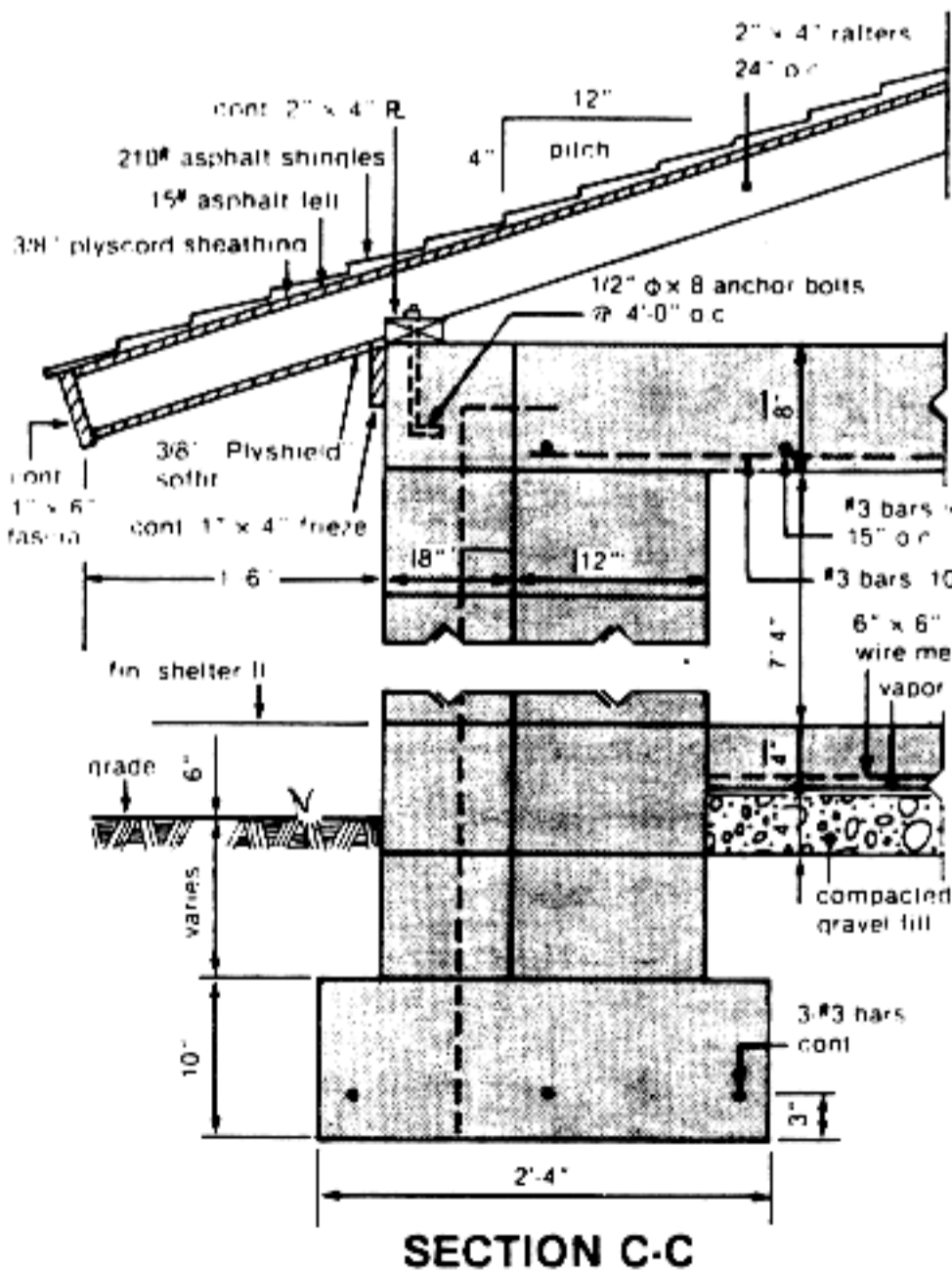
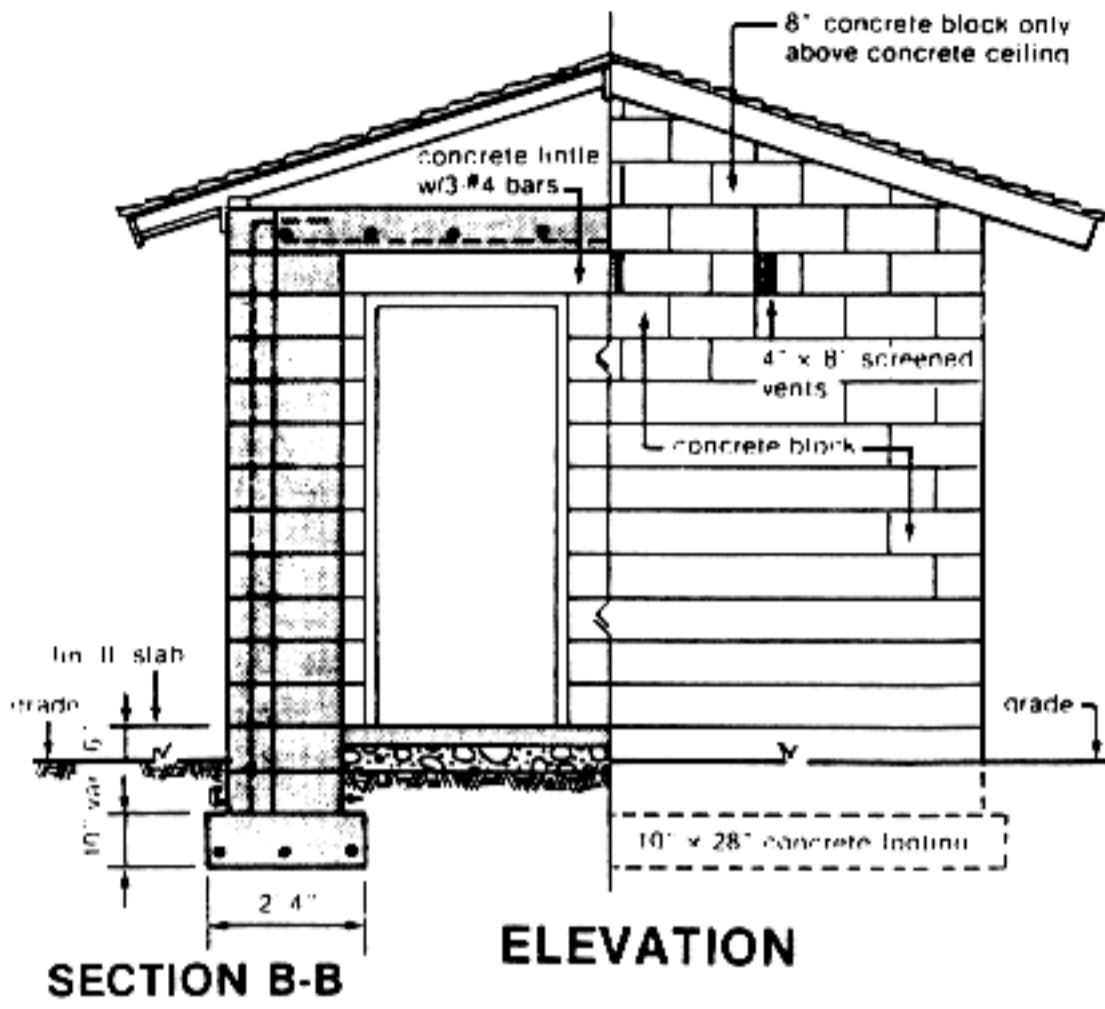



# LIST OF MATERIALS

## CONCRETE

Footings	4.5 cu. yds.
Floor	2.3 cu. yds.
Ceiling	3.4 cu. yds.
Footings #3 deformed bars	198 lin. ft

## STEEL REINFORCEING

Ceilings #3 deformed bars	257 lin. ft.
Walls #4 deformed bars for hurricane, tornado or earthquake resistance	300 lin. ft.
Tie Wire	100 lin. ft.

## MASONRY

8" x 8" x 16" Hollow standard weight concrete blocks	800
12" x 8" x 16" Hollow standard weight concrete blocks	430
8" X 8" X 16" Solid concrete blocks	66
Sand to fill block cores	12 1/2 yards

## MORTAR

Sand	1 1/2 yards
Portland cement	9 bags
Lime	2 bags

## LUMBER

2" x 4" 8'-0" Roof rafters	32
1' x 6" Ridge	26 lin.ft.
2" x 4" 12'-0" Ceiling Joists	5 pcs.
4" x 6" x 8'-0" Beam	1 pcs.
2" X 4" Bearing Plate	36 lin.ft.
4'-0" X 8' - 0" X 3/8" Plyscord Sheathing	13 sheets
4'-0" X 8' - 0" X 3/8" Plyshield Soffit & Ceiling	6 sheets
1" X 4" X 3/4"	48 lin. ft.
1" X 6" X 3/4	84 lin. ft.
3/4 - 1/4	24 lin. ft.
2' - 8" X 6' - 6" X 1 3/8" Solid Core Wood Door	1
2' - 8" X 6' - 6" X 5 1/2" Wood Jam	1

# LIST OF MATERIALS "MISCELLANEOUS"

15# Roofing felt	4 1/2 squares
210# Asphalt shingles	4 1/2 squares
1/2" dia. X 8" Anchor bolts	12
1/2" dia. X 14" Anchor bolts	2
Copper Screen	20 sq. ft.
6" X 6" - #10 X #10 Wire mesh	200 sq. ft.
Polyethylene vapor barrier (4 mils.)	200 sq. ft.
Gravel fill	2 1/2 yds.
4" Hinges W/screws	3
Lock set	1
16d Common nails	25 lbs.
8d Common nails	20 lbs.
6d Common nails	10 lbs.
8d Casing nails	5 lbs.
Exterior paint, primer	5 gallons.
Exterior paint, 2 coats	6 gallons.
Interior paint, primer	4 gallons.
Interior paint, 2 coats	5 gallons

## NOTE:

Provided horizontal joint reinforcement for 1' - 18" walls in every third course and metal cross ties at 2' - 0" o.c. in every alternate course.

If concrete is used in place of block, the walls of the shelter shall be 1' - 3" thick with #4 bars at 14" o.c. each way, each side.

The dimension from finished grade to bottom of footings is dependent upon the depth of frost and varies with geographic location. Consult with your local building code.

In areas subject to hurricanes, tornadoes, or earthquakes, walls shall be reinforced with #4 bars at 16" o.c. vertically. Place bars in block cells and then fill with grout. Lap bars between wall and footing dowels, and between wall and roof slab as illustrated.

The wood frame roof over the reinforced concrete ceiling probably would be blown off by extremely high winds such as caused by a blast wave or tornado. However, this roof is primarily intended for appearance and concealment; the concrete ceiling provides ample protection.

## **STRUCTURAL DESIGN DATA;**

**Steel = Grade 40**

**Concrete = 2,500 psi**

**Soil (minimum) = 1,500 pounds square foot**



# CHAPTER 2

## MILITARY SHELTERS ABOVE AND BELOW GROUND

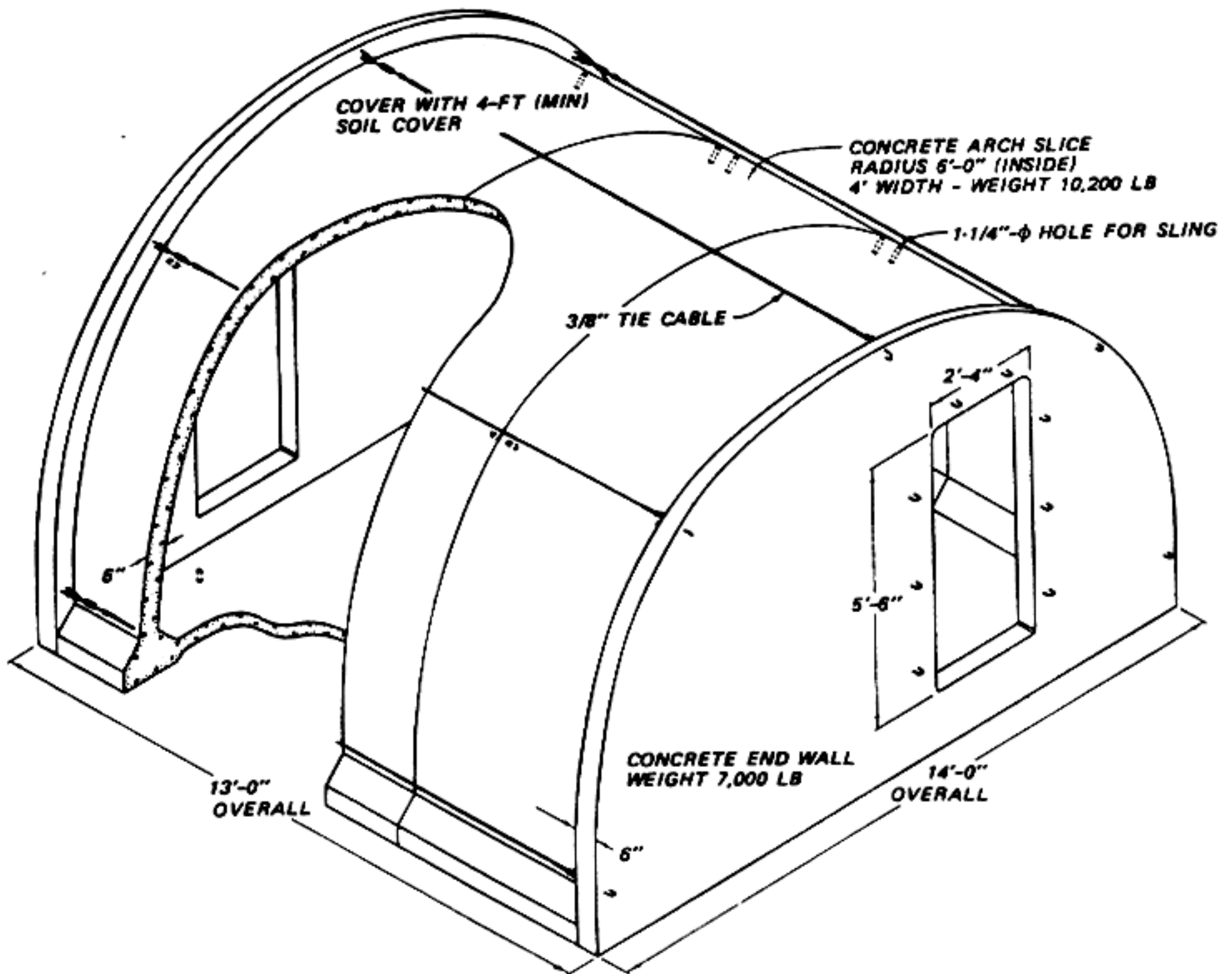

## CONCRETE ARCH SHELTER

We could not possibly cover survival shelters properly without taking advantage of our military (particularly the U.S. ARMY's) expertise. Here are two shelters that can be readily assembled with relatively low cost and supply a strong shelter in the shortest possible construction time. The first can be constructed on sight utilizing readily available materials. Advantages of this material and design choice rest in it's ability to be expanded without reengineering, simply add or subtract corrugated arch slice length or tube diameter to vary shelter capacity. With a little imagination you could reengineer the door and venting to allow underground burial with air intakes and exhaust, water and sewer, entrance and escape tunnel, etc. Although this units metallic material produces high electronic signature (more on detection later) it's strong, fast, low cost construction and most important, it's ability to be constructed off sight and trucked to the prepared area to be assembled in a very short time with limited man power.

① Above ground, uncovered, and exposed. Level sight and apply water barrier.

② Bury it in a mound at surface level as seen in example, placement near a steep hillside so as to blend into hillside terrain or near supply of soil, water barrier to be used below and above shelter.

③ Disguise it under ground level with a landscape of poison ivy and sharp thorn bushes to discourage human discovery (more later). Complete burial of shelter under at least 4 ft. of soil, not more than 8' Max. Water barrier to be used below and above.

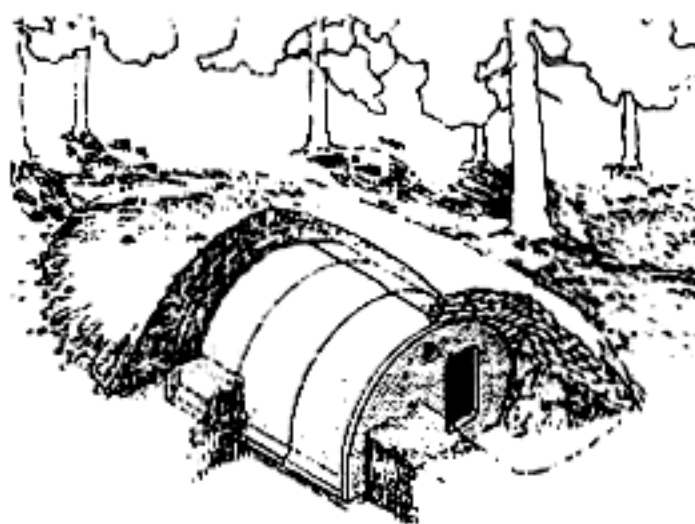

## ERECTING PROCEDURES

### 1. PREPARE SIGHT

2. Place waterproofing membrane on ground below shelter, polyethylene construction plastic 3 mils. or thicker or high grade of tar paper 15# or heavier.

3. Place arch section, can be assembled off sight and placed or on sight constructed.

4. Place rear end wall and brace temporarily, or (place tube upright and fill with concrete until a thickness of 8" recommended for burial).

5. Place and temporary brace front end wall.

6. Connect, tighten, & tie cables from end wall to end wall to secure, seal air gaps using silicon sealer or foam.

7. Place and connect entrance way specific to your choice of sight placement, Recommended air, water, communications, electrical, entrance hatch, etc., be placed in the "front" wall. Cast proper tubing and connections directly into concrete wall.

8. Place waterproofing membrane over shelter and entrance way, tar and seal all outside connections, including tubing bolts and overlap areas.

9. Back fill shelter as required to your specific desired landscape design, if buried on surface or submerge into soil, waterproofing and standard construction procedures for your specific geographical area should be used.



**BAR SCHEDULE**

- FOR ALL TYPE "B" BARS -

DOUBLE DIMENSION SHOWN UNDER LENGTH IN LINEAL FT.

**GENERAL SPECIFICATIONS**

1. Concrete; Portland cement, sand & coarse aggregate 3/4" Max, mixed to proportions for 3000 PSI compressive strength in 28 days.

Concrete reinforcing steel; intermediate grade 40,000 PSI tensile strength.

Multi-plate pipe arch; 8 - gage corrugated steel, 6" X 2" corrugations, Galvanized.

Miscellaneous fasteners; grade as available.

2. Design loading; 8' earth cover at crown.

3. Ground water seepage; all exterior surfaces of shelter & entrance way must be covered with waterproofing membrane to prevent ground water seepage.

4. Floor; corrugated - steel floor provided, optional covering is recommended, (concrete, wood, foam insulation, etc.).

5. Occupancy; 12' X 12' basic shelter designed for 10 persons allowing one sleeping bunk for each person.

6. Transportability; arch section total weight 4300 lb., end wall 7900 lb.

**NOTE:**

Rebars marked W1 - W20 can be replaced W66 - 8' - 10" straight rebar & Rebars marked W23 - W28 can be replaced W6 - 19' - 10" straight rebar. After assembly top & bottom rebar mats cut rebar to fit arch curve & door opening, air tubes, electrical, communication, etc. openings.

**BILL OF MATERIALS**

12' X 12' SHELTER (GROUND Poured "EXPEDIENT" CONCRETE "NO FORMS")

Multi - plate pipe arch section-Commercially available or at scrap yards

Concrete—4 yards

Concrete reinforcing steel—75 - 20' bars

Cable assembly (see cable detail)-----5 ea.

Reinforced steel tie wire—roll

Waterproof membrane—size as needed

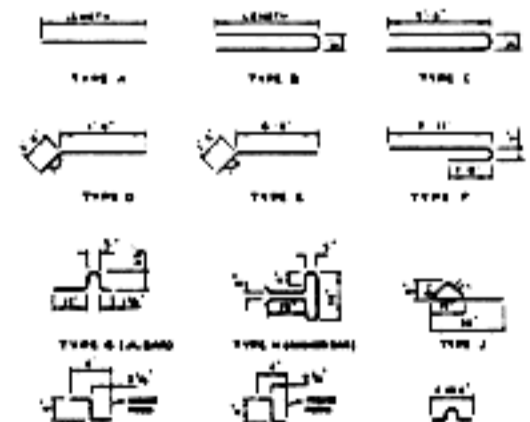

MARK	QUANTITY	SIZE	LENGTH	TYPE	LINEAL FT.
W	2	# 4	3' - 6"	B	14'
W2	2	# 4	4' - 4"	B	18'
W3	2	# 4	5' - 5"	B	22'
W4	2	# 4	6' - 3"	B	25'
W5	2	# 4	6' - 8"	B	27'
W6	2	# 4	7' - 2"	B	29'
W7	2	# 4	7' - 6"	B	30'
W8	2	# 4	7' - 9"	B	31'
W9	1	# 4	8' - 0"	B	16'
W10	1	# 4	8' - 2"	B	17'
W11	1	# 4	8' - 4"	B	17'
W12	1	# 4	8' - 6"	B	17'
W13	1	# 4	8' - 8"	B	18'
W14	1	# 4	8' - 9"	B	18'
W15	6	# 4	8' - 10"	B	98'
W16	2	# 4	2' - 0"	B	8'
W17	1	# 4	1' - 10"	B	4'
W18	1	# 4	1' - 8"	B	4'
W19	1	# 4	1' - 6"	B	3'
W20	1	# 4	1' - 4"	B	3'
W21	4	# 4	8' - 0"	D	32'
W22	4	# 4	9' - 6"	E	38'
W23	2	# 4	2' - 4"	A	5'
W24	2	# 4	3' - 1"	A	7'
W25	2	# 4	3' - 4"	A	7'
W26	2	# 4	7' - 0"	A	14'
W27	2	# 4	7' - 7"	A	16'
W28	2	# 4	7' - 10"	A	16'
W29	6	# 4	13' - 10"	A	83'
W30	11	# 4	2' - 0"	A	22'
W31	10	# 4	5' - 0"	F	50'
W32	14	# 4	5 1/2	A	7'
W33	8	# 4	2' - 4"	C	19'

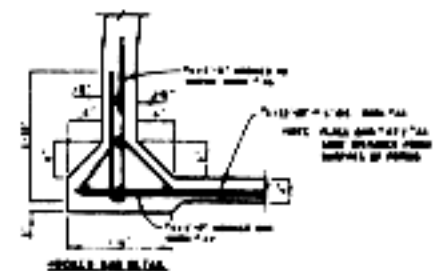
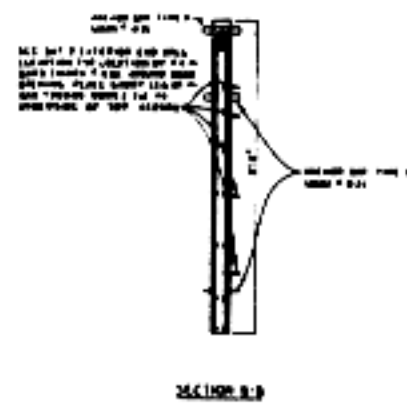
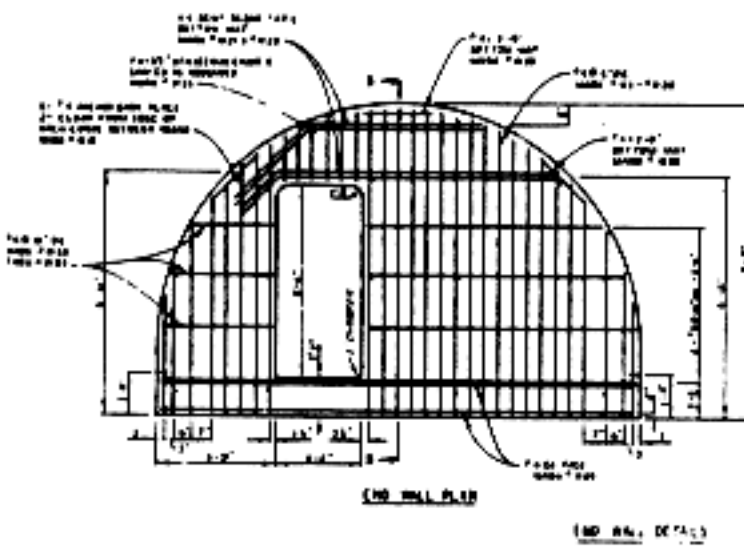
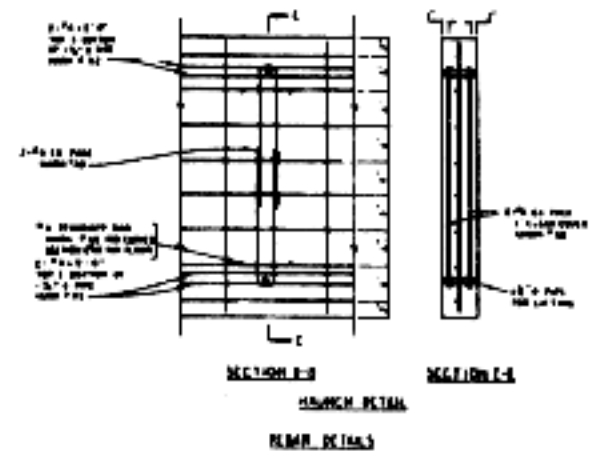
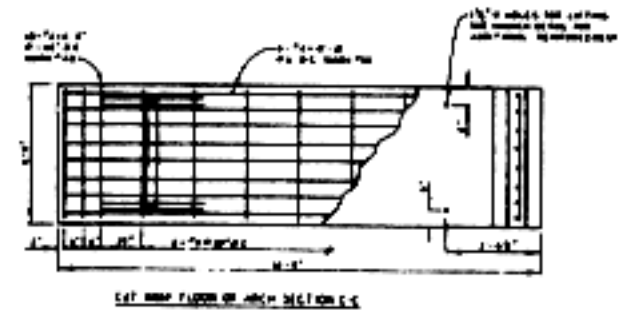
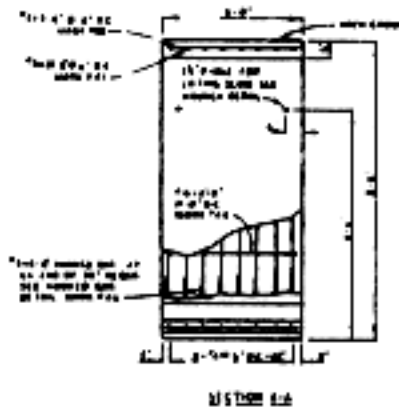
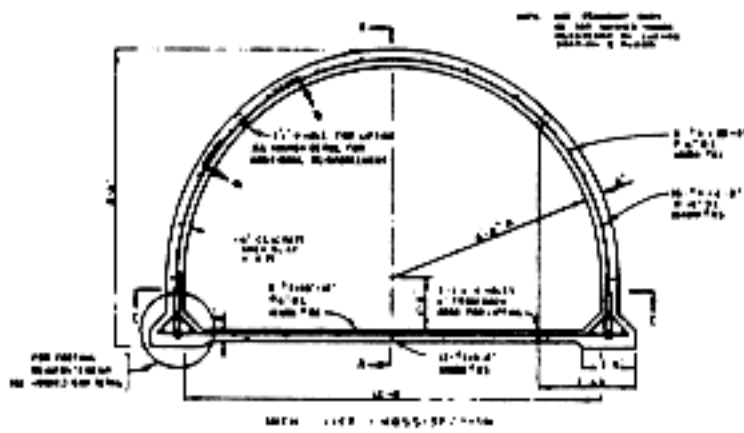
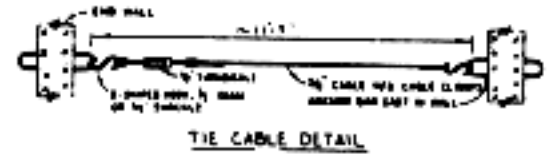
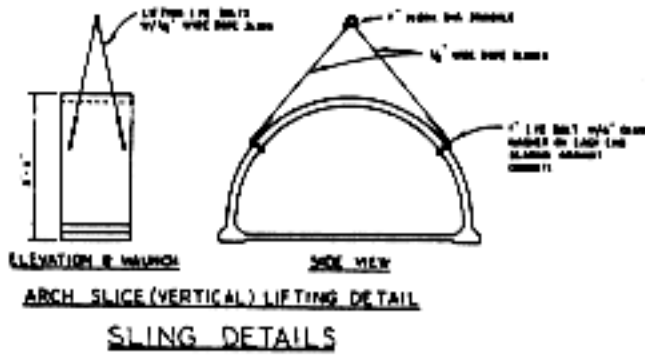
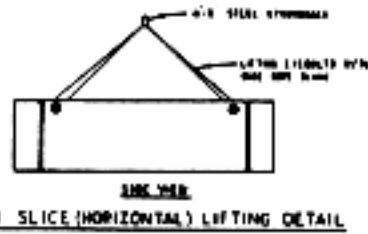
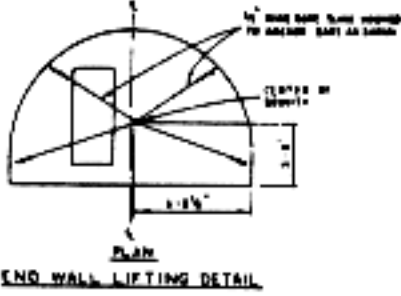
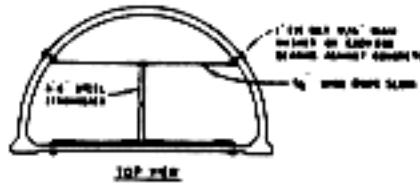
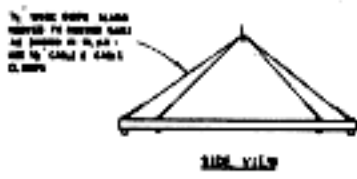



A concrete arch shelter is constructed utilizing pre-fab molds and erected on sight, or a concrete pad is poured, an earth mound is shaped on top of pad to desired dimensions and concrete is sprayed onto the upper earth portion. Later the earth is removed and placed on top of your survival shelter. Sufficient steel reinforcement is used as reinforcement to your concrete to increase shelter strength. (right) By using a steel culvert tube with ends of poured concrete a great deal of time and work can be spared. (below) A common military "KIT" for Nuclear - chemical - biological shelter utilizing steel or aluminum tubing and a fabric covering, then the entire unit is sand bagged and carefully buried. This design is in fact superior to heavy cement structures in that the fabric and tubing will "flex" under atmospheric over and under pressure, ( up to 30 psi) constant with heavy shelling, flammable liquid atmospheric detonations and Nuclear explosions. With little advance warning this type of shelter can be quickly assembled by 3 persons and occupied in as little as 24 hours. On the other hand your local scrap yard will sell tubing for pennies on the pound, Carpet installers will deliver to you the old used carpets for nothing (they have to pay to dump it), instead of expensive tubing brackets, clamps, and joints etc., wire, very tightly tied might suffice or a small welder would provide exceptional results. A couple of sheets of plywood would do nicely as a floor for long term use and you should put down your best piece of carpeting right? Wall to wall survival shelter carpeting! We sure know how to live the easy life at M&M ENGINEERING.

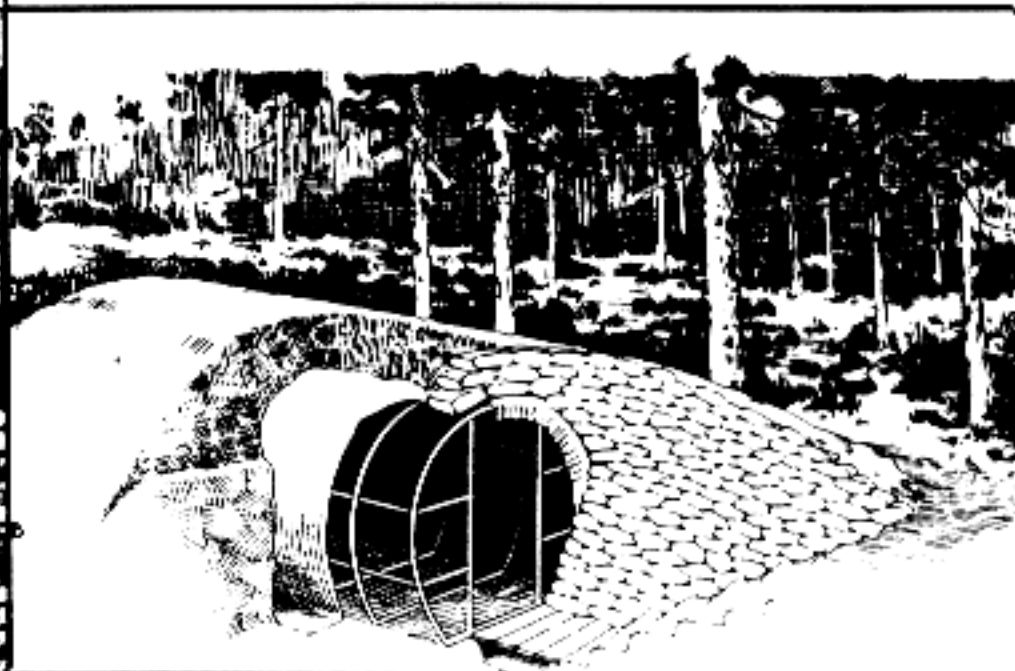
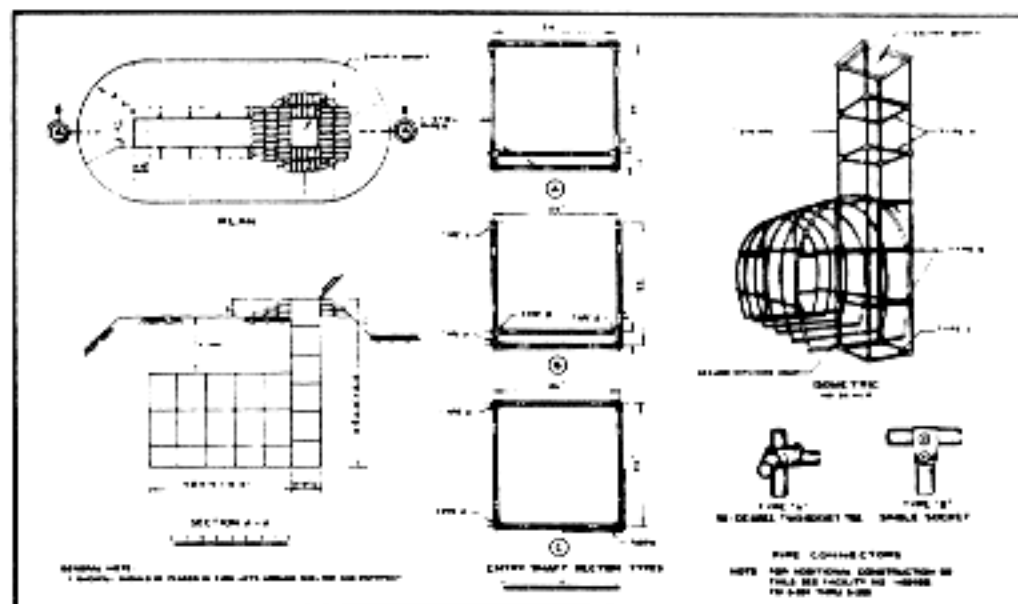
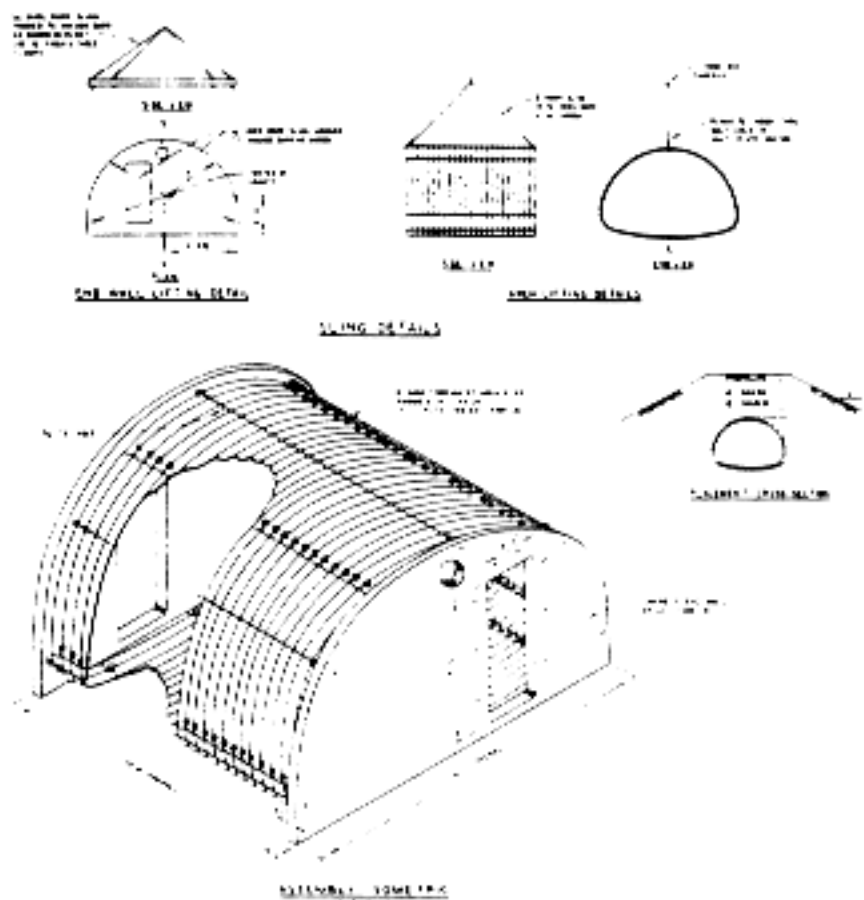

# CHAPTER 3

---

## BELOW GROUND HOME FALLOUT SHLETER

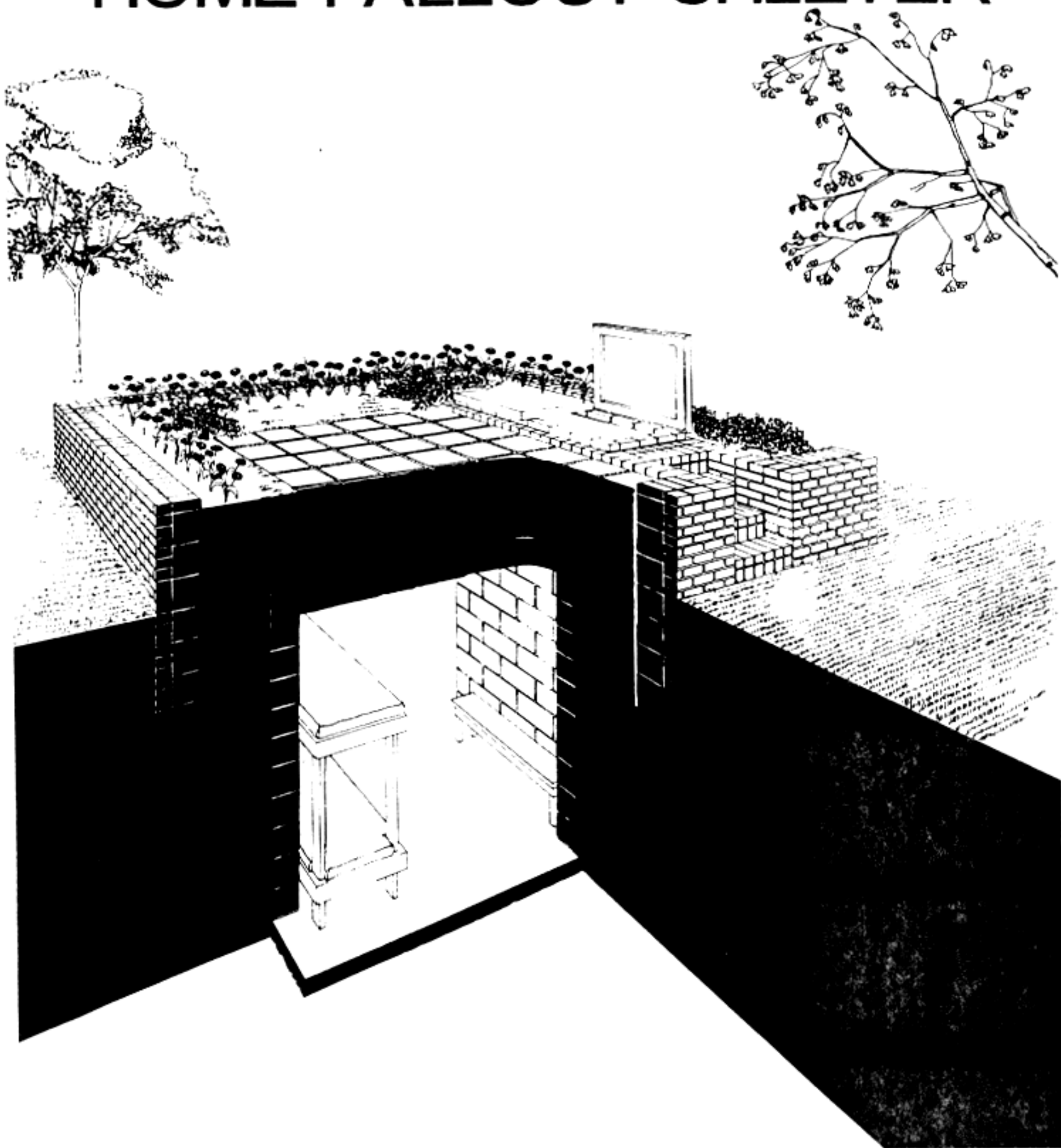

---

Shelters for homes without basements can be built in the yard when suitably protected locations within the home are not available. The shelter can have an everyday use while providing protected space from tornadoes or from nuclear fallout radiation. It can even be an attractive addition to the yard's landscaping.

The basic home shelter is relatively simple to build for a professional contractor. Construction also is possible by a "Do-It-Yourselfer" homeowner who feels equal to the challenge and has the time, but it requires hard work and several types of skills. There are a few phases, like rough carpentry and laying block and brick, that are possible for the "Do-It-Yourselfer" homeowner who proceeds with due care. Much of the work can be done without costly tools that most homeowners do not have, but contractors having specialty tools usually can do the work more quickly and more efficiently.

In this section, step-by-step procedures are given for constructing a below ground home shelter in the yard. Explanatory written instructions are supplemented with illustrative drawings. The procedures described are based upon the work being done by the homeowner rather than by a professional builder, and simple techniques are suggested that are intended to make the task as easy as possible and within the skill levels and resources of the nonprofessional builder. Other aids are provided in the form of list of tools and materials needed to complete the work illustrated. Professional builders likely already know the basics that are presented here plus much much more, and so will obtain most useful information from the plans and details.

The home shelter illustrated in this manual is but one of several possible types and sizes of shelters. Since not all possibilities can be illustrated in a single example, a word of caution is in order for those who might seek to modify the plans of the shelter that is illustrated. A special concern is that the plan dimensions of the shelter may be enlarged by the home owner who wants more space, thereby increasing the span of the overhead concrete slab. The overhead slab of the illustrated shelter is designed for the specific span shown in the shorter direction. If any greater span is used, the builder is advised to seek assistance from a qualified architect or engineer to insure that the modified structure is strong enough to carry the load. Note that the shelter size may be increased in the long dimension without adverse effect upon the structural performance of the overhead slab.

Caution also must be exercised if the depth of the shelter below the ground is increased. Additional soil pressure on the walls and roof slab may result from the greater depth. This might require that the reinforcement steel in the walls, and possibly in the roof slab, be increased.

Other features of the illustrated shelter are less sensitive to changes at least from a life safety point of view. The location of the entry hatchway may be changed to meet other needs, for example. However, in doing so, care must be taken so that the radiation shielding function of the hatchway is not compromised. Other features may be added to those shown for the illustrated shelter, such as electrically powered ventilation, drinking water and piping, toilet and waste lines, and specialty equipment, which need not create structural safety risks for users of the facility.

The particular type of shelter selected for illustration is a utilitarian structure that doubles as a space for pump and filtration equipment needed for a residential swimming pool, but there are many other possible uses for such a facility. In a active tornado region of the nation, a protective shelter alone may be desired.

The illustrated facility is modeled after a shelter constructed in the Southeastern United States where basements are not commonly found. Its below ground location near the swimming pool offers a way to protect the pool equipment out of sight and out of the way. It also provides a permanent tornado and fallout shelter. The shelter illustrated can house six adults.



## THE SHELTER PLAN

The first step in building a home shelter involves decisions about what is to be built. Plans for the shelter must be prepared. The amount of needed space must be decided; arrangements of furniture Seats, bunks, and other important large items and special equipment must be considered; yard location and everyday utility, if any must be decided; and dimensions of the shelter must be established. Normally, such information is included in construction plans that are prepared before any digging begins.

The decisions called for in the paragraph above have been made for the home shelter illustrated in this manual. Users of the manual may wish to modify some portions of the plans to suit their own particular needs.

The facility illustrated has dual use as a space for pumps and filtration equipment that serve a residential swimming pool and as a shelter. The shelter is sized to accommodate six adults, based upon a net area allowance of at least 10 sq.ft. per person, as recommend by FEMA. The facility is below ground, with the roof slab at the level of the surrounding ground surface, and with a soil cover of approximately two feet. The soil cover is retained by low garden walls or brick and block masonry. The appearance of the shelter is an elevated brick planting area which is intended as a landscape element of the yard.

In keeping with its use and purpose, the facility is not an elaborate addition to the residences. It's use as an equipment building and as an emergency shelter do not require finish quality for the inside space. To keep the cost of the facility as low as possible, only those elements essential to its functions are included namely, space for pool filter equipment, a structure strong enough to provide protection from tornado winds, shielding to provide protection from nuclear fallout radiation, and ventilation for occupants of the shelter. Other common building elements, such as heating, culinary water, and toilet, are not essential to the facility's functions as described above and so are not included. However, these and other elements can be added in most situations to meet particular desires of a family. Lighting is provided in the illustrated facility, only because electric power is needed anyway to operate the filtration equipment pump.

A plan of the facility, with one possible arrangement of shelter furnishings, is shown in figure 1. Figure 2. is a plan at the ground level and shows the planter walls and entry hatchway to the shelter. Landscape planting and paving, if any, can be decided by each owner/builder. Figure 3. shows a cross section through the facility. Dimensioned plans and details of construction are shown on pages 6 thru 9. Construction procedures and further details are described in the remainder of my manual. As will become apparent when construction is underway, the dimensions of the facility - in both plans and elevation have been selected to correspond with sizes of building materials. By doing so, material waste is avoided (a cost consideration), and construction is infinitely easier if materials do not need to be cut. Of course, cutting of some materials, such as wood and steel reinforcing bars, is unavoidable, but cutting of block and brick can be avoided or kept to a minimum by coordinating the building dimensions in the plan and elevation with modular sizes of the masonry units.

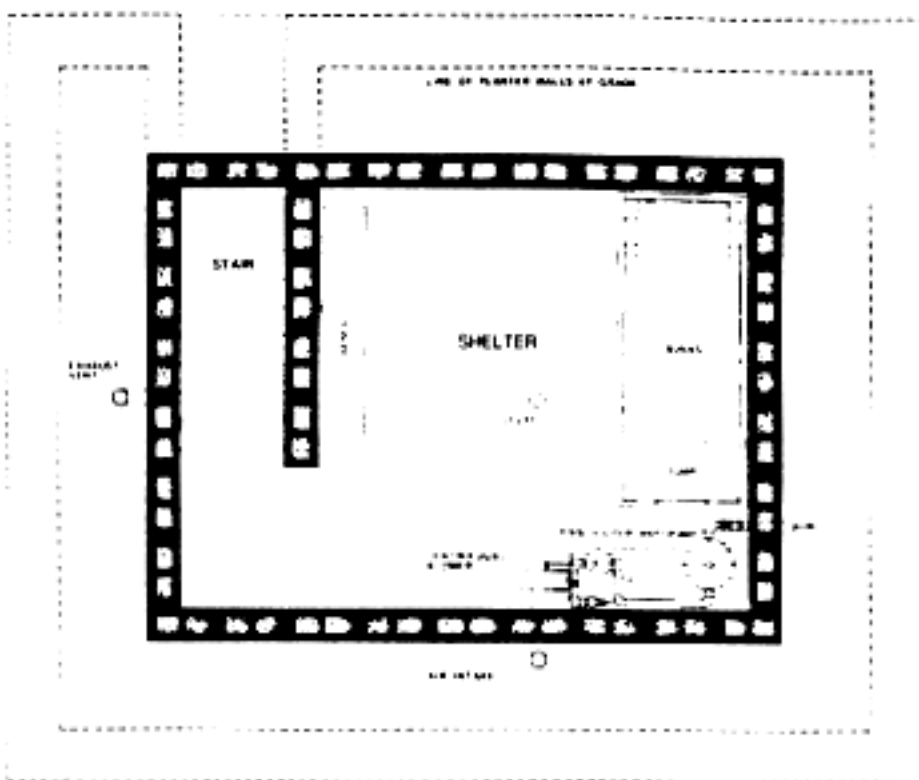

Figure 1. Floor plan of shelter

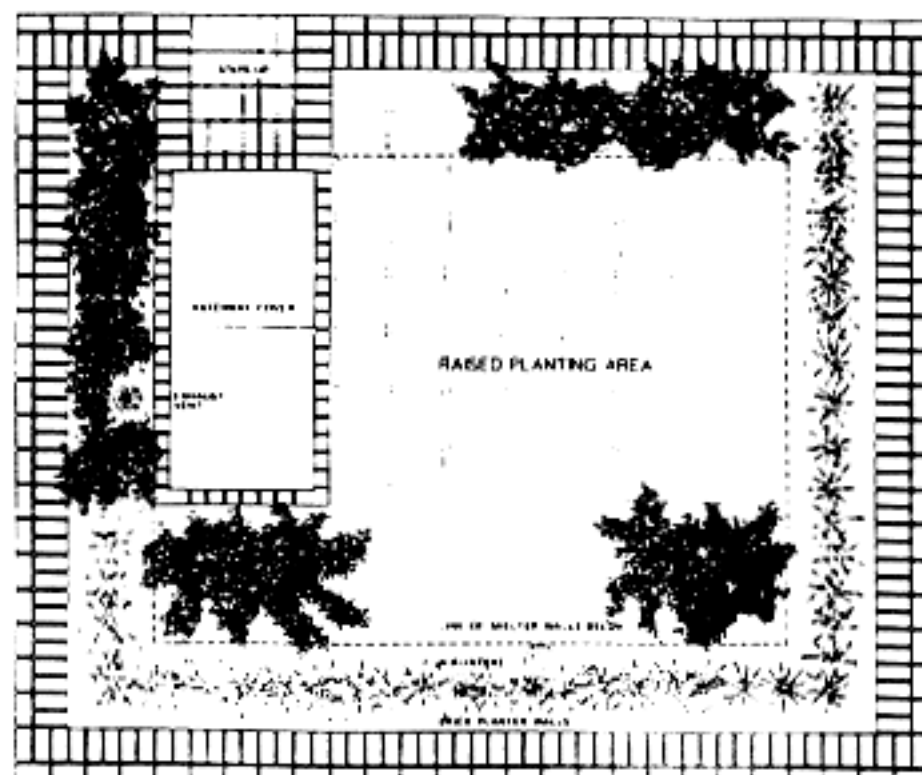

Figure 2. Plan of landscaped planting area at yard level

## SIGHT PLANNING

Sight planning refers to the location of a facility on the property. A site plan showing the relationship of the proposed shelter to existing buildings on the property and to property boundaries will likely be required by the local building department before a building permit will be issued.

Key elements of a site plan include a scale drawing showing new (proposed) and existing buildings, dimensions from property lines or from existing buildings to the new construction, and locations of utility lines (electrical power, water piping, etc.) which may be connected to the new facility. The purpose of a site plan, then, is to provide for the builder that information necessary so that the new facility, when built, will be located where the owner intends it to be and to assure that the new facility complies with applicable local planning and zoning requirements. The site plan also helps to assure that all utilities can be connected to the facility as intended, and that the new facility will fit with other elements and landscaping in the yard.

For the shelter illustrated in this manual, a hypothetical site has been selected for an existing home with a swimming pool. This hypothetical site allows the discussion on construction procedures to be more specific but has no other significance to the purposes of this manual. Each home owner will need to prepare his own site plan to fit his particular circumstances. The site plan shown in Figure 4 provides a guide that may aid the home owner in preparing his own.

## BUILDING PERMIT

One last suggestion in getting ready to build; Don't forget to obtain a building permit if one is required. Most communities require that a permit be obtained for any type of new construction. Normally, this entails filling an application form plus several sets of plans with the local building department. Payment of a fee also is normally required for the permit. If the plans meet the requirements of the local government agency, then a building permit will be issued.

Most building departments require that the permit be posted prominently somewhere at the building site and be accessible to inspectors who may on occasion visit the site to verify that the work conforms to the plans approved by the building department.

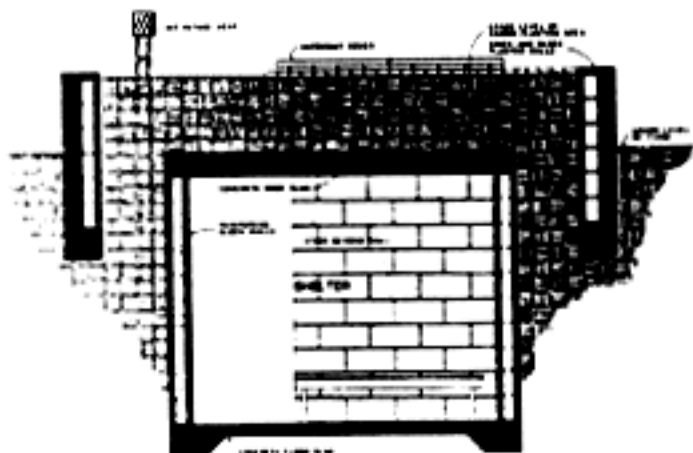

Figure 3. Cross section through the structure

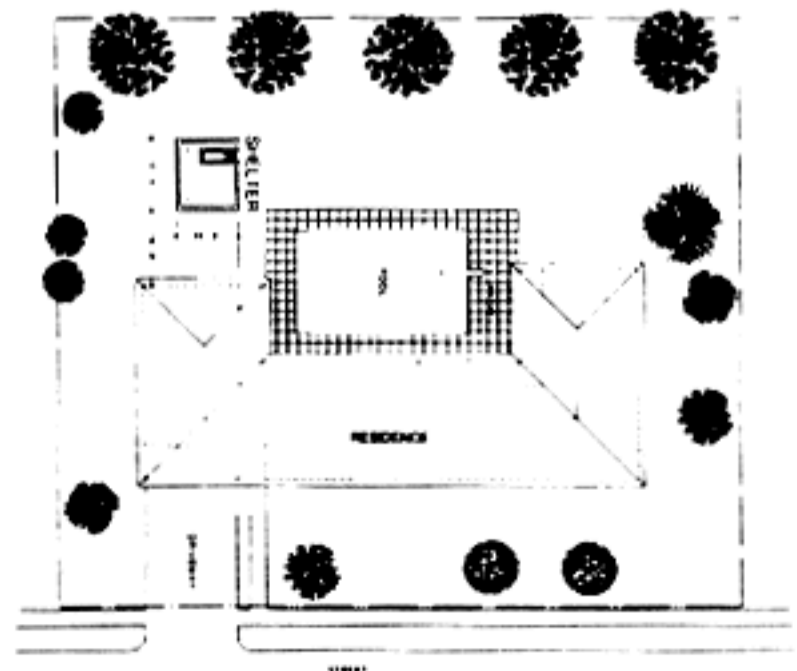

Figure 4. Location to existing residence

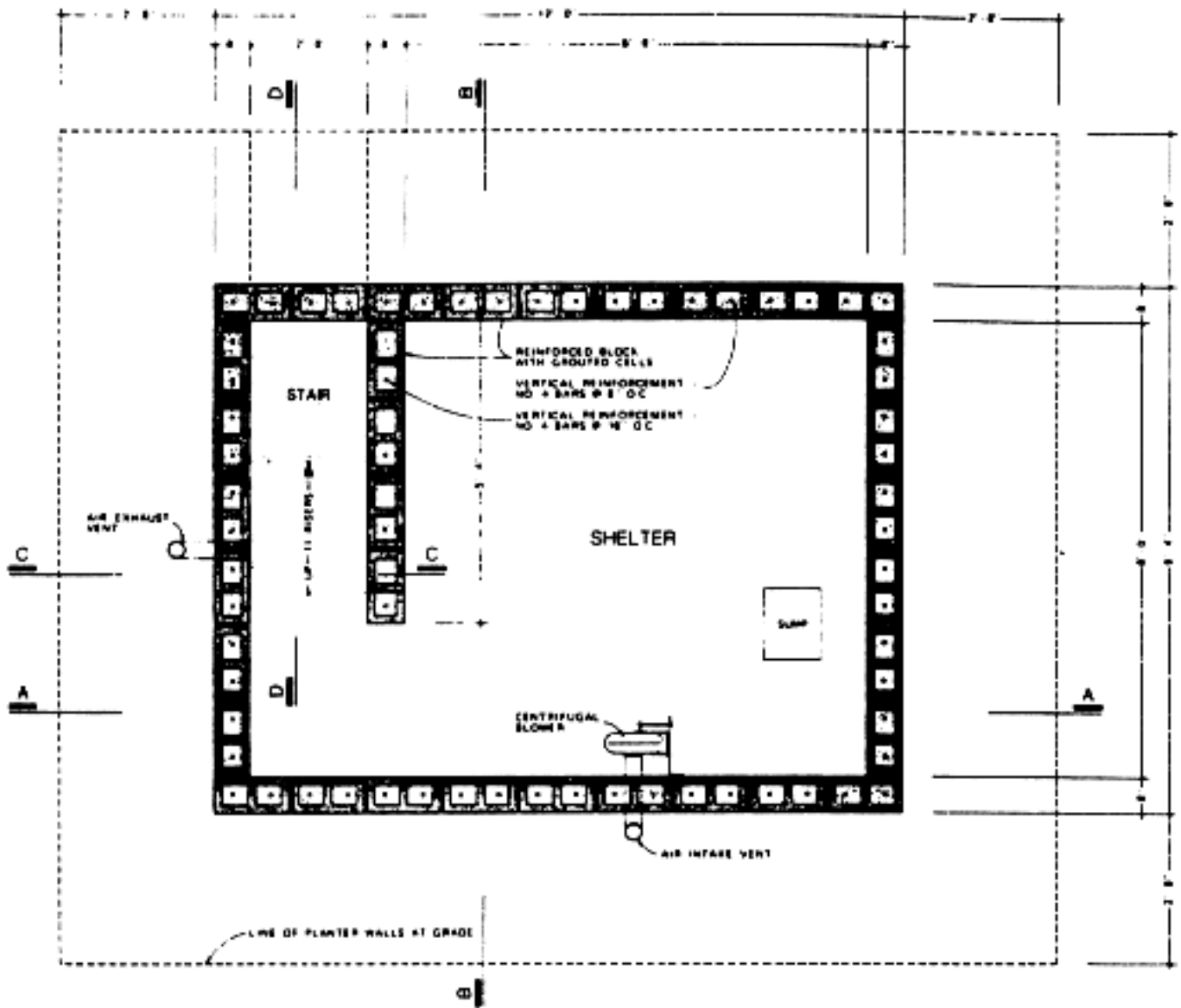

Figure 5. Dimensioned floor plan of the shelter

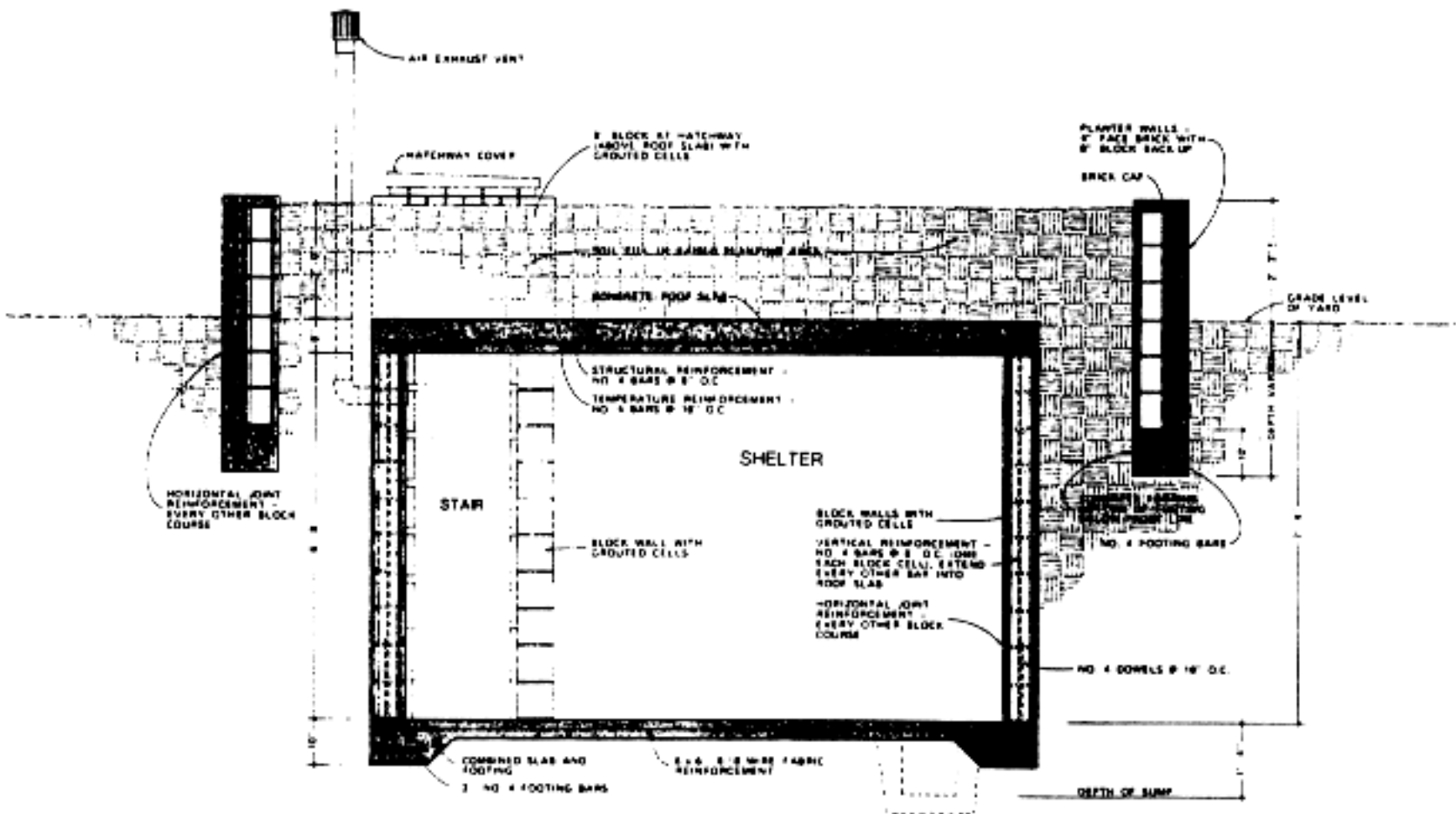

Figure 6. Dimensioned cross section A-A through the structure



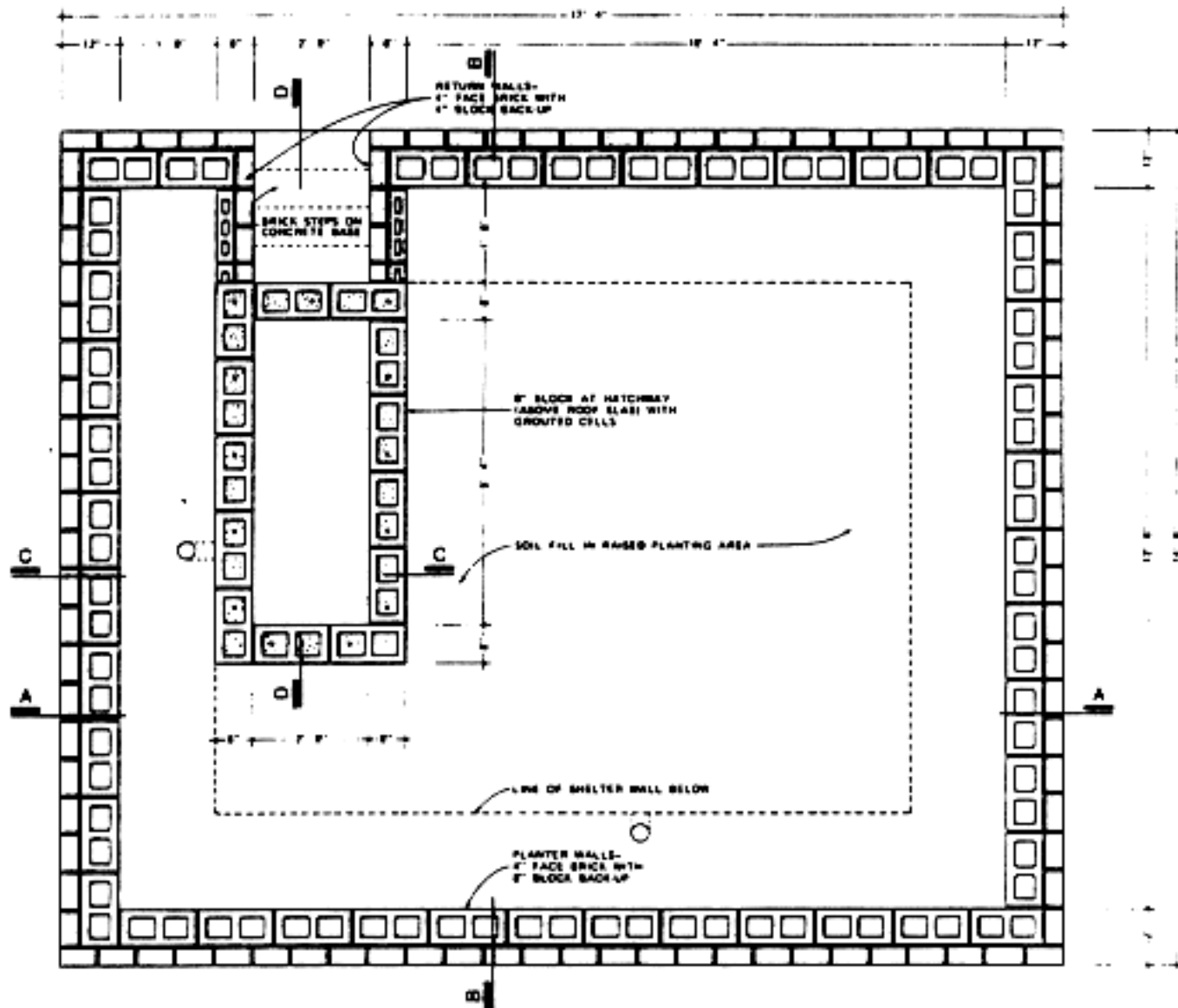

Figure 7. Dimensioned plan showing planter walls and hatchway walls

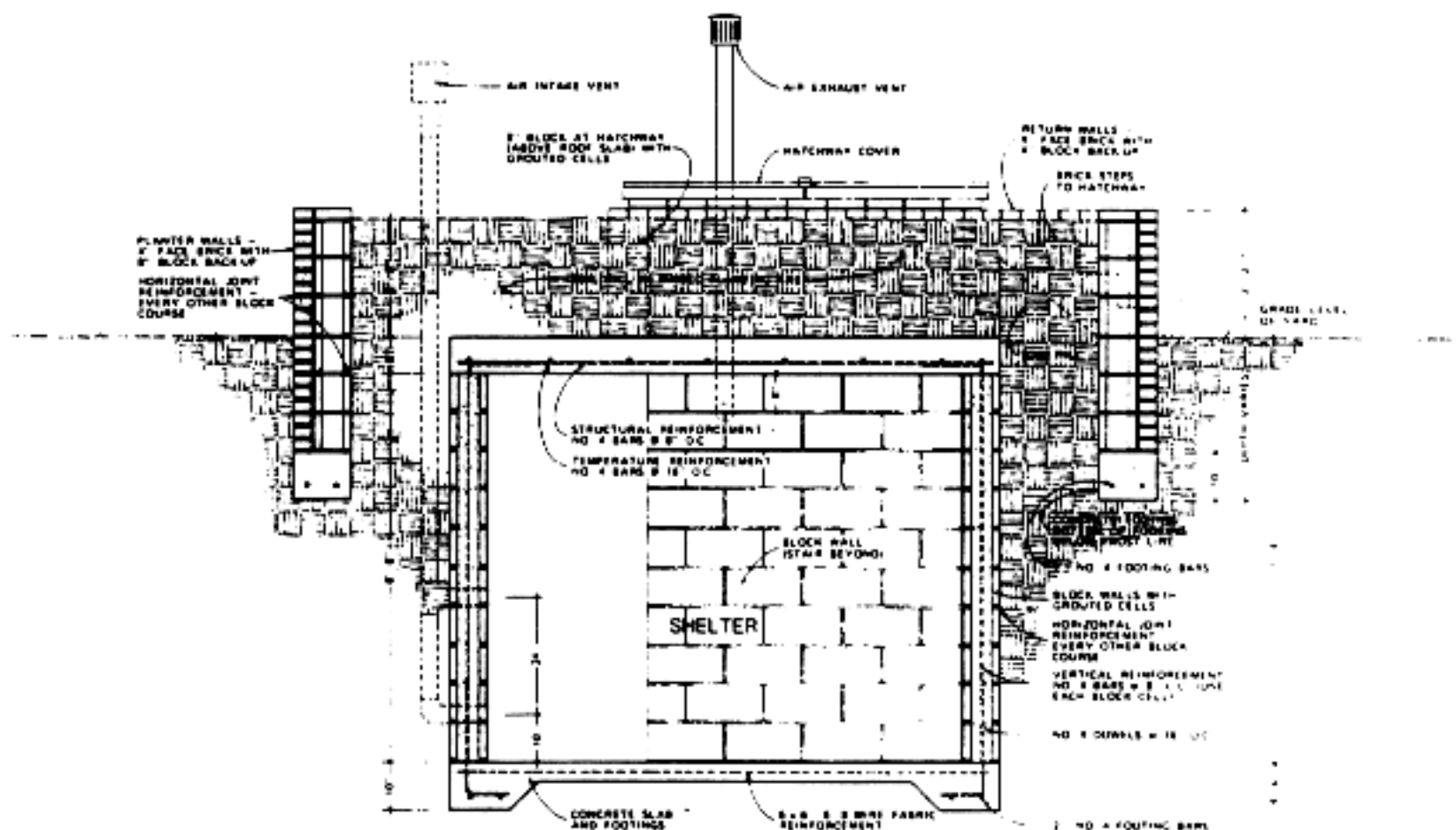

Figure 8. Dimensioned cross section B-B through the structure

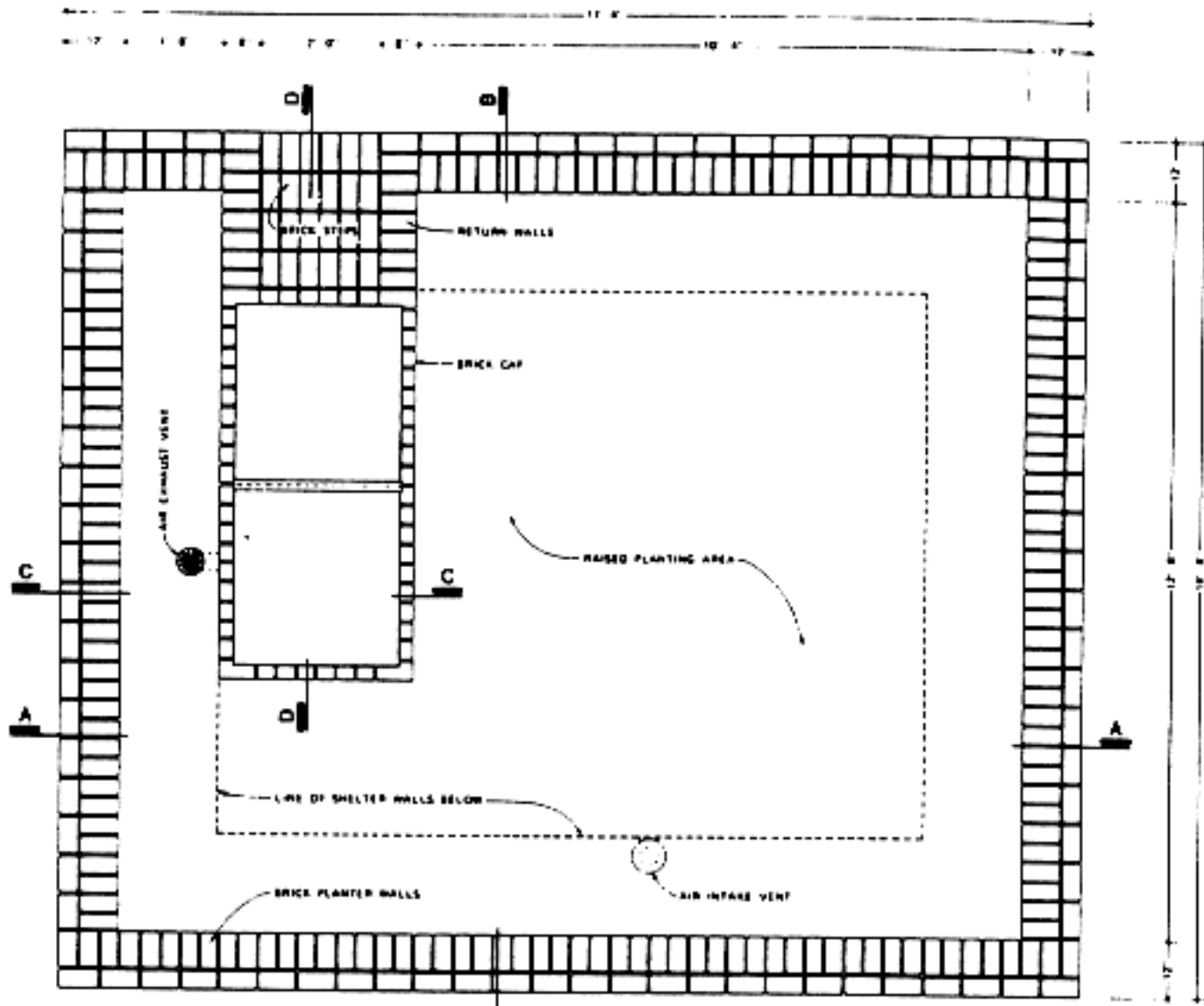

Figure 9. Dimensioned plan of the planting area at yard level

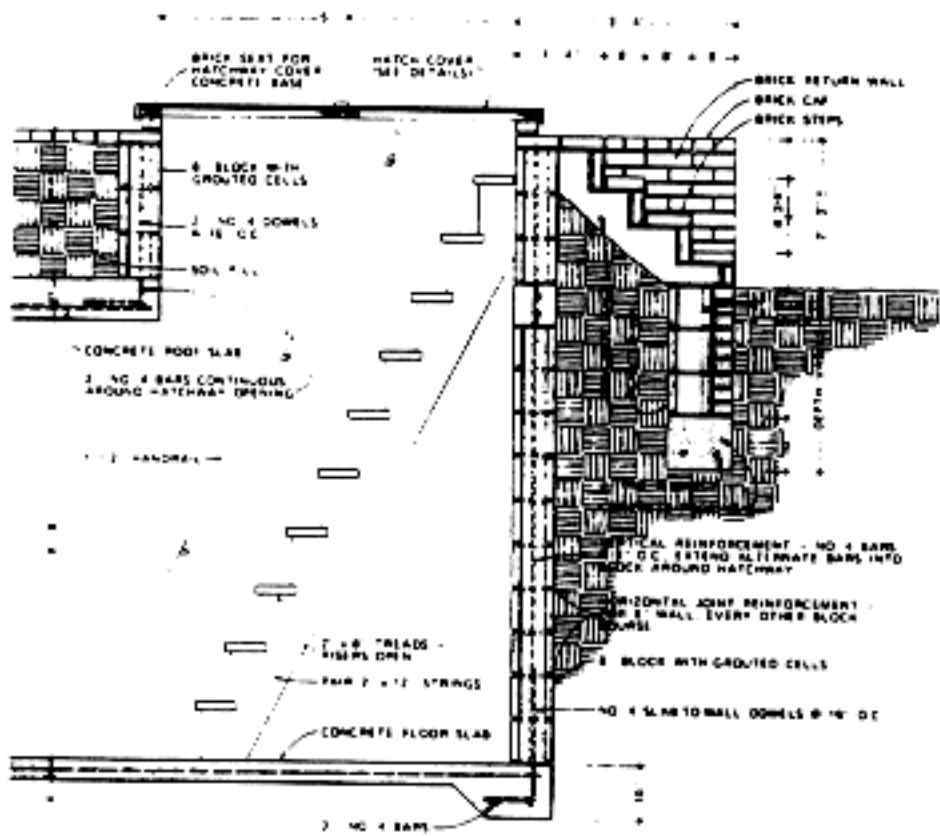

Figure 10. Section D-D at hatchway

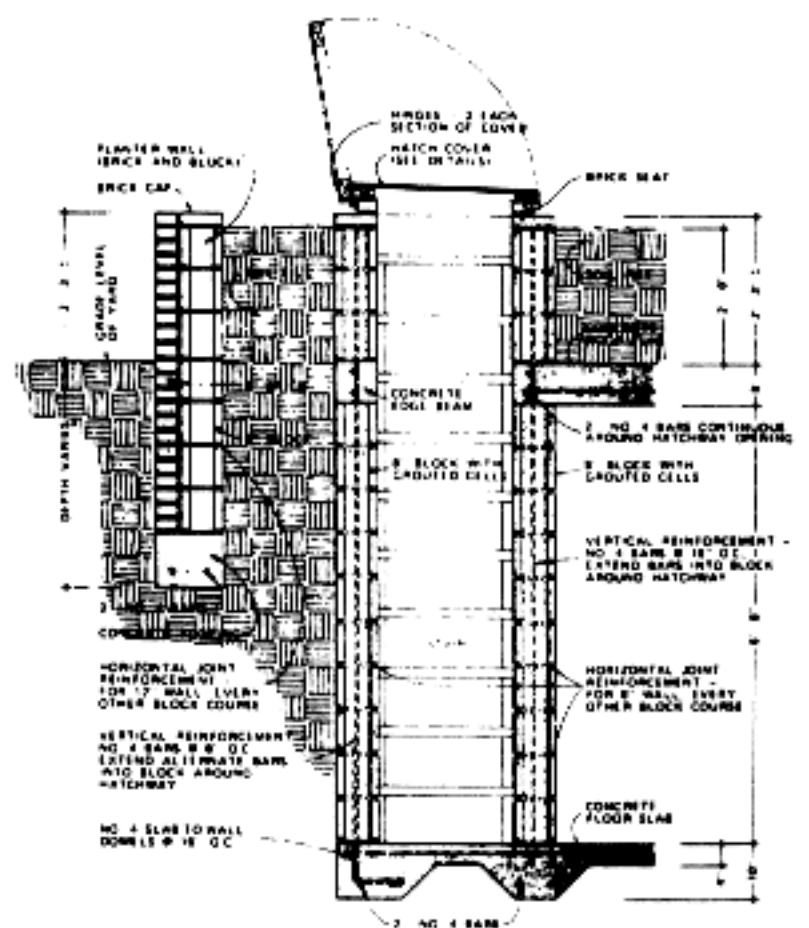

Figure 11. Section C-C at hatchway

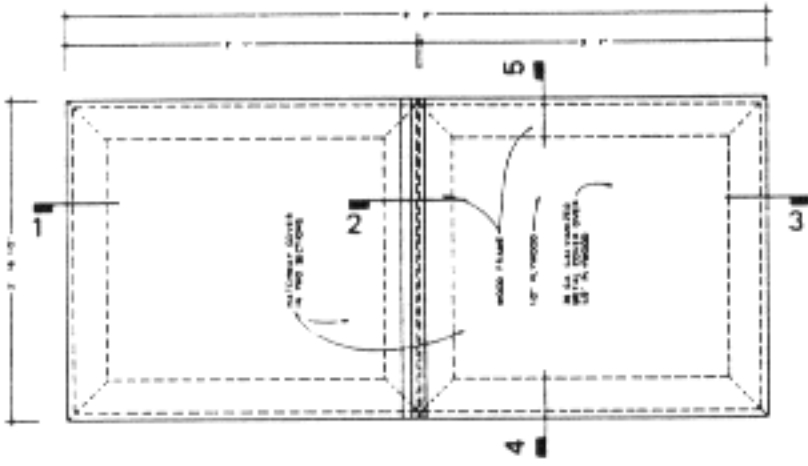

Figure 12. Construction dimensions of hatchway cover

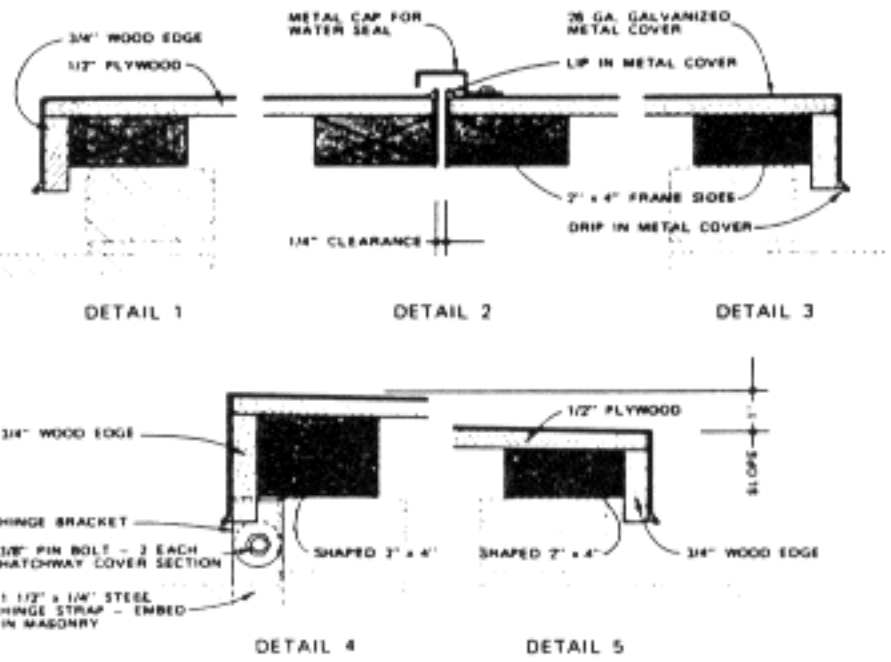
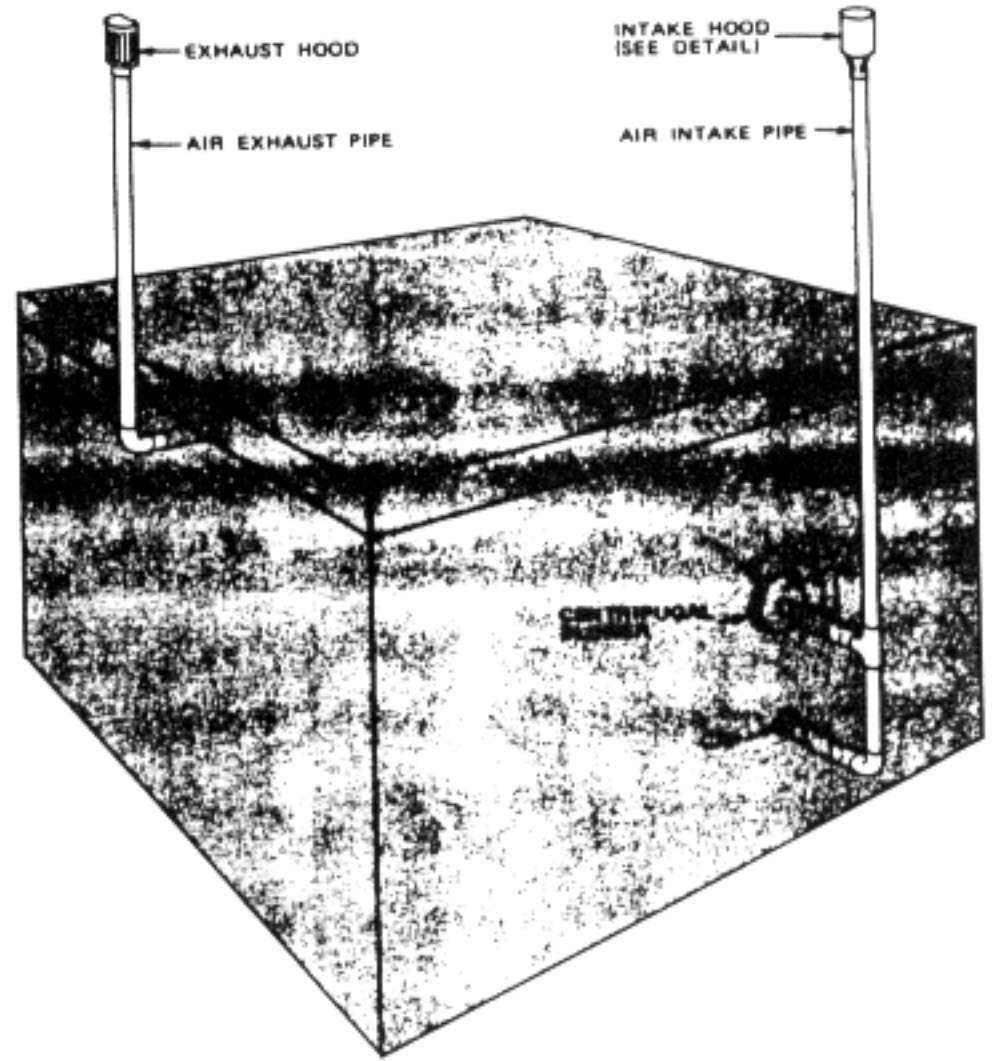

Figure 13. Construction details of hatchway cover



Fabrication 15. Piping diagram of ventilation system

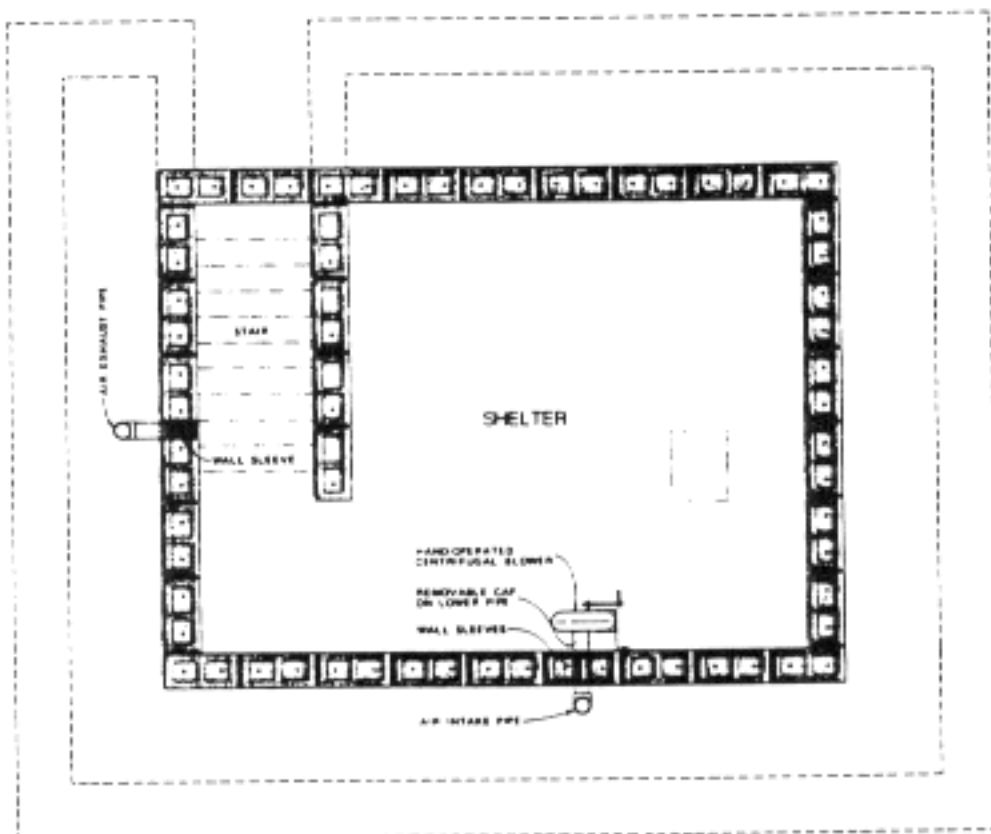

Figure 14. Plan diagram of ventilation system for shelter

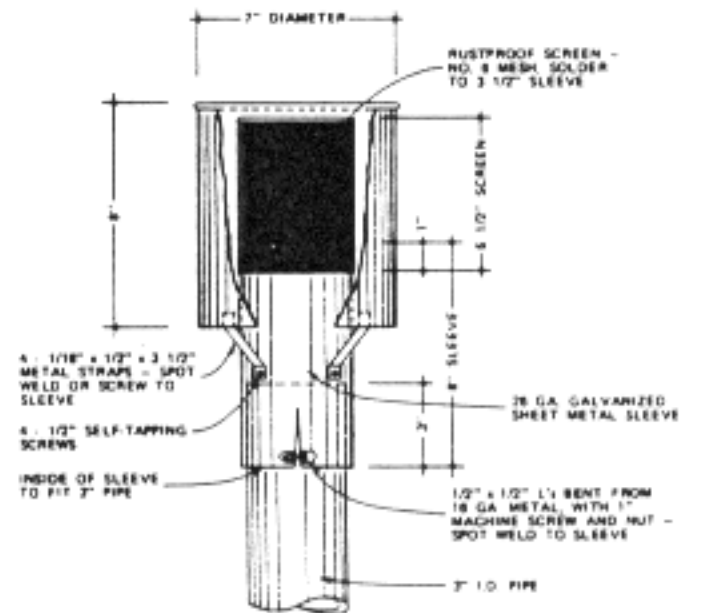

Figure 16. Fabrication of air intake system



TOOL

ESSENTIAL

NICE TO HAVE

Sledge Hammer (4 lb.)	☺	
Hand Saw crosscut	☺	
Skill Saw (hand held power saw)	☺	
Table Saw		☺
Hammer (16 oz.)	☺	
Carpenter's level	☺	
Transit Level and Rod		☺
Tape Measure (25' preferred)	☺	
Carpenter's Square	☺	
Shovel (square nose)	☺	
Bolt Cutter or Hacksaw	☺	
Rebar Chopper		☺
Wire Nippers and Pliers	☺	
Wheelbarrow	☺	
Mason's String	☺	
Brick Saw		☺
Brick Chisel	☺	
Hoe (mixing)	☺	
Water Bucket or Hose	☺	
Sheet Metal Snips	☺	

### TOOLS FOR THE JOB

Just a few steps remain in the planning phase before the construction work can begin namely, to obtain the needed tools or to know where they can be obtained as needed, to purchase the needed materials or verify that they are available for when they are needed as the construction progresses, and to obtain a building permit if needed.

Table 1. provides a list of tools likely to be needed for the construction work ahead. Because each builder is apt to work some what differently than the next, a complete tool list suitable for everyone would be difficult to prepare. Table 1. therefore is not necessarily complete, but it does include those tools deemed most important for doing the work.

Many phases of construction work are made easier by using tools specially designed for the particular purpose. The tool list given in Table 1. does not include specialty tools, but if the builder has them, or can borrow or rent them, then some portions of the work will progress much more quickly and smoothly.

One such specialty tool is the transit level which is used to establish elevations and for checking accuracy of the work as it proceeds. A concrete mixer also is handy for preparing the mortar mix. With the mixer it is even possible to mix and pour the concrete for a building the size of the illustrated shelter. There are many other types of specialty tools, pipe threaders, chop saws for cutting steel reinforcement bars, and power saws of various sorts. Regretfully, most of these specialty tools are expensive to purchase, and the time of use for construction of the home shelter probably does not justify acquiring them. Our advice; Use the specialty tools if you have them, or rent them if available, but one can get the job done in other ways.

### ESTIMATING THE MATERIALS REQUIRED

An important consideration in the planning phase is; How much will the facility cost? For the "Do-It-Yourselfer", this cost could be only the cost of the construction materials. However, it is likely that the real cost will include some contractor charges - such as for excavation work, hauling of excess soil, and possibly pouring and finishing of concrete.

Preparation of a cost estimate for materials is relatively easy. One has only to determine the type and quantity of materials and then obtain the cost for each item from a local lumber yard. Naturally, a more complete list of materials will produce a more accurate cost estimate.

Table 2. provides a relatively complete list of materials that will be needed to construct the home shelter illustrated in Figures 1., 2., 3., The list includes those materials that will remain permanently in place as well as materials required for layout and forming. Re-use of some lumber needed for layout work and forming may be possible, but this has not been taken into account in the materials list.

The materials list is incomplete in one regard. It does not include the numerous small items - nails, cord, wiring stakes etc., that will be needed, rather than trying to list all of these type of small items, it often is easier simply to provide an allowance for them in the estimate (see table 2.)

Note that table 2. provides more than just an identification of the types of needed materials. The quantity and type (or quality) of materials also are indicated. Quality of the material is important not only because the cost may be affected but also because certain characteristics may be required of the material so that it will perform as expected. For example, concrete of the correct strength must be ordered (or mixed), wood of proper grade (strength) is needed, reinforcement steel is graded by strength of the steel and by the bar size, and masonry block units of correct size, density, and cell configuration will be needed. Table 2. indicated such specifications for the materials.

# LIST OF MATERIALS

27

## SLAB AND FOOTING

Batter Boards 1"X4"	Construction	8 @ 4' - 0"
Edge Forms 2"X4"	Construction	2 @ 12' - 0"
2"x4"	Construction	2 @ 9' - 7"
Footing Reinf.steel#4bars	GRADE 40	4 @ 11' - 10"
#4bars	GRADE 40	4 @ 9' - 2"
#4bars	GRADE 40	2 @ 5' - 11"
Footing Dowels#4bars	GRADE 40	30 @ 2' - 8"
Support bars#4bars	GRADE 40	36 @ 1' - 0"
Wire Fabric 6X6-8/8	ASTM - A185	108 sq. ft.
Dowel Support 2"X4"	Construction	2 @ 12' - 0"
2"X4"	Construction	2 @ 10' - 0"
2"X4"	Construction	4 @ 3' - 0"
Sump Forms 2"X4"	Construction	4 @ 1' - 4"
1/2" Plywood	C - D	1/2 pc. 4'X8'
Concrete	2,500 PSI	2.75 cu. yds.
Block 8"	Concrete	380 units

## SHELF WALLS

Horiz. joint reinf. 8" wall	TRUSSEDWIRE	212 lin. ft.
Prefab. Corner Reinf. 8"wall	TRUSSEDWIRE	20 pieces
Vertical reinf. steel#4bars	GRADE 40	23 @ 8' - 0"
#4bars	GRADE 40	30 @ 6' - 8"
Hatchway Vert. Steel#4bars	GRADE 40	11 @ 9' - 4"
Hatchway Dowels#4bars	GRADE 40	2 @ 3' - 4"
Mortar	TYPE S	17 cu. ft.
Grout	TYPE S	94 cu. ft.

## ROOF SLAB

Shoring Lumber 2"X4"	Construction	27 @ 6' - 7"
2"X6"	Construction	7 @ 8' - 0"
2"X6"	Construction	5 @ 2' - 8"
Deck Forms 1/2"plywood	C - D	2 1/2 pieces
Edge Forms 2"X10"	Construction	2 @ 12' - 0"
2"X10"	Construction	2 @ 9' - 7"
Hatchway Edges 2"X10"	Construction	2 @ 5' - 1"
2"X10"	Construction	2 @ 2' - 0"
2"X4"	Construction	2 @ 1' - 9"

Concrete	Concrete	2.75 cu. yds.
Dampproofing	6 mils Polyethylene	760 sq. ft.

## PIANTER WALLS

Footing forms 2"X10"	Construction	2 @ 17' - 7"
2"X10"	Construction	2 @ 15' - 4"
2"X10"	Construction	2 @ 14' - 8"
2"X10"	Construction	2 @ 12' - 5"
Footing reinf.#4bars	Grade 40	4 @ 17' - 0"
#4bars	Grade 40	4 @ 14' - 4"
Ftg. bar support#4bars	Grade 40	44 @ 1' - 0"
concrete	2,500 PSI	2 cu. yds.
Blocks 8"	Concrete	258 units
4"	Concrete	10 units
Brick standard	standard	2,100 units
Hoz. joint 12"wall	Trussed wire	130 lin. ft.
8" wall	Trussed wire	16 lin. ft.
Prefab. corner 12" wall	Trussed wire	8 pieces
mortar	Type S	40 cu. ft.

## HATCHWAY COVER

Framing lumber 3"X4"	Construction	2 @ 3' - 0"
2"X4"	Construction	2 @ 3' - 0"
2"X4"	Construction	4 @ 2' - 9"
Cover 1/2" plywd.	C - D	1 pc. 4'X8'
Trim 1"X4"	No. 2 Pine	24 lin. ft.
Sheet metal	26 Ga.	2 @ 14 sq. ft.
Hinges		4 pieces

## STAIRS

Strings 2"X12"	No. 2 Fir	2 @ 12' - 0"
Treads @"X8"	No. 2 Fir	10 @ 2' - 0"

## VENTILATION

Centrifugal blower		1 unit
wall sleeves 8"long	Steel or ABS	3 pieces
Piping 3" ID.	Steel or ABS	22 lin. ft.
90 elbows 3" ID	Steel or ABS	2 pieces
Tees 3" ID	Steel or ABS	1 piece
Intake filter		1 unit
Exhaust filter		1 unit

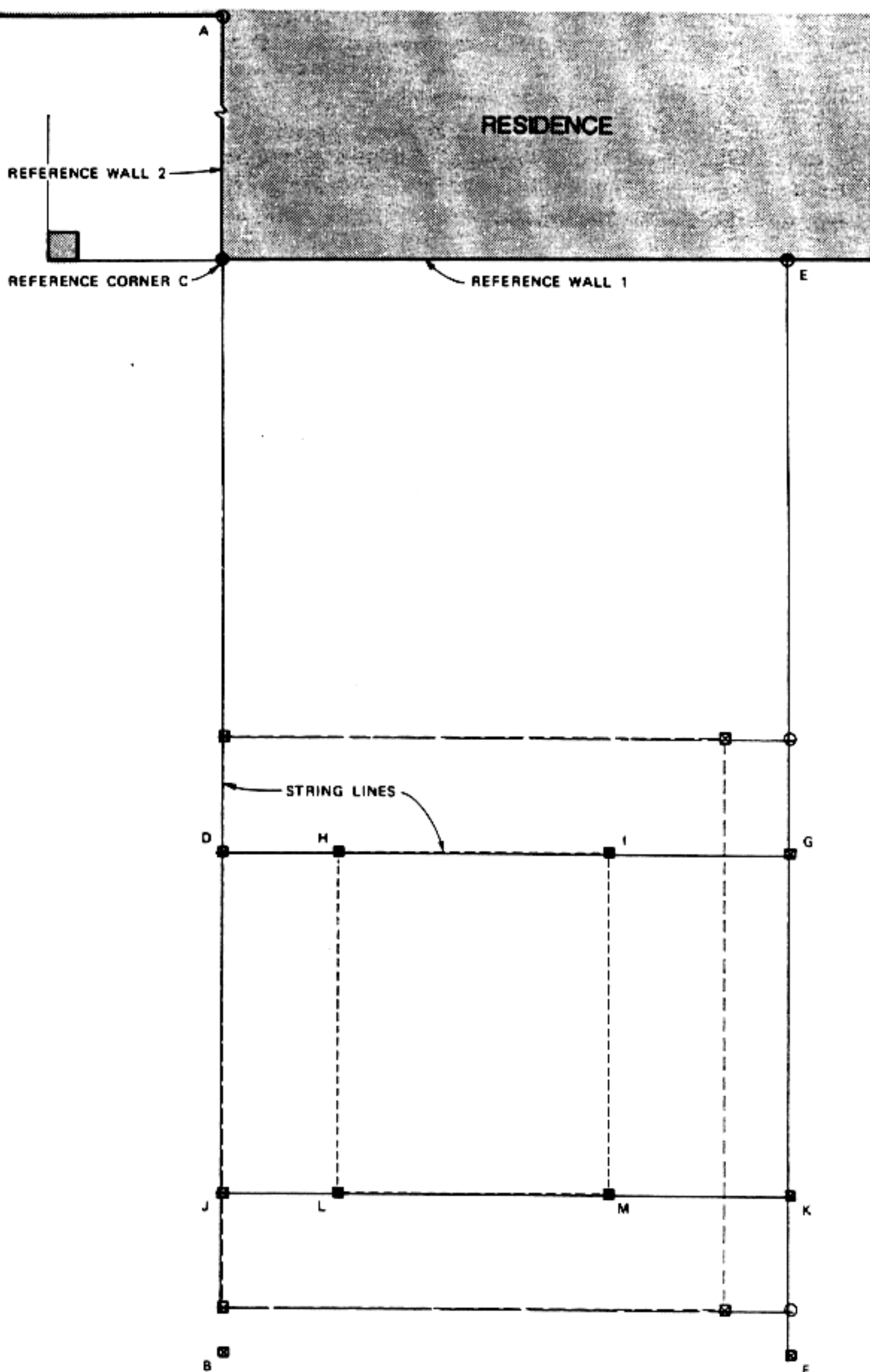

Figure 17. Stake layout for locating corners of the shelter



The area to be excavated, marked at the ground surface, therefore is larger than the area at the base of the hole by a dimension in each direction equal to the slab dimension plus an allowance for working space plus an allowance for the slope of two times the horizontal component of the slope (see figure 19). Corner stakes should be set at the ground surface to fit these dimensions.

The area for excavation, as defined by string stretched between stakes, should be marked in a more permanent way before the excavation work begins so that the lines are not lost when heavy machinery disturbs the site. An easy way to do this is with a spray paint on the grass or ground along the string lines.

### **CHECKING THE ACCURACY OF THE WORK**

Accuracy of the layout should be checked at this point. Precision is not essential at this time, because corner stakes for the shelter slab still must be set after the excavation pit is dug. Nonetheless, it is a good idea to check accuracy of the work to insure that the hole will be excavated where it is intended to be located. Also, a check on accuracy at this time will provide experience for the more precise checking that should be done later.

Two aspects of the work can be checked for accuracy at this time: 1. measurements from the point of reference, and 2. squareness of the area to be excavated.

A common problem in all construction work is creating right-angle (square) corners. Verification of the squareness of the initial layout can be made readily using certain geometric characteristics of a rectangle. If the diagonals of the rectangle are equal, then the sides of the rectangle necessarily intersect at right angles. If the diagonals are not equal, then the corner stakes should be adjusted slightly until the diagonals are equal.

### **STEP ● BY ● STEP ● PROCEDURES**

#### **LOCATING THE SHELTER CORNERS**

**Step 1:** Extend a string line several inches above the ground level from A to B (see figure 17). B is any selection distance from reference wall 1, preferably slightly greater than the distance to the outermost edge of the shelter. The string line should be in line with reference wall 2, and when held taut should just touch reference corner C without bending the string line. Line A B then will be perpendicular to reference wall 1 and also will be a projection of reference wall 2. Set temporary stake B and drive a nail into its top precisely in line with the string line.

**Step 2:** Select a point E along reference wall 1, preferably at a distance greater than the width of the shelter. Extend another string line from point E perpendicular to reference wall 1 (at this time the perpendicular can be estimated by sighting). Extend the string line to point F which is selected at the same distance from reference wall 1, as is B. The perpendicular can be checked initially by measuring the distance from C to E and adjusting the string line E F until the distance from B to F is the same as the distance C E. Drive a temporary stake at F and place a nail at the correct measured distances from E to F and B to F. That the line E F is truly perpendicular to reference wall 1, can be checked by measuring the diagonals C F and E B. If these diagonals are equal, then the lines C B and E F are perpendicular to reference wall 1. If the diagonals are not equal, adjust stakes B and of F slightly until the diagonals are made equal.

**Step 3:** Measure from reference corner C along string line A B the distance from reference wall 1 to the closer wall of the shelter (18' - 0" in the example). Push the string line out of the way and drive temporary stake D. Release the string line out of the way and drive temporary stake D in line with the string line and at the correct distance from reference wall 1.

**Step 4:** Locate point G along string line E F at the correct distance from reference wall 1 (the same distance as C D), and place a temporary stake at G, with a nail in the stake at the correct distance E G and in line with string line E F. Another string line stretched between stakes D and G locates the shelter wall closest to the house.

**Step 5:** The corners of the shelter, points H and I, are located by measuring along string line D G from stake D to the correct distance that are indicated on the site plan. Corner stakes H and I can be driven and marked with nails at the correct distance and in line with string line D G.

**Step 6:** The outermost corners of the shelter, L and M, are located by first setting stakes J and K, measured the length of the shelter walls along string lines C B and E F, respectively, from points D and G to points J and K. Set the temporary stakes J and K, and stretch another string line from J to K. Shelter corners L and M then are located along string line J K in the same manner as described in step 5.

## DECIDING HOW MUCH SOIL TO EXCAVATE

There are several good reasons for keeping the size of the excavation for the shelter as small as possible. First the excavated soil must be either stored at the site or hauled away. Second, excavation work will scar the surrounding yard, which may be a matter of concern to many homeowners especially if the yard is landscaped. While these problems cannot be eliminated, they certainly can be controlled by planning ahead of time how much soil to be excavated.

The shelter design illustrated in this booklet has considered the scope of the excavation work, and the particular design solution needs to minimize the amount of soil to be excavated and removed. The depth of the excavation has been reduced by setting the roof slab, a technique which provides protection equal to the protection of a below ground location. The design reduces significantly the amount of soil to be excavated as compared with the same amount that would need to be excavated if the structure were fully buried below ground. Reductions in the amount of soil to be removed occur both by reducing the depth of the excavation and as a consequence of the reduced depth upon the slope of the side walls of the excavation (see the insert example on this page which illustrates these reductions).

The shelter illustrated here measures 9' - 4" X 12' - 0" in plan. A combined slab and footing is used, so footings do not extend beyond the walls of the shelter. An additional 14" are provided on each side of the slab for forming and working space. The excavation is to be 7' - 8" deep to the bottom of the floor slab (underside of the slab, not its top surface). For the example shelter, soil conditions are assumed that will permit side wall slopes of approximately 1:2 ratio horizontal to vertical. The dimensions of the excavation therefore are:

At the Bottom - 11' - 8" X 14' - 4"

At ground Level - 19' - 8" X 22' - 4"

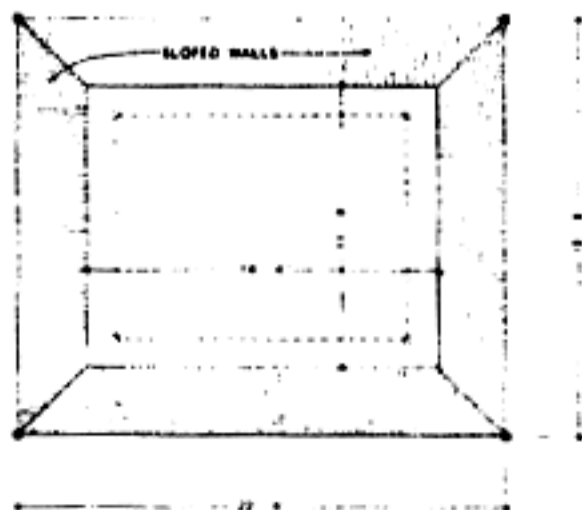

Figure 18. Plan of area to be excavated

## MINIMIZING THE AMOUNT OF SOIL TO BE EXCAVATED

To illustrate the importance of selecting the minimum size hole for excavation, comparative data is given for two similar shelters which use different techniques to achieve the same amount of soil cover on the roof. Example 1 is the shelter illustrated in this manual. Example 2 is a shelter of the same size which is buried below ground with a soil cover of 2 feet (the same amount of soil covers example 1 except that the roof slab is flush with the surrounding yard for example 1).

### Example 1

Excavation size at the top - 19' - 8" X 22' - 4"

Excavation size at the bottom - 11' - 8" X 14' - 4"

Depth of the excavation 7' - 8"

Amount of soil to excavate 83 cubic yards

Amount of soil reused for back fill, roof, and planter - 59 cubic yards

Amount of soil to be hauled from site - 24 cubic yards

Weight of soil to be hauled - 32 tons

### Example 2

Excavation size at the top - 21' - 8" X 24" - 4"

Excavation size at the bottom - 11' - 8" X 24' - 4"

Depth of the excavation - 9' - 8"

Amount of soil to excavate - 118 cubic yards

Amount of soil reused for back fill and roof cover - 86 cubic yards

Amount of soil to be hauled from the site - 32 cubic yards

Weight of soil to be hauled 43 - tons

Example 2 requires excavation and hauling of an additional 11 tons of soil above the soil to be excavated and hauled away from the site in example 1.

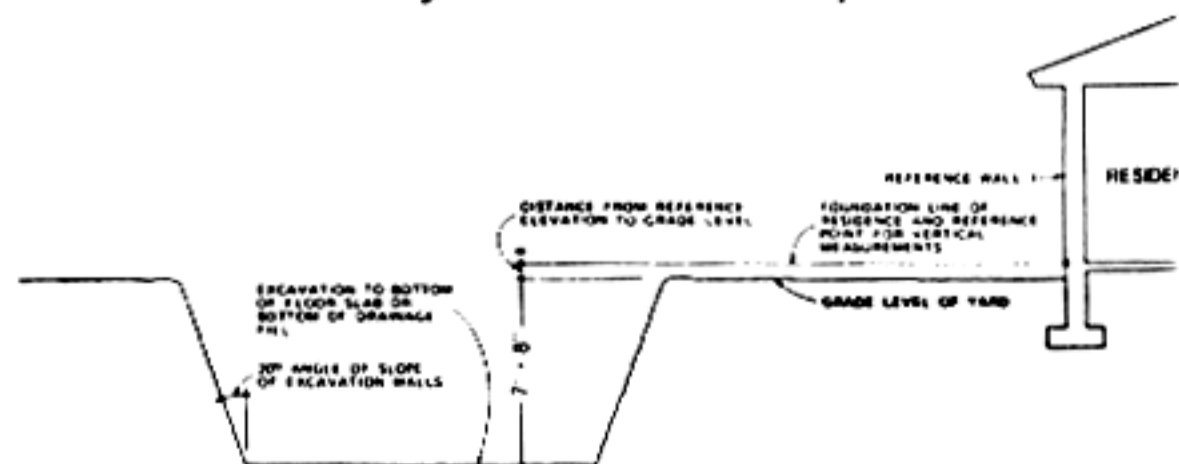

Figure 19. Cross section of excavation area







## ESTABLISHING AND MEASURING THE DEPTH OF THE EXCAVATION

The final depth of the excavation is measured to the bottom of the floor slab (for the example shelter) or to the bottom of drainage fill if such is required. Drainage fill is a bed of gravel, typically about 4" thick, commonly placed under slabs bearing on soils of clay content that tend to impede the flow of water away from the concrete. The gravel base keeps the water away from the slab, provided that some provisions are made for free drainage of water out to the gravel base such as the means of drain tile leading to an outer (or into a larger) gravel filled basin. Each builder will need to examine the soil conditions of his site to determine whether or not the drainage fill is needed.

For the example shelter, the depth of the excavation is established relative to the point of vertical reference (see figure 20 and 21) based upon dimensions taken from the plans. The point of vertical reference is 8" above the surface of the ground in the example facility, and the depth of the excavation below the point of vertical reference is 8' - 4" (7' - 8" plus 8").

Vertical measurements can be made with a transit level as is described in the insert on page 32. For the builder who does not have a transit level, a length of hose, a measuring tape, and a bucket of water can be used with the same results. The water filled hose procedure is described in the insert on this page.

## SETTING CORNER STAKES IN THE EXCAVATION

The corner of the floor slab within the excavated area are set in much the same way as was described earlier. However, additional steps will be necessary in the task at hand, because the string lines across the excavation area in each direction where, after they are correctly aligned, they can be tied temporarily to stakes set at the surface level of the yard. At the points of intersection of the string lines (the corners of the slab), suspend a plumb bob down to the bottom of the excavation and mark the points. The four corners of the slab thereby can be located at the bottom of the excavation, and corner stakes can be driven. Nails should be driven into these corner stakes at the precise location of the point of the plumb bob dropped from the intersecting strings.

String lines connect the nails in these corner stakes will indicate the edges of the floor slab. Squareness of the slab should be checked by measuring across the diagonals, and corner stakes should be adjusted slightly until the diagonals are equal.

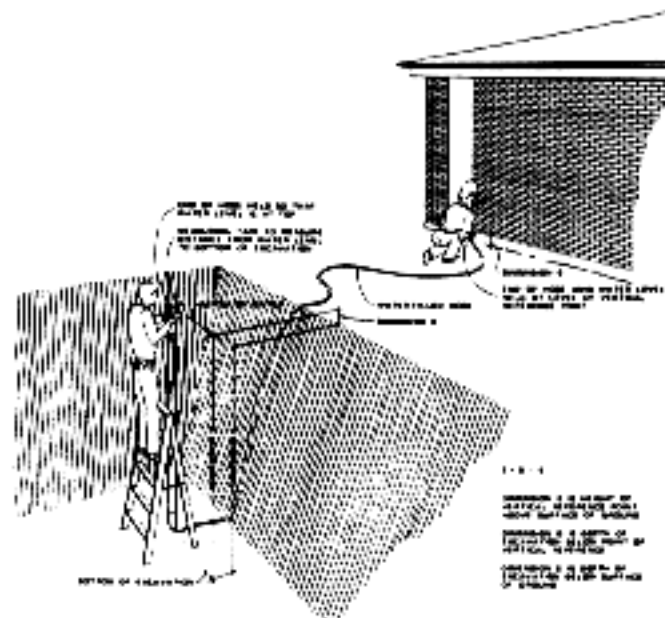

Figure 22. Determining the depth using water hose

### STEP ● BY ● STEP ● PROCEDURE

#### CHECKING DEPTH OF THE EXCAVATION WITH A WATER FILLED HOSE

THE BASIC PRINCIPLE OF THIS PROCEDURE IS THAT WATER WILL FLOW TO THE SAME LEVEL AT BOTH ENDS OF A DRAPED HOSE.

**Step 1.** With the aid of a helper, drape a length of ordinary garden hose from the point of vertical reference into the excavation pit. Hold the end of the hose at the vertical reference point vertically upward so it is precisely at the same height as the reference point.

**Step 2.** In the excavation area, hold the other hose at the approximate height of the vertical reference point and fill the hose with water from the end next to the vertical reference point. Fill the hose up to the level of the vertical reference point, raising or lowering the end into the excavation pit until the water at that end is level with the top of the hose end and ready to spill over. The level of the water at both ends of the hose always will be the same.

**Step 3.** In the excavating area, measure from the water level at the end of the hose down to the bottom surface of the excavation. This measurement is the depth of the excavation relative to the point of vertical reference. Repeat this procedure as the excavating work nears completion so that over excavation does not occur. Measurements should be taken at several locations in the pit so that the bottom surfaces is level when the excavation work is completed.

## COMBINED FLOOR SLAB AND FOOTINGS

Form work and placement of the concrete floor slab and footings are described in this section. The work includes the following task.

① Placement of batter boards at corners. (batter boards are used to control the elevations of the surface of the slab and to align edge forms for the concrete work.)

- ① Excavation of footing trenches.
- ② Placement of edge form boards of the slab.
- ③ Placement of steel reinforcement in the slab.
- ④ Locating and forming opening in the slab (a sump for the example shelter)
- ⑤ Pouring and finishing the concrete slab.

The shelter illustrated in this manual uses a combined slab and footing sometimes called a turned down slab in which the slab is thickened at the edges and thereby serves also as a footing.

The function of a footing is to distribute the weight of a structure and any load it might carry onto the soil. This load for the example shelter consists of the weight of the walls, roof slab, and soil placed atop the roof. Turned down slabs work well for small structures that do not carry heavy loads and they simplify construction over the case when separate wall footings must be provided. Their disadvantage is that cracking of the foot slab may occur if the load carrying capacity of the soil is less than the actual load bearing upon the soil. Ordinarily, this problem can be handled by thickening the slab at its edges plus any other locations where the wall loads are transferred to the soil and by adding extra reinforcing steel in the thickened portions.

The elevation of the floor slab (depth below ground) is established in conjunction with placement to the edge forms. So that the edge forms for the slab can be placed and their height adjusted without working on top of the corner stakes (which could result in their being moved indifferently), batter boards are placed at the corners as shown in Figure 23. These batter boards provide a way to set the elevation of the top surface of the floor slab accurately and to align horizontally the edge form boards for the slab so that essential layout measurements are not disturbed in the process.

### BATTER BOARDS

Batter boards are needed at each of the four corners of the shelter. These permit side forms for the floor slab to be set at the correct height so that the slab, when poured, has a level to top surface. They also help to insure that the squareness of the slab, which was established earlier, will be preserved when the corner stakes are removed to permit installation of the edge form boards.

The batter boards are positioned a few inches outside the corners of the floor slab and consist of short length of lumber staked to the ground. String lines stretched taut across the batter boards along the four sides define the slab edges. When the string line at each edge is set to the correct height of the slab top surface, edge forms are placed in alignment with the strings and with their top ends even with the top edges of the form boards to provide a level slab. The batter boards may be removed any time after the slab edge forms are firmly positioned. However, it probably is best to wait until just before the concrete is poured in case edge forms are disturbed during other construction work that still must be done before the pouring is begun.

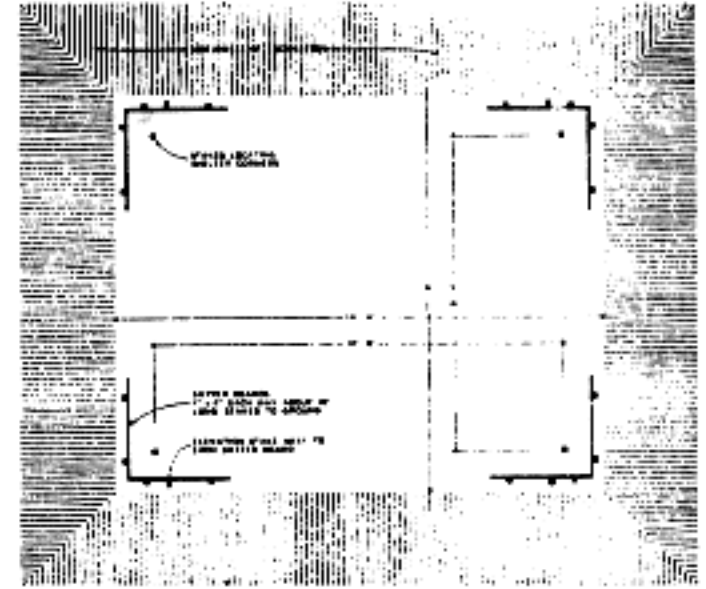

Figure 23. Plan layout for placing batter boards

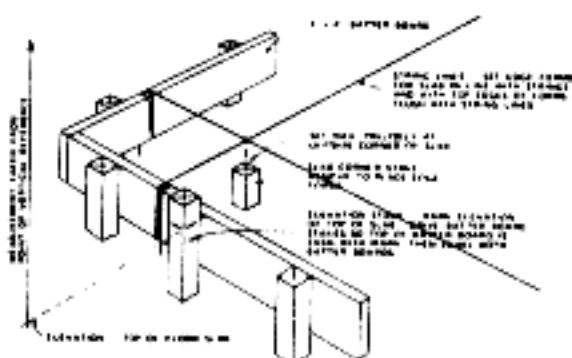

Figure 24. Construction of batter boards

## PLACING THE SLAB EDGE FORMS

To set the edge forms for pouring the concrete floor slab, nail four or five stakes to each of the two 2" X 4" cut to the length of the slab dimension for two opposite slab edges. Similarly, secure stakes to two 2" X 4" cut 3" longer than the slab dimension of the other two opposite sides of the slab. Set the inside faces of the 2" X 4" in alignment with the string lines, and drive the stakes so that the top surface of each 2" X 4" is level with the string line (be sure that the stakes are on the outside faces of the 2" X 4"). Nail the edge form boards together at their ends. The corners should be directly at the intersections of the string lines.

## THICKENED SLAB EDGES

To provide for thickened edges of the slab in lieu of footings, dig a trench 12" wide at the base and 6" deep all around the inside face of the form boards. Cut a similar trench at the location of the inside block wall next to the stair (see figure 30). Bevel the inside edges of the trenches at about 45 degrees. Remove the excess soil from the excavation area, and smooth the bottoms of the trenches to uniform depth.

### STEP 1 BY STEP PROCEDURE CONSTRUCTING THE BATTER BOARDS

**Step 1.** Place a pair of 1" X 4" boards about 4 ft. long at each corner of the shelter. Position the boards at right angles to each other about 1 ft. beyond the corner stakes, as shown in Figure 23. Nail these boards to supporting stakes, as shown in Figure 24. The batter boards need not be set exactly at right angles, since they are only temporary and their purpose does not require such accuracy. The height of the top edges of the batter boards above the bottom of the excavated area should be set approximately at the height for the top surface of the floor slab. Precision for this work is not necessary at this time, for the heights will be adjusted in the next step.

**Step 2.** To set the heights of the batter boards, first place a stake just outside each batter board near the corners, as indicated in Figure 24. Drive each stake to a level slightly higher than the elevation of the top of the slab. Using a transit level or water filled hose, mark on the stake at each corner the correct height of the surface of the floor slab relative to the point of vertical reference. Adjust each batter board up or down so that its top edge is even with the mark on the stake. Then use a carpenter's level to set each segment of the batter boards to the same height and level along its length.

**Step 3.** It is desirable at this point in the work to check that the batter boards at the four corners are set at the same height. A transit level or water filled hose can be used to make this check. Use one of the four batter boards as the base elevation, and verify that the other three are at the same height. Adjust the other three batter boards up or down as necessary to make all the same height.

**Step 4.** To set the lines of string that will serve as guides for placing the edge forms of the floor slab, stretch string along each pair of corner stakes (the stakes set previously which locate the corners of the floor slab), extend the string at each end across the top edges of the batter boards as shown in Figure 24. The string crossing the top edges of the batter board, aligned with the pairs of slab corner stakes and pulled taut, this will set the line and the height of the floor slab edges. The slab corner stakes now may be removed to clear the way for forming the floor slab.

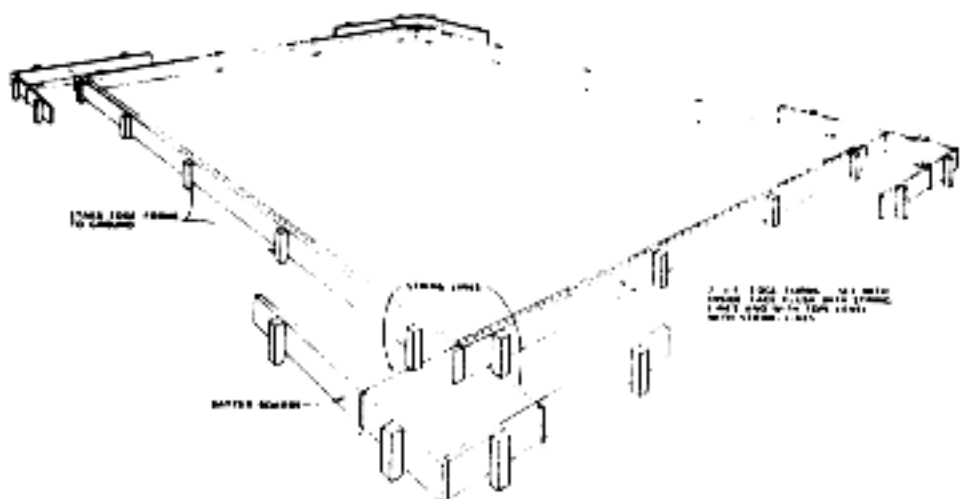

Figure 25. Placement of edge forms for floor slab

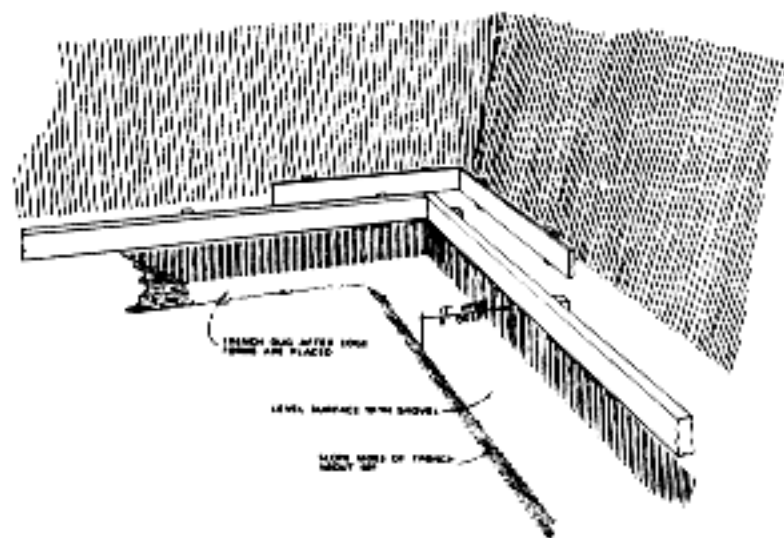

Figure 26. Trench for the thickened slab edges



## **FINISH GRADE BEFORE POURING THE SLAB**

To insure that the ground surface under the slab will be in form level, first remove loose soil by hand shovel and smoothen to the eye. Then screed the surface using a 2" X 4" about 9 ft. long and straight (not warped or bowed), dragging it across the surface from one edge of the slab area to the opposite side. Remove excess soil from high spots and any loose soil with a flat nosed shovel. An alternative method, in which short lengths of steel reinforcing bars are used to set screed elevations at interior points of large slabs, is not necessary here. Do not add fill dirt at low spots unless the fill can be compacted with a power tamper. Just plan on filling the low spots with concrete. Bracing of edge forms should not be necessary for the 4" thick slab to be poured. However, the stakes holding the edge forms in place should be firmly and rigidly set. If there is any chance that the edge forms appear loose, brace them using short lengths of 1" X 4" boards, with one end nailed to the top edge of the form board and the other end nailed to a stake driven outside the slab perimeter.

## **UTILITIES IN THE FLOOR SLAB**

Floor drains inside the shelter, or any other piping in the floor slab must be roughed in before the slab is poured. Water supply lines and electrical conduit which may be wanted by the homeowner are the sorts of piping that may need to be placed. This piping is run through the walls of the example shelter and so need not be dealt with at this time. The illustrated shelter utilizes a sump and sump pump for drainage rather than an underground drain line connected to a floor drain. It is assumed for the example shelter that the level of the floor slab lies below the level of the drainage lines serving the residence, and so an independent drainage system needs to be provided. A floor drain could be used in lieu of a sump if provision is made for the water to be drained away from the shelter.

The sump for the example facility is simply a concrete pit into which water within the shelter will drain and then be pumped out as required. Discharge piping and electrical power for the sump pump will need to be provided inside the space at a later time during the construction work.

The sump is a pit in the floor slab measuring 12" to 15" each way and 15" to 18" deep. The sump pit is formed by digging an oversized hole in the correct location and to the desired depth below the level of the floor slab. A plywood form, sized for the pit opening, is placed in the hole after a concrete base of the pit is poured (as shown in Figure 28) but before the floor slab concrete is poured. Concrete then is poured around the sump form at the same time the floor slab is poured. When the form for the sump is removed, a concrete lined pit is created into which a sump pump can be placed. Details for construction of the sump are shown in Figures 27, 28, and 29.

### **STEP ● BY ● STEP ● PROCEDURES**

#### **CONSTRUCTING THE SUMP**

**Step 1.** Dig a hole about 4" larger on each side than the finished size of the sump pit at its base, with the side walls of the hole as nearly vertical as possible. Dig the pit to a depth of 4" deeper than the depth to the finished surface of the sump below the top surface of the floor slab.

**Step 2.** Pour a concrete pad about 4" thick at the bottom of the hole so that the top surface of the pad is at the intended depth of the sump pit. Install a keyway in the wet concrete which is continuous around the four sides of the pad and is positioned as shown in Figure 28. The keyway will provide a bond for the concrete side walls of the sump which will be poured with the floor slab. Trowel the top surface of the freshly poured pad to a smooth surface. The key way may be formed with a length of 1" X 2" with beveled sides (the beveled sides make removal of the keyway easier after the concrete has set up).

**Step 3.** Construct and install the form for the sump, as indicated in Figure 29. The sump form must be constructed in a manner that allows its removal after the concrete has set up. The top of the sump form should be set 1/2" lower than the top edge of the floor slab edge forms. The floor slab, when poured and screeded, then will have a positive sloop for drainage into the pit.

**Step 4.** Cut the wire fabric reinforcement and dampproofing or waterproofing membrane diagonally across the corners of the sump form and fold each down around the edges of the hole as is indicated in Figure 28. If a waterproofing membrane is used any cut edges must be sealed to make the membrane watertight (see Section 7 for a discussion of waterproofing membranes).

**Step 5.** Pour the concrete side walls of the sump at the same time the floor slab is poured. It may be necessary to stake the sump form in place from the inside face, for the form will tend to float upward in the wet concrete.

## FLOOR SLAB REINFORCEMENT STEEL

Cut and place reinforcement steel of proper size and length for the floor slab as indicated in Figure 30 and 32. A hacksaw is suitable for the small amount of cutting involved. Although, a chop saw is made especially for this task.

Before any reinforcement steel is set in place, remove all loose rust using a wire brush. Reinforcement steel stockpiled at the work site for any extended time is likely to rust, and this can affect the concrete to steel bond. Do not oil or grease the reinforcement steel to stop the rusting, because this also will affect the bond, these comments pertain to all reinforcement steel used in the construction work, including the bars for the floor slab now being discussed and the bars for walls and roof slab that are to be constructed later.

## FOOTING BARS

Place two No.4 steel bars at the bottom of each footing trench (8 bars total at the perimeter and 2 bars at the location of the inside wall), overlapping bars at the corners as shown in Figure 30. Position the bars about 3" above the bottom of the trenches. Pieces of brick may be used to support the bars. Even better, because they hold the bars in place when the concrete is poured, short lengths of steel bars may be driven about 3 ft. apart for each length of trench reinforcement and wired firmly to the horizontal bars.

No. 16 tie wire (a soft annealed wire) should be used for all wired connections of reinforcement steel. For example shelter, pieces of tie wire looped around intersecting bars and with the ends twisted together is sufficient.

## SLAB TO WALL DOWELS

Dowels cut from No. 4 bars are placed at the slab edges around the entire perimeter, as indicated in Figure 31. These dowels are for securing vertical reinforcement bars that are placed in the masonry block walls later. Cut the dowels to the length indicated and bend to 90 degrees so that each leg is the dimension indicated in Figure 32.

The dowels are to be positioned in plan so that the vertical legs match the locations of vertical reinforcement bars in the walls. Correct placement requires careful planning and workmanship. The dowels shown in Figure 32 are positioned to correspond with the particular type of block selected for the example shelter and with the position of the cells of the block units. If some other type of masonry block is used for the walls, then modify the locations of the dowels to fit the cells of the substitute block units.

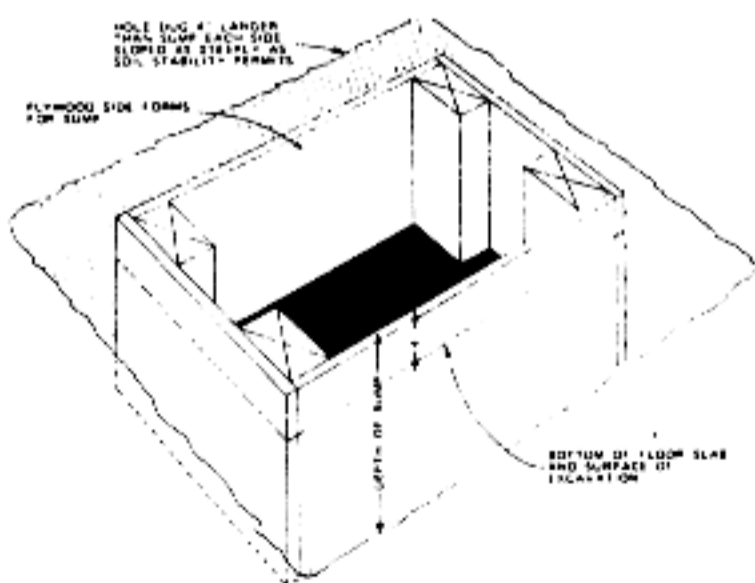

Figure 27. Excavation and forming of the sump

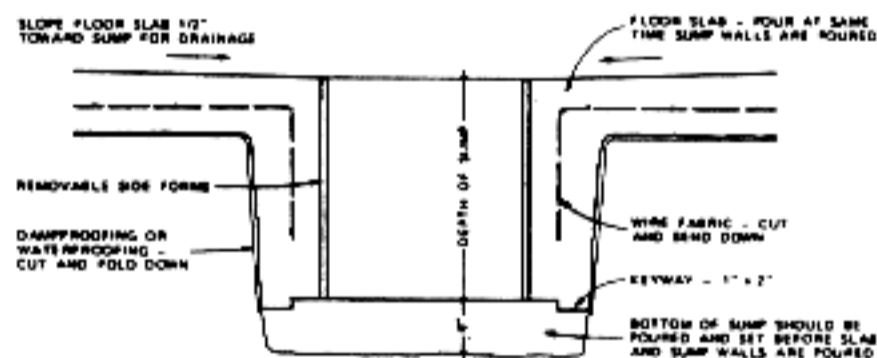

Figure 28. Cross section through the sump

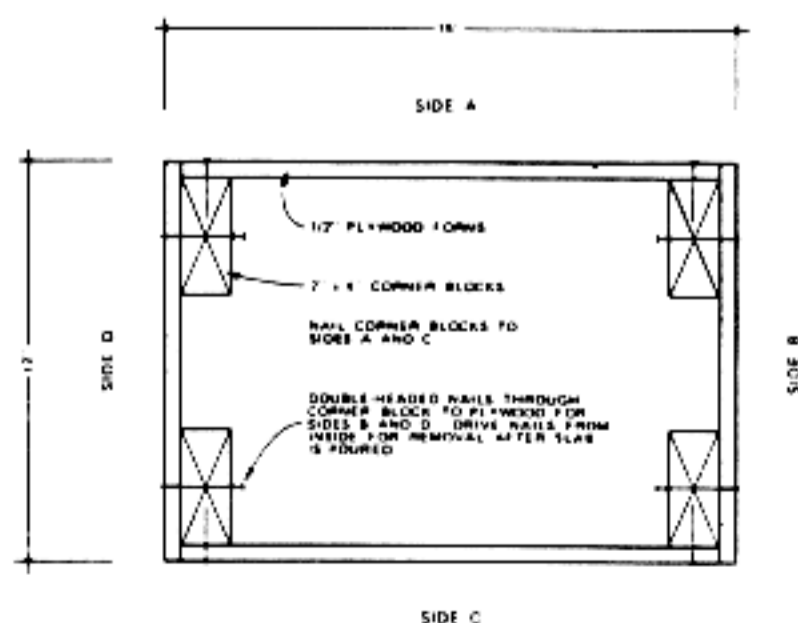

Figure 29. Construction of removable forms for the sump

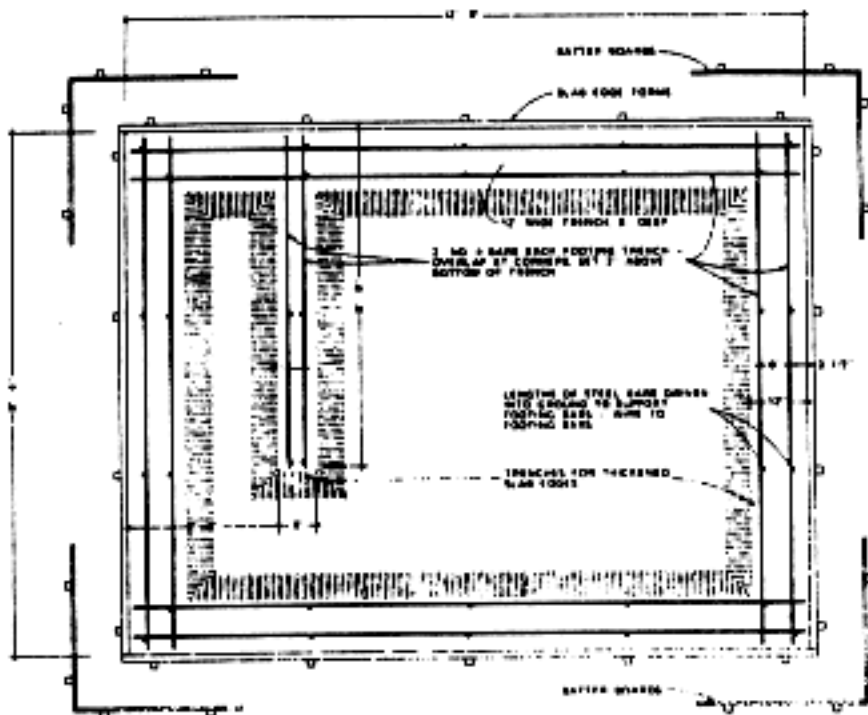

Figure 30. Reinforcement steel for slab footing

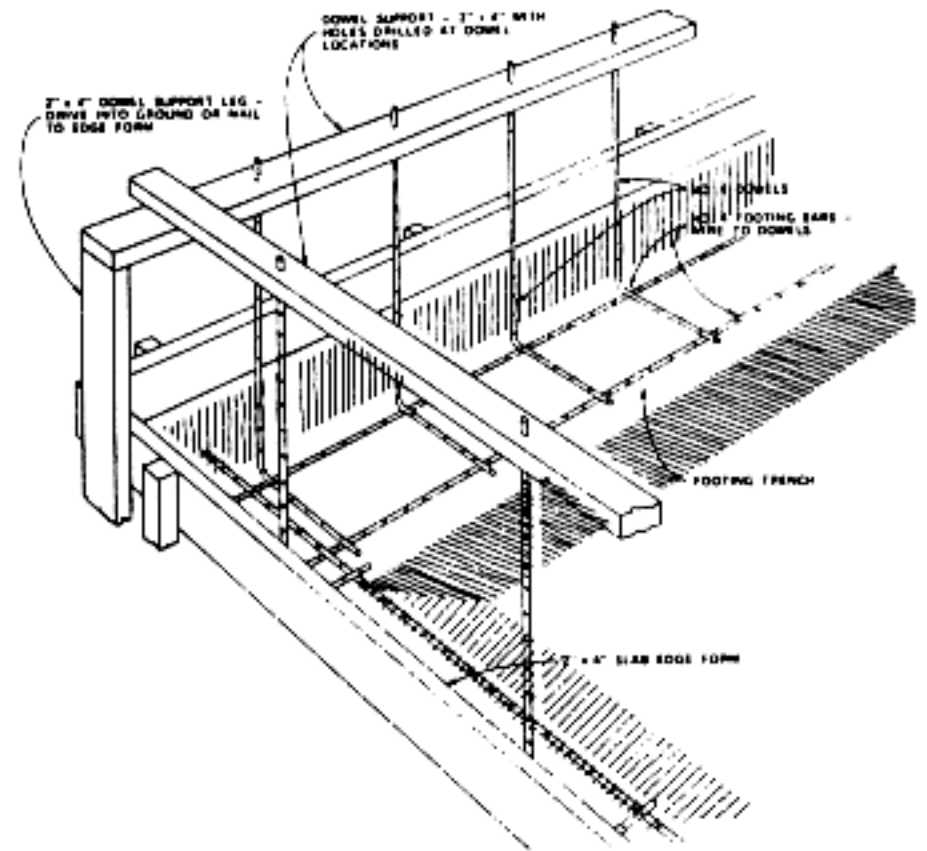

Figure 33. Placement of reinforcement steel in the slab footing

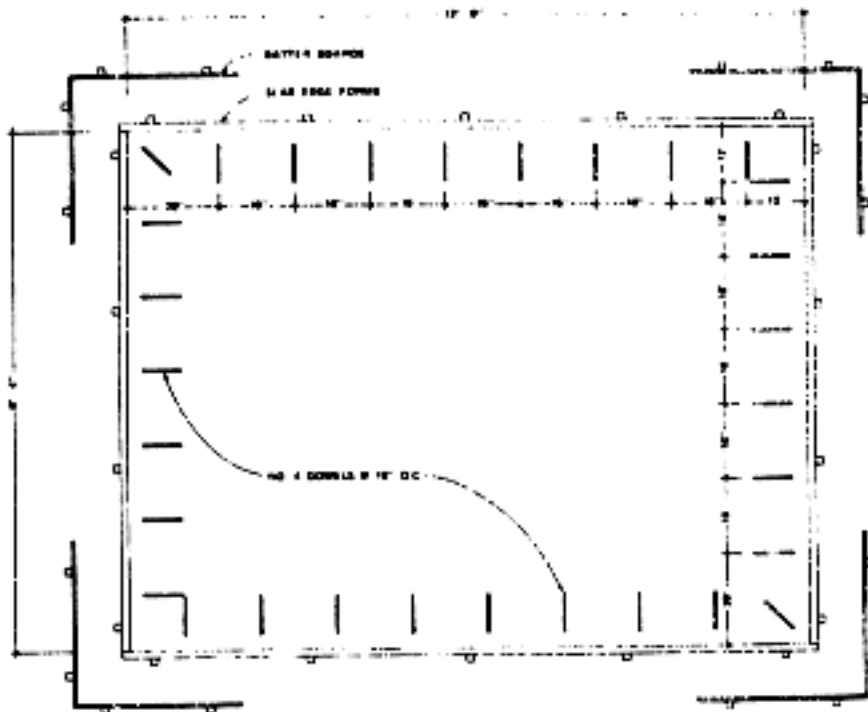

Figure 31. Locations of dowels to be placed in the floor slab

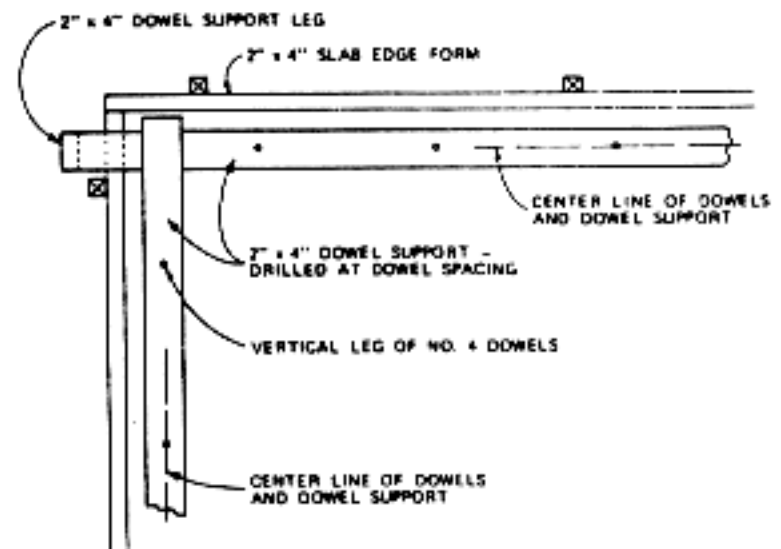

Figure 34. Plan diagram of support for the slab to wall dowels

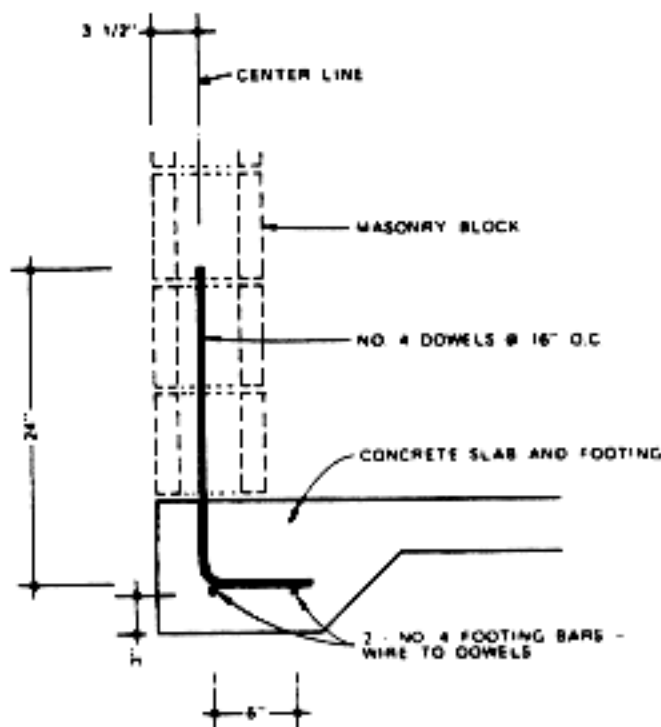

Figure 32. Details for placement of slab to wall dowels

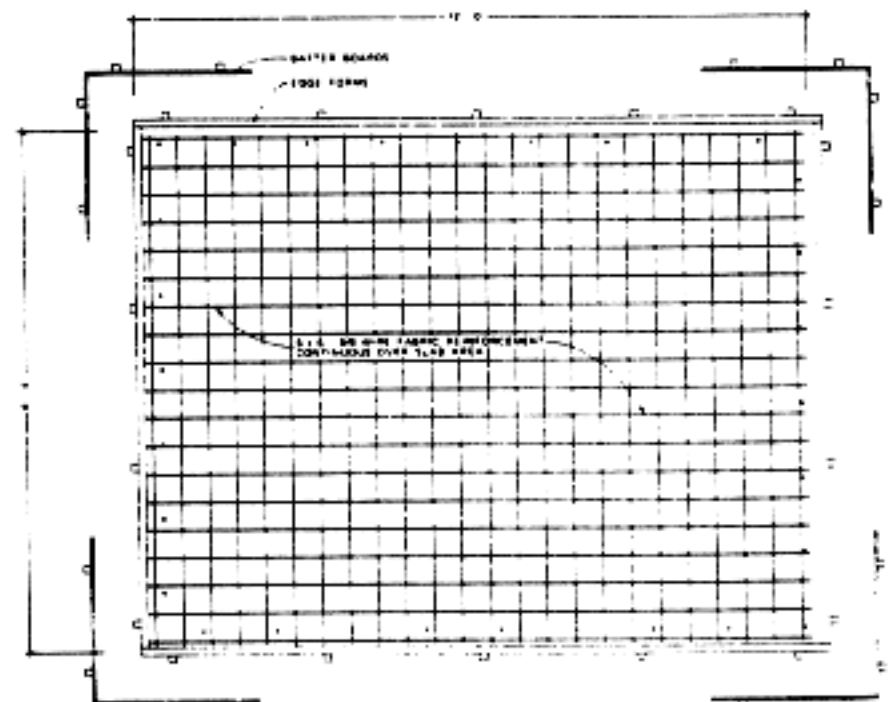

Figure 35. Placement of wire fabric reinforcement in the floor slab



The horizontal legs of the dowels should be wired securely to the two No.4 bars in the footings. It takes a little more effort to position the vertical legs. The vertical legs will tend to move out of position when the concrete is poured if they are not secured in place. The most reliable way to firmly secure the dowels in position is shown in Figures 33 and 34.

### WIRE FABRIC SLAB REINFORCEMENT

Wire fabric reinforcement is placed over the entire slab area as indicated in Figure 35. Wire fabric reinforcement is available in various wire gages and various spacing of the grid or mesh. The fabric specified here is a No. 8 wire in each direction, spaced to form a grid measuring 6" X 6" - 8/8.

Cut the wire fabric about 2" shorter (1" each side) than the slab dimension each way. Position the wire fabric about mid height of the 4" slab, i. e., about 2" above the soil surface. Lap the wire fabric 6" minimum if more than one piece is needed. Support the wire fabric on a piece of brick laid flat on the dampproofing or waterproofing membrane (see Section 7 for a discussion of these membranes). Remove the supports as the concrete is poured.

### CONCRETE FOR THE FLOOR SLAB

The first step in placing the concrete floor slab is to order (or mix) concrete of the correct strength. In general, concrete strength is determined by its cement content and the amount of water added in the mixing process. For the floor slab of this shelter, concrete strength of 2,500 pounds per square inch (PSI) compressive strength is specified.

If ready mix concrete is ordered, one usually needs only to indicate the concrete strength required for the job and the quantity (in cubic yards or fractions thereof). Sometimes the concrete is ordered by the number of bags of cement in the mix. A five bag mix will provide the desired 2,500 psi concrete.

Concrete normally is ordered by the cubic yard. The quantity required for the floor slab of the example shelter is slightly less than 2.6 cu. yds. (determined by multiplying the area of the slab by its thickness measured in feet and dividing by 27, plus an allowance for the thickened edges, the side walls of the sump and some waste). An order for 2 3/4 yards should be placed.

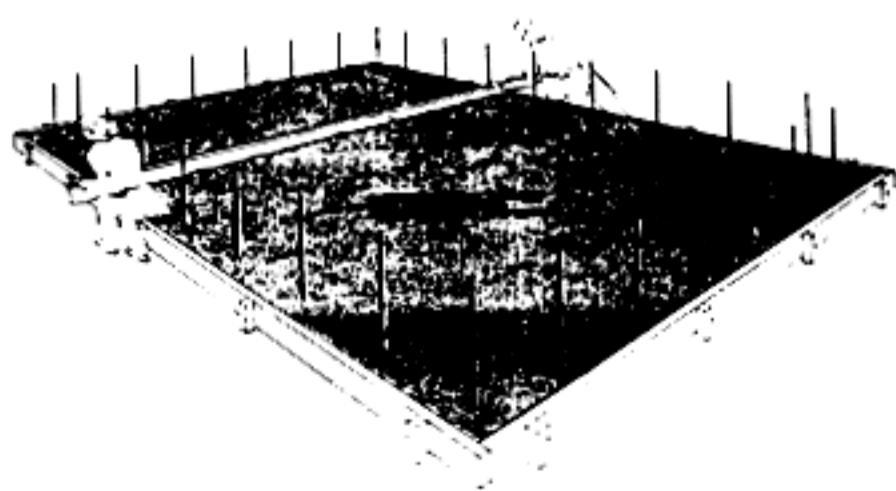

Figure 36. Screeding techniques for flat concrete surfaces

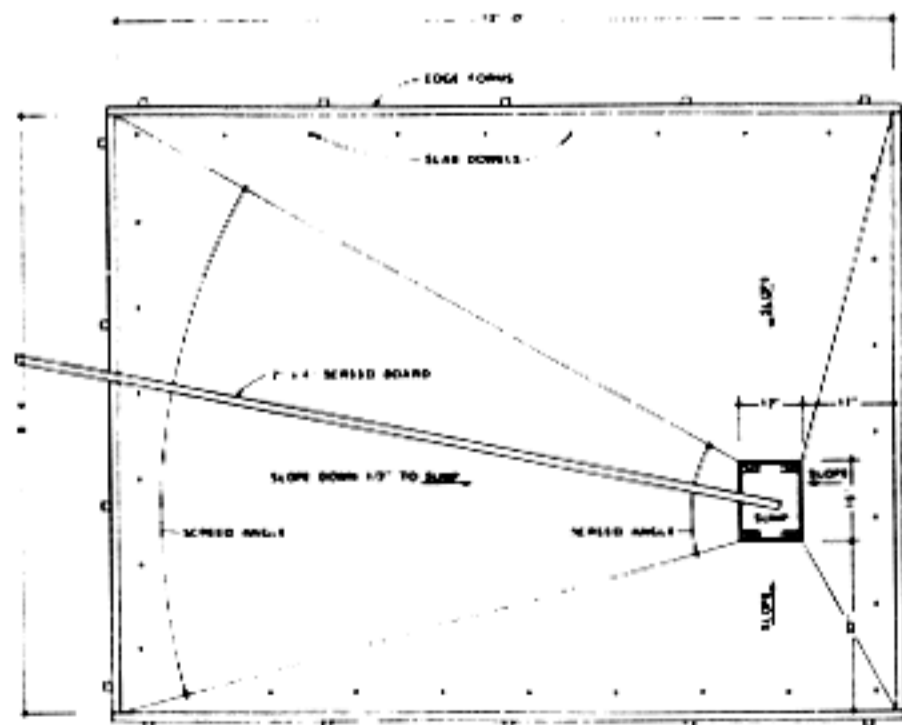

Figure 37. Screeding techniques to provide drainage slope for slabs

---

If the concrete is to be mixed at the building site, the proportions of cement, sand and gravel to provide the 2,500 psi concrete strength typically will be:

**Cement - 1 part    ⌘    Sand - 2 parts    ⌘    Gravel - 3 parts**

Proportions of sand and gravel may need to be varied from that indicated if the gravel aggregate is not well graded, i.e., if there is not a good mix of fine to coarse gravel. If, for example, the gravel is mostly coarse (3/4" maximum in any case), then the ratio of sand should be increased so that the proportions are closer to 1:1 for sand and gravel.

When water is added in the mixing process, the normal tendency of most workmen is to add too much, usually because the mixing and pouring tasks are much easier when the concrete is sloppy. However, concrete that is mixed too wet will have greatly reduced strength. Hence, the amount of water added should be kept as small as possible and yet not so little that the concrete is too stiff to be worked. There can be no rule as to the correct amount of water to be added, because the wetness of the aggregate can vary so greatly. In general, only enough water should be added so that the aggregate and cement mix thoroughly together and so that the mixed concrete, when poured must be tamped into place rather than flowing into place. Generally speaking, if the concrete flows, then it is too wet; if it does not readily tamp into place, then it is too dry, and more water should be added to the mix. A guide: if the concrete mixes too quickly or too easily, then it probably is too wet.

### ***PLACING THE CONCRETE***

When placing the concrete, use a tamper (a length of 2" X 4" boards will do) so that the concrete completely fills the footing trenches and so that voids and pockets of air are absent. Distribute the concrete over the work area with a shovel as it is poured from the ready-mix truck or wheelbarrow, starting at one corner or at the center of the slab area.

As the placement of the concrete proceeds, constantly check that the wire fabric reinforcement and steel bars remain in their correct positions. The weight of the concrete may tend to push the wire fabric down and to displace the bars sideways. If this occurs, pull the fabric upward in the correct position in the center of the slab thickness or pull the bars back into position using a piece of bar with a hooked end. It is best for the small slab area involved to avoid walking on the exposed wire fabric during the pouring phase so that it is not pushed out of position.

As the placement of the concrete nears completion, and before any setting up of the concrete occurs, screed the surface, guiding a length of 2" X 4", cut slightly longer than the width of the slab, on edge across the top surface of the edge forms (see Figure 36). Alternatively, screed the slab for the drainage slope toward the sump, as indicated in Figure 37.

After screeding, smoothen the slab surface with a wood float. The concrete now is ready for finishing. When the concrete is set hard enough carry a workman's weight but still soft enough so that the surface can be worked (typically an hour or so after the pour), finish the surface using a steel trowel. This last step provides the highly smooth surface that one sees on walks and slabs.

Edge forms and sump form can be removed after the concrete has set up for about 24 hours.

### ***CURING THE CONCRETE***

To properly cure the concrete, cover the slab surface with a sheet of polyethylene film (4 mil thickness is adequate) after the concrete has set up for a few hours. If the weather is warm to hot, occasionally sprinkle the hardened surface of the slab with water and replace the cover. This should be left in place from 4 to 7 days.

The curing process will help the concrete slab to develop its strength before the construction work is continued. Chipped edges and scars on the slab surface may result if sufficient curing time is not allowed.

Construction of masonry block walls for the home shelter is described in this section. The work including the following tasks.

- ① Layout work and establishing coursing height controls for the masonry.
- ② Laying the corner blocks.
- ③ Laying the infill blocks between corners.
- ④ Placement of sleeves for piping and conduit passing through the walls
- ⑤ Placement of reinforcement steel.
- ⑥ Placement of grout in cells of the block.

### LAYOUT OF MASONRY WORK

Before beginning any laying of masonry, certain planning steps and layout work are essential in order to achieve a properly constructed wall. The end objective for the masonry work so that horizontal and vertical block course fit the planned dimensions of the shelter (remember, the shelter size was selected to fit the modular size of the block units), and to erect walls that are straight and with square corners. To do the layout work the block units selected for the facility should be on hand so that actual block dimensions can be used in the layout work.

Horizontal coursing for the example shelter is indicated in the plans shown in Figure 5 and 7. A safe way to proceed is to set the first layer of block in place dry without mortar for the entire group of walls. This will permit direct determination of the width of mortar head joints to be used when the laying begins. Space the blocks equally, and mark the joint locations and widths on the slab where they will be visible when the mortar is placed. Joints should be  $3/8"$  to  $1/2"$  thick.

To establish the vertical coursing height of each layer of block, a coursing rod is used. On a length of 2" X 2" or 1" X 2" which is cut slightly longer than the full height of the wall, mark each block height and bed joint thickness along the full length of the coursing rod and for the full height of the wall. The first block course will be set on a bed of mortar, so the first mark at the bottom of the coursing rod should be the thickness of a mortar joint. Then a block height is marked, another bed joint, and so on.

To obtain uniform coursing height for the block, subtract from the total height of the wall the dimensions of all blocks that make up the wall height (for the example shelter, 10 blocks times  $7\ 5/8"$ ) and divide the remainder by the number of bed joints in the wall counting vertically (10 joints for the example facility). This will give the exact thickness of each mortar bed joint.

In the event that the four corners of the floor slab are not exactly at the same elevation (perhaps due to lack of accuracy when slab elevations were set before it was poured), the lowest mortar bed may be used to achieve level coursing of the block. In such a case, select as the thickness for the first bed joint the difference between the higher slab elevation and lower elevation, and use that dimension plus  $3/8"$ . This assumes that the difference between high and low elevations is less than an inch. Greater differences will need to be made up in the second or third bed joints so that any one mortar bed is not greater than about  $1\ 1/4"$ . To get the precise thickness of the remaining bed joints counted vertically, subtract the dimension of the oversized joints (the sum) from the value determined in the previous paragraph, and divide the remainder by the remaining number of joints. The coursing rod should be marked accordingly.

The coursing rod will be used throughout the masonry work, including the shelter walls and planter walls, to control the height of coursing for each layer of block masonry. The same rod also can be used for brick work, since brick coursing also will be modular with block units (3 brick course per block course).

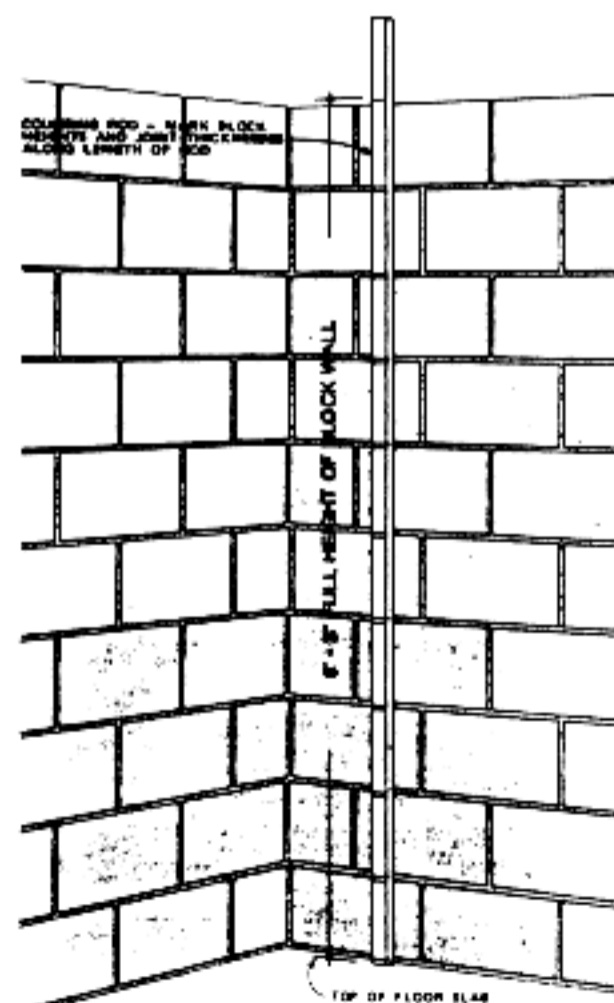

Figure 38. Preparation of a coursing rod



**MORTAR**

Selection of the type of mortar and its mixture for laying up the masonry walls is a relatively straight forward task, but mixing of the mortar entails hard work unless one has a power mixer.

As with concrete, mortar strength is determined by the proportions of cement, hydrated lime or lime putty, sand aggregate and water used in the mix. The proportions of the mix must be controlled carefully so that the resulting mortar strength and durability are as required and expected.

Mortar is classified as Type M, Type N, Type S, etc., according to the proportions of cement in the mix. Each type of mortar has similar ingredients but in different proportions and, hence, somewhat different characteristics of strength and durability. The basic difference among the types is in the amount of hydrated lime or lime putty and in smaller quantity than is used in type N mortar. Lime makes the mortar easier to work with but also tends to make the mortar less durable. Too much lime in the mix will result in poor mortar strength and durability.

Type S mortar should be used for the example facility. Type N mortar is used for normal masonry work, but Type M or Type S mortar is required for reinforced masonry construction as is specified for the example shelter. Type S mortar uses a specially hydrated lime in smaller quantity than is used in Type N mortar. Proportions of the mix for Type S mortar are given in Table 3.

Aggregate for the mortar may be natural sand or manufactured sand. The amount of water to be added to the mix will depend upon the dampness of the aggregate and whether hydrated lime or lime putty is used. In general the mix should be plastic but stiff i.e., workable, not so it will flow.

Dry mortar mix (pre-mix) of Type S can be purchased by the bag. However, pre-mix mortar still must be mixed with water before it is used. Pre-mix is not likely to be economical for the task at hand, due to the amount of mortar that will be required for the job. A less costly solution is to purchase the ingredients separately and then prepare the mix at the job site.

A drum mixer is almost essential for the masonry work. Although hand mixing of the mortar is possible, it would entail considerable effort to prepare the amount required for this project.

TABLE 3			
MIX PROPORTIONS FOR TYPE S MORTAR			
Portland cement	1 part	Masonry cement	1 part
Hydrated lime	1/4 to 1/2 part	Aggregate (sand)	2 1/4 to 3 parts

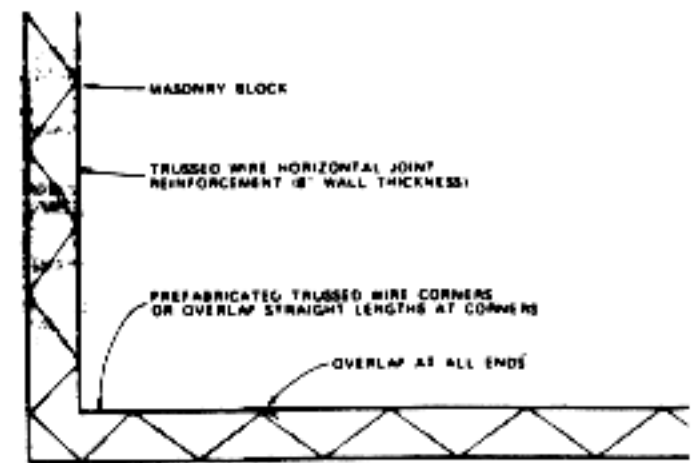

Figure 39. Placement of reinforcement in masonry wall

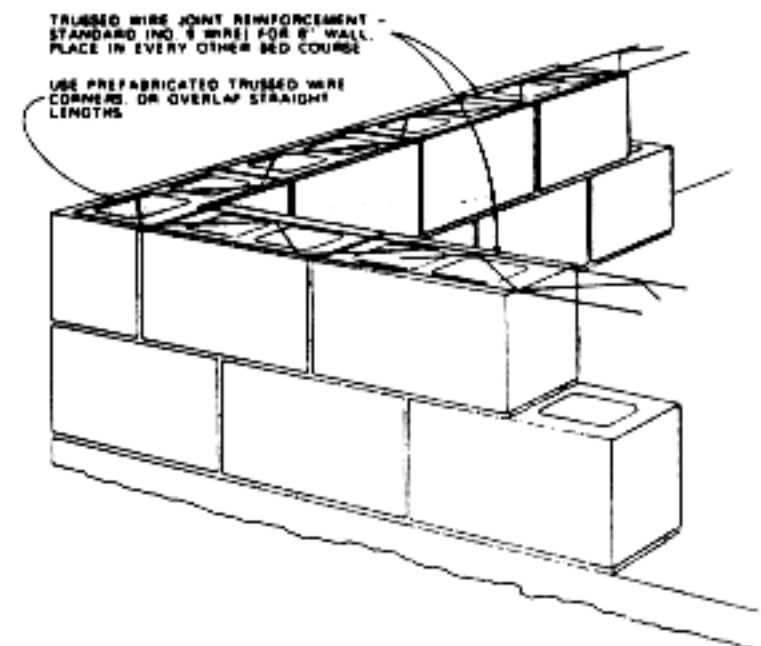

Figure 40. Placement of horizontal joint reinforcement

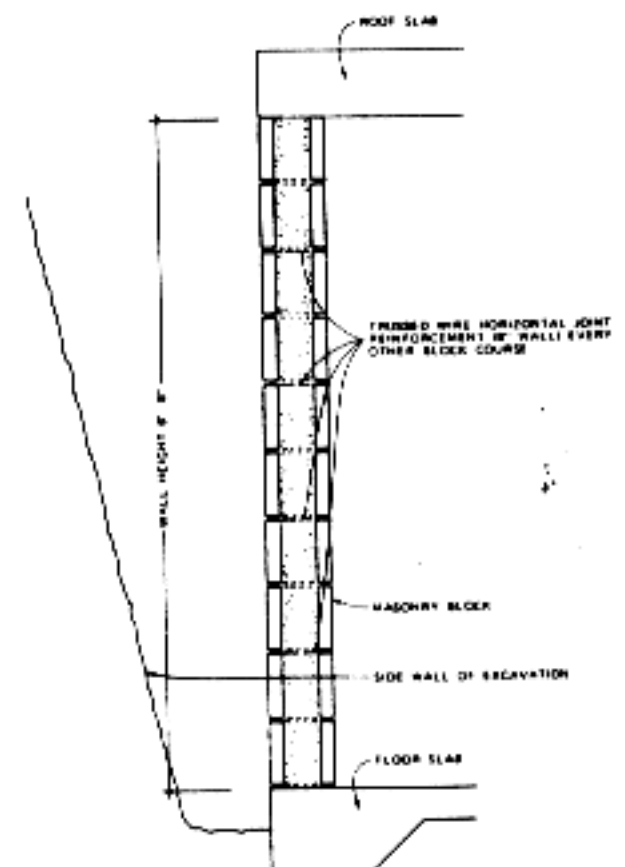

Figure 41. Shows location of horizontal joint reinforcement

## MASONRY WALL REINFORCEMENT

Masonry block walls of the example shelter will be subject to horizontal (lateral) forces from the surrounding soil after backfilling is completed and the structure is buried. Since unit masonry does not resist well these lateral forces that are perpendicular to the plane of the wall surface, the construction is strengthened by means of reinforcement steel that is placed in the walls.

Two types of reinforcement are provided in the masonry walls: 1 Horizontal reinforcement laid in the bed joints on alternate blocks course, and 2 Vertical reinforcement bars which are wired to dowels placed earlier in the floor slab and which extend above the wall where they will be secured later to the roof slab reinforcement steel.

Horizontal reinforcement is laid continuously along the walls in every other bed course, as is indicated in Figure 41. Mortar is then placed in the horizontal bed to surround the reinforcement. The reinforcement should be lapped at all ends and corners. Prefabricated corners are available in the product line and provide an alternative to lapped corners.

Vertical reinforcement for the walls of the example structure consists of No. 4 steel bars spaced so that they occur within the cells of the block units at 8" on center i.e., two bars per block unit (see figure 5).

Half of the vertical bars (16" o.c.) should align with and be wired securely to the dowels placed earlier in the floor slab. The other half (also 16" on center) are extended 16" above the tops of the walls. These will be bent over later and wired to the reinforcement steel to be placed in the roof slab. For walls around the hatchway, steel bars at 16" o.c. extend 28" above the walls and are left straight to provide reinforcement for the hatchway enclosure walls placed above the roof slab

Vertical reinforcement poses an inconvenience for the masonry work in that the block units must be threaded over the bars as the masonry work proceeds. Although it would be more convenient to drop the vertical bars into the block cells at a later time, this would defeat the purpose of the reinforcement, because then there would be no way to wire the bars to the dowels after the blocks are in place. Also, the block cells could not be kept clean of mortar spillage as is required for the grouting work. Two alternatives for placement of vertical reinforcement in the block walls are indicated in Figures 42 and 43.

### ALTERNATIVE ①

Use two pieces of vertical bar for each cell, each slightly longer than one half the height of the walls, as is shown in the figure. By wiring the lower bars to the dowels first, unit masonry can be threaded onto the shorter bars more easily. When the lower block courses reach a height about 12' below the top ends of the lower bars, the upper bars then can be spliced (wired) to the lower bars, and the upper block courses can be threaded into place.

This alternative has the advantage of greater convenience for placement of the masonry units and the disadvantage that more reinforcement steel is needed. Lengths of trussed wire horizontal joint reinforcements must be threaded down the vertical bars at alternate blocks courses for either alternative 1 or alternative 2.

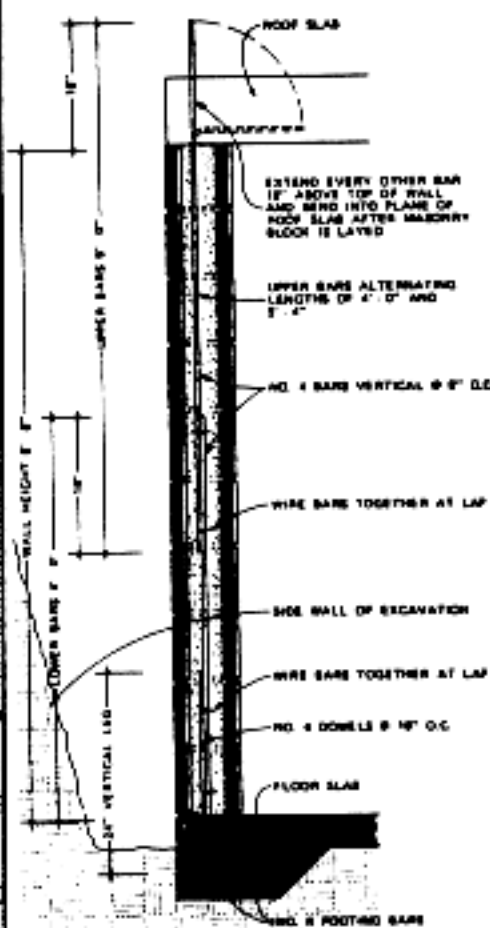

Figure 42.

### ALTERNATIVE ②

Use a single length of vertical bar of full height for each cell as required for the wall, and thread the masonry units down the full height of the bars. Bars aligned with dowels are wired to the dowels as for alternative 1.

This alternative has the advantages that placement of the vertical steel involves fewer construction steps and that the least possible amount of reinforcement steel is required. A disadvantage is that masonry units must be lifted more than 9 ft. above the slab to thread them over the vertical bars. Alternative 2 therefore would require scaffolding from which to work commencing at the outset of the masonry work; whereas scaffolding for alternative 1 normally would be needed only for the upper 4 ft. of wall.

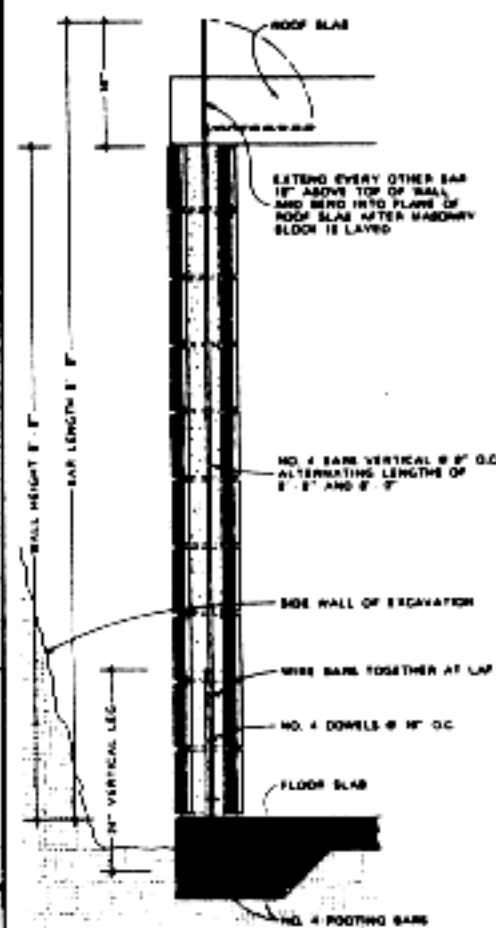

Figure 43.

## LAYING THE CORNER BLOCKS

Laying of masonry blocks units can commence once the vertical steel that fastens to the dowels is in place, horizontal joint reinforcement is at the job site ready for use as needed, and the mortar is ready to mix. Work should begin at the corners which is where the vertical coursing height is controlled.

The corners for each wall segment should be placed before infill blocks are placed along the length of the wall. The bottom mortar bed (or several beds) should be used to level the masonry walls so that the tops of blocks units at all the corners are at the same elevation. Corners should be laid up two or three courses, using the control rod to set each corner block and a level to align the corner and adjacent block units (see Figure 46).

Vertical reinforcement steel for the walls that is wired to the dowels needs to be in place when this work begins. Those vertical bars not secured to the dowels (the ones in between) can be dropped into the block cells before the first grouting operation is undertaken.

### STEP ● BY ● STEP ● PROCEDURE

#### GENERAL TIPS ON LAYING MASONRY

**Step 1.** Using a trowel, place a bed of mortar of the approximate thickness of the horizontal joint (bed joint) along all edges of the surface. Avoid using too much mortar so that the excess will not squeeze into the cells of the block where it is difficult to remove from the in place wall.

**Step 2.** Place mortar on the end face of the block unit next to be laid, drawing the trowel across the edges of the block end, as indicated in Figure 45. This mortar will form the vertical joint (the head joint). The mortar consistency should be such that the mortar will stick to the surface of the masonry unit. It will help to keep the block units dampened during hot weather so that water in the mortar is not absorbed too quickly into the masonry material.

**Step 3.** Place the prepared block unit onto the mortar bed and tamp into position so that the height of the top of the block matches the elevation as determined from the control rod or mason's string.

**Step 4.** Using a carpenter's level, check the horizontal and vertical faces of the masonry unit repeatedly as it is tamped into place. An irregular wall surely will result if due care is not given to this step.

**Step 5.** Remove any excess mortar that may have squeezed out of the bed and head joints onto the faces of the masonry units or into the block cells, using the edge of the trowel for cutting. Care should be taken that excess mortar does not fall into the cells, because these cells must be clean for the grouting operation, as explained later.

**Step 6.** Joints on exposed surfaces of the freshly laid wall may be tooled if a sharper joint line is desired. Several types of special mason's tools are available for this purpose.

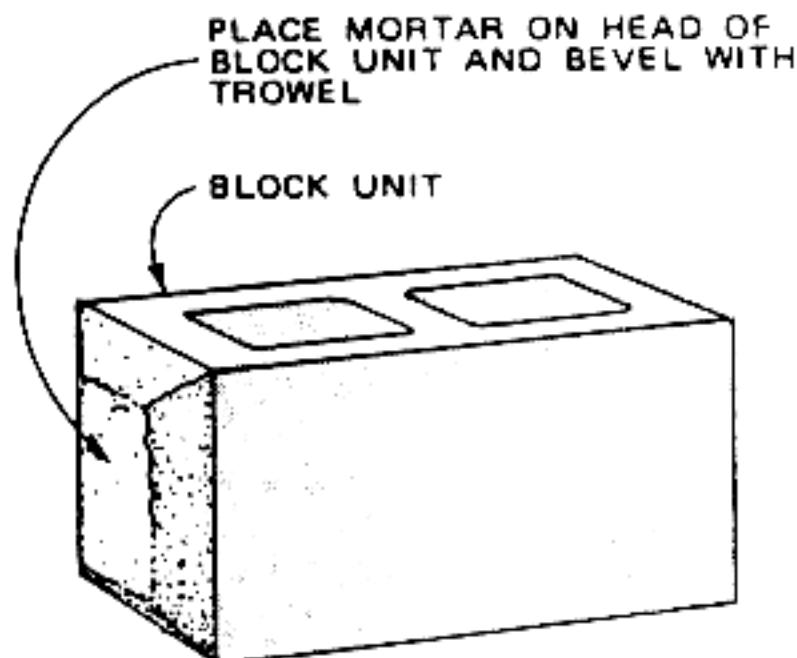

Figure 45. Placement of mortar on head of block unit



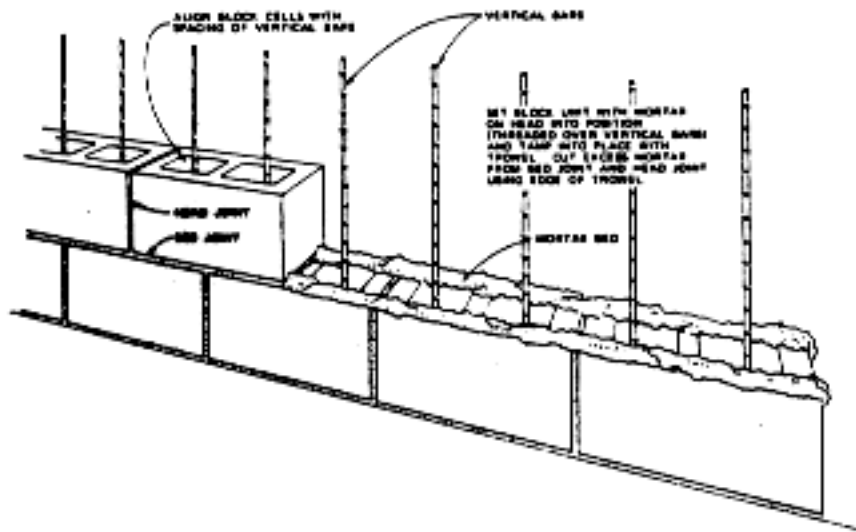

Figure 44. Placement of mortar for bed course of masonry walls

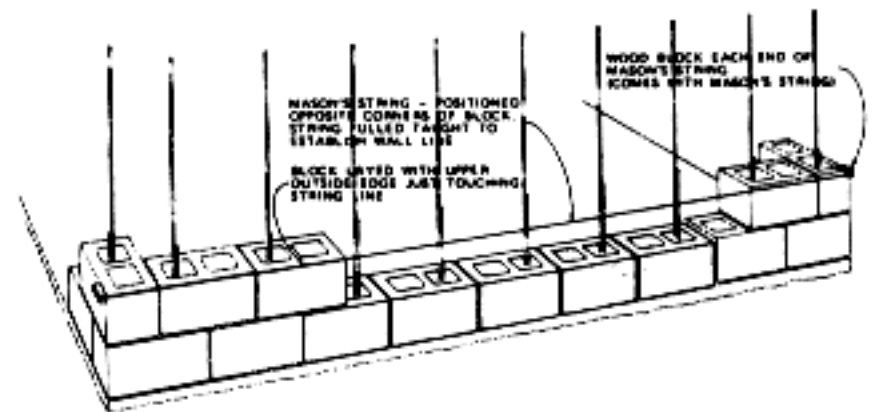

Figure 47. Infill block units in wall between corners

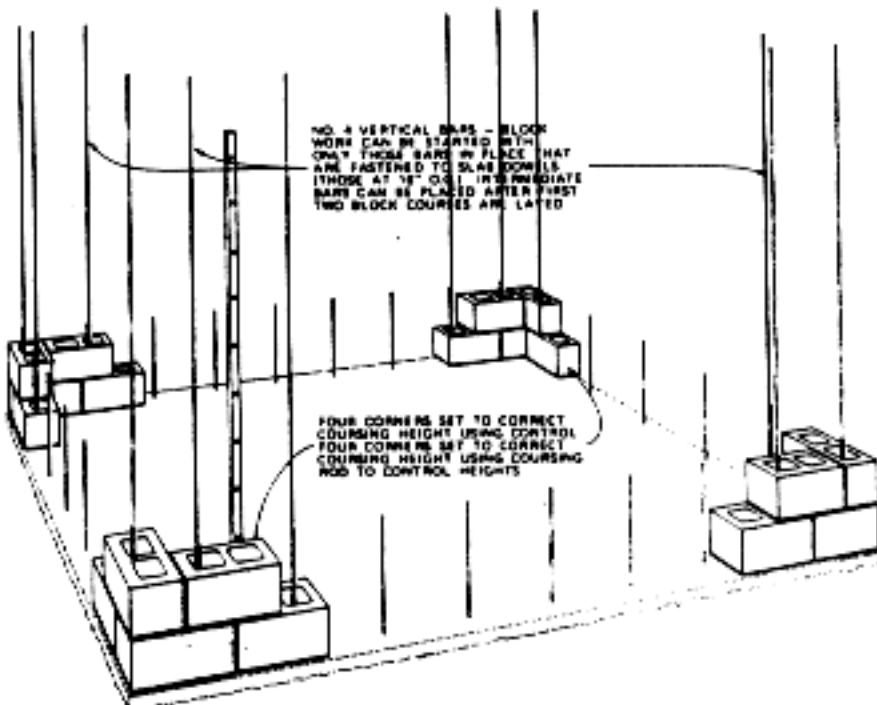

Figure 46. Corners of the shelter set for first two block courses

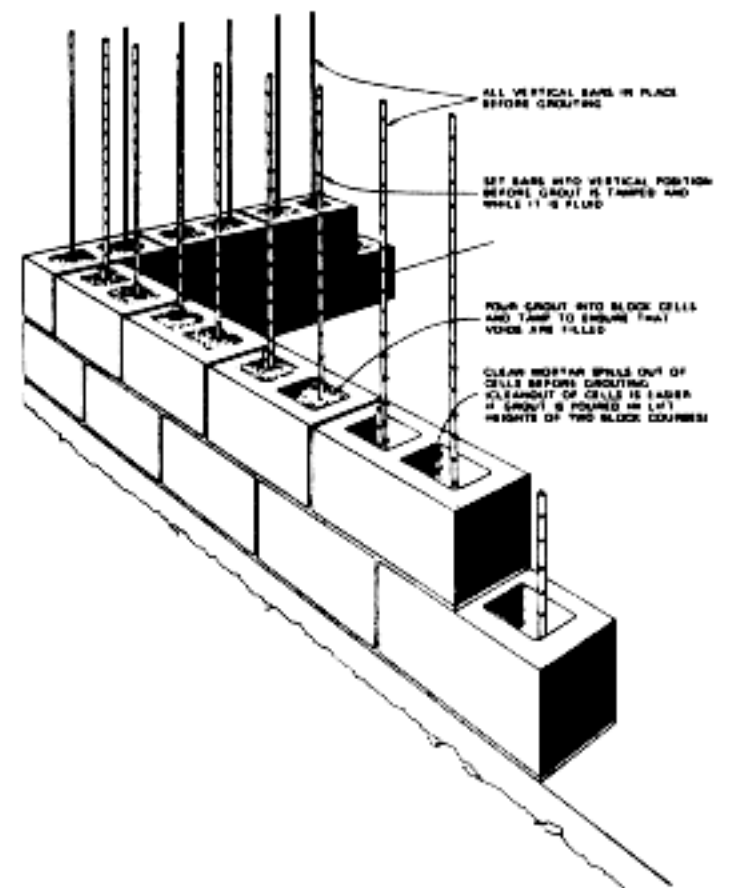

Figure 48. Placement of grout in cells of block units

## LAYING THE INFILL BLOCKS

Infill masonry block units for each wall segment can be laid accurately with the use of a mason's string which serves as a guide for level and straight coursing. A mason's string consists simply of two wood blocks connected by a string. They are available at most hardware stores. The wood blocks are placed, one at each corner of the wall segment to be infilled, at the height of the top of the masonry course to be laid, and with the string pulled taut to give a straight and level line. Infill blocks units are laid so that their top edges align with the string line. Note the importance of having set accurately the corner block units at this point in the work.

### INSIDE WALL

The inside wall (next to the stair) should be laid at the same time the perimeter walls are laid (not shown in Figure 46). This inside wall is reinforced with horizontal joint reinforcement at every second block course also and with No 4. vertical bars spaced at 16" o.c. Dowels are not needed to secure this steel to the floor slab. However, the block cells of the inside wall are to be filled with grout.

This wall adjacent to the stair is an essential part of the radiation shielding for the shelter. Its function is to protect shelter occupants against air-scattered radiation and against direct radiation from possible fallout material on the hatchway cover. Grout fill in the block cells increases the shielding effectiveness of the wall. An added benefit is that the wall also screens shelter occupants in tornado regions against wind blown debris that might penetrate the light hatchway cover.

Due to the importance of this wall to the protective purpose of the shelter, the homeowner / builder is cautioned that it should not be omitted.

### STEP ● BY ● STEP ● PROCEDURE

#### LAYING THE MASONRY WALLS

**Step 1.** Layout the spacing of masonry units in a plan drawing to establish thicknesses of vertical (head) joints, and place the lowermost course of masonry units into position dry to verify actual locations of joints and to insure that head joints thicknesses are uniform.

**Step 2.** After establishing vertical coursing heights of the masonry units, prepare a rod that will be used to control the coursing height and bed joint thicknesses as the work progresses. Check vertical elevations of corners of the floor slab, and if differences are found, modify bed joint thicknesses as needed so that the masonry is laid level.

**Step 3.** Cut vertical reinforcement bars to correct length, and wire them securely to dowels in the floor slab where dowels occur. Other reinforcement is installed as the work progresses.

**Step 4.** Determine ahead of time the sizes and locations of any pipes or conduit that must pass through the walls so that sleeves can be placed in the block units where required as they are laid.

**Step 5.** Lay corner masonry units up 2 to 3 courses at a time, threading the block units over the vertical steel bars as required, and placing horizontal joint reinforcement in every second bed course.

**Step 6.** Lay infill masonry units between the corners for each wall segment using a mason's string as a guide for straight coursing, threading the block units over vertical steel bars and placing horizontal joint reinforcements continuously in every second bed course.

**Step 7.** Mix and pour grout into all block cells, including those with vertical steel bars in them and those without bars as indicated in the plans shown in Figure 5. Grout lifts can be made most conveniently every second block course since it is easier to keep the cells clear of excess mortar when lower lift heights are used. The maximum height of any single grout lift should be limited to 4 ft.

**Step 8.** Provide sleeves or holes in walls for piping or conduit of a size and location as required. In the example facility, these openings have been located so that a minimum amount of cutting of block units is required. Cutting may be done with a masonry saw or with a masonry blade in a power saw (available for use in small hand tools) in order to avoid cracked block that likely would occur if a hammer and brick chisel were used.

**Step 9.** Continue the masonry work for the full heights of all walls. When the walls are complete, alternate vertical bars should extend above the walls from the grouted cells. After the grout has set up for several days, the vertical bars in some perimeter walls should be bent 90 degrees inward, with their horizontal position about 2" above the tops of the walls so that they lie in the place of the reinforcement steel that is to be placed later for the roof slab. Vertical bars in walls around the hatchway are left projecting straight up.

## GROUT

Grout is a term used to describe a "cementous" mix placed in reinforced masonry walls. The grout is poured into the wall cavities (cells of the masonry block in out case) to form a bond between the masonry units and the reinforcement steel. By achieving this bond, a significantly stronger wall is created.

Grout actually is mortar that is thinned by adding more water so that the mix will pour. The grout mix is poured into the block cells at intermediate levels or courses as the masonry units are laid.

Building codes typically place limitations upon grout work, due to its structural purposes. For example the cavities (block cells) must be kept clean and clear of loose mortar as the block work progresses, and the height of any single pour of grout (called a lift) is limited to not more than 4 ft. unless other precautions are taken during the pouring phase.

For the 6' - 8" high walls of the example facility the grout can be poured within the 4 ft. height limit placed upon such work simply by doing the pours in two lifts. However, for anyone inexperienced with grouting operations, more reliable workmanship is likely if the grout lifts are made about every 2 ft. (every third block course) or even every second block course just before each layer of horizontal joint reinforcement is placed.

All vertical reinforcement bars in block cells will need to be in place before the first grout pour is made, including those bars that are not wired to dowels. Careful workmanship is required during the grout pours to keep the bars in vertical alignment and correctly positioned in the cells.

## PIPE AND CONDUIT THROUGH WALLS

Pipe and conduit passing through the shelter walls should be accommodated as the masonry is laid. Waterproofing problems which may be created by the pipe penetrations through the walls are discussed below and in Section 7.

Refer to Figure 5, 6, and 8 for locations of sleeves or pipes required for ventilating the shelter. Placement of sleeves for electrical conduit and water piping (inlet and outlet piping for the swimming pool filtration equipment in the example shelter) are not indicated specifically in the plans shown here and is left to be decided by each builder.

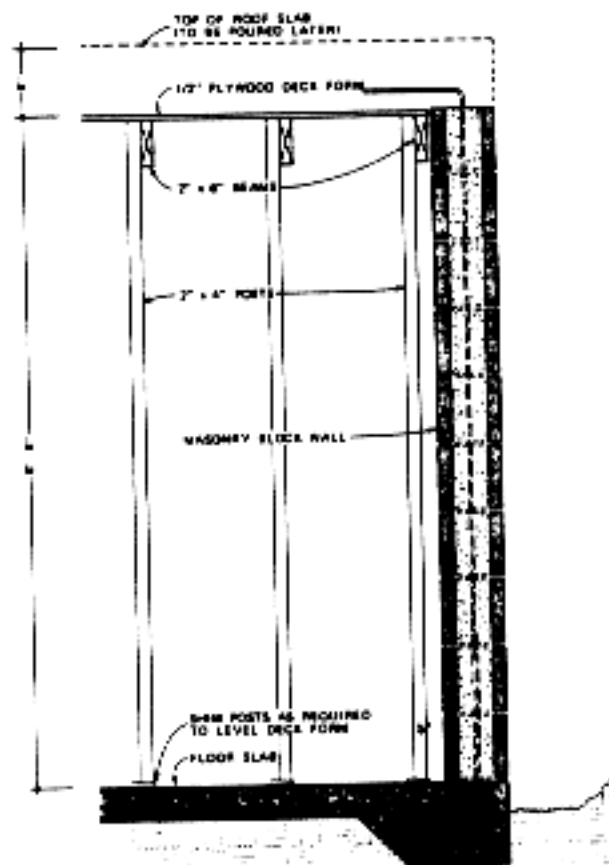

Figure 49. Cross section - placement of shoring framework

If the shelter is placed in soil conditions where there is good drainage, then a watertight seal is not necessary at the point in the walls where pipes penetrate. In such cases, the pipe or conduit can be pushed through the openings cut or left in the masonry work and later sealed around the perimeters of the penetrations with pitch or caulk. Alternatively, sleeves slightly larger than the outside diameters of the pipes can be set and mortared into the walls so that the piping can be pushed through at a later time. Sleeves offer a more tidy construction appearance but require a bit more work to install.

If the shelter is placed in soil conditions where ground water pressure is possible against the walls, then a watertight seal of pipe penetrations must be provided. It is difficult to achieve a permanent watertight seal for pipes passing through a wall. Sleeves in the wall, well sealed after the piping is passed through and tightly sealed where they pass through waterproofing membrane at the outer wall surface, are perhaps the most suitable solution for a facility of the type described in this booklet.



## CONSTRUCTING THE ROOF SLAB

Procedures for forming and pouring the reinforced concrete roof slab of the home shelter are described in this section. This work is possibly the most complicated of all tasks in construction of the facility and requires the greatest overall care. Forms for the slab must be supported solidly (shored) to carry the wet concrete before it sets up, and reinforcement steel must be placed in accordance with engineered drawing so that structural performance of the roof slab is as required. The work includes the following tasks.

Construct a shoring framework inside the space so that the forms for the roof slab may be fully supported.

Place plywood forms for the bottom of the roof slab at the required elevation so that they bear on and are supported by the shoring framework.

Place edge forms for the roof slab, using posts against the outside faces of the masonry block walls for support.

Construct and place edge forms for the hatchway opening in the roof slab.

Cut and place reinforcement steel of the required lengths in the forms, as indicated in engineered drawings.

Pour the concrete roof slab and trowel finish the top surface.

### LAYOUT AND CONSTRUCTION OF SHORING

In order to construct the shoring that supports the forms for the roof slab concrete work, it is necessary first to plan the layout of the forms onto which the slab will be poured so that the shoring is positioned where support is needed for the forms.

Figure 51 indicates the layout of the bottom plywood forms. Standard 4' X 8' plywood sheets can be used for all surfaces except near the hatchway opening. Figure 49 indicates the layout and sizes of the beams and post for the shoring framework. The wood beams are spaced so that there is one at each plywood edge along the 8 ft. length of the panels. The bottom forms for the roof slab, consisting of 1/2" plywood, are to be placed at a height so that the bottom surface of the roof slab is level with the top of the uppermost block course. The plywood is supported by closely spaced wood beams because, the plywood alone is not of sufficient strength to carry the wet concrete. In turn the wood beams are supported by wood posts which bear upon the concrete floor slab. The shoring framework is engineered to insure that it will carry the wet concrete when poured.

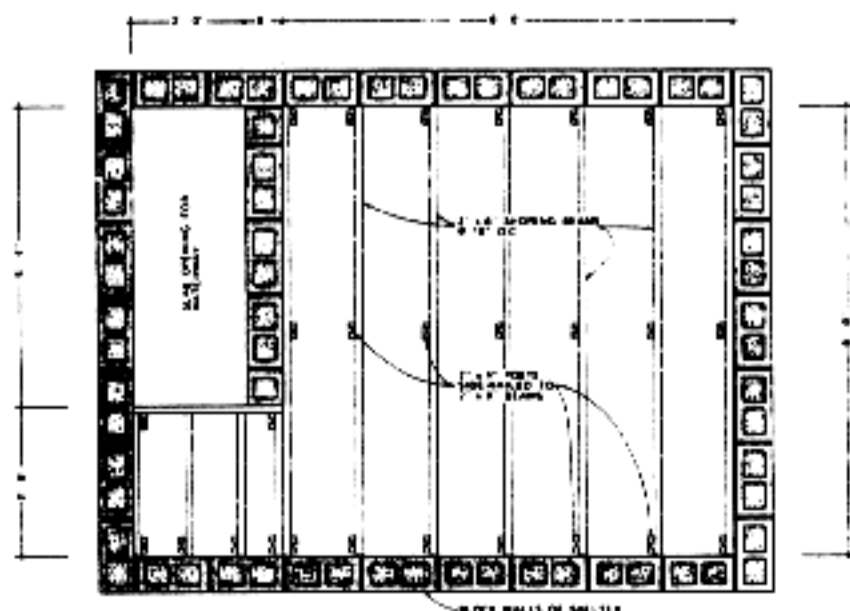

Figure 50. Plan layout of shoring framework for roof deck forms

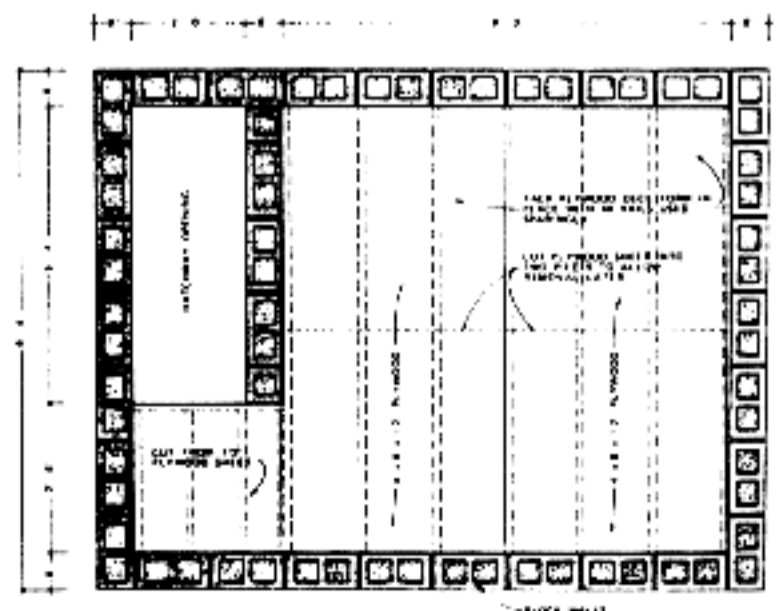

Figure 51. Plan layout of plywood for bottom forms of roof deck

One thing is to be remembered in constructing the shoring and framework. These are to be removed after the concrete has been poured, so they must be of a size and assembled in a manner that they can be removed through the hatchway opening in the roof slab. One way to accomplish this is to cut the plywood into 4 ft. sections (half sheet sections) before it is nailed into place. The smaller sheets will fit through the hatchway opening.

### ***EDGE FORMS FOR THE ROOF SLAB***

Placement of edge forms for the roof slab requires a bit of ingenuity to hold them in place, due to the fact that the outside edges of the finished slab are to be flush with the outside faces of the block walls. For the example facility, the edge forms are held in place against the block walls as is indicated in Figure 52, using 2" X 4" post for support. These post can be nailed temporarily to the block walls they can be extended down to the ground for bearing, or they can be wedged at an angle to the wall, again using the ground for bearing.

Edge form boards are cut from 2" X 10"s. The 9 1/2" net depth of the forms allows the top edges to be set flush with the top surface elevation of the roof slab and still leaves a part of the boards to extend slightly below the top surface of the masonry block. The face lines of the block walls thus establish the edges of the roof slab.

Edge forms at the inside faces of the hatchway opening in the roof slab should be constructed in the same manner as for the outside edges of the slab, as shown in Figure 53.

### ***RETAINING COLLAR FOR EDGE FORMS***

The outward acting pressure that will result from the wet concrete when it is poured will tend to push the edge of the forms outward unless they are retained until the concrete has set up. Displacement of the edge form during the concrete pour would be a major set back, even for an experienced builder. Forms are almost impossible to move back into their correct position once the pressure of the wet and heavy concrete is upon them, and so extra caution is required to insure that the forms are firmly positioned and secured before any concrete work is commenced.

For the edge forms of the roof slab of the example shelter, a retaining collar, consisting of 2" X 4"s positioned as shown in Figure 54, is provided to retain the forms against outward acting pressure. The retaining collar extends completely around the perimeter of the roof slab edge forms to brace the 2" X 10"s.

Edge forms along the inside faces of the hatchway opening also need to be retained. These forms can be held in place against outward acting pressure by means of 2" X 4" blocking between opposite faces of the 2" X 10"s, as is indicated in Figure 53.

### ***REINFORCEMENT STEEL FOR THE ROOF SLAB***

Reinforcement steel and its locations for the roof slab are indicated in Figure 55. The reinforcement consists of No. 4 bars placed in both directions of the slab. Bars are spaced at 8" intervals (8" o.c.) running in the narrower direction of the slab. These bars provide structural support for the slab. Bars are spaced at 16" o.c. running in the longer direction of the slab and are for temperature reinforcement of the concrete.

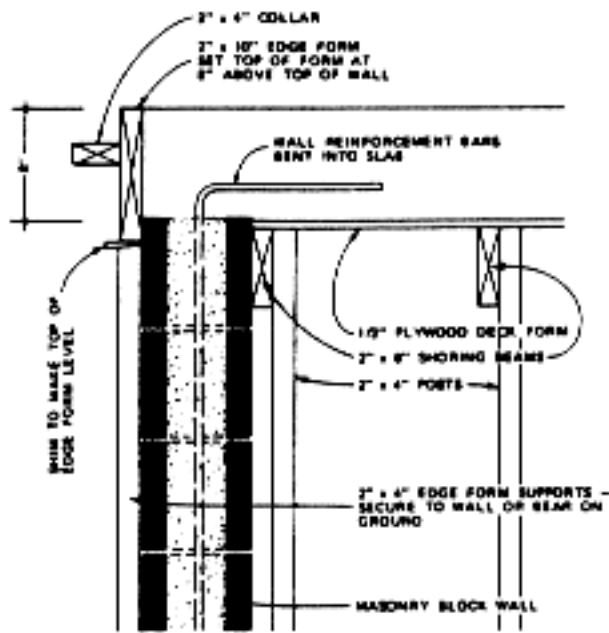

Figure 52. Cross section showing placement of edge forms for roof slab

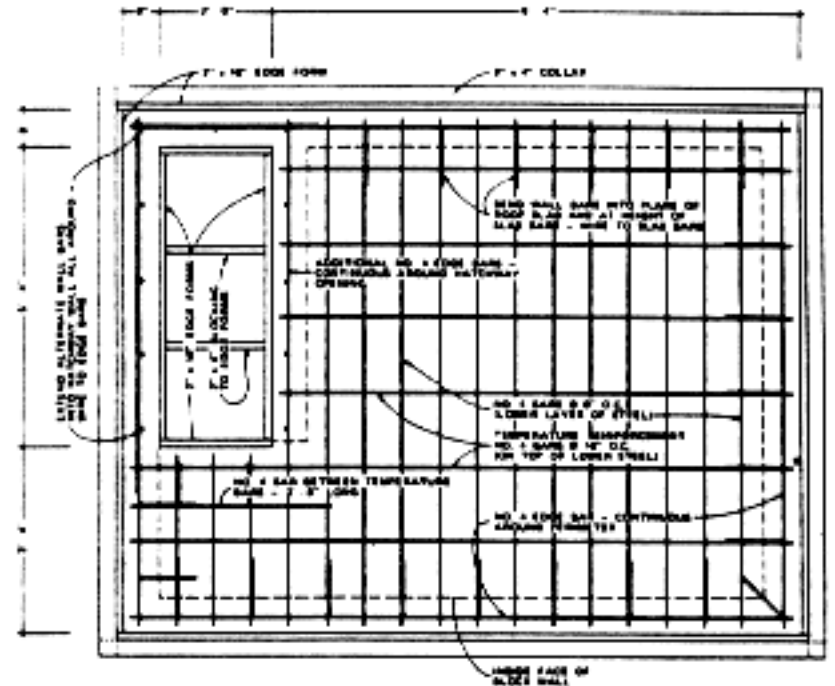

Figure 55. Plan view of roof slab reinforcement steel

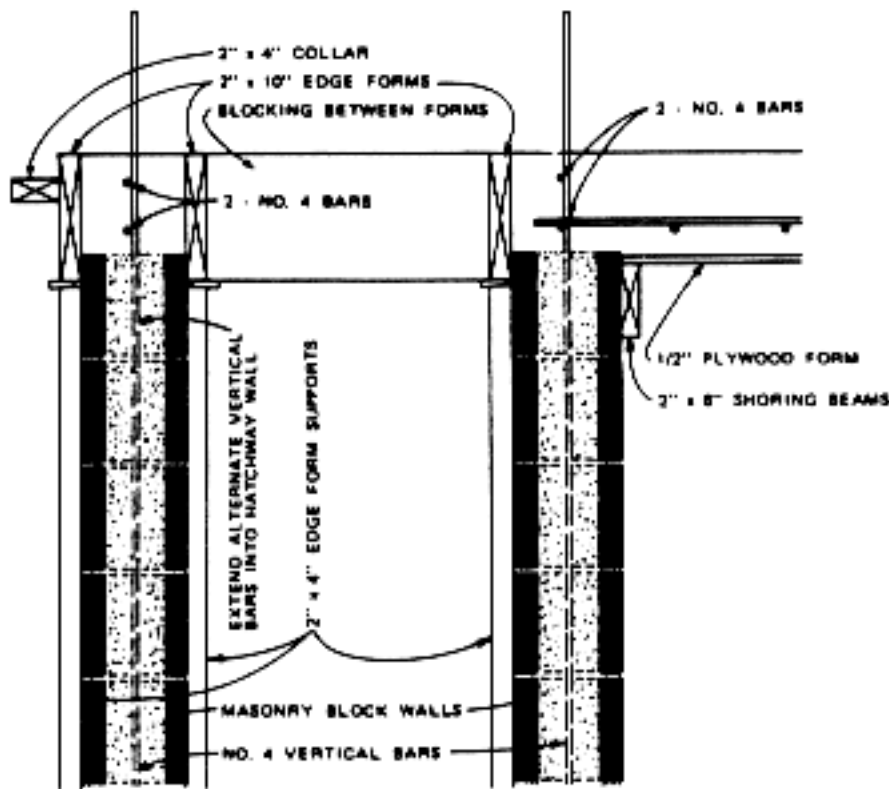

Figure 53. Placement of edge forms for roof slab at hatchway

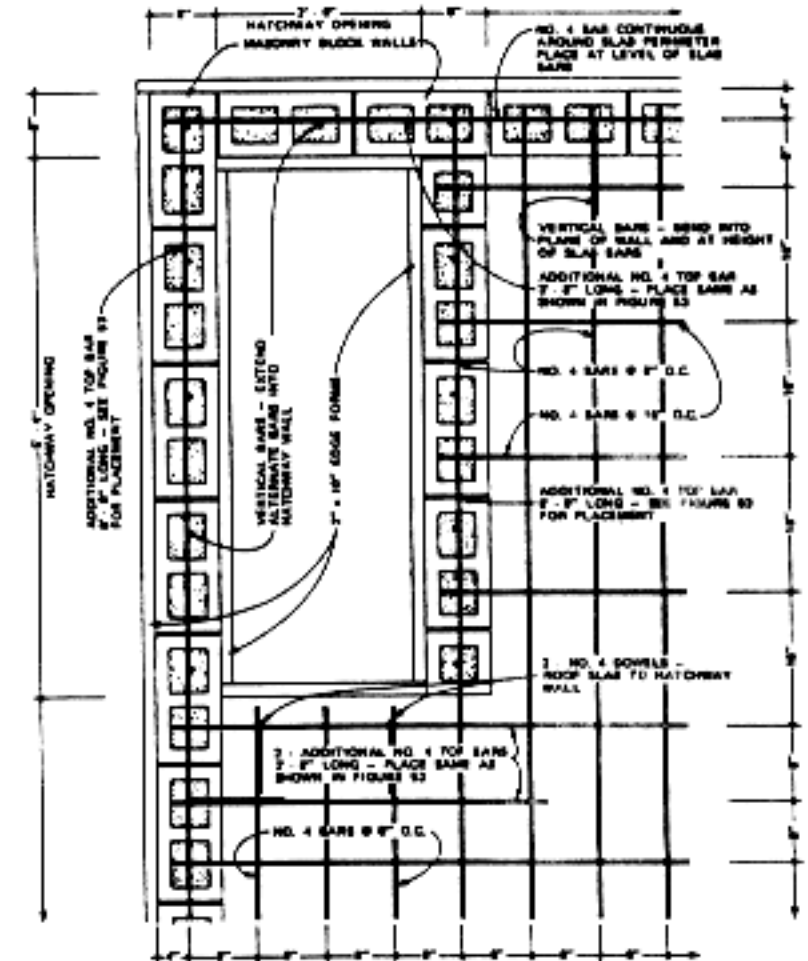

Figure 56. Roof slab edge reinforcement around hatchway

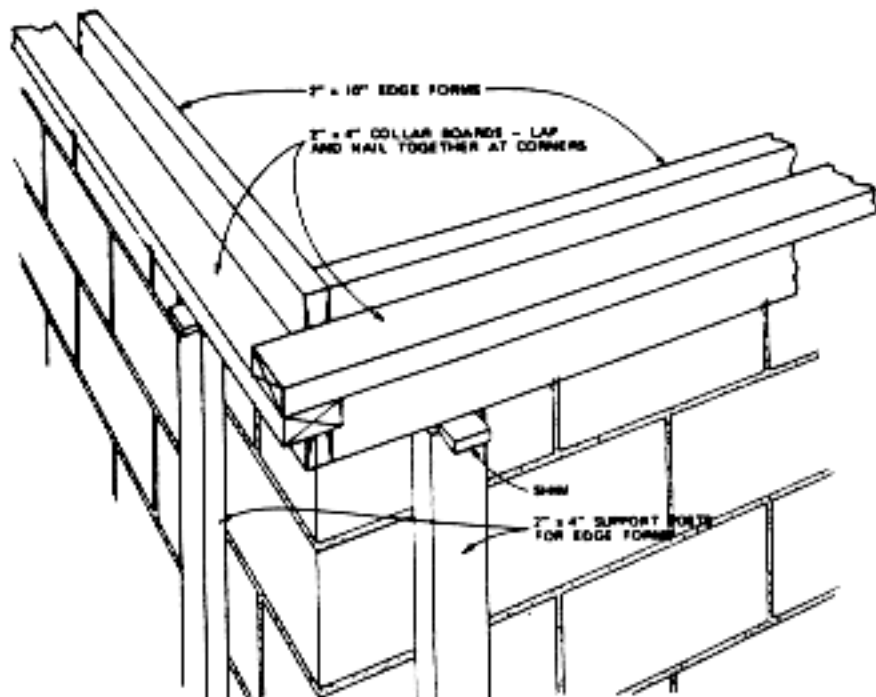

Figure 54. Retaining collar to hold forms of roof slab in place

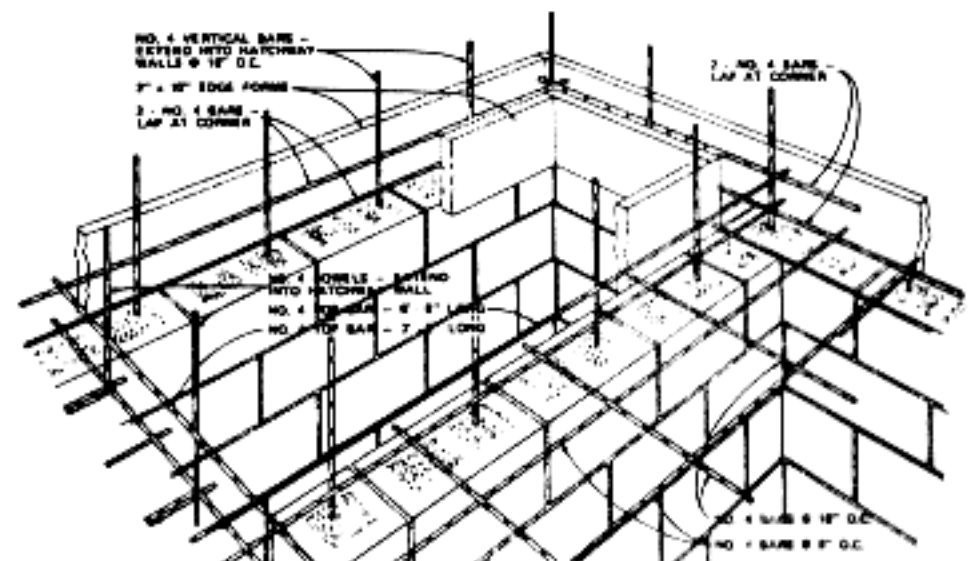

Figure 57. Placement of roof slab reinforcement steel at hatchway



Except around the hatchway walls reinforcement bars extending out of the block walls are bent 90 degrees into the plane of the horizontal bars of the roof slab and are securely wired to intersecting slab bars (the projecting wall bars are on 16" centers). Bars that extend above the hatchway walls are not bent over but are left straight upright to reinforce the block of the upper hatchway walls that will be laid later.

Slab reinforcement is positioned so that the undersides of the lower bars (the lower bars are the ones spaced 8" o.c.) are 2" above the plywood forms. These bars should rest on wire seats that are made especially for this purpose, called chairs. Chair spacing should be about 40" o.c. or as required so that all bars are held in the correct position and elevation within the slab. Reinforcement steel in the other direction (the bars spaced at 16" o.c. and crossing the structural reinforcement at right angles) is placed immediately on top of the structural reinforcement and is wired to the lower bars at each intersection. Provide seats as required so that the bars are level in the plywood forms.

Additional reinforcement is provided around the perimeter of the slab opening for the hatchway to resist the increased stresses expected at these edges. At the perimeter, two No. 4 bars are placed, as indicated in Figures 56 and 57. One bar is placed at the elevation of the slab reinforcement steel; the other bar is placed directly above the lower bar and about 2" below the top surface of the slab. The top bars are supported by and wired to the vertical bars projecting upward from the block walls. These vertical bars are left projecting upward to reinforce the upper block walls of the hatchway.

At one end of the hatchway opening (the lower end in Figure 55) where there is no wall below the slab, two No. 4 dowels are wired to the reinforcement steel so that their vertical legs project above the slab and provide support for that segment of the upper hatchway wall (see figure 57)

### **ROOF SLAB CONCRETE**

Concrete for the roof slab should be of 2,500 psi compressive strength (the same mix as used for the floor slab). Proceed to pour the concrete, using ready mix or site mix, in the same manner as described for placing the floor slab. Screeding of the surface can be accomplished using the tops of the edge forms for a guide.

Special care should be given to thoroughly tamping the wet concrete so that all air pockets are filled on the flat surfaces of the plywood forms. These air pockets will not be visible until the forms are removed but will create a honeycombed finish on the underside of the slab if the concrete is not thoroughly tamped.

Curing time for the roof slab concrete must be allowed before the supporting form work is removed. The shored forms should be left in place a minimum of 14 days to allow the concrete to develop its strength. Edge forms, however may be removed after about 24 hours. Greater concrete strength will result if the concrete slab is covered with a polyethylene film and kept moist during the curing period.

### **PROTECTION AGAINST WATER SEEPAGE**

Any structure built below ground risks the chance that water will seep into the space. The risk of water entry is dependent upon the presence of ground water in the excavation and also upon the extent to which the construction resists the seepage.

The accumulation of ground water around a structure is affected by the height of the surrounding water table and by the porosity of the soil (its ability to drain the water). If the level of the surrounding water table is higher than the bottom elevation of the excavation, then waterproofing of the construction surfaces is needed, or the level of the floor slab should be raised above the water level. Waterproofing can be costly and also requires great care in installation. For a home shelter, it probably would be wiser to rise the level of the floor slab so that it sits above the water level rather than attempt to create a waterproof facility.

For facilities built above the water table level, there are still other problems that may result in the entry of water into the space or may result in dampness of the walls and slabs against the soil. For example, soils of mostly clay do not drain readily, and there is a possibility that water will accumulate in the excavation simply from surface run off. If this occurs the accumulated water likely will find its way into the shelter, with a resulting dampness of the inside surface that is not attractive for habitable use of the space. In such cases, waterproofing still may be necessary.

Even when the soil is of a type that drains well, such as sand and gravel mixed with a little clay binder, there remains a moisture problem that should be dealt with in the construction of any underground facility. The problem arises because nearly all soils hold moisture (they remain damp when not exposed to the air), and because concrete and masonry materials tend to absorb moisture. This problem is met by installing dampproofing. The dampproofing is a moisture barrier, such as polyethylene film or asphalt saturated felt, that is placed on the outside surface of the concrete or masonry material to keep the moisture away from the material.

Dampproofing is not the same as waterproofing in the sense that a complete water barrier is not the purpose of dampproofing. Dampproofing affords a suitable solution to moisture problems only when water is not accumulated in the excavation area around a structure. Otherwise, waterproofing is needed.

Considerations for dampproofing and waterproofing are described separately on the next page. Each owner / builder will need to evaluate his own soil and water conditions and then decide upon the degree of protecting to provide against water seepage.

### ***MOISTURE PROTECTION FOR WALLS AND ROOF SLAB***

Moisture protection for walls and roof of a belowground facility is needed because these surfaces also are against wet or damp soil. The type of protection for walls and roof to guard against the entry of water should be selected to meet the particular conditions of the site and the facility.

If only dampproofing is needed, this can be achieved by coating the outer wall surface (the surface against the soil) with an asphalt emulsion (a liquid asphalt that is painted onto the surface and dries to form a water resistant coating) or by a sheet type membrane that is impervious to water such as polyethylene film or hot mopped felt (asphalt saturated paper that is applied and sealed with hot asphalt). Application of the dampproofing should occur after the roof slab is placed but before backfilling is done.

If a watertight seal is required, then a more reliable membrane should be installed, and especially, greater care should be given to sealing all joints and avoiding puncturing the membrane. Whatever type of membrane material is selected, it will require that a protective board be placed between the membrane and the backfill soil to safeguard the material against punctures (protection boards are described in Section 8). Lapped and sealed joints at edges of the membrane at intersections with membranes of other surfaces (floor slab, walls, and roof slab), and at holes for pipe penetrations will be necessary to provide a complete watertight installation.

### ***MOISTURE PROTECTION FOR FLOOR SLAB***

Any concrete floor slab that bears on damp or moist soil will absorb water to some extent. For the floor slab of the example underground shelter, moisture absorption and a consequent damp floor almost certainly will occur unless a moisture barrier is placed between the slab and the soil. Whether or not dampproofing is adequate if a waterproofing membrane is needed will depend upon the presence of water pressure (accumulated water) at the slab level.

The dampproofing membrane is a material impervious to moisture penetration which is laid over the entire area of the floor slab before the concrete is poured. The principal distinctions between dampproofing and waterproofing membranes (a moisture barrier versus a complete waterproof seal) are in the material selected for the membrane and in the installation work. For dampproofing membranes, edges are simply overlapped; whereas for waterproof membranes, the edges and all penetrations are sealed water tight. For waterproofing, a more reliable and sturdier material usually is chosen for the membrane.

Dampproofing is most easily provided for the floor slab as an example shelter using a single sheet of polyethylene (plastic) film of 6 mil thickness. The plastic film placed between the ground surface and the concrete slab that is to be poured. The film should be cut to a size so the that it extends approximately 16" beyond each side of the slab. The excess will be turned up onto the masonry walls late and overlapped with other dampproofing material placed against the block walls after they are constructed. The placement of a dampproofing membrane for the home shelter is indicated in Figure 58.

### STEP ● BY ● STEP ● PROCEDURE

**DAMPPROOFING** The purpose of dampproofing is to prevent absorption of moisture by construction materials that may be placed against damp soils. The dampproofing material is placed between the construction material and the soil. It consists of a membrane made up of sheet material (such as plastic film, or asphalt saturated felt) or of a painted on material (such as asphalt or tar) that prevents passage of moisture.

The membrane should cover all surfaces where moisture may be present but the purpose of membrane is not to provide a watertight seal. Figure 59 indicates the basic installation of dampproofing for the example shelter.

Great care should be exercised in placing the membrane so that it is not punctured or scraped either during its placement or later by working on top of it. Although punctures will not pose critical future problems (remember, we are dealing with moisture barrier rather than a watertight seal), neither will holes in the membrane be beneficial to the purpose if its installation. Puncturing and tearing of film membranes placed under the floor slab are especially possible when steel reinforcement is placed and the concrete is poured. In general, one should avoid walking or working upon the moisture barrier once it is in place.

### STEP ● BY ● STEP ● PROCEDURE

**WATERPROOFING** Waterproofing, as the term implies, aims at providing a watertight separation between the structure and the surrounding soil. Since water will flow through even tiny openings, it is essential that a watertight seal be constructed when waterproofing is the goal. Proper installation of waterproofing membranes is a challenge even for the best contractors, and great care is required in the installation work. Membrane waterproofing relies upon use of a membrane material that is impervious to passage of water. The membrane is wrapped around the entire outer surface of a buried structure and edges and overlaps of the membrane are sealed to provide watertight joints. Care must be exercised in placing and working around the membrane to avoid puncturing it (any puncture at all will cause the loss of the watertight seal), and all edges must be fully and continuously sealed. Also the edges at any penetration of the membrane such as pipes passing through must be completely sealed. Several types of membranes are used for waterproofing plastic, rubber, or asphalt saturated fabric. Some membranes may be purchased as sheet material; others are available in semi-liquid form which are painted or sprayed onto the wall or roof surface. The compound to be used for sealing edges is selected which will bond to the particular type of membrane material used.

In general, the waterproofing membrane is installed on the outer surface of the structure between the floor, walls, and roof and the surrounding soil. It is good practice to cover the membrane on the walls and roof with protection board to avoid the possibility of punctures from sharp stones in the soil or from later construction work. Figure 60 indicates the basic waterproofing installation for the example home shelter.

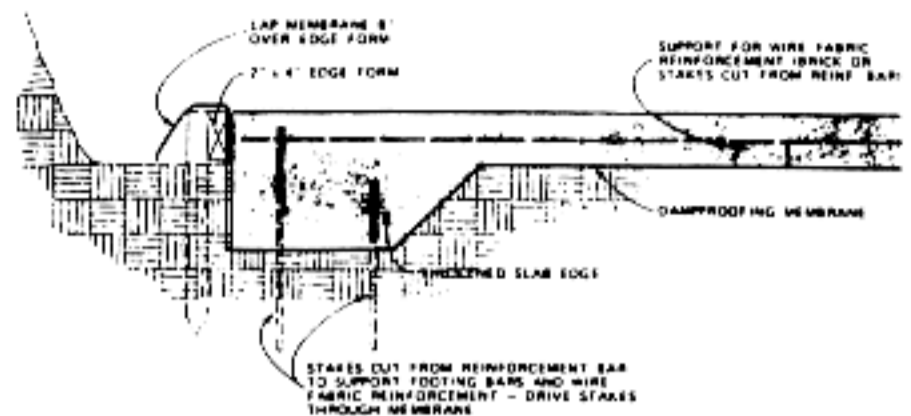

Figure 58. Placement of dampproofing membrane under floor slab

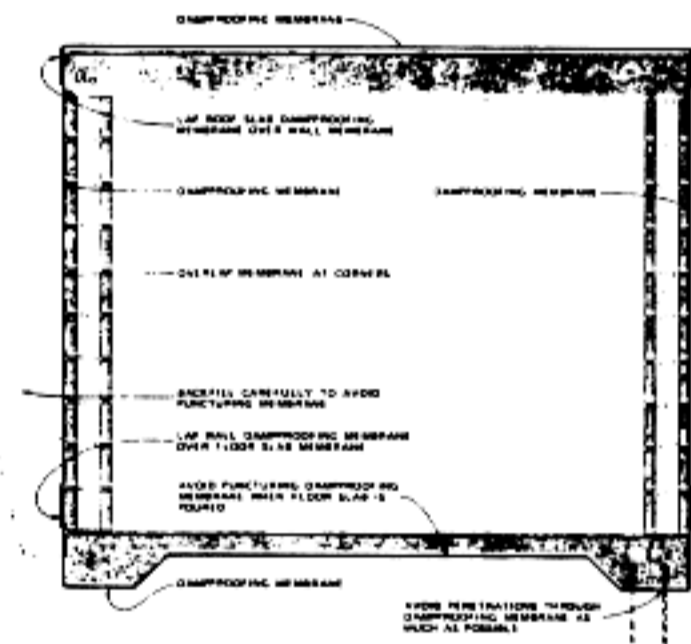

Figure 59. Schematic concept of dampproofing for the structure

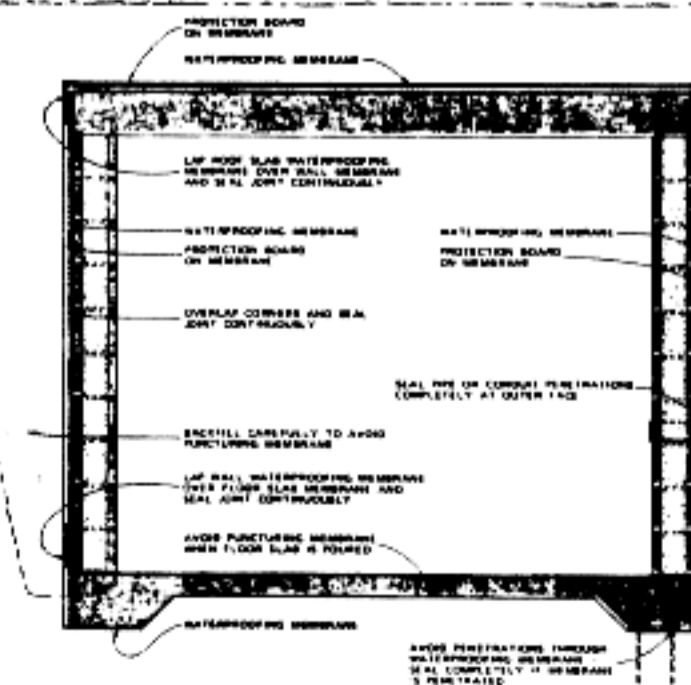

Figure 60. Schematic concept of waterproofing for the structure



---

## **WORK TO COMPLETE BEFORE BACKFILLING**

Backfilling operations should not be commenced until all dampproofing or waterproofing work is completed and all piping and conduit in to the facility are placed. Any other construction work that intersects the excavation area also should be complete so that soil is not unnecessarily moved twice.

Less soil will need to be moved if any remaining excavation work is completed before backfilling. The additional excavating work for the example facility consists of preparation for placement of footings for the brick planter walls and completion of the work. Any additional soil that must be excavated in order to place the planter wall footings can be shoveled into the backfill space around the shelter walls.

The amount of soil, if any, to be excavated for the planter wall footings will depend upon the slopes of the side walls of the original excavation is indicated in Figure 62, it is possible that the footings will need to be placed upon fill soil. In such a case, backfill soil can be placed up to the level of the bottoms of the planter wall footings.

If further excavation is necessary to place the footings, cut to the bottom elevation of the footing, measured relative to the vertical reference point used for prior measurements. Allow ample room on both sides of the footing so that footing forms can be placed and brick masonry can be laid. Excess soil from an excavation can be used as backfill material around the shelter.

In the event that part or all of the planter wall footing bearing lies inside the slope of the original excavation, then fill soil must be placed up to the bottom of the footing. Any such fill soil must be moistened and thoroughly compacted to provide firm bearing of the footing.

The remaining backfill work should be completed after the planter walls are constructed. The soil cover over the roof should be placed after the hatchway walls have been completed.

## **PROTECTION BOARD**

Protection of dampproofing or waterproofing membranes during backfilling operations is essential in order to preserve the water barrier. Rocks or other debris that may rest against the membranes are likely to tear or scar them a critical concern especially for waterproofing membranes. Due to the fact that most backfilling is done by power machinery, it is best to provide a positive protection for the membrane rather than rely upon careful work by the machine operator.

Backfill protection typically is provided by means of inexpensive sheets of fiberboard, used plywood from forms or other such material that is placed against the membrane before the soil is placed. Any material of the type indicated will do because the need for protection is temporary during the time of the backfilling operation.

Protection boards should be placed on all surfaces where soil is to be placed, including vertically at the walls and horizontally on the roof slab of the example facility.

The protection board remains in place after the backfilling operations completed. It is of no concern that the material eventually may deteriorate in the damp soil.

## **THE BACKFILL OPERATION**

The backfill operation refers to replacement of excavated soil around the completed shell of the shelter. For the example facility, backfilling is required around the walls of the shelter, around the planter walls, and on top of the roof slab. To achieve well compacted backfill, soil should be placed in lifts of 6" maximum, with each layer moistened, not saturated and then compacted. Care should be exercised during backfill operations so that the dampproofing or waterproofing membrane is not damaged.

Avoid placing any rocks larger than about 1" in diameter in the backfill material that rest against the dampproofing membrane, the waterproofing membrane or the protection board that may be used to cover either. If protection board is not used, a layer of sand against the wall membranes will provide the next best safeguard against damage by rocks. To protect the dampproofing or waterproofing membrane of the roof slab, in addition to any protection board that may be used and to provide good drainage through the soil atop the roof, place a 6" layer of sand as the first backfill material on the surface. Any other backfill material and top soil then should be placed in 6" lifts and compacted.

# FOOTINGS

Footings for the planter walls should be placed upon firm soil either undisturbed soil at the bottom of the excavation or thoroughly compacted fill material. Figure 62 indicates one type of condition for which compacted fill may be necessary. Corners for the planter wall footings may be located in the same manner as described in Section 3 for the floor slab of the shelter. Elevations of the tops of the footings should be established using a transit level or water filled hose as is described on pages 15 and 16. Footings for the planter walls should be side formed (both sides) using 2" X 10"s held in place by stakes nailed to the sides, as shown in Figure 61. Corners should be set with identical elevations to the tops of the footings and verified for accuracy relative to the original point of vertical reference. Batter boards may be the most convenient way to accurately set the corners of the footing forms. Note for the example shelter that the elevation of the tops of the planter wall footings has been established after first establishing the elevation of the tops of the planter walls relative to the surrounding yard and working backward to the top of the footings, using the coursing height of the brick and block to set the elevation belowground. Use has been made of the fact that in general one block course equals three bricks course. Keeping with this relationship, the heights of the planter walls has been coordinate with the elevations of the block walls of the main structure and the raised hatchway. The depth of the planter wall footing below the surface of the ground should be based upon the maximum expected depth of the frost level in the region in which the facility is constructed. The bottoms of the footings should be set at or below the maximum frost level. This is because freezing action of moisture in the soil possibly could heave the planter wall upward if this precaution is not taken. Each owner / builder will need to determine the depth of the footings for his shelter location by consulting with local builders or the local building department.

## BRICK MASONRY FOR PLANTER WALLS

Brick is selected for the exposed faces of the planter walls in the example facility to match the appearance of the existing residence and yard. Combined brick and block walls are illustrated.

An alternative would be to construct solid brick walls which could be done without altering any dimensions in the example illustrations. Although brick could be substituted for brick and block in combination, solid brick walls would be more costly for materials and also would increase the labor time for laying the masonry.

Another alternative would be to construct all masonry walls below ground (those not visible to people in the yard) of block, using 12" wide units or two widths comprised of one 8" block unit and one 4" block unit. This alternative also requires no adjustment of dimensions in the example illustrations, and it would be the least costly and most quickly erected wall among the alternatives.

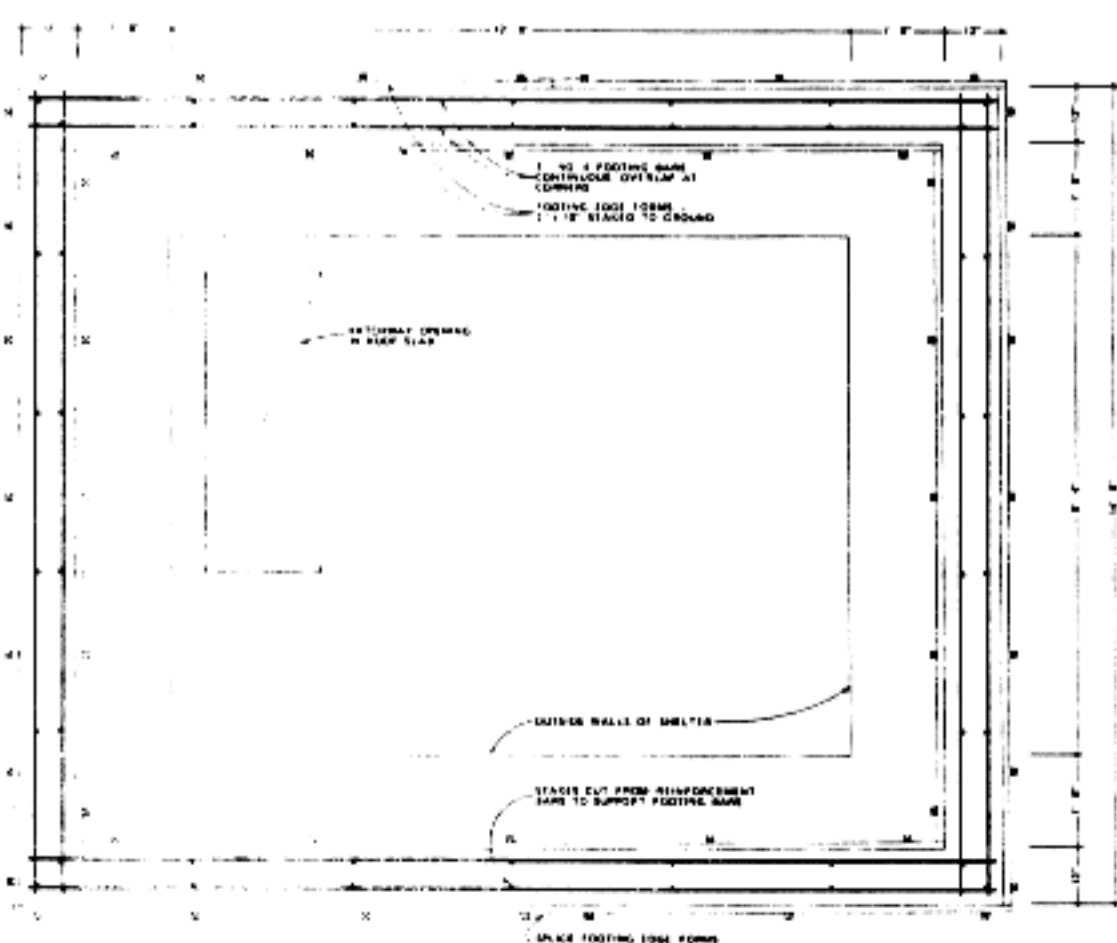

Figure 61. Plan of footing reinforcement steel for planter walls

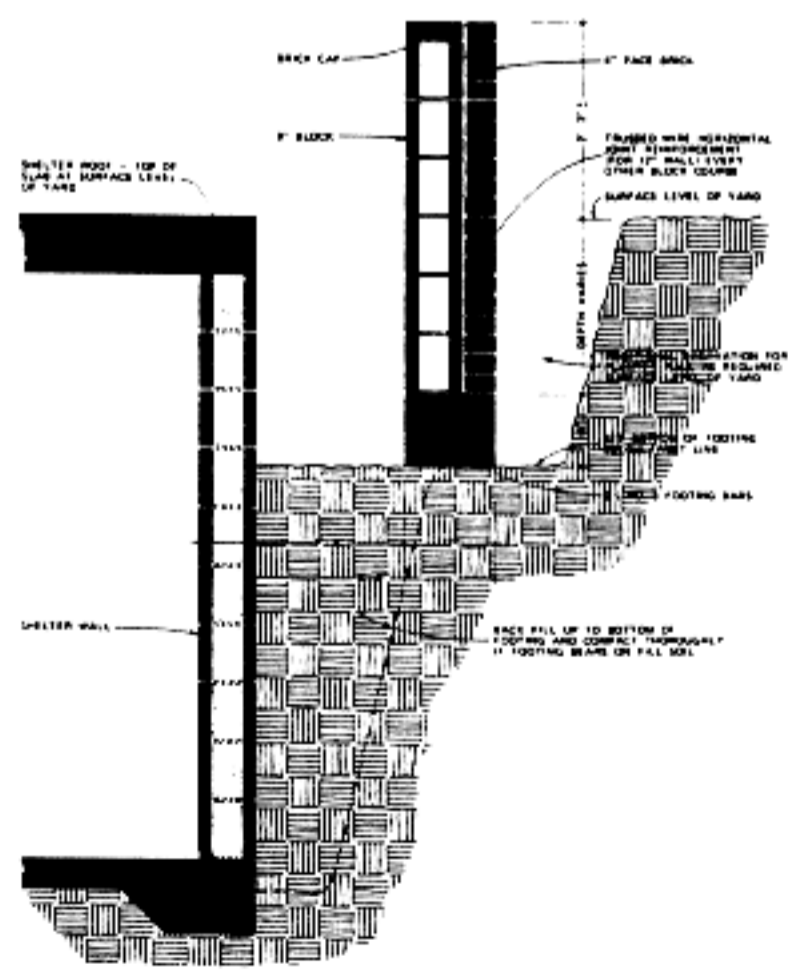

Figure 62. Planter walls location relative to the shelter wall

The bricks selected for the example facility are modular with the masonry block units used for the shelter walls. Since bricks are available in slightly different sizes and also in oversized units, selection should be made carefully so that overall dimensions of the planter walls do not vary from those planned when the bricks are laid. Otherwise some plan dimensions may need to be changed from those used in the example illustrated here. Select bricks of a length that is modular with back-up masonry block units to be laid in the planter walls.

Because the height of the brick planter walls relative to finish grade of the yard is relatively low, overturning of the walls due to soil pressure from the fill behind them is not a problem for the example facility. So, vertical reinforcements of the planter walls is not provided in the example. Vertical reinforcement, tied to dowels placed in the footings, should be used for planter walls higher than 3 ft. above the ground surface of the yard to prevent overturning. Consult with an architect or engineer if vertical reinforcement of the wall appear to be needed.

Horizontal reinforcement is used in the brick and block wall to hold the masonry wythes (the separate planes of masonry that make up the entire wall thickness) together. Trussed joint reinforcement for a 12" wall of two wythes (three wires running horizontally in the reinforcement) is used in the example. The joint reinforcement is placed in every second block bed course as is indicated in Figure 62.

The masonry planter walls should be laid in much the same manner as was described for the shelter walls. The main difference for the planter walls is that two wythes of masonry are to be laid up more or less together a brick wythe on the exposed face and a back up block wythe.

Before laying the masonry, place brick and block units into position dry on the footing to verify locations of the mortar joints in plan. If modular brick and block units are used, as illustrated then the joints of the brick and block will align with two brick length equal to one block length and three brick heights equal to one block height. Mark the joint locations on the footing for use later as a guide when the mortar work proceeds.

#### STEP 1 BY STEP PROCEDURES

##### PLACING THE PLANTER WALL FOOTING

**Step 1.** Locate the outside corners of the planter walls relative to the shelter and also relative to the point of horizontal reference. Set corner stakes and string lines to guide the excavation work, following procedures similar to those described for previous layout work.

**Step 2.** Excavate soil, as required, to the depth of the bottoms of the planter wall footings, or place and compact fill soil if the footing bases lie inside the excavation done earlier for the shelter. Verify the correct depth of the footings using a transit level or water filled hose. Smoothen and level the surface of the soil in the footing trench.

**Step 3.** Place batter boards just outside each corner of the planter walls and adjust them vertically to the correct height of the top of the planter wall footings. Extend string lines across the batter boards to establish the lines and height for the footing side forms. Place another set of string lines across the batter board 12" inside the outer string lines to established locations of the inside faces of the planter wall footings.

**Step 4.** To set side forms for footings, nail stakes on about 4 ft. centers on length of 2" X 10" lumber which will be used for the forms. Abutting ends of lumber should be spliced as indicated in Figure 61 when available lumber length are shorter than the side walls to be formed. Footings for the return walls at the steps will be located and formed later in the construction work.

**Step 5.** Before proceeding, verify that all corners of the footing side forms are at the same elevation. Adjust any forms as may be necessary.

**Step 6.** Brace the footing side forms at about 4 ft. centers along their full lengths on both sides to insure that the wet concrete will not force them outward. Braces can be short lengths of 1" X 4" boards nailed to the tops of the forms at one end and to stakes driven at an angle into the ground at the other end.

**Step 7.** Cut lengths of No. 4 reinforcement bars and place two bars in each footing, as indicated in Figures 61 and 62. Overlap bars at corners. If more than one bar is used for any single length of reinforcement, overlap the bars 24" and wire them together. Bars should be supported along their lengths about 3" above the surface of the soil using short lengths of bars driven into the soil. Dowels in the planter wall footings are not needed for the design shown which does not require vertical reinforcement, but dowels and vertical reinforcement may be necessary if the planter walls project higher above the level of the yard than is indicated in the design that is illustrated.

**Step 8.** Place concrete into the footings forms. Use 2,500 psi concrete. Screed the wet concrete flush with the top edges of the forms. Footing side forms may be removed after the concrete has set up.



The same control rod for vertical coursing that was prepared for the shelter walls may be used for the planter walls, since the vertical coursing height for both walls should be the same. Note that this may not be the case if joint thickness of bottom courses have been adjusted due to unevenness in the elevations at corners. It may be helpful to add marks on the control rod to locate the brick bed courses and joint thickness for each segment of block height.

Begin the masonry work for the planter walls by setting the corners. Block corners should be placed first followed by setting the infill block along the length of the wall segment and using a mason's string for accurate alignment. The block should be laid up two or three courses. Then, brick corners should be set to the same height as the block, followed by laying in fill brick in the wall segment. At the top of the second block course (third bed joint), horizontal joint reinforcement should be placed, and then the next two brick courses laid starting again at the corners.

A brick cap is provided for the planter walls in the example. The bricks are placed flat, as indicated in Figure 62. Note: Some bricks are manufactured with holes throughout the least thickness. When these bricks are laid flat, the exposed holes are aesthetically unsightly. Therefore, it is desirable to select bricks of the cap that do not have holes.

An alternative to the cap of brick laid flat is to lay the cap with the bricks of edge, as is indicated in Figure 64. However, this requires dimensional changes in the height of the top of the planter wall for the example and consequent need to change details of the brick steps and access stair into the shelter.

### **RETURN WALLS**

Construction of return walls at the sides of the brick steps requires careful planning as the planter walls are erected so that the brick and block masonry work ends with the desired visual appearance.

The return walls are placed upon footings that are at a higher elevation than the planter wall footings in the example (see Figure 65 and 66). The footings for the return walls must be poured on compacted soil fill that is placed after the lowermost three courses of block are constructed on the planter wall (Figure 66).

Return walls are 8" thick and consist of 4" face brick and 4" back up blocks wythes, as indicated in Figures 66 and 67. Dimensional information for constructing the return walls is provided in the figures.

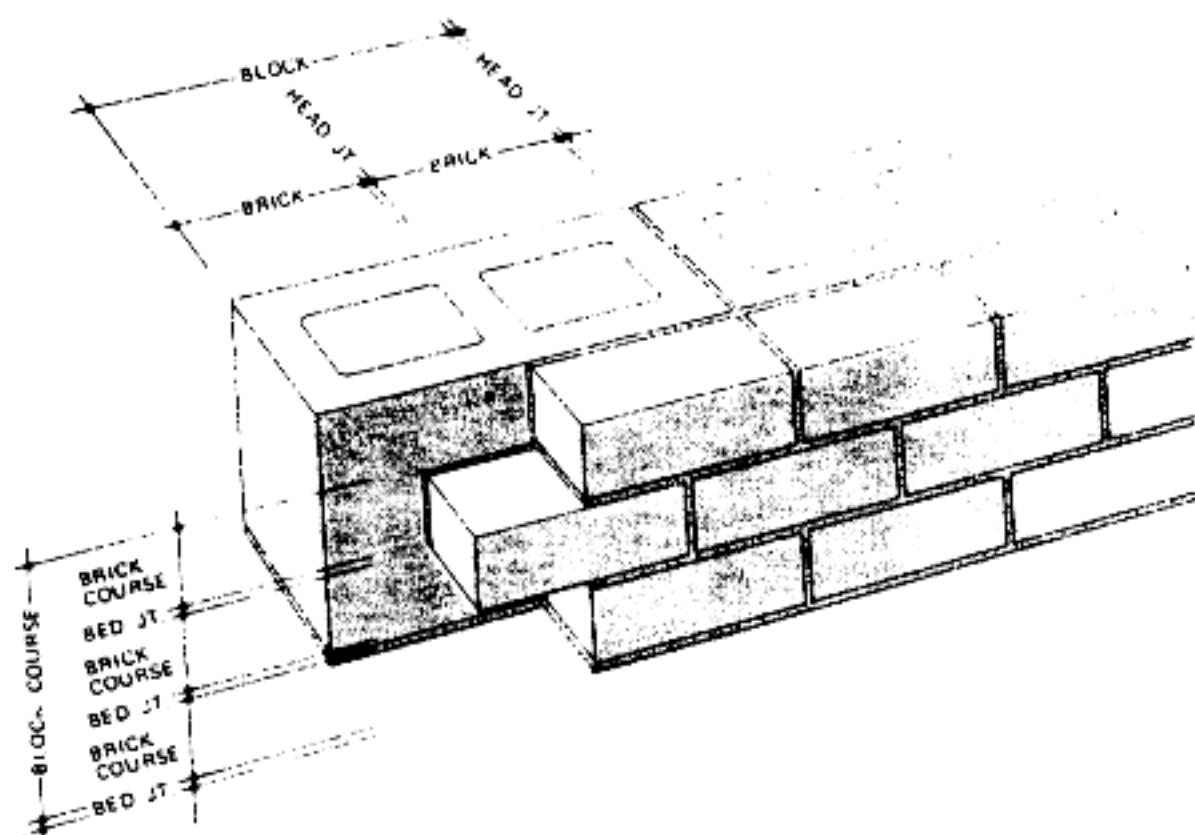

Figure 63. Illustration of modular coursing for brick and block

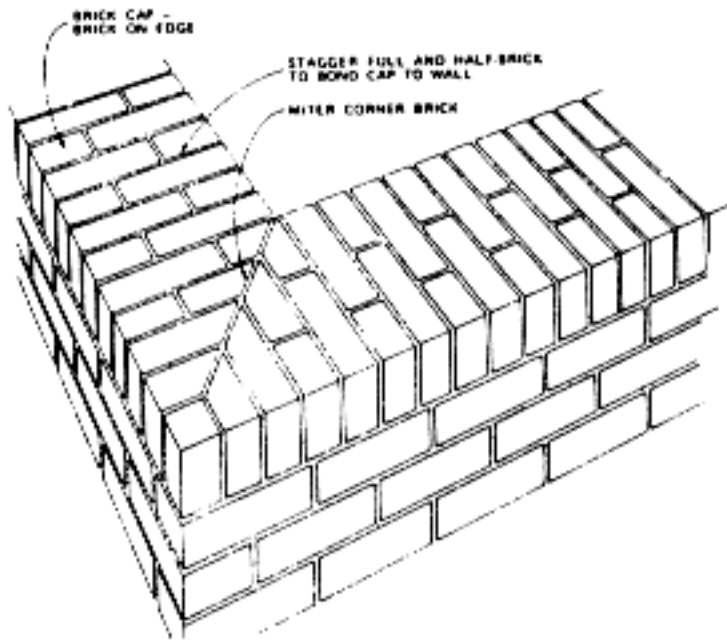

Figure 64. Alternative for brick cap of planter wall

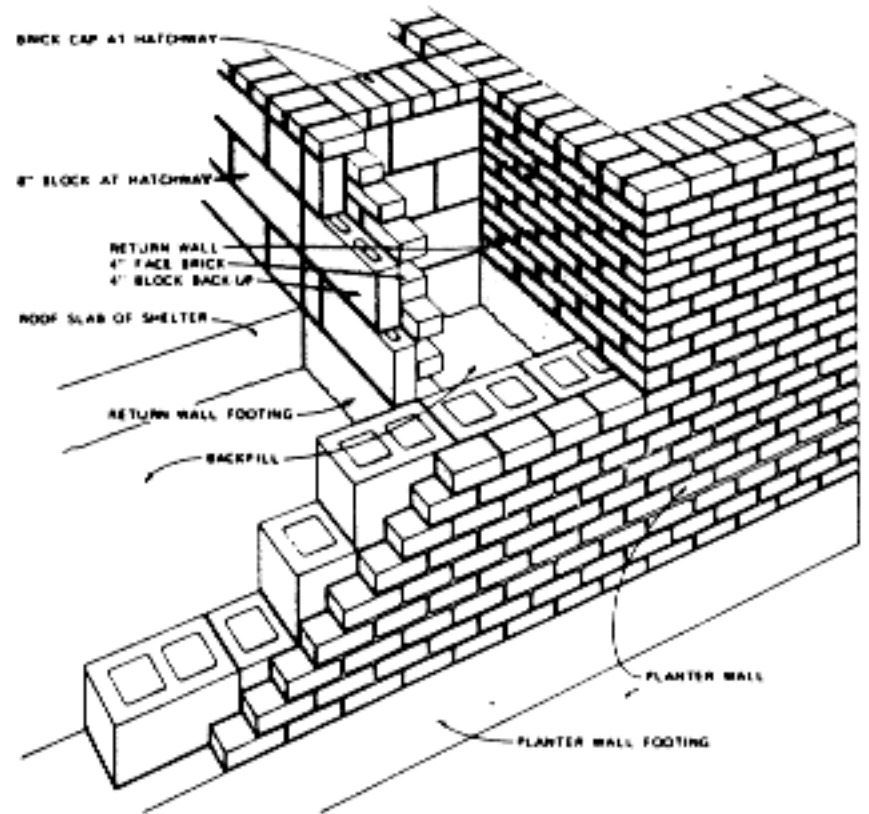

Figure 66. Diagram showing masonry work at return walls

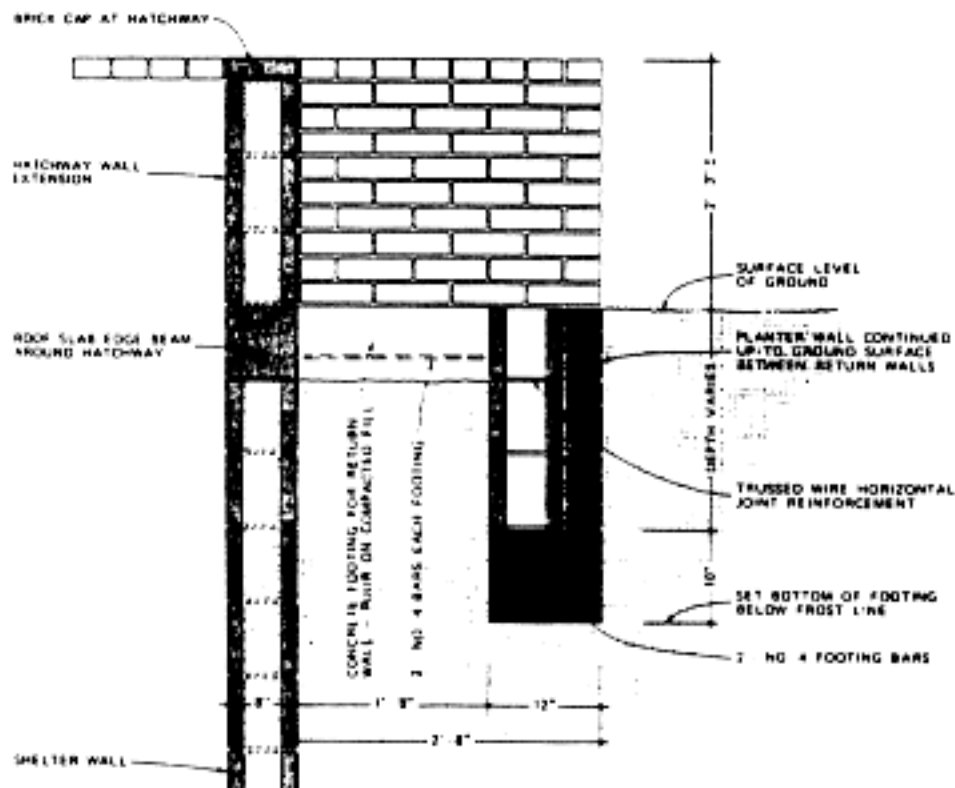

Figure 65. Showing elevation of brick coursing for return wall

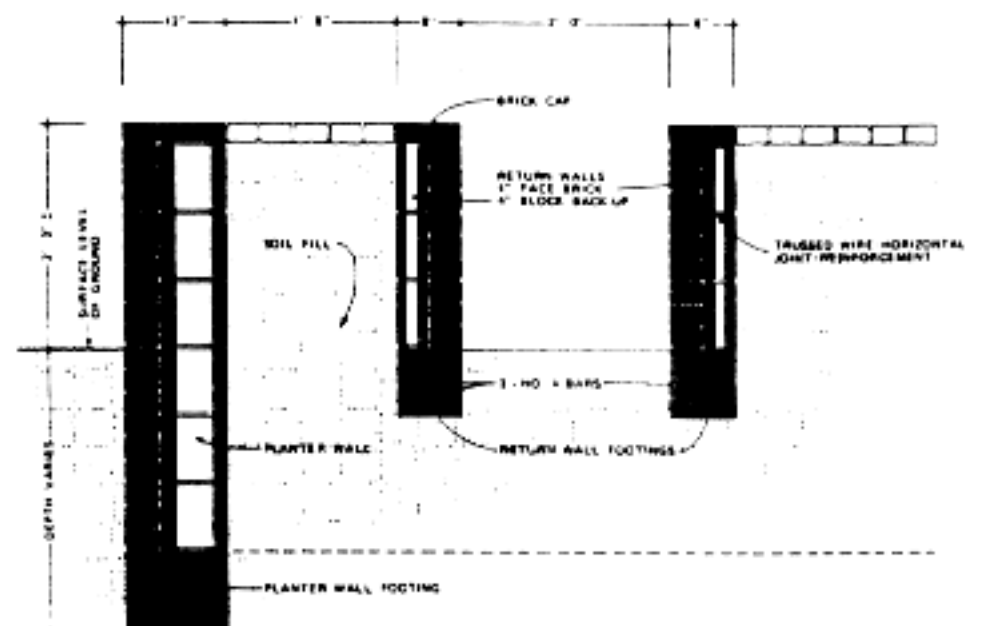

Figure 67. Cross section through return walls at brick steps

## BRICK STEPS

Brick steps leading to the hatchway entry into the shelter should be constructed after the planter walls and return walls are constructed. The dimensions for the steps are coordinated with the modules of the brick and block units of the cutting of masonry units is kept to a minimum.

In the example facility, a little extra consideration has been given to the design of the steps to insure that they will not settle or displace during future use. In particular, the brick pavers are placed upon a concrete base. Although it is possible to construct a masonry base (of brick or block) for the steps, a concrete base is more substantial and actually may be easier in the long run to construct. The concrete base should be placed after the return walls are placed. The concrete base is placed upon a compacted soil fill that is sloped approximately to the angle of the steps (see Figure 68).

As most builders discover when doing nearly all finish work, actual dimensions of the working space need to be taken from field measurements of the surrounding construction.

Adjustments then are made in dimensions of the finish work to fit the field conditions. The reason for using field measurements is that minor dimensional variations almost always occur in construction work—due either to variations in dimensions of materials or to errors by the workmen who completed the adjacent construction.

For the case at hand, riser heights of steps may require adjustments so that steps are of uniform height. Measure the actual distance from the ground surface to the top of the brick cap on the planter wall. Divide these dimension by 4 to obtain the correct height for each riser and the corresponding height for the steps to be formed in the concrete base. With this information, the forming of the base can proceed.

Forming of the concrete base for the brick steps is indicated in Figure 68. Trim four lengths of 2" lumber to the height just determined for the risers and position these at the face edges of risers as shown in the figure. The top edges of these form boards are used as screed edges to form the steps when the concrete is placed. In placing the form boards, the correct position of the steps should be marked on the two opposite return walls with pencil or chalk. The riser forms then are held in place by means of wood blocks fastened temporarily to the return walls as indicated in the figure.

Brick pavers and risers are laid in mortar after the concrete has set up and forms are removed. The brick paving pattern shown in plan view in Figure 9 fits the modular size of the brick units, so no cutting of brick is required to the treads. Riser bricks must be cut to length of about 1/2" shorter than the step riser dimension. A cross section of the finished assembly is shown in Figure 69.

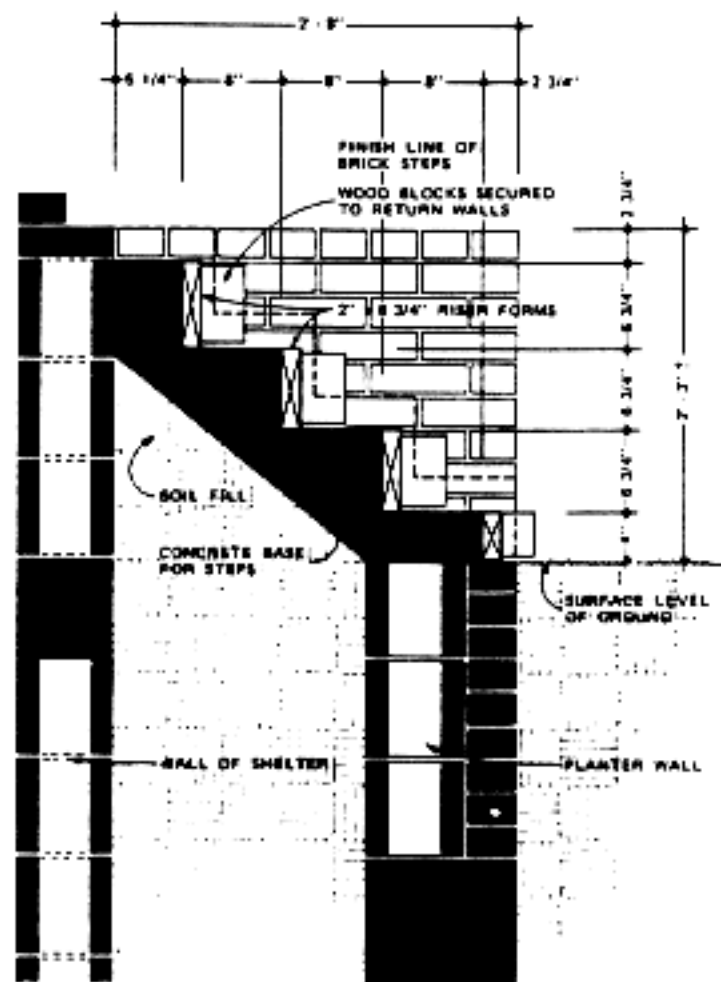

Figure 68. Cross section showing concrete base for brick steps

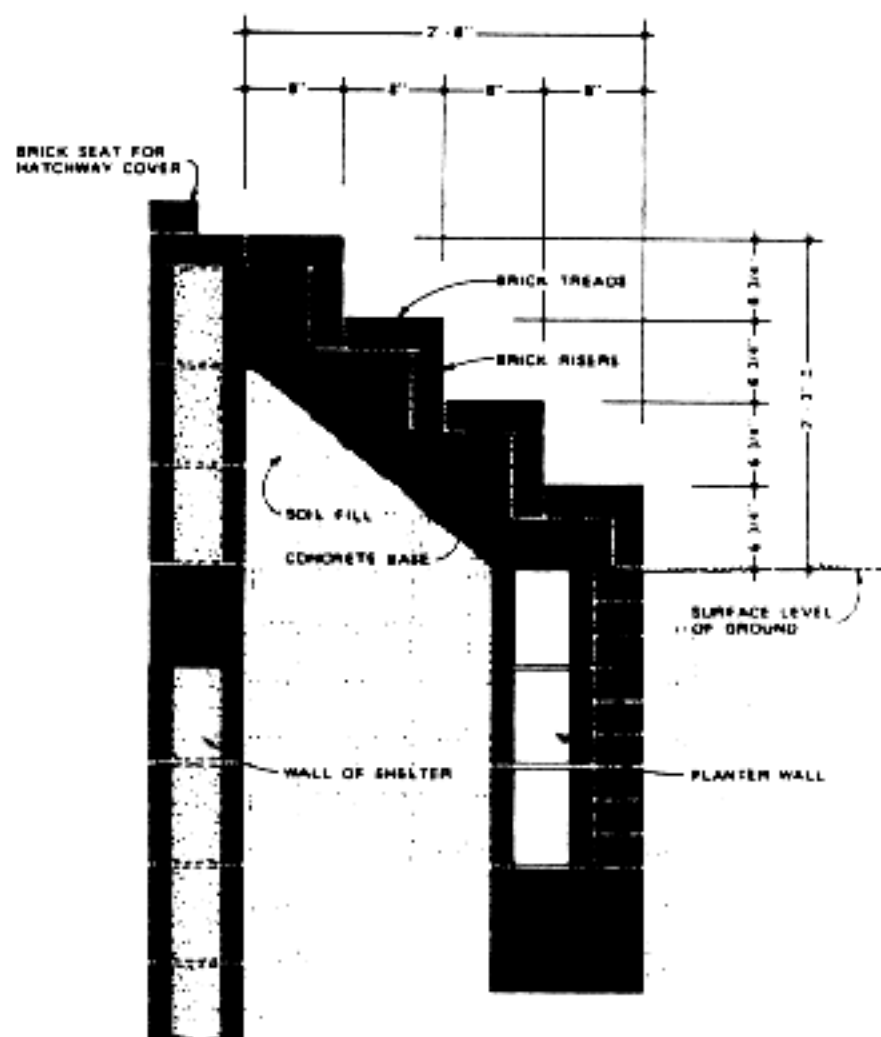

Figure 69. Cross section through brick steps



Entry to the home shelter is by means of a hatchway and stairs. The hatchway opening is protected from the weather with a wood-framed, metal clad cover which, because of its weight is in two sections for ease of operations. A simple stair, consisting of wood treads supported on wood strings, is provided. A hand rail is recommended for safety of occupants access and egress due to the relatively steep slope of the stairs (see Figure 10).

### HATCHWAY COVER

Construction details of the hatchway cover are indicated in Figures 12 and 13. The particular details were selected to provide long term durability of the wood cover in moist condition and to match the overall visual character of the facility.

The hatchway cover rests on a course of brick to elevate it above any water from rain, snow, or yard irrigation. The cover also is sloped in one direction to provide positive drainage of the surface. Wood framing layout, plywood deck, and sheet metal cladding material are indicated in the figures.

The covers operate on hinges which must be firmly secured to the masonry of the hatchway enclosure walls. Steel bars embedded in the masonry and with bolts pins are recommended at the hinged points (two for each section to resist the forces that will occur when the covers are opened and closed).

### STAIRS

Strings to support the stairs treads are cut from a pair of 2" X 12"s. Cutting dimensions are shown in Figure 70. Strings should be secured to concrete block side walls for stability of the stairs.

Stairs treads are cut from 2" X 8" lumber and nailed to the strings. Figure 71 indicates the plan dimensions of a typical tread. However, field dimensions of the actual hatchway opening should be taken and the cutting dimensions adjusted as required.

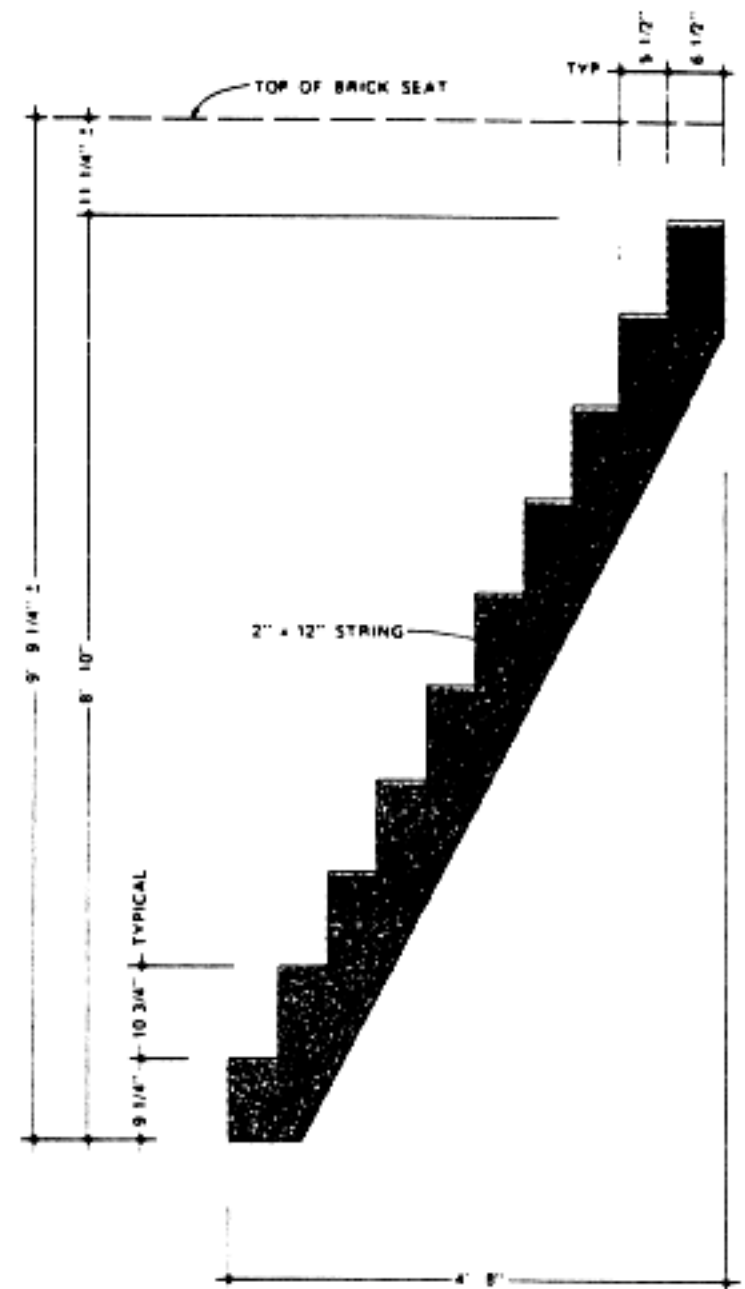

Figure 70. Elevation of stair string showing dimensions for cutting

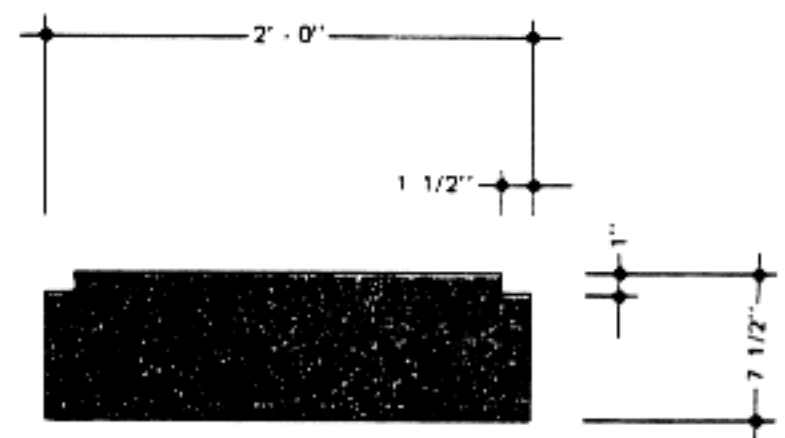

Figure 71. Plan of typical stair tread showing dimensions for cutting

## VENTILATION

Use of the facility as a fallout shelter or tornado shelter may require supplemental ventilation for extended use periods in some climates and during some seasons. Small, enclosed spaces having few openings and with several occupants sometimes do not provide adequate fresh air replenishment for breathing comfort and can become intolerably hot as a result of heat discharge by the occupants. Heat build up from occupants is likely to occur even when the occupants are sedentary.

Recognizing this problem, we recommend that shelter spaces without ordinary natural ventilation should be provided with some means of forced ventilation. The example below ground facility described in the booklet is a type for which supplemental ventilation should be provided.

The needed ventilation can be provided in more than one way. A hand operated fan can be purchased which provides an economical solution to meet the need. Alternatively, a small electrically powered blower may be installed. However, it should be recognized that electrical power may be disrupted during severe weather conditions or during radioactive fallout condition when the shelter most likely would be in use.

Installation of a ventilation system, whatever the type, requires certain components in order to operate properly. The following components should be installed during construction of the shelter, whether or not a blower fan is included at the time.

An air intake pipe from outside air to the fan connection point inside the space.

A hood at the outside end of the air intake pipe so that foreign material (such as fallout radiation) is not sucked through the pipe by the fan and dispersed into the shelter space.

An air exhaust pipe from the shelter space to the outside, located on a wall opposite the air intake pipe and fan, so that good air distribution is achieved.

Piping requirements and details of the air intake hood are shown in Figures 14, 15, and 16.

Use of the example facility as an emergency shelter requires no other mechanical system besides ventilation. Conveniences such as electric power, piped drinking water supply, and heating may be provided but are not necessary for occupant safety or survival.

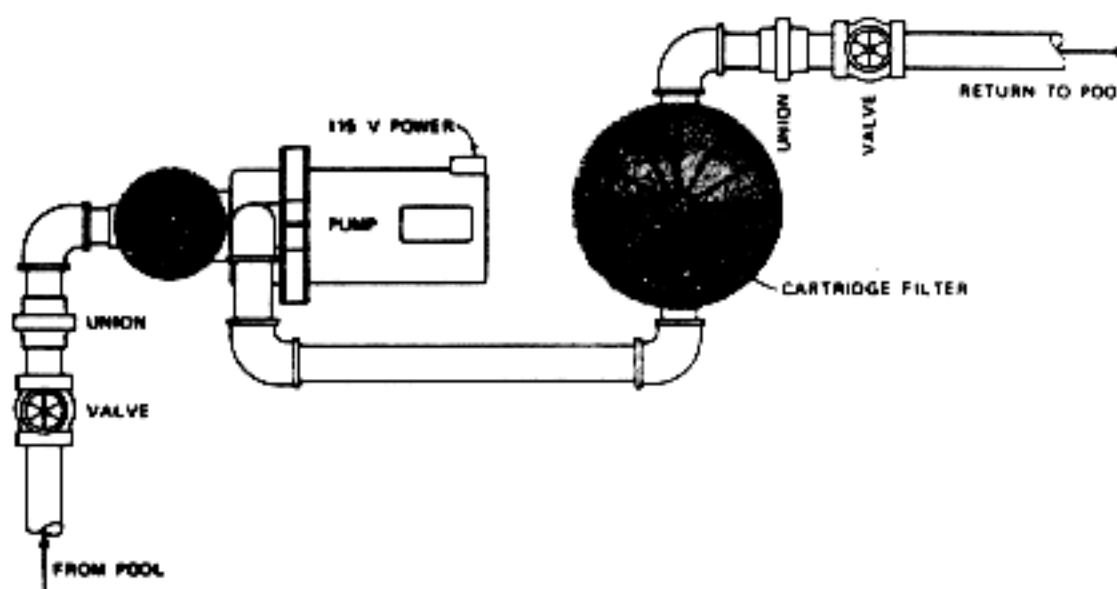

Figure 72. Schematic diagram of swimming pool filtration system

---

**LOCATION: SOUTHEASTERN UNITED STATES**

A swimming pool equipment house and tornado / fallout shelter similar to the one describe and illustrated in this booklet was constructed by a homeowner residing in Georgia. That shelter was the source of inspiration that led to development of this detailed guide for construction of a utilitarian facility that doubles as a protective shelter.

The homeowner of the shelter illustrated in this section constructed much of the facility by himself, using contractor services only for some of the heavier excavation and concrete work. He has aptly demonstrated that a suitable shelter can be built by a diligent, although novice homeowner / builder.

Most of the features of the shelter illustrated in previous pages of this manual are present in the example shelter described in the section. The construction details of the shelter illustrated in previous pages sometimes vary from those used in the owner built shelter largely so that standard construction practices are presented but the overall results are essentially the same for both examples.

The owner / builder constructed his facility without benefit of the detailed drawings and descriptions of construction procedures furnished in the manual. Much of his work was improvised from other information on home shelters published elsewhere. To that information about shelters, the owner / builder applied common construction practices plus a few of his own techniques to achieve the end result.

The owner-built shelter is located in the rear yard of the residence adjacent to a swimming pool where it has been integrated with yard landscaping. The only differences in appearance between the owner-built shelter and the shelter illustrated throughout this manual are the brick enclosures of the ventilation piping of the owner-built facility. These enclosures are purely decorative, however.

The owner-built shelter illustrates a new application of an older concept for protective shelters. Both tornado and fallout radiation protection require relatively massive construction that is most economically achieved by utilizing earthen as the protective mass. Underground earth covered construction affords a natural answer to the need for mass and readily meets the protective requirements. Hence, belowground shelters have been recommended frequently in the information published by the Federal Emergency Management Agency.

The innovative application of soil cover for the owner-built shelter lies in the integration of the underground protective shelter concept with the landscape of the yard. The raised, brick faced planter and its soil cover over the shelter that lies beneath are the principal features of this integration. Utilitarian use of the facility to accommodate equipment needed for a swimming pool is an added benefit.

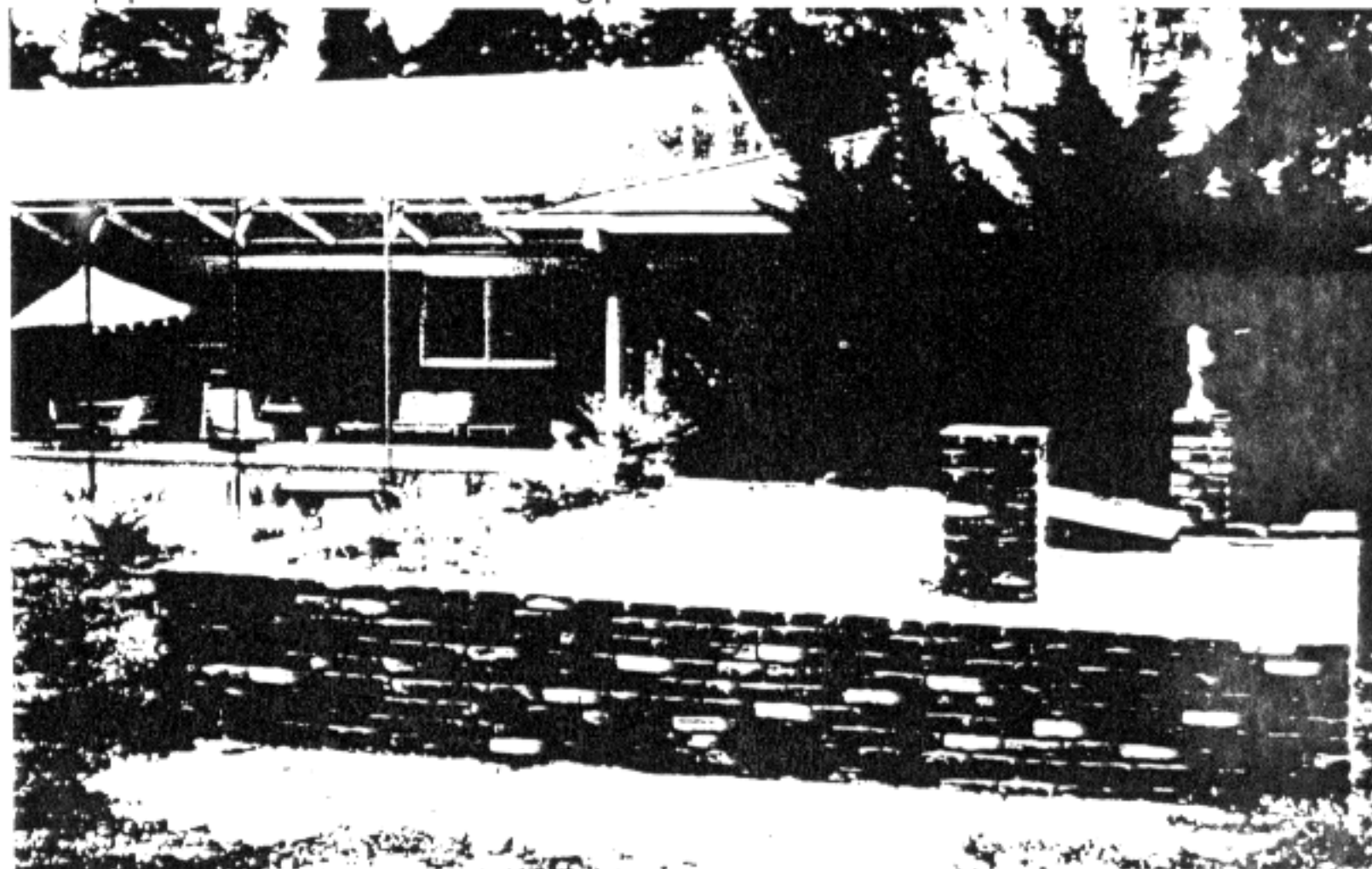

Figure 73. "As Built" Example of "Swimming Pool Equipment House and Shelter"



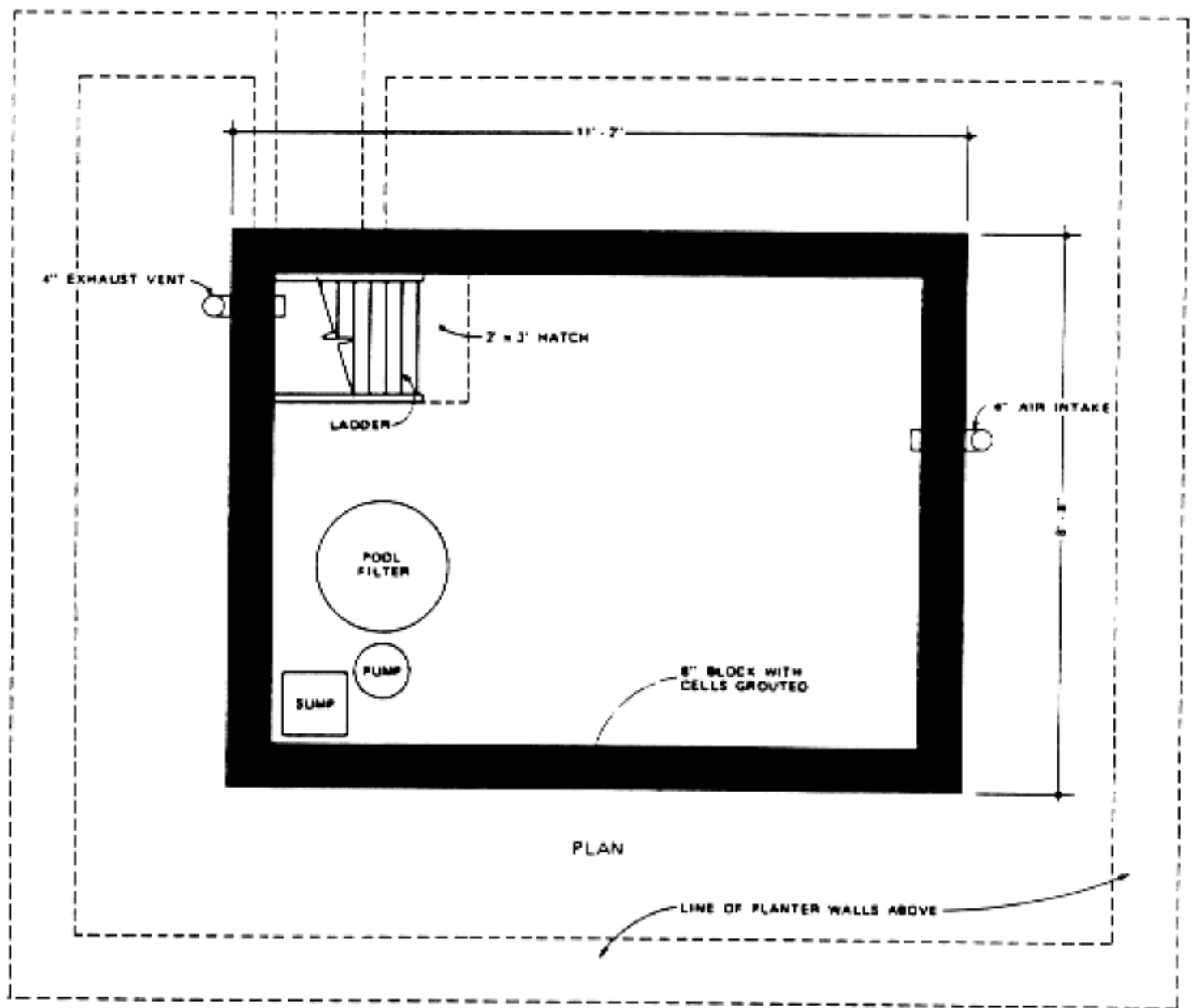

Figure 74. Plan of swimming pool equipment house and shelter

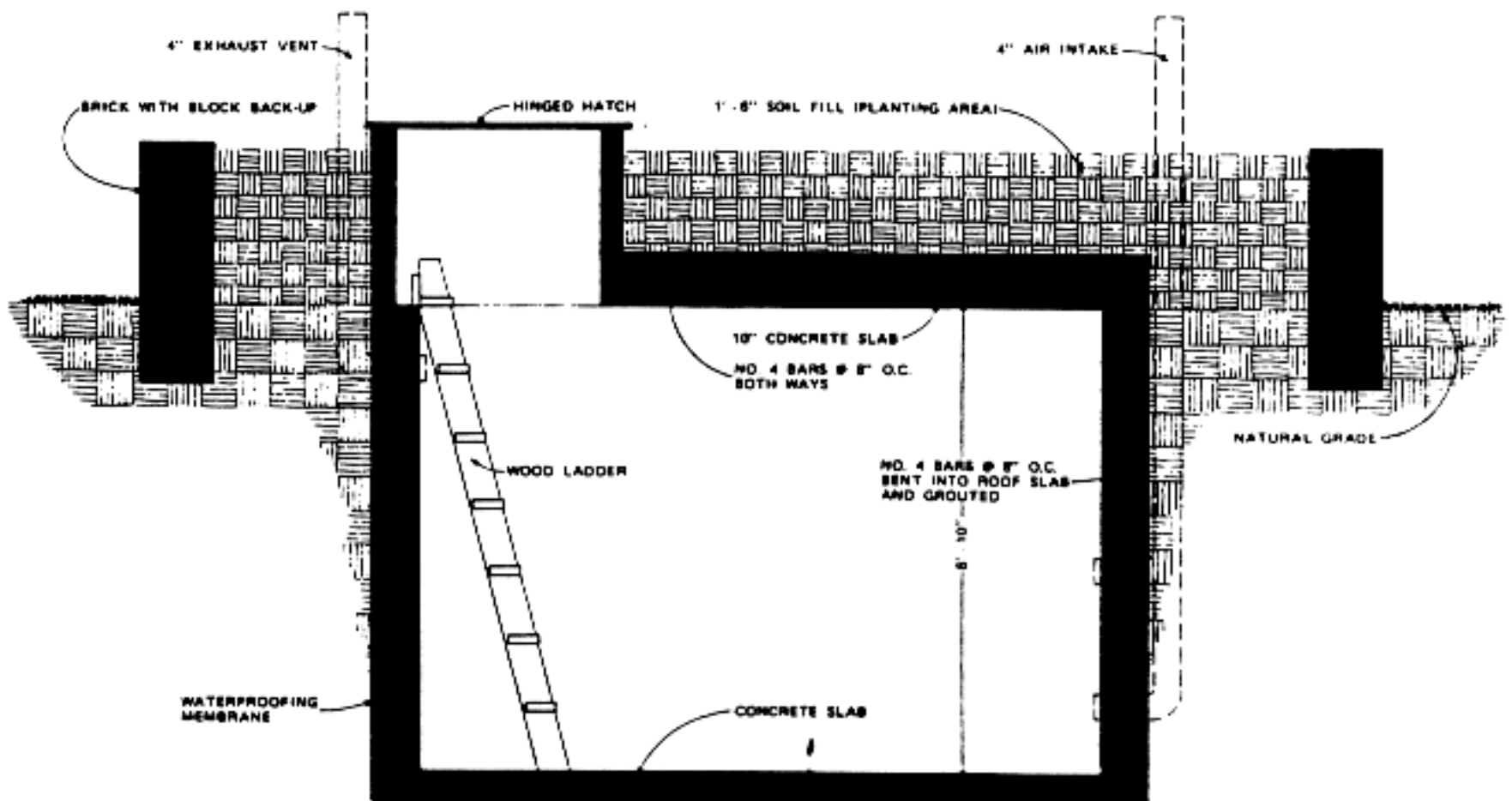

Figure 75. Cross section through the swimming pool equipment house and shelter

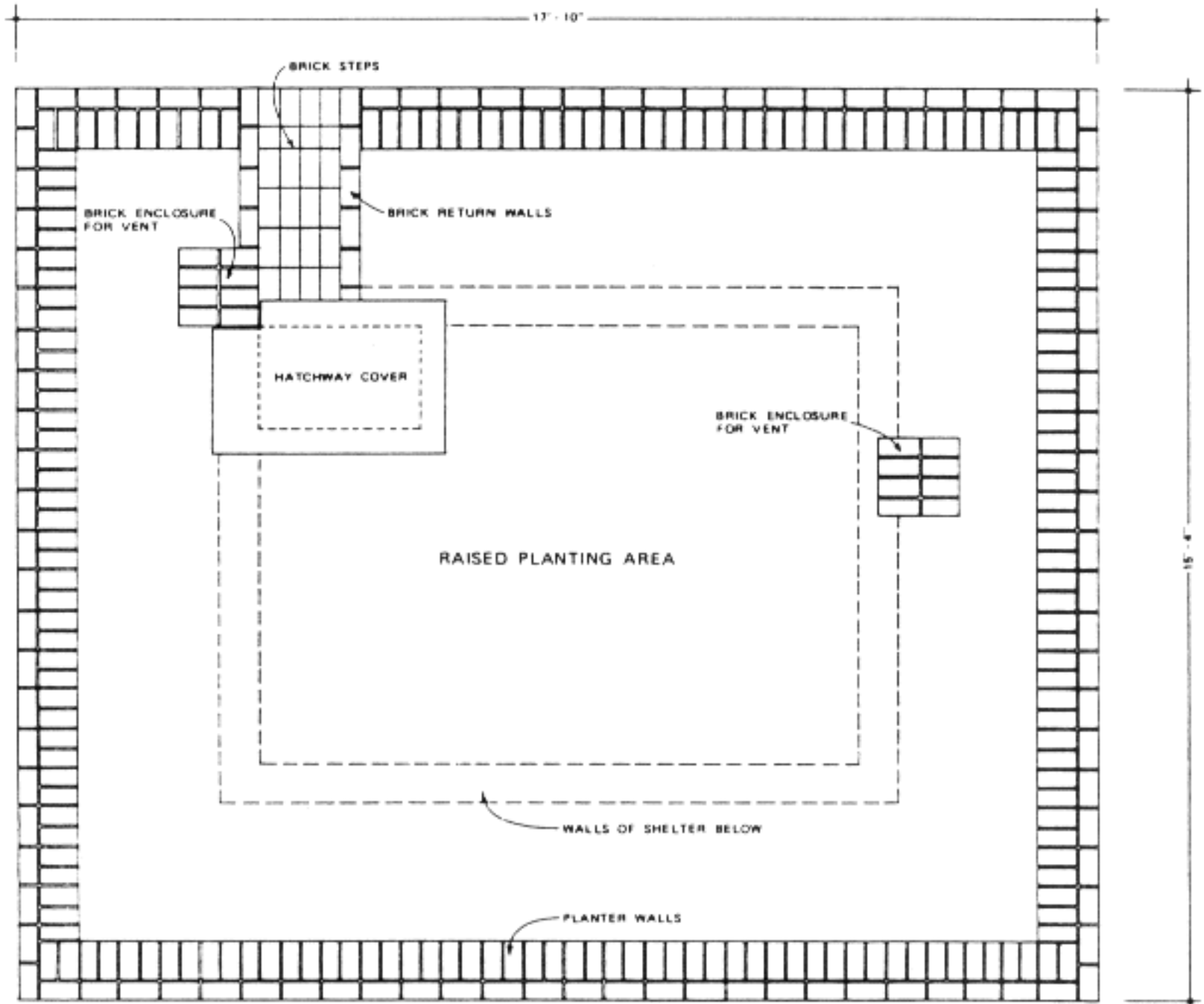

Figure 76. Yard level plan of brick planter of the swimming pool house

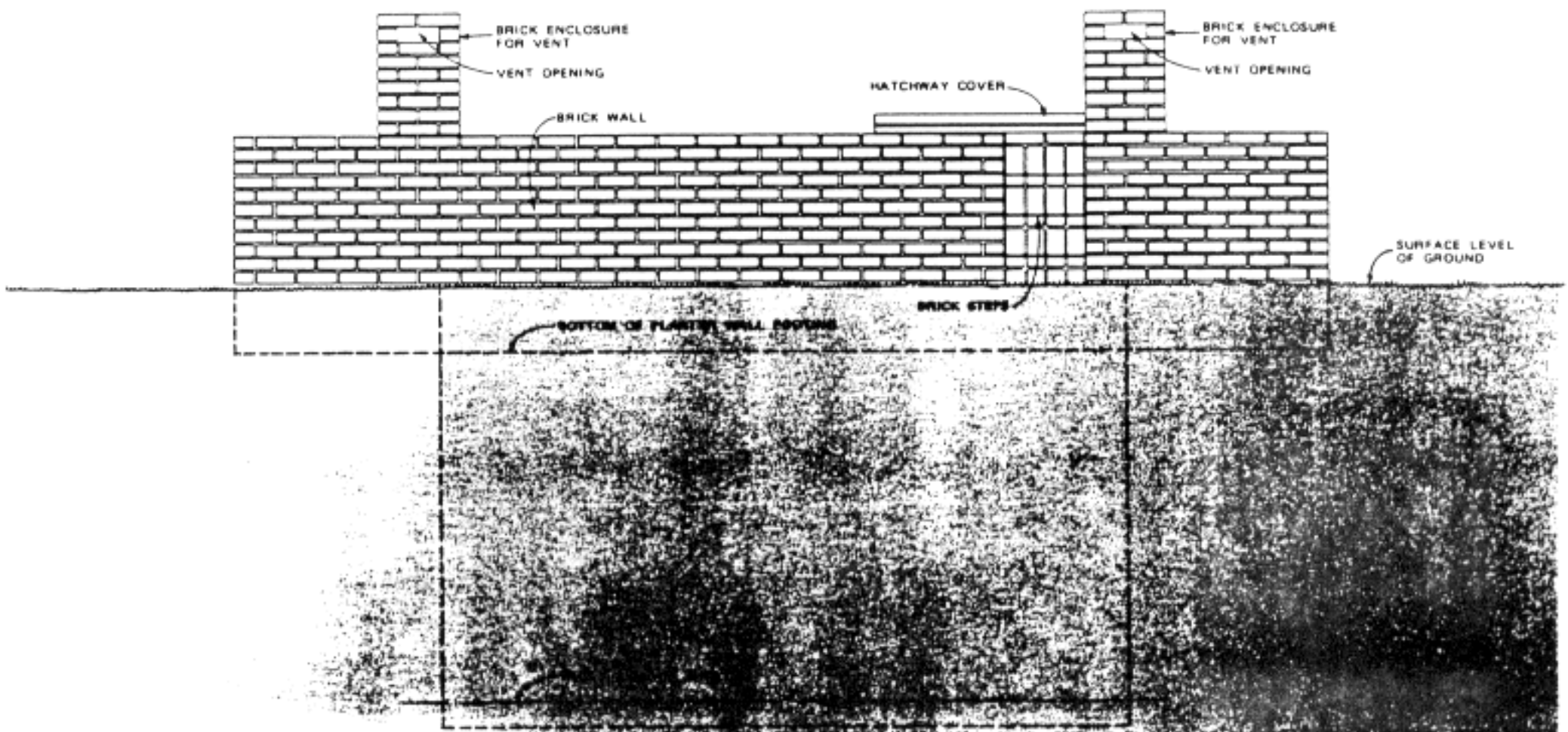

Figure 77. Elevation of swimming pool house at side with steps

Innovative application of the earth covered shelter concept is further evident in the construction details of the owner built facility. Foremost is use of the revised planter which not only reduced the excavation work without the loss of overhead soil cover needed for tornado and fallout radiation protection but also created the brick landscape feature in the yard that is comparable with the brickwork of the residence.

Plans, elevation, and section shown in the figures on pages 42 and 43 were prepared from field measurements of the as-built shelter. As noted, the owner built worked from incomplete plans provided from another type of shelter and made desired modification as he proceeded. Photos of the construction phases shown were taken by the owner-builder.

Although the owner-builder kept good data on cost for construction his facility in 1978, materials cost have increased drastically in recent years so much that the cost data furnished by the owner-builder are of little help in estimating the cost of construction a similar facility today. Total cost for the owner-built shelter, excluding brick work of the planter was \$1,271.

In this manual, specific cost information for the example shelter illustrated in previous pages has not been included. Instead, we have elected to furnish a relatively complete list of materials. With this list, each future homeowner / builder can obtain cost for materials and contractor services in his own area at current prices.

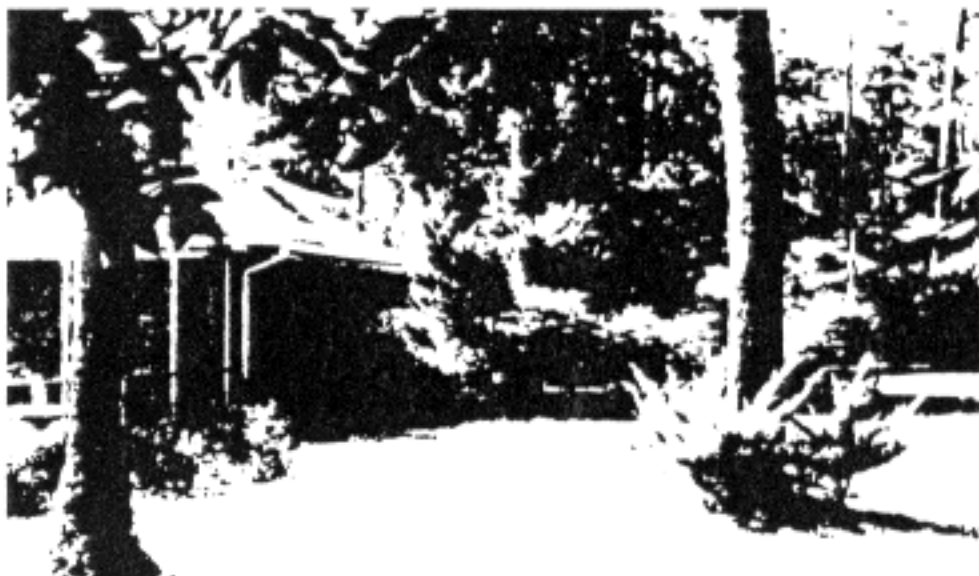

Figure 78. Out of Sight Out of Mind

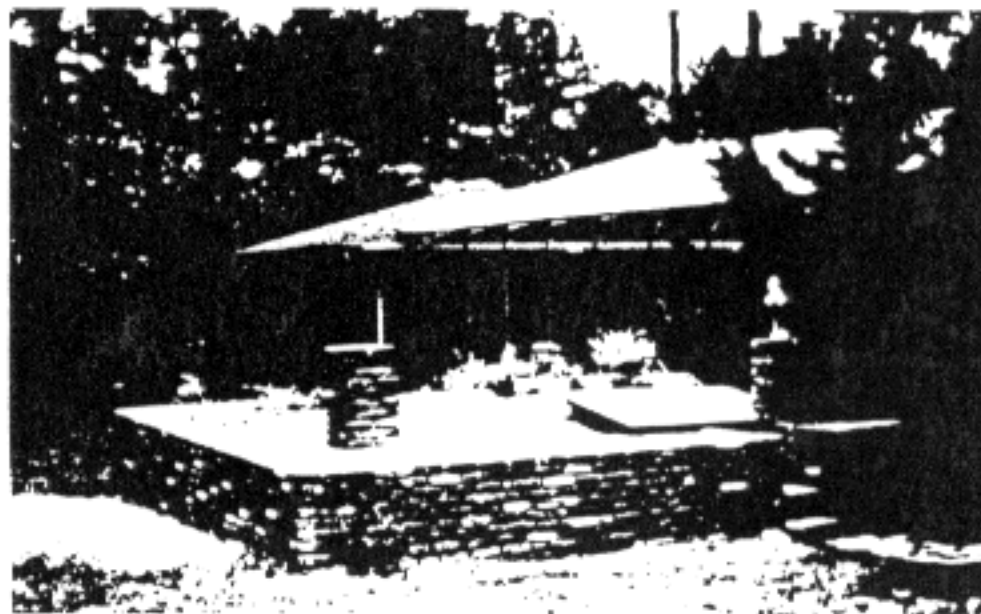

Figure 79. Brick laid up around ventilation piping

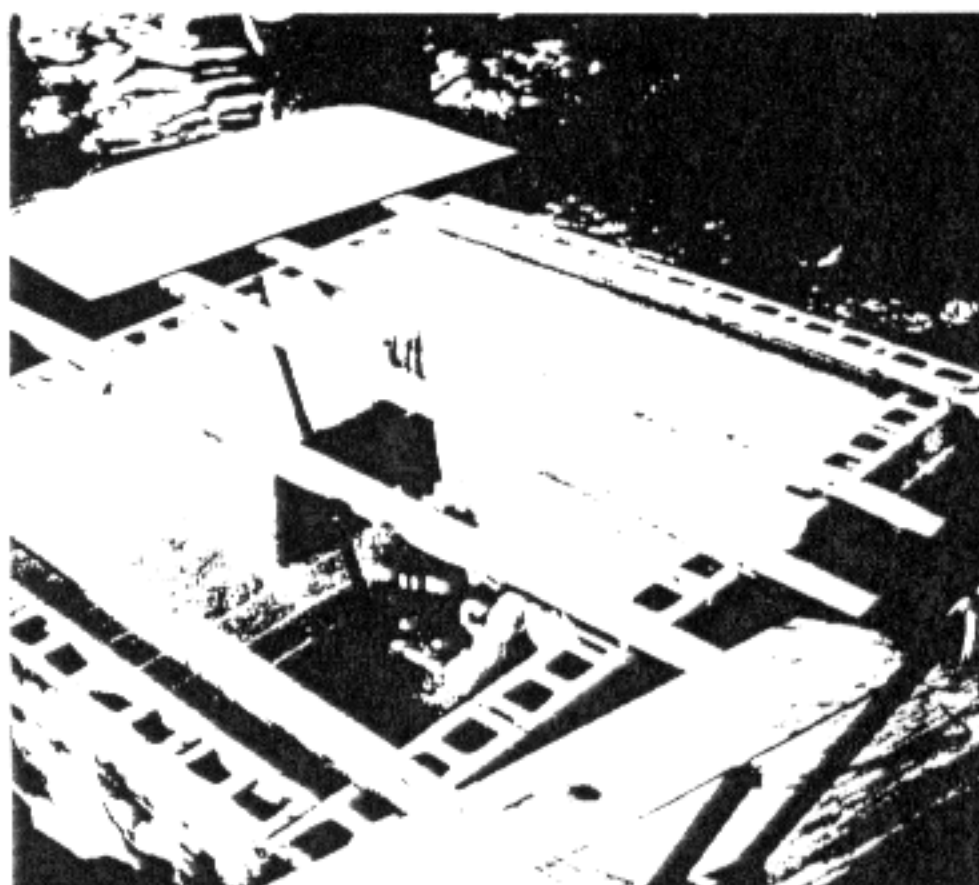

Figure 80. Construction photo before roof slab was formed

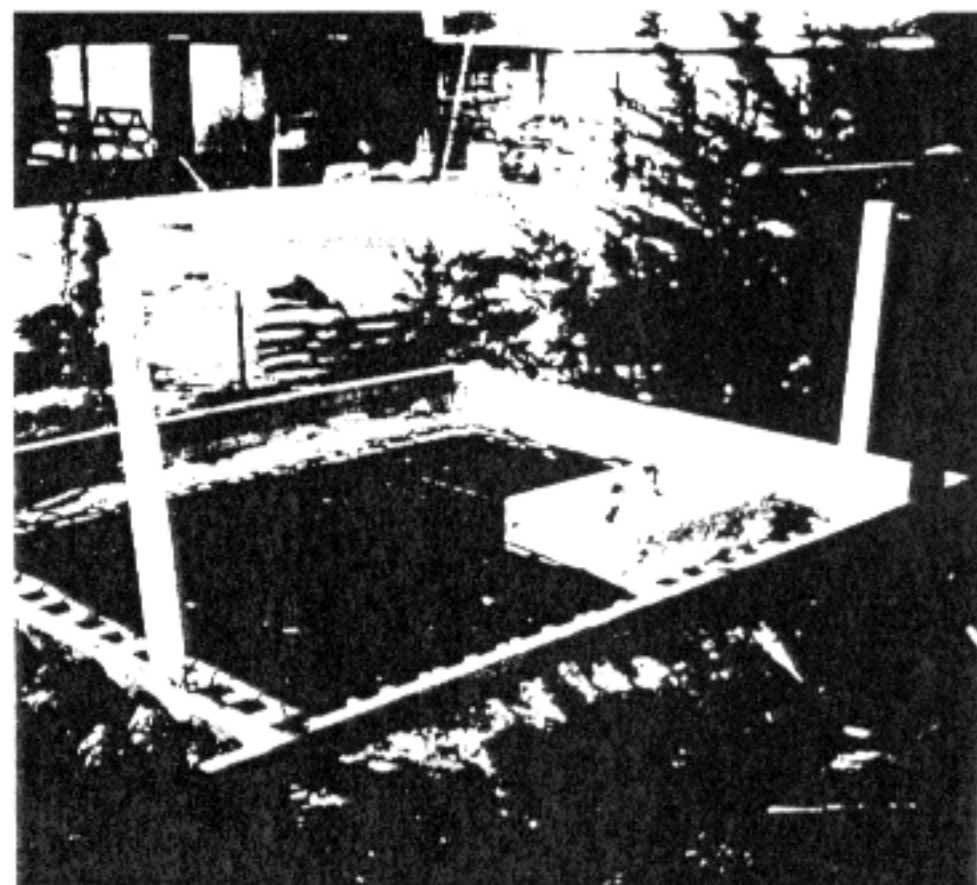

Figure 81. Construction photo steel in place ready to pour roof slab



# CHAPTER 4

---

## BELOWGROUND HOME FALLOUT SHELTER

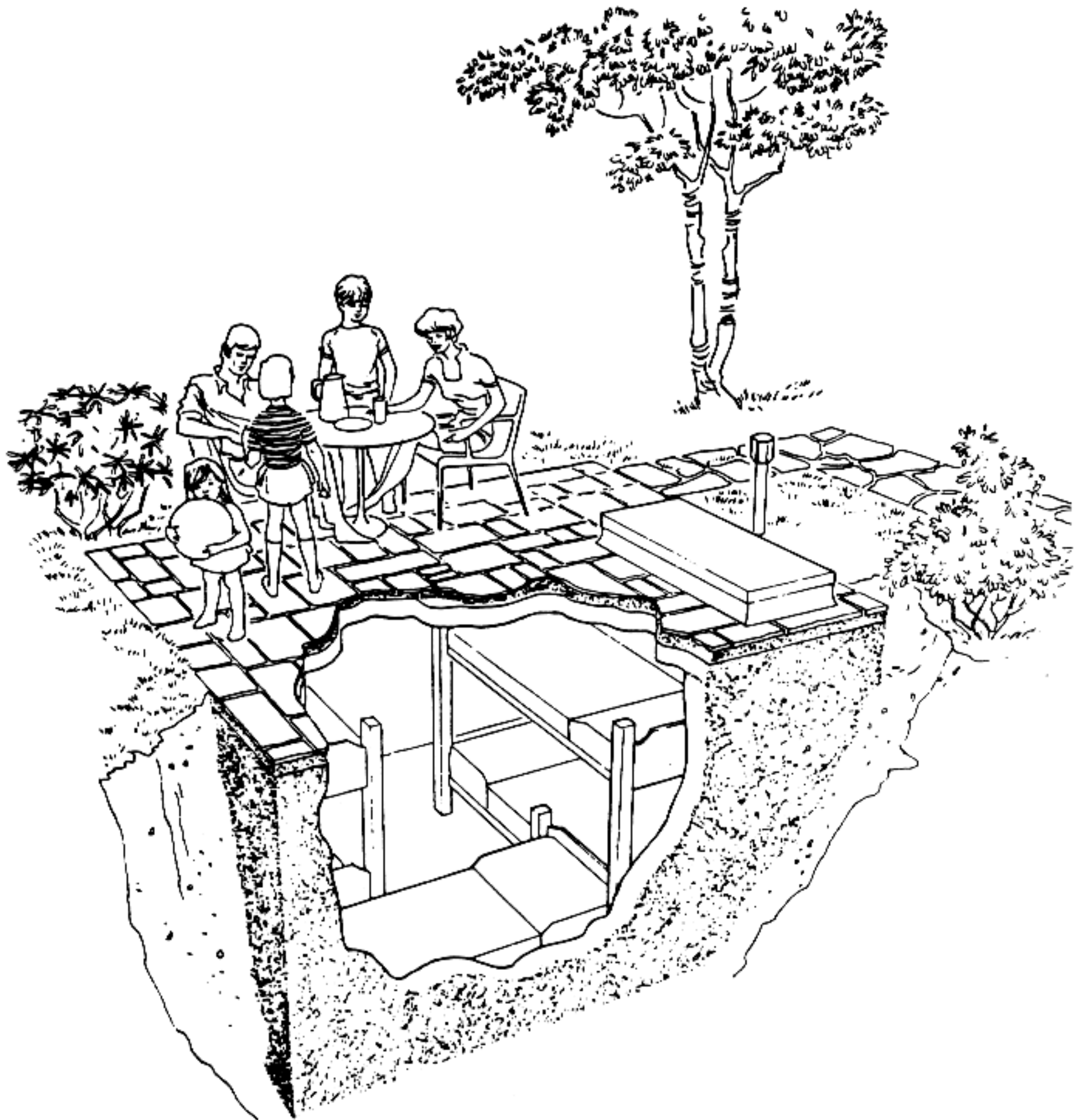

## GENERAL INFORMATION

This family fallout shelter, designed primarily for homes without basements, is a permanent home shelter to be placed in the yard. It provides a protection factor of at least 100. The minimum standard of protection for public shelters throughout the United States is a protection factor of 40. This design assures that persons inside the shelter will be protected against radioactive fallout following a nuclear attack, and will also have protection against earthquakes, hurricanes and tomadoes.

Following are detail drawings of the shelter, which is capable of housing six adults. It can be built of poured reinforced concrete, precast concrete slabs, or a combination of reinforced concrete blocks and poured concrete. If it is built as detailed with the top near ground level, the roof slab can be used as an outdoor patio. The shelter is accessible by a hatch-door and wooden stairway. Fresh air is provided by a hand operated centrifugal blower and two ventilating pipes that extend above ground level. In areas where there is poor drainage or where the ground water table is close to the surface, the fourth modification on page 72 may be used. Before starting to build the shelter, make certain that the plan conforms to the local building code. Obtain a building permit if required. If the shelter is to be built by a local contractor, engage a reliable firm that will do the work properly and offer protection from any liability or other claims arising from its construction.

## GUIDE TO CONTRACTS AND SPECIFICATIONS

It is generally advisable to have a written contract with your contractor, as well as technical specifications to supplement the drawing. A widely used and convenient contract form for construction of this size is the AIA Document A 107, "Abbreviated Form of Agreement Between Owner and Contractors for construction Projects of Limited Scope Where the Basis of Payment is a Stipulated Sum", copies can be acquired from the: American Institute of Architects, 1735 New York Ave., N.W., Washington, D.C. 20006. Sorry but it would be impractical to write a technical specifications to suit every local condition; however, the following summary of generally accepted construction materials and practices should be a useful guide.

## EXCAVATION

The excavation should have side slopes gradual enough to prevent caving, or appropriate shoring should be provided. Materials used for backfill and embankment should have debris, roots and large stones removed before placement. The subgrade for the floor slab should be level for ease in placing waterproofing membrane and to provide uniform bearing conditions for the structure. The area surrounding the patio should be sloped away at a minimum grade of 1 inch per 10 feet to provide good drainage.

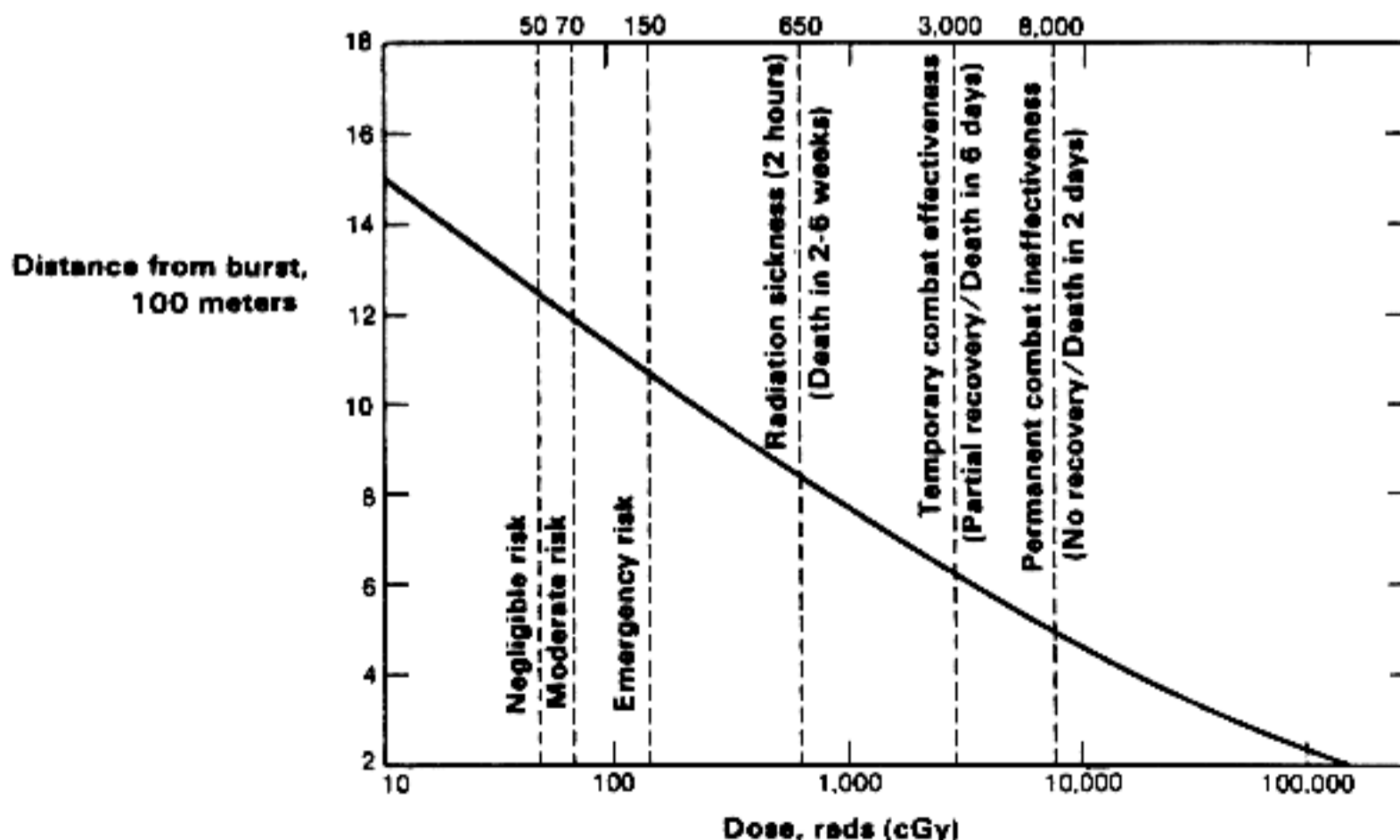

Relationship of radiation dose to distances from ground zero for a 1-KT weapon

## CONCRETE

For details of concrete construction, the "Building Code Requirements for Reinforced Concrete (ACI 318 - 83)" should be followed. This publication can be obtained from the American Concrete Institute, Box 19150, Redford station, Detroit Michigan 48219.

## OPTIONS

To accommodate additional persons, increase the shelter length 2' - 6" for each two (2) shelter spaces required. **DO NOT INCREASE THE (9' - 4" WIDTH)!**

Electrical service for lighting and outlets may be installed in the shelter from a separate residence circuit. A branch circuit breaker should be installed inside the shelter. Additional lighting and outlets may be provided from this circuit for the patio above.

An electric motor and pulley may be installed to operate the centrifugal hand crank blower by virtue of the electrical service option.

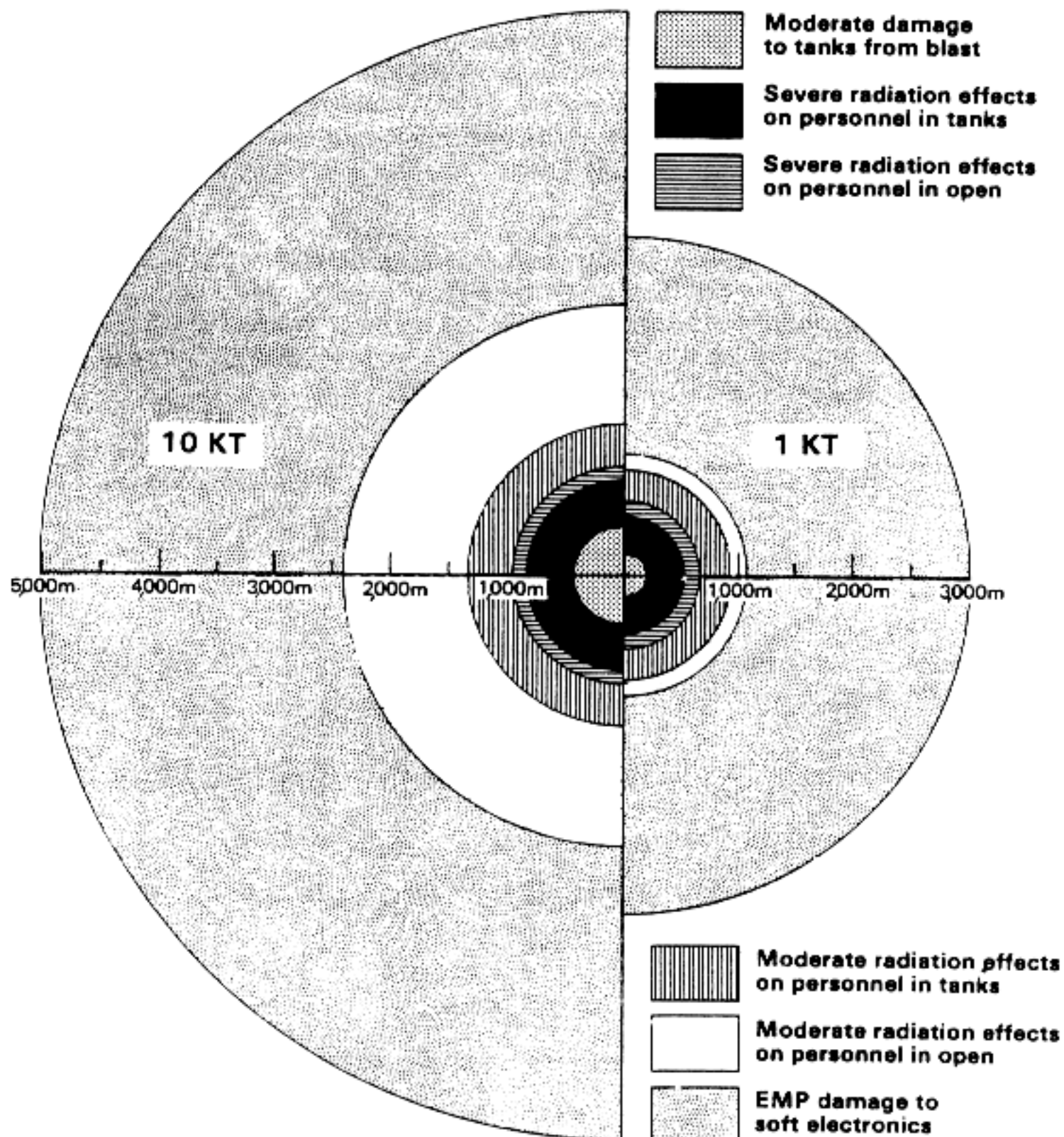

Effects of 1-KT and 10-KT fission warhead from a low airburst



## NOTES

Exterior walls, floor slab and under roof slab shall be waterproofed with a 3-ply membrane waterproofing system. This provides a continuous blanket which seals the entire area of surface to be protected. The membrane shall be protected from backfill damage and when completing other stages of construction.

Place flag stones or bricks on a sand bed when using the roof slab as a patio.

There are a number of commercially produced metal roof hatches that will adequately serve as a shelter door. However, as long as the door is weatherproofed and durable, a homemade, galvanized sheet metal covering wood door is suitable.

Bevel all exposed corners of concrete  $3/4"$  at 45%.

Structural design data:

Steel = Grade 40

Concrete = 2,500 psi

Soil (minimum) = 600 psf, to withstand downward pressure

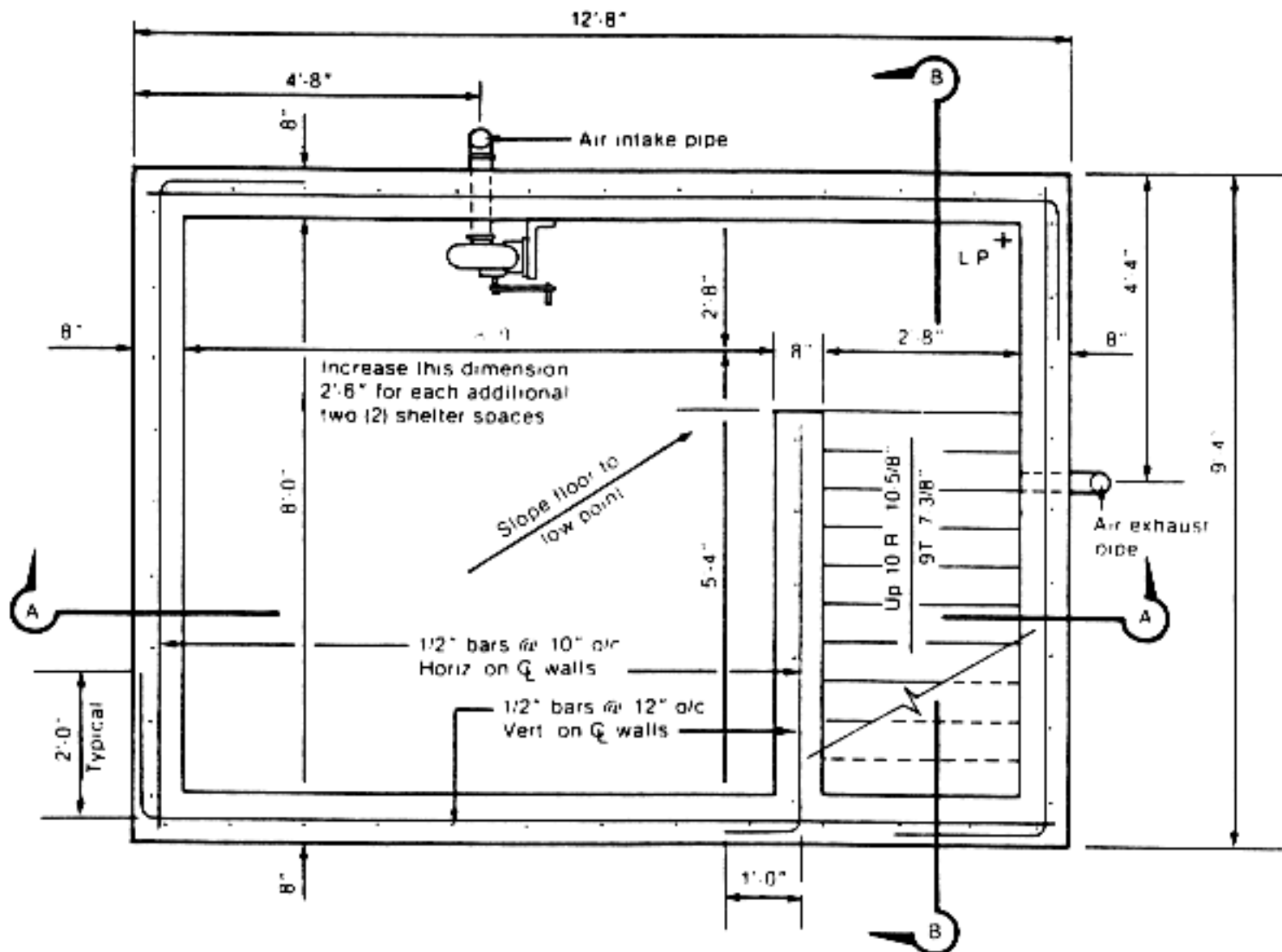

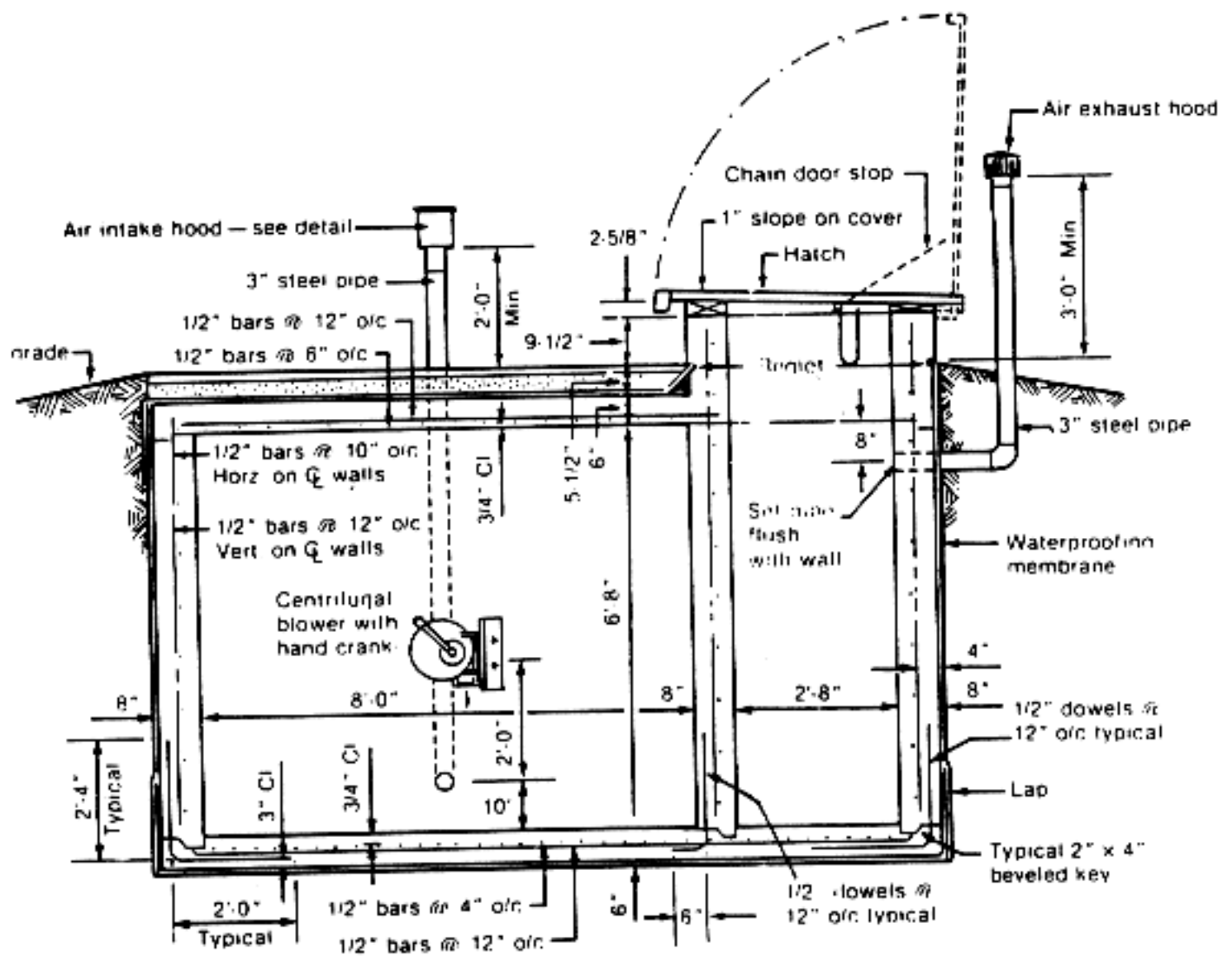

Section A - A

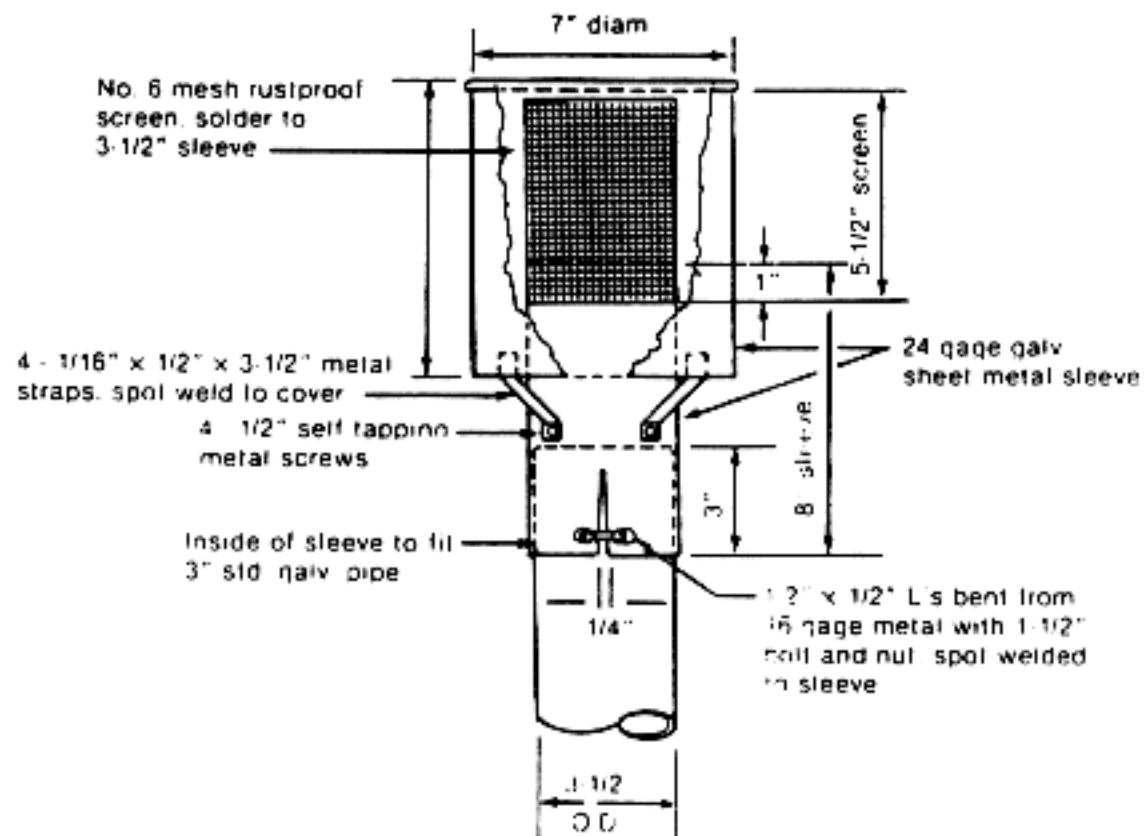

Air Intake Hood Details

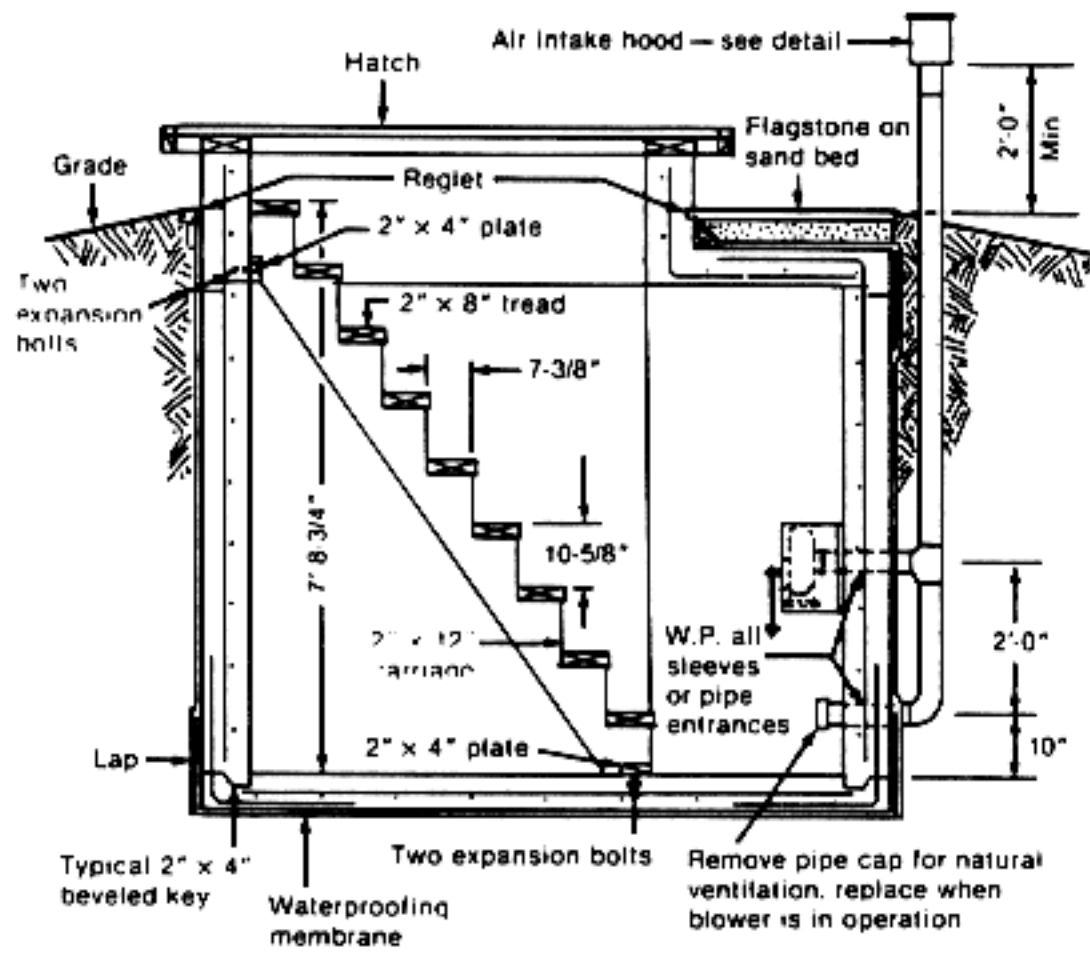

Section B - B

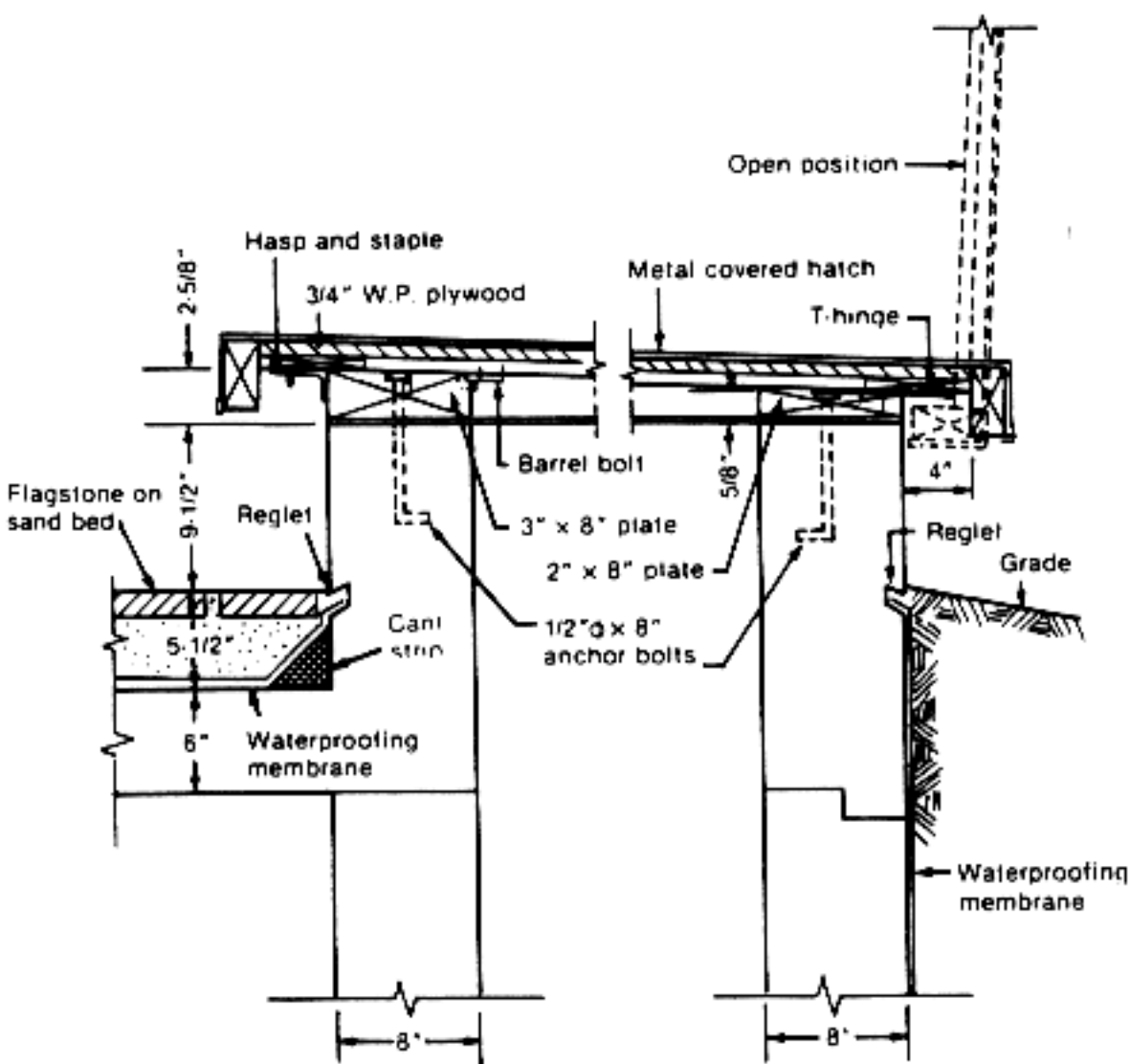

Hatch Detail

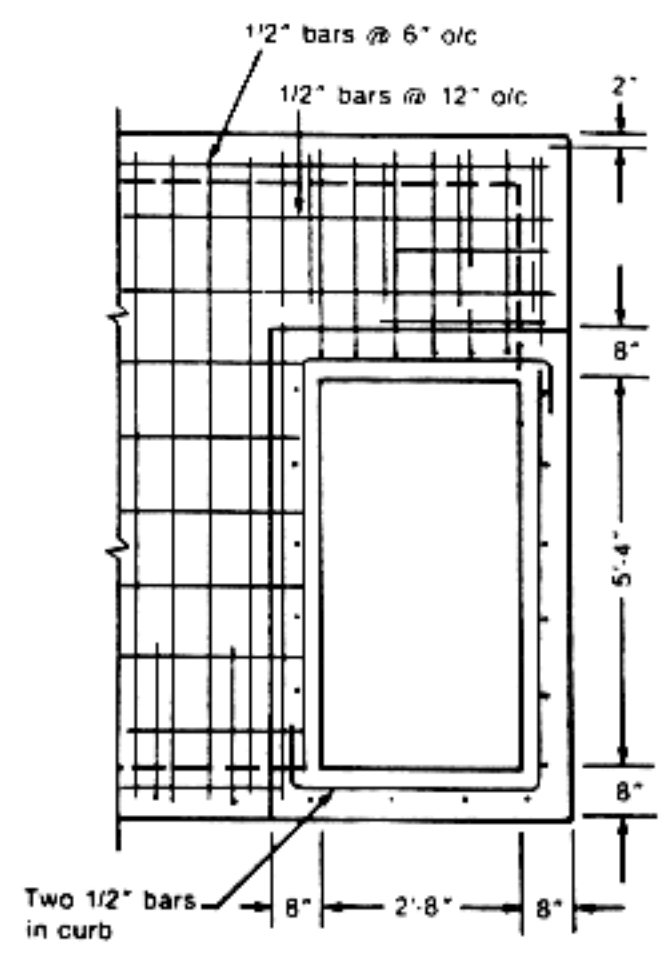

Hatch Framing



## POSSIBLE VARIATIONS

This first variation utilizes 12 - inch reinforced concrete masonry units for walls instead of reinforced concrete. The floor, roof and entrance way are the same as in the basic shelter, and the amount of protection provided is essentially the same.

If a basement is available, the shelter may either be separate from it, or attached. In this variation, an attached shelter is entered through the basement of the house, thereby permitting dual use of the shelter space. Other advantages of this modification include flexibility of shape and design to conform to the house design and the use of the same kind of building materials as used in the construction of the house.

If the topography permits, the shelter can be built into a hillside or embankment. This modification increases the protection factor by the addition of an earth mound over the shelter. A maximum of 3 feet of earth cover is recommended.

The principal advantage of this shelter modification is that it can be erected with a minimum of excavation in locations where there is poor drainage or where the ground water table is close to the surface. However, the exposure of the shelter above ground requires the addition of earth mounding around all sides.

This shelter modification permits the design and construction of a shelter with a fairly small hatch entry. The iron rungs placed in the concrete wall will also maximize the usable area.

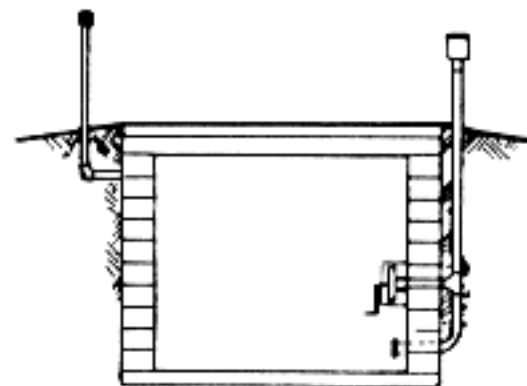

SECTION

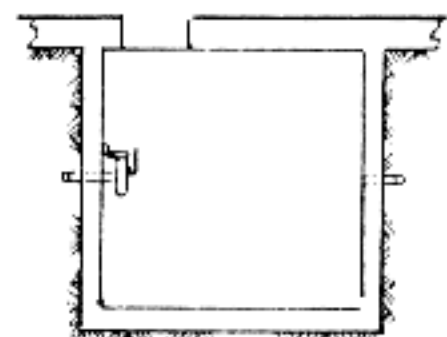

PLAN

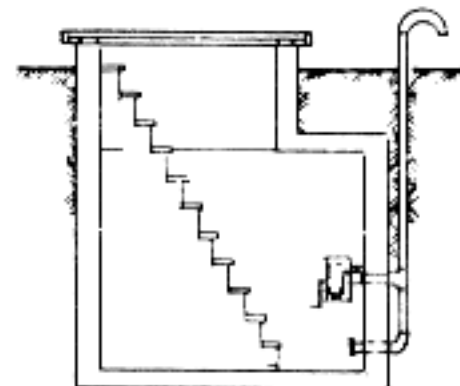

SECTION

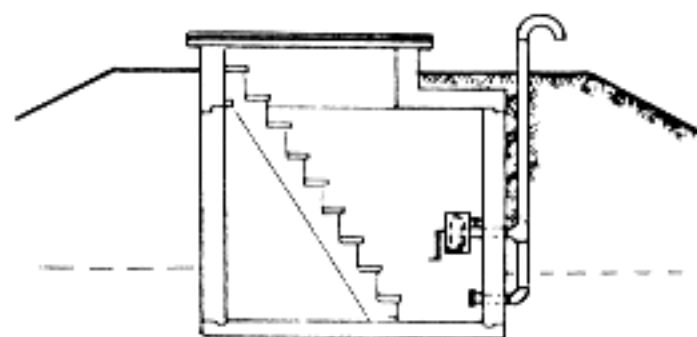

SECTION

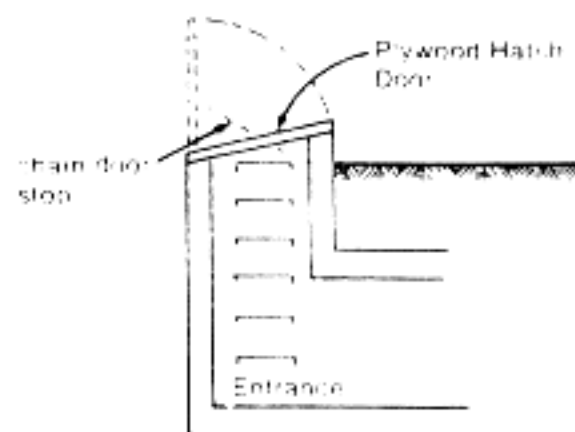

# LIST OF MATERIALS

## CONCRETE

Floors	60 cu. ft.
Walls	235 cu. ft.
Roof	50 cu. ft.
	345 cu. ft.

## STEEL REINFORCING

FLOOR WALLS ROOF	Total 13 cu. yds.
	580 lin. ft.

## MISCELLANEOUS

MISCELLANEOUS:	945 lin. ft.
Tie wire - 6" coils	260 lin. ft.
Hand blower w / mounting brackets	1
3" galv. steel pipe	16 lin. ft.
3" galv. ells	2
3" galv tee	1
3" galv cap	1
Intake hood w / screen	1
Exhaust hood, w / screen	1
Wood carriages, 2" X 12" X 10'	2
Wood treads, 2" X 8" X 2' - 8"	9
Wood plates, 2" X 4" X 2' - 8"	2
Hatch door, metal covered	1
Wood plate, 2" X 8" X 7'	1
Wood plate, 3" X 8" X 14'	1
T - hindses, 8" X 5 1/2" E.H., galv.	3
Hasp and staple, galv.	1
Chain door stop, galv.	1
Anchor bolts, 1/2" CI X 8"	8
Expansion sheilds and bolts, 3/8' CL X 4"	4
Waterproofing membrane	715 sq. ft.
Flagstone	100 sq. ft.
Sand	1.5 cu. yds.
Cant strip	12 lin. ft.

FORM WORKING AND MATERIALS NOT INCLUDED

# CHAPTER 5

---

## BELOW GROUND REINFORCED BLAST SHELTER

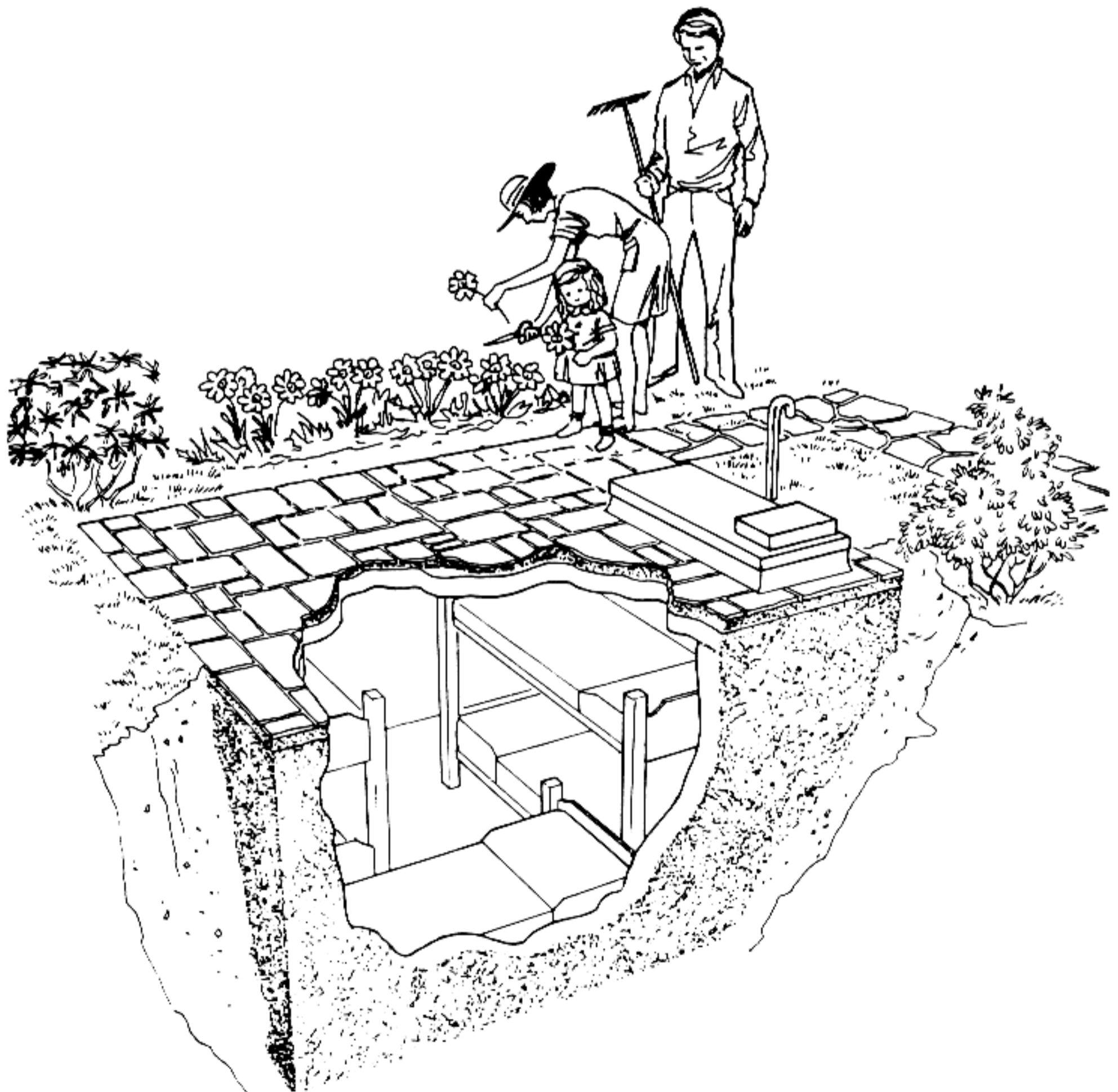



## GENERAL INFORMATION

This family blast shelter can be placed in the yard and will provide protection against thermal effects, fallout radiation, and blast effects from a nuclear weapon. It is designed to accommodate six adults. This shelter will also provide excellent protection against tornadoes. It has a protection factor greater than 100. The minimum standard of protection from fallout radiation established by the Federal Emergency Management Agency for public shelters is a protection factor of 40. It will withstand blast overpressures of up to 15 pounds per square inch (psi). If it is built as detailed, with the top near ground level, an outdoor patio can be constructed above the roof slab. The shelter is accessible by a hatch door and wood stairway. Fresh air flow is provided by the hand operated centrifugal blower and two ventilating pipes that extend above ground level.

The blast effect from a nuclear weapon is a wave of air, at high pressure, moving outward from the explosion. The moving air is strong enough and lasts long enough to destroy buildings out to a distance of several miles. Ordinary homes will be damaged or destroyed by the blast pressure if it exceeds two pounds per square inch. At 15 psi peak overpressure, homes will be reduced to rubble and there could be fires and smoldering debris.

People can be killed or injured by blast in three ways; First, the blast pressure acts directly on weaker parts of the body such as the lungs and eardrums; second, it hurls pieces of debris about at such speeds that they can kill or injure; and third, it can throw persons against solid objects. Protection from the effects of blast can be provided only by structures strong enough to resist the blast wave. Occupants of a shelter can be killed or severely injured if excessive blast pressures enter the shelter. A good blast shelter must have the opening sealed to keep out the blast wave, as well as smoke and toxic fumes.

The shelter has a wood main hatch cover and a smaller wood access hatch cover, both of which are hardened to prevent the blast wave from entering. The main hatch cover weighs about 500 pounds and would be opened only when needed to move furniture and equipment in and out of the shelter. The main hatch cover is held in place by load binders (five on each of the sides). People enter and leave the shelter through the access hatch opening in the main hatch. The access hatch cover is hinged and weighs about 100 pounds. It also is held in place by load binders (two on each of the long sides).

The ventilation piping includes a gate valve and pipe cap on the air intake, and a pipe cap for the air exhaust, to prevent the blast wave from entering the ventilation system. During normal periods, the pipe caps on both the air intake and exhaust should be removed. This will permit some natural ventilation and help keep the shelter dry. When the blast shelter is to be used for protection, both caps should be placed on the air intake and exhaust, and the gate valve closed for the blower, to prevent the blast wave and smoke from entering. As soon as the blast wave has passed over the shelter, the gate valve to the blower can be opened, the pipe cap of the air exhaust removed, and the blower started. If smoke contaminates the air around the air intake, it will be necessary to delay removal of the pipe caps, and blower operation. To prevent fallout particles being pulled into the shelter through the air intake, an optional air intake hood can be stored in the shelter and installed after the blast.

If the attack does not occur at the time that shelter has been occupied for about 2 hours, the ventilation system should be operated for about 15 minutes to provide fresh air in the shelter. The ventilation system should then be closed again and the cycle repeated until either the blast wave has passed over the shelter (detected by a shaking movement) or the danger of attack has ended.

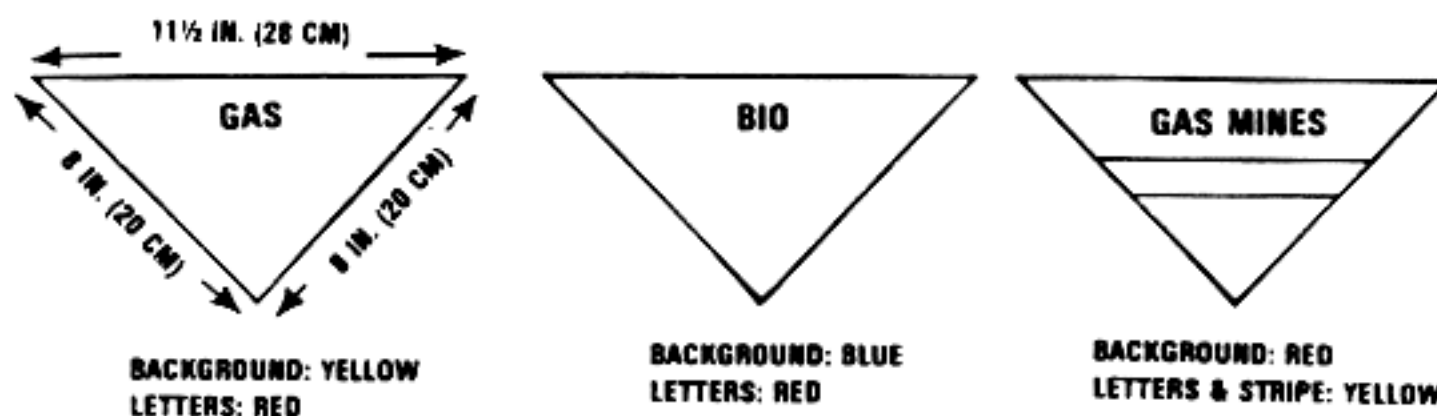

Before building the shelter, make certain that the design conforms to the local building code. Obtain a building permit, if required. If the shelter is to be built by a local contractor, engage a reliable firm that will do the work properly, offer protection from any liability or other claims arising from its construction, and will guarantee workmanship and materials for a period of at least one year.

### **DRAWINGS**

The drawings on page 79 through 83 show the details of the shelter. With these drawings, a contractor can build the structure. Individuals who may not be able to read and understand the designs and plan to construct their own shelter may require outside assistance.

### **GUIDE TO CONTRACTS AND SPECIFICATIONS**

It is generally advisable to have a written contract with your contractor as well as technical specifications to supplement the drawing. A widely used and convenient contract form for constructing of this size is the AIA Document A 107, "Abbreviated form of Agreement Between Owner and Contractor for Construction Project of Limited Scope Where the Basis of Payment is a Stipulated Sum," which is available from the American Institute of Architects, 1735 New York Ave., N.W., Washington, D.C. 20006. It would be impractical to write a technical specification to suit every local condition; however the following summary of generally accepted construction materials and practice should be a useful guide.

### **EXCAVATION**

The excavation should have side slopes gradual enough to prevent caving, or appropriate shoring should be provided. Materials used for backfill and embankment should have debris, roots and large stones removed before placement. The subgrade for the floor slab should be level for ease in placing waterproofing membrane and to provide uniform bearing condition for the structure. The area surrounding the patio should be sloped away at a minimum grade of 1 inch per 10 feet to provide good drainage.

### **CONCRETE**

For details of concrete construction, the "building Code Requirements for Reinforced Concrete (ACI 318 - 83)" should be followed. This publication can be obtained from the American Concrete Institute, Box 19150, Redford Station, Detroit, Michigan 48219.

### **WATERPROOFING**

Waterproofing specifications may be obtained from the nearest Department of Housing and Urban Development offices; or those of a reputable manufacturer of waterproofing materials may be used. *Special attention* should be given to assure good waterproofing materials are being used and the contractor should guarantee it for a period of at least 5 years.

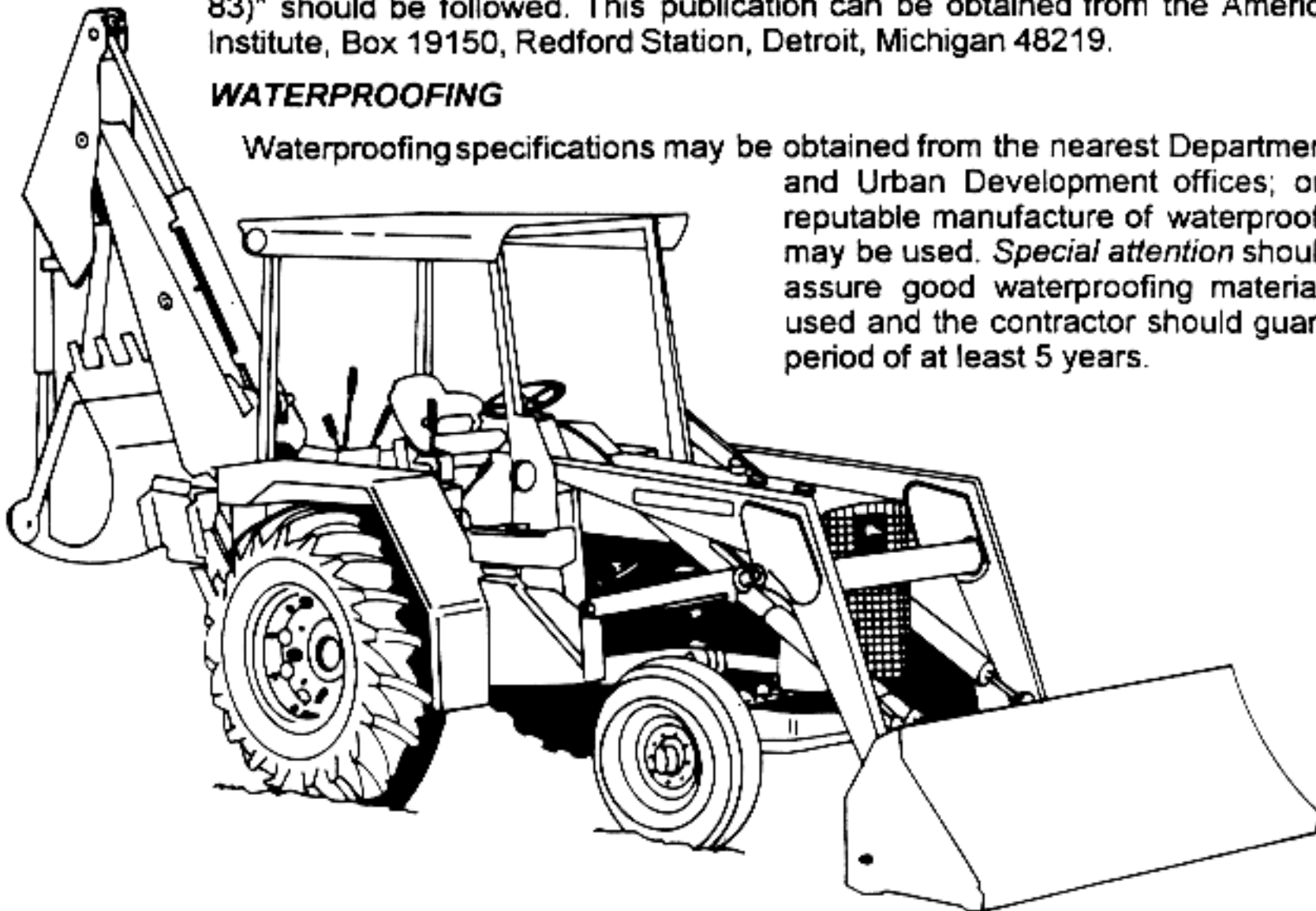

## VENTILATION

All pipe and fittings shall be galvanized. Suitable ventilating blowers and roof ventilators are available from many sources of supply. Fabrication details and installation requirements will differ. Blowers having geared, hand crank drives (motorized available) can be obtained from the following commercial sources:

- ☞ TEMET U.S.A., INC P.O. BOX 439, Great Falls, VA 22066
- ☞ LUWA Ltd. U.S. Office 4400 East West Hwy., #229, Bethesda, MD 20814
- ☞ CENTAUR FORGE Ltd. P.O. BOX 340, 117 N. Spring St. Burlington, WI 53105
- ☞ TEXAS AIR HANDLERS P.O. BOX 851256. Richardson, TX 75085

The names of specific manufactures of equipment are given only as examples, and do not denote a preference for their products or that other equally suitable items are not available.

The optional air intake hood can be fabricated by a local sheet metal shop in accordance with the details included in my manual.

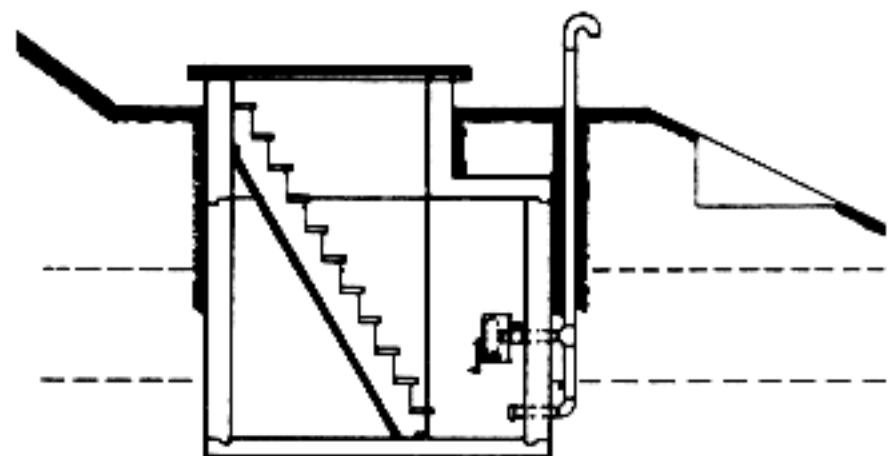

## VARIATIONS

If the topography permits, the shelter can be built into a hillside or embankment. This modification can increase the protection factor further by the additional earth mound over the shelter. A maximum of 3 feet of earth cover is recommended. The minimum cover for the shelter is shown on the detailed drawings. On the downhill side, a maximum slope of 1 on 2 is recommended within 18 feet of the shelter. There are no restrictions on the slope on the uphill side.

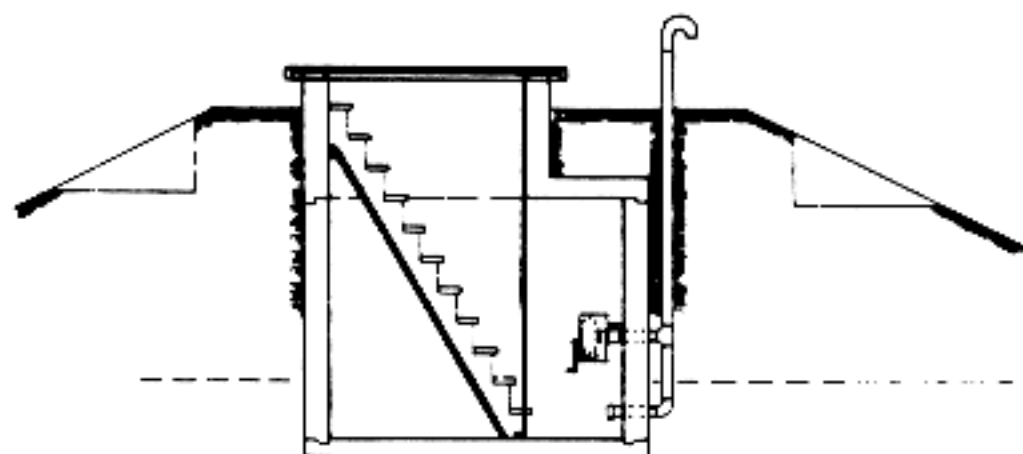

The principle advantage of this shelter is that it can be erected with a minimum of excavation in locations where there is poor drainage or where the ground water table is close to the surface. However, the exposure of the shelter above ground requires the addition of earth mounding around all sides. A maximum slope of 1 on 2 is recommended within 18 feet of the shelter.





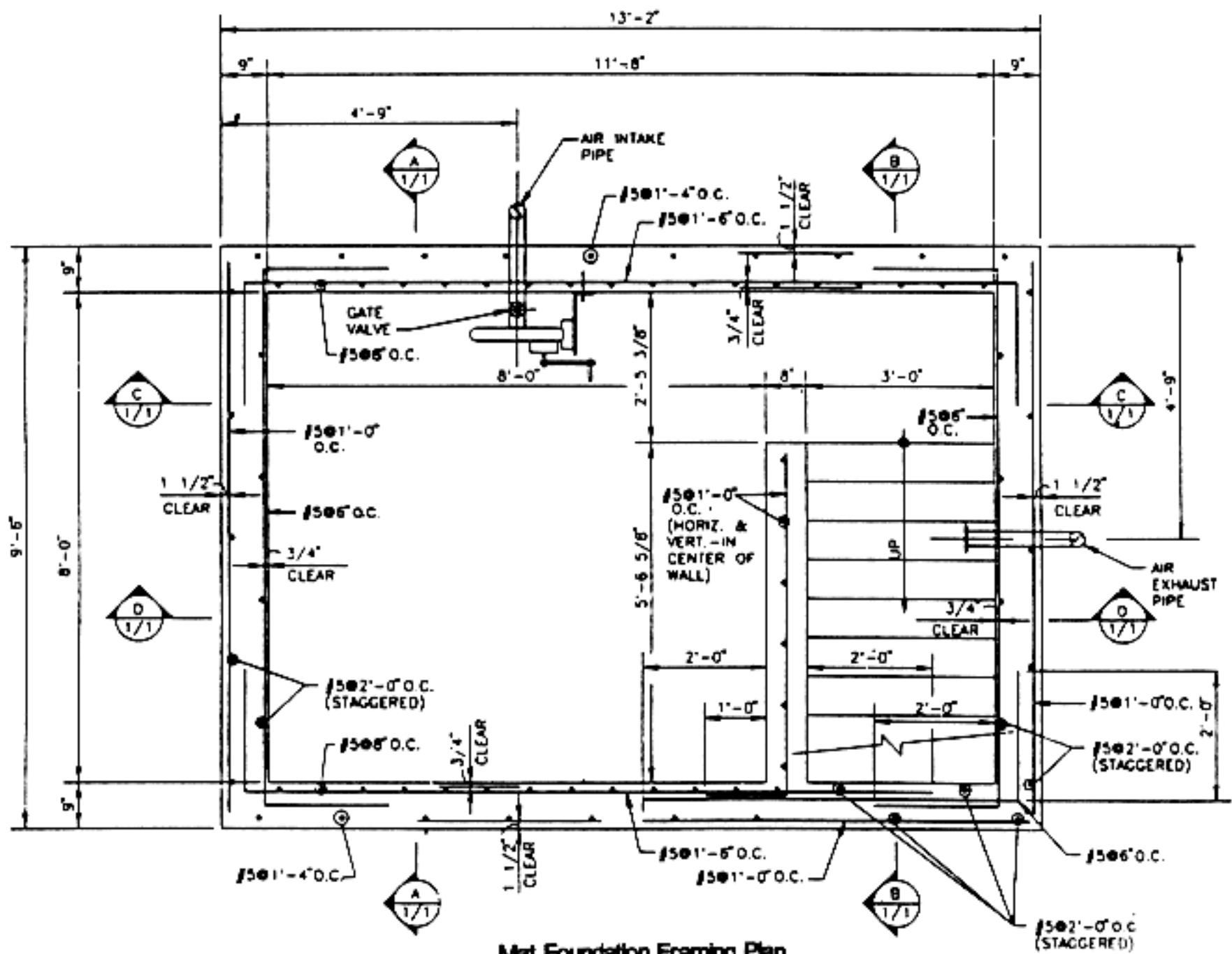

Mat Foundation Framing Plan

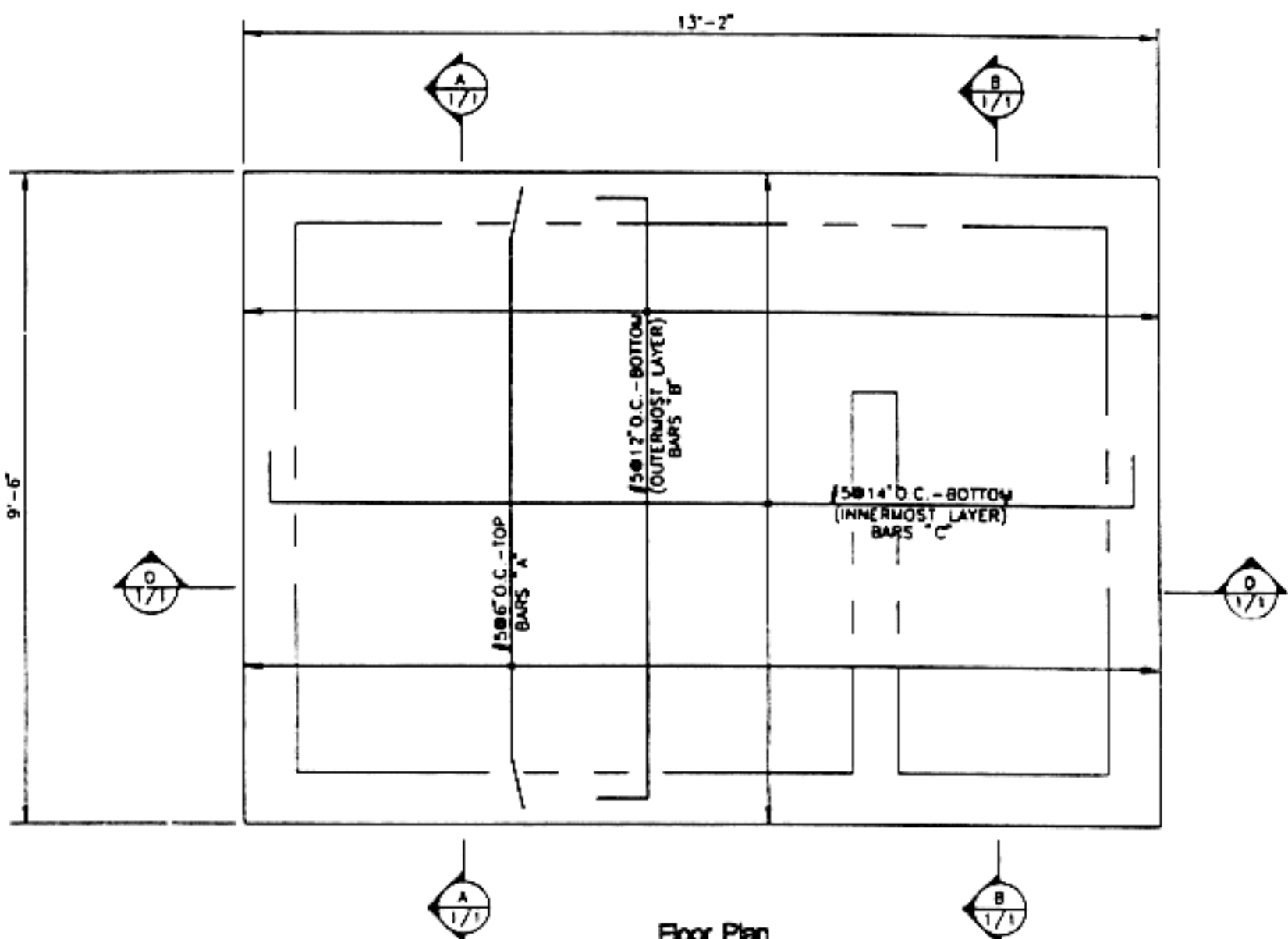

Floor Plan

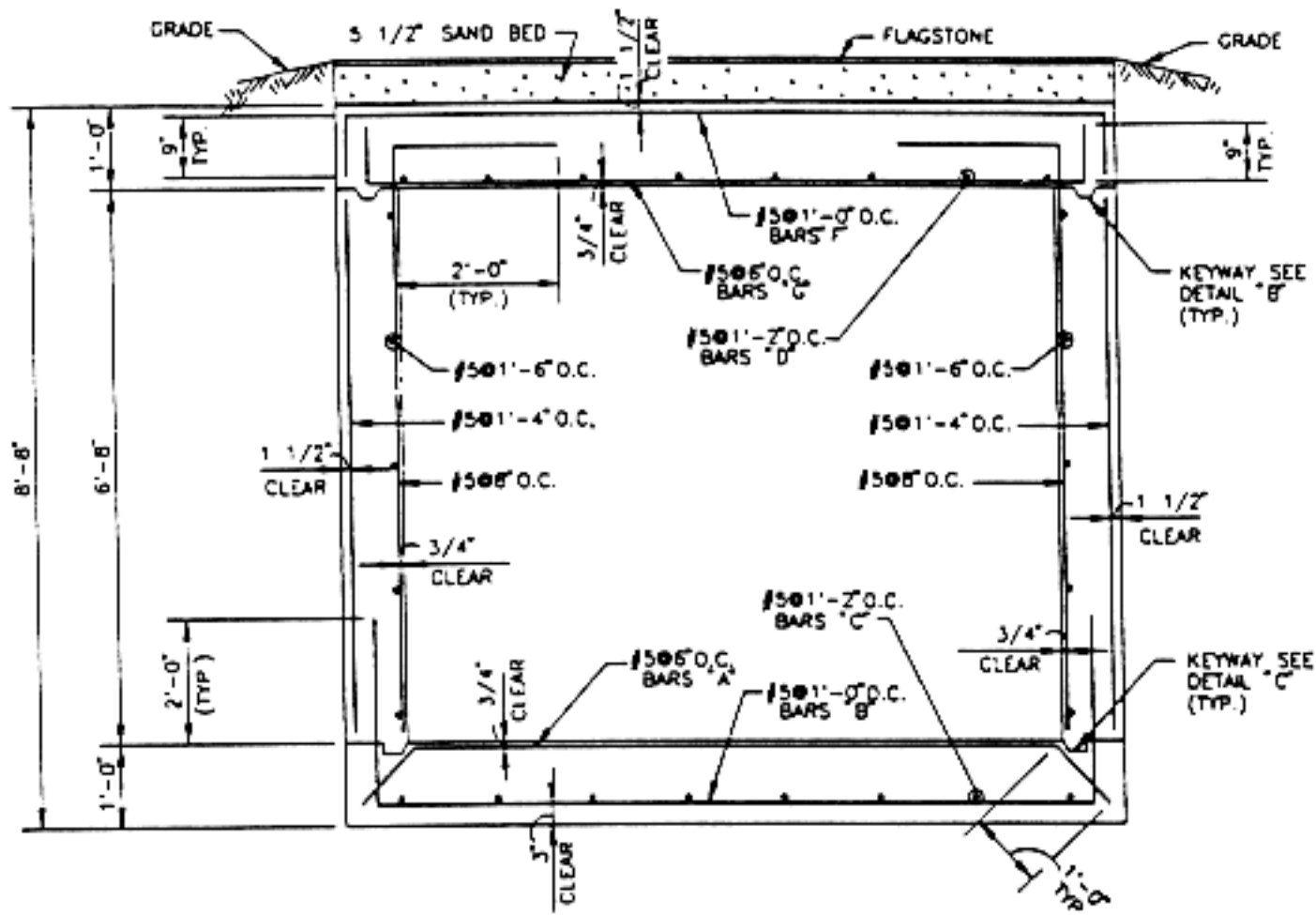

Section A - A

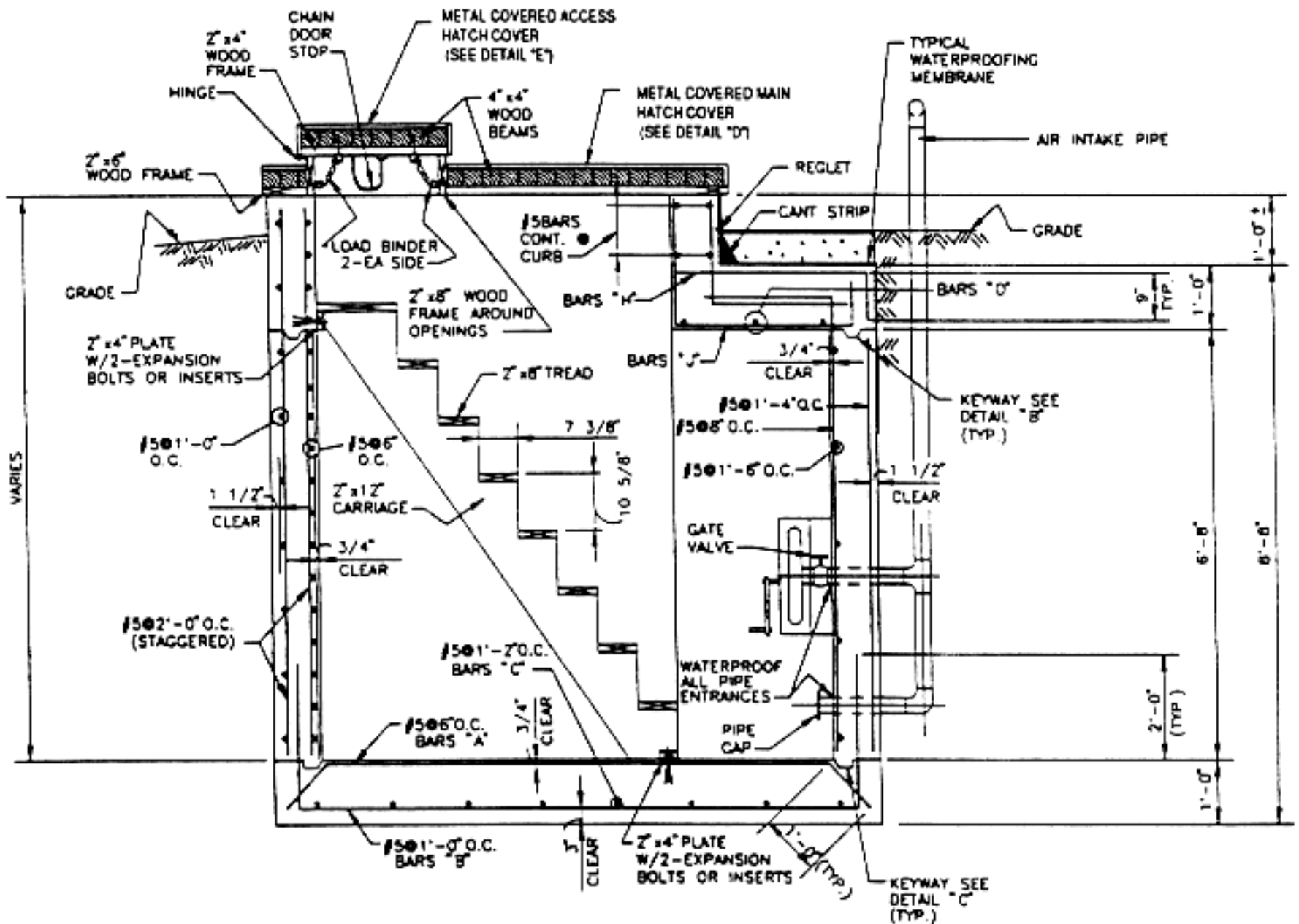

Section B - B

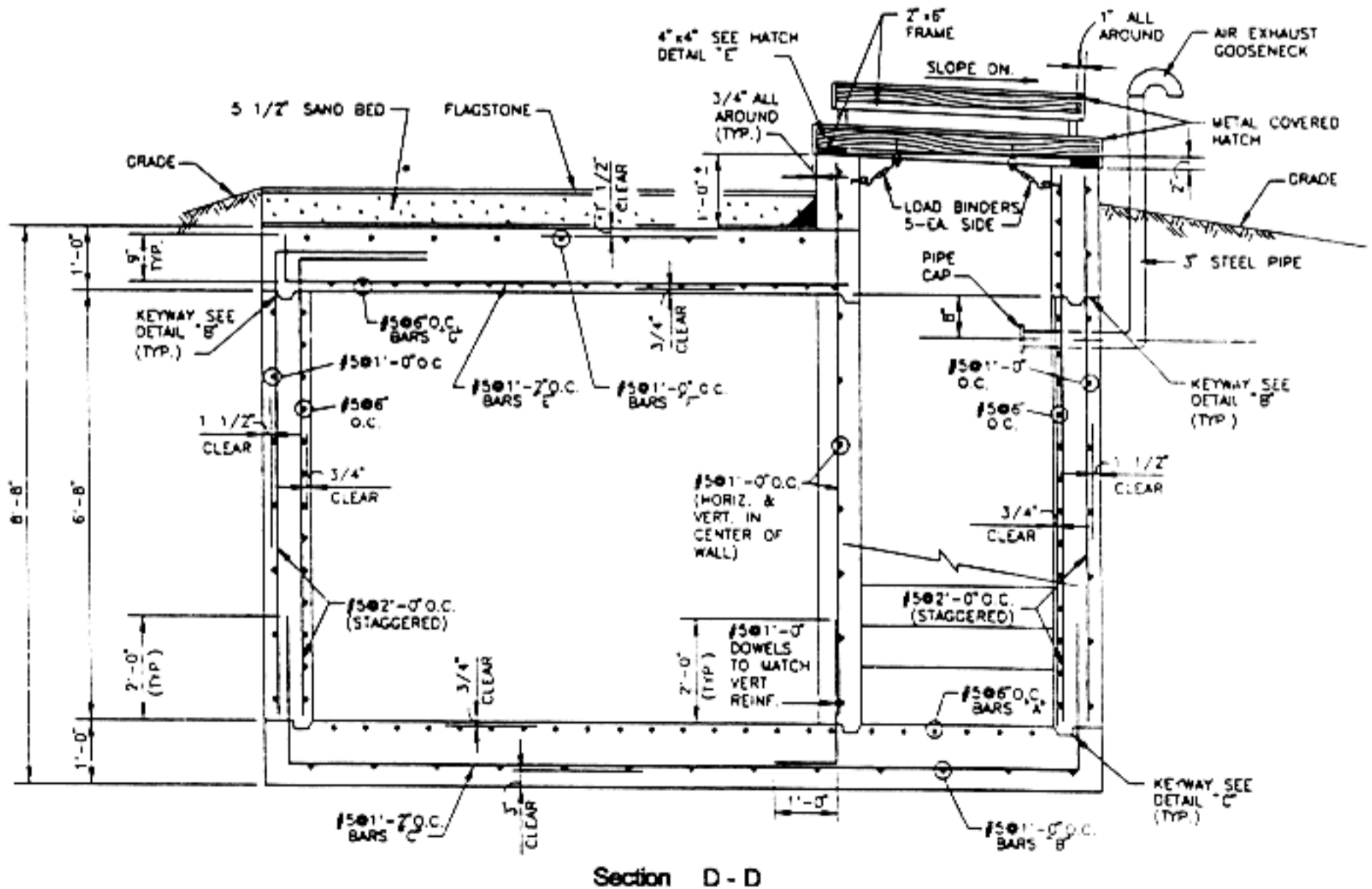
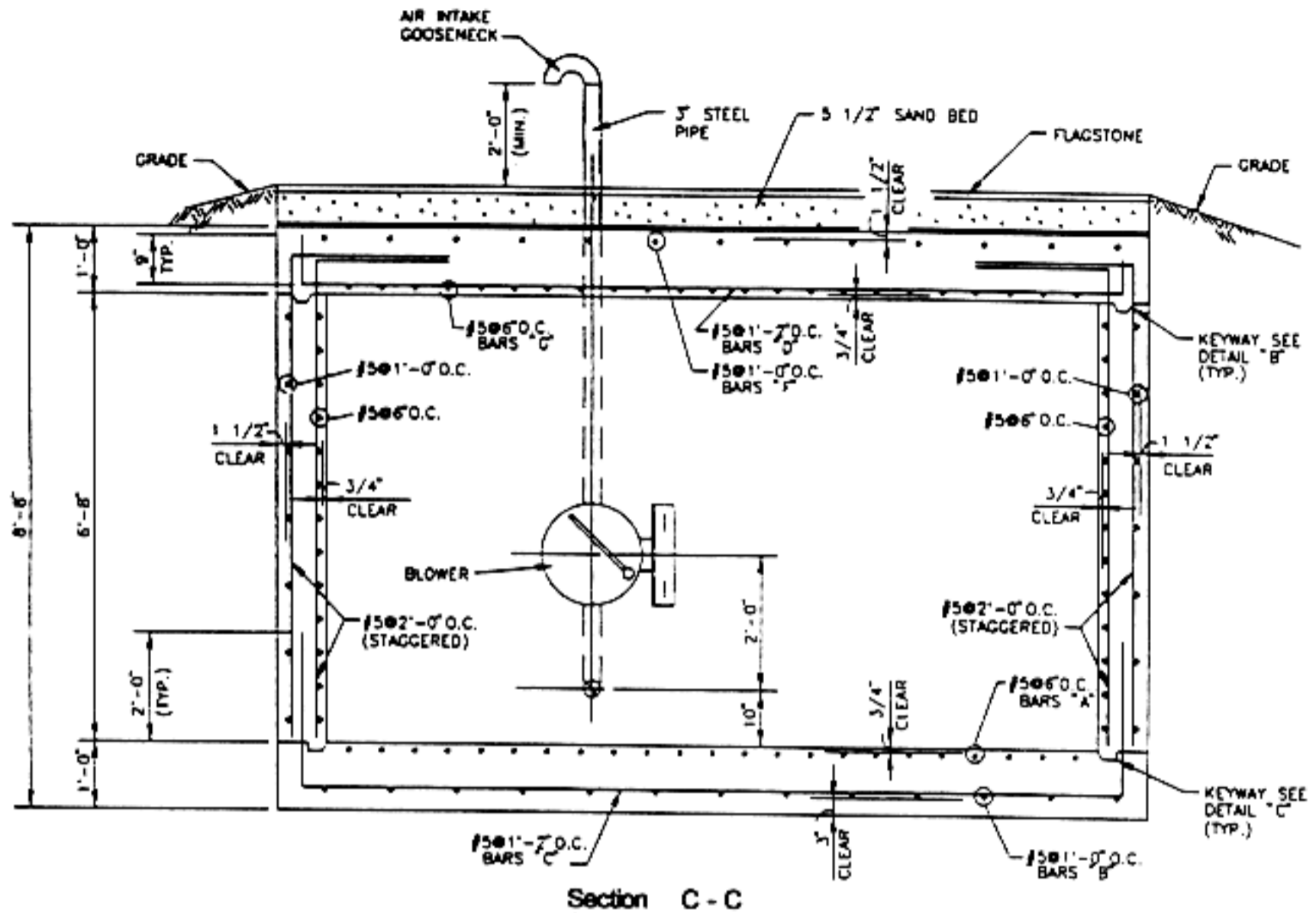

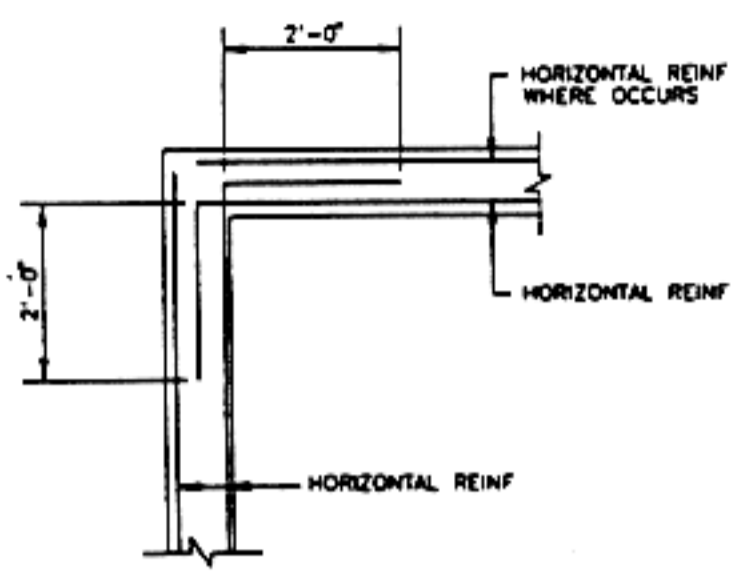

Typical wall reinf at corners

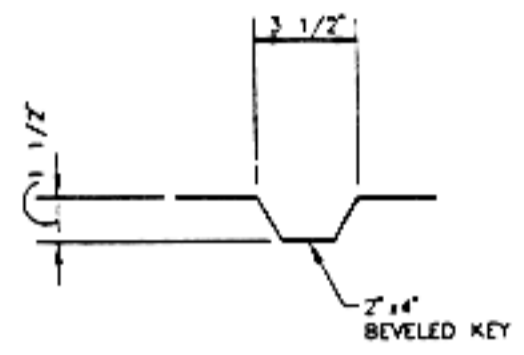

Detail B

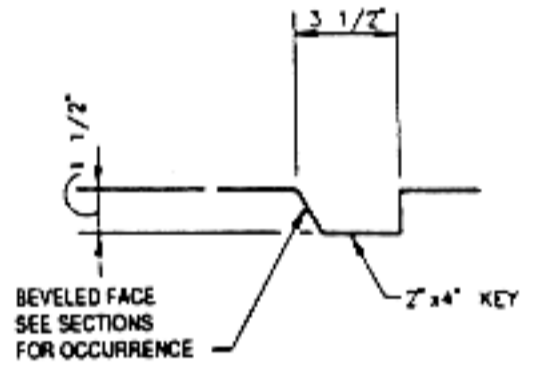

Detail C

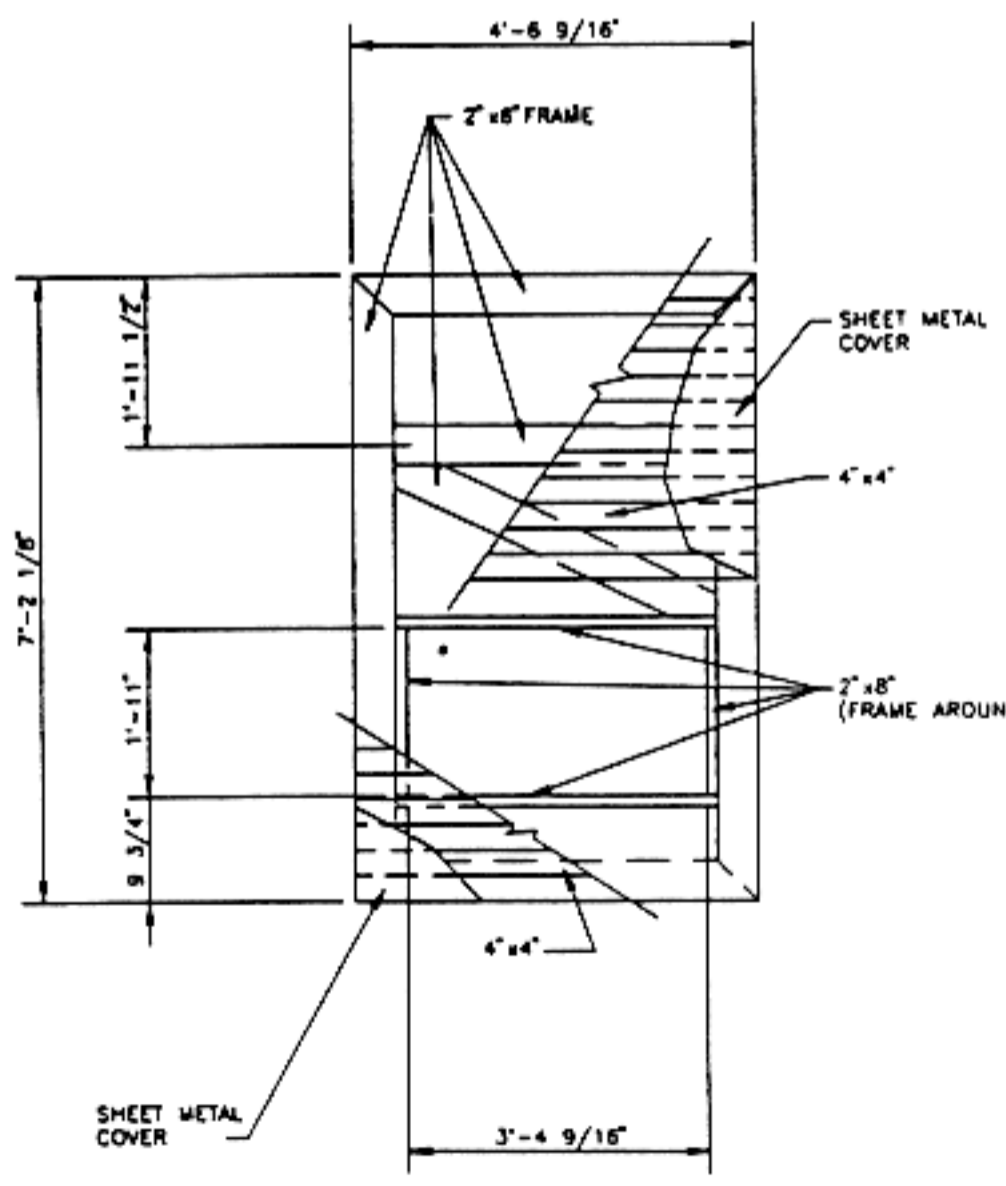

Main Hatch Cover Detail D

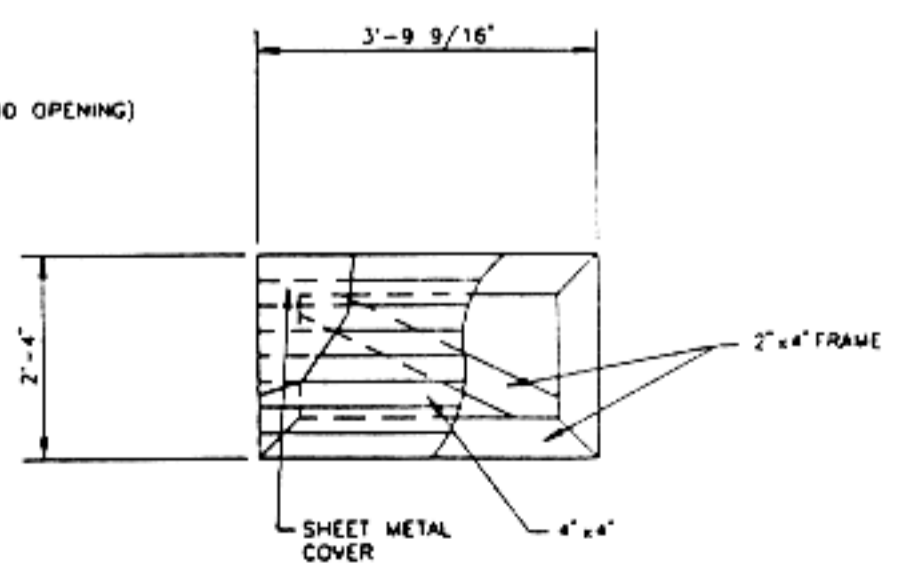

Access Hatch Cover Detail E



**NOTES**

Concrete - All concrete construction shall conform to ACI code 318 - 83. Concrete 28 day strength shall be 3000 psi.

Exposed edges - Bevel all exposed edges of concrete 3 / 4" at 45 degrees.

Reinforcing Steel - All reinforcing steel shall conform to ASTM A 615, Grade 60.

Wood - All wood products shall be fabricated using structural grade lumber with a minimum allowable stress of 500 psi.

Waterproofing - Exterior walls, roof slab, and under the floor slab shall be waterproofed with a continuous membrane waterproofing system.

Hatch Cover - 2" X 4"s (in the hatch) standing on edge may be substituted for the 4" X 4"s. Bolt or screw the 4" X 4" to the frame. Cover the outside with galvanized sheet metal. Provide a smoke tight seal all around the hatch cover (neoprene gasket, weather-stripping, etc.). Load binders and their attachments shall have a capacity of 2000 lbs.

Piping - All pipes, sleeves, and fittings shall be galvanized steel. Openings in air intake and exhaust goosenecks shall be covered with a no. 6 mesh rustproof screen. An optional removable air intake hood can be made and stored in the shelter for use after the blast.

Patio - Place flagstone or bricks on a sand bed when using the roof slab as a patio.

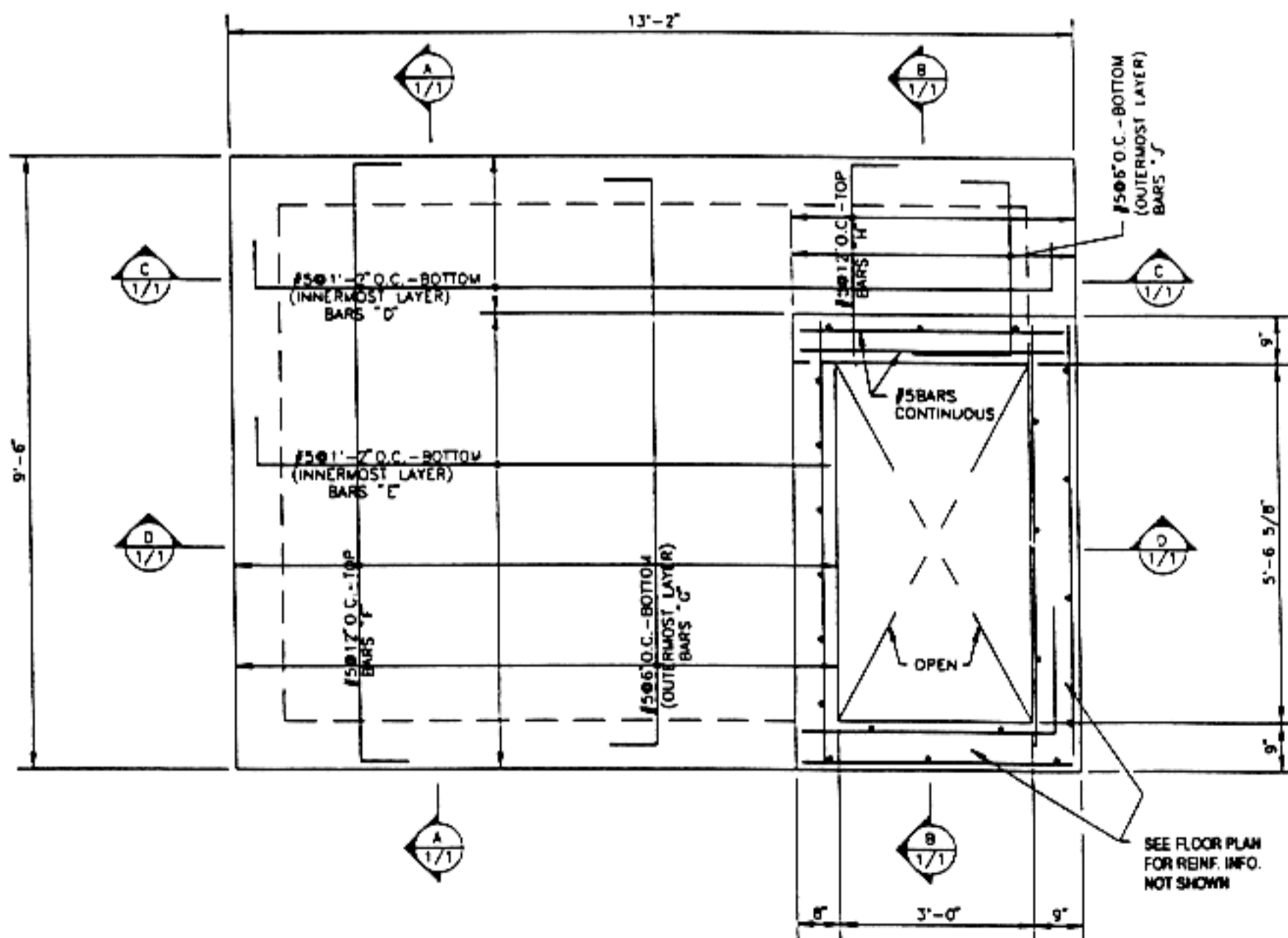

Roof Slab Framing Plan

# LIST OF MATERIALS

<i>ITEM</i>	<i>MATERIAL</i>	<i>GRADE</i>	<i>QUANTITY</i>
<b>CONCRETE</b>			
Reinforcement	Concrete	3,000 psi	18 cu. yds.
	No. 5 Bars	Grade 60	3000 Lin. ft.
<b>HATCHWAY COVER</b>			
Frame, main hatch	2" X 6" lumber	Structural	35 lin. ft.
Frame, access hatch	2" X 4" lumber	Structural	14 lin. ft.
Main beams	4" X 4" lumber	Structural	120 lin. ft.
Access opening frame	2" X 8" lumber	Structural	12 lin. ft.
Metal cover	Sheet Metal	Galvanized	40 sq.ft.
Load binders		2000 lb. cap.	14 pieces
Fasteners to concrete	Exp. Bolt or Insert	2000 lb. cap.	10 pieces
Fasteners to wood		2000 lb. cap.	18 pieces
Access hatch Hinges			2 pieces
Chain door stop			1 pieces
<b>VENTILATION</b>			
blower with bracket			1 unit
Piping	3" Id. Steel	Galvanized	25 lin. ft.
90 degree elbows	3" Id. Steel	Galvanized	2 pieces
Tees	3" Id. Steel	Galvanized	1 pieces
Pipe caps	3" Id. Steel	Galvanized	2 pieces
Gate valve	3" Id. Steel		1 pieces
Goosenecks	3" Id. Steel	Galvanized	2 pieces
Intake hood (optional)			1 unit
<b>STAIRWAY</b>			
Carriage	2" X 12" lumber		24 lin. ft.
Treads	2" X 8" lumber		30 lin. ft.
Plates	2" X 4" lumber		6 lin. ft.
Anchors	Exp. Bolt or Insert		4 pieces
<b>WATERPROOFING</b>			
All exterior surfaces	Membrane		750 sq. ft.
Cant strip			24 lin. ft.
<b>MISCELLANEOUS</b>			
Reinforcing steel supporting accessories, tie wire, etc.			
Nails, screws, and other Fasteners			
Electrical wiring (optional)			
Floor drain and sewer piping (optional)			

# CHAPTER 6

## BASEMENT

### HOME FALLOUT SHELTER

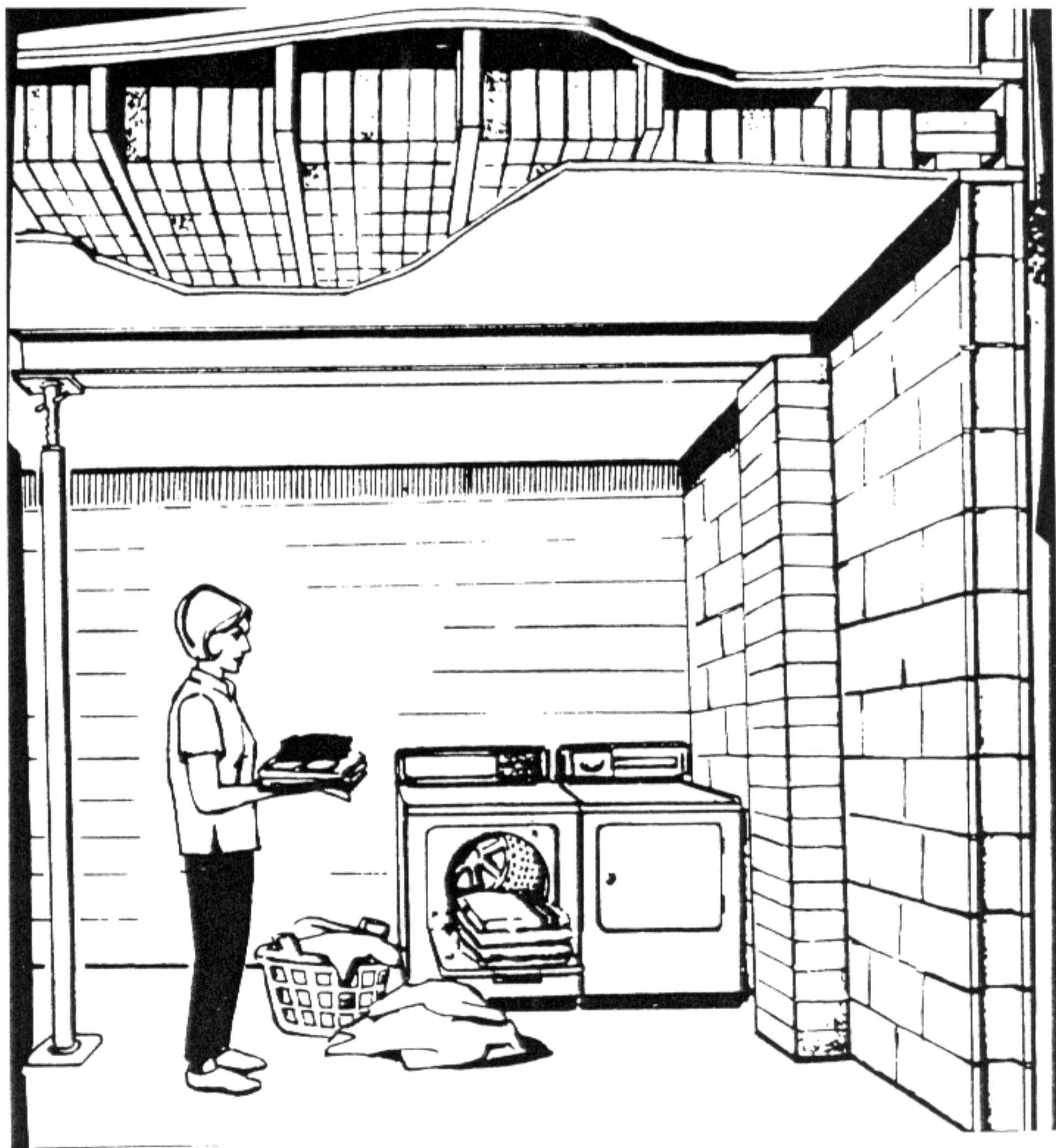

## CAUTION

This home fallout shelter design should only be constructed in low risk areas. A low risk area is one which is not expected to be subject to the blast effects of a nuclear weapon. It is suggested you contact your State or local civil preparedness director for information concerning the type of area you live in, i.e. low risk or high risk area.

## GENERAL INFORMATION

This shelter can be permanently installed in the basement of your home and will not interfere with its utility in any way.

In basements whose walls are mostly below grade on all four sides, adequate shelter from fallout radiation is provided by modifying the overhead floor joist and ceiling construction as shown in the drawings. The plywood, which is screwed to the bottoms of the joist, supports the masonry shielding material and provides a solid base for a more decorative ceiling treatment. A beam and jack post are used to support the extra weight. Approximately 2 man days are required to construct the ceiling.

## SHELTER SIZE

The plans on the preceding pages show two sizes of shelter of this type - a 12' X 16' size, which may be suitable for use in many one story homes, and a 12' X 12' size, which is suitable for use in many two story homes.

On the following pages, under *LIMITATIONS OF THE CEILING MODIFICATION SHELTER IN BASEMENTS*, you will find illustrations of the conditions which make this type of construction an effective shelter, and some additional things that must be done if these conditions are not met by your particular basement situation.

Note that some joist spaces contain heating ducts, or are closed in with sheet metal to serve as return air ducts, the protection in this area of the shelter is reduced since bricks or blocks cannot be placed as shown in the drawings.

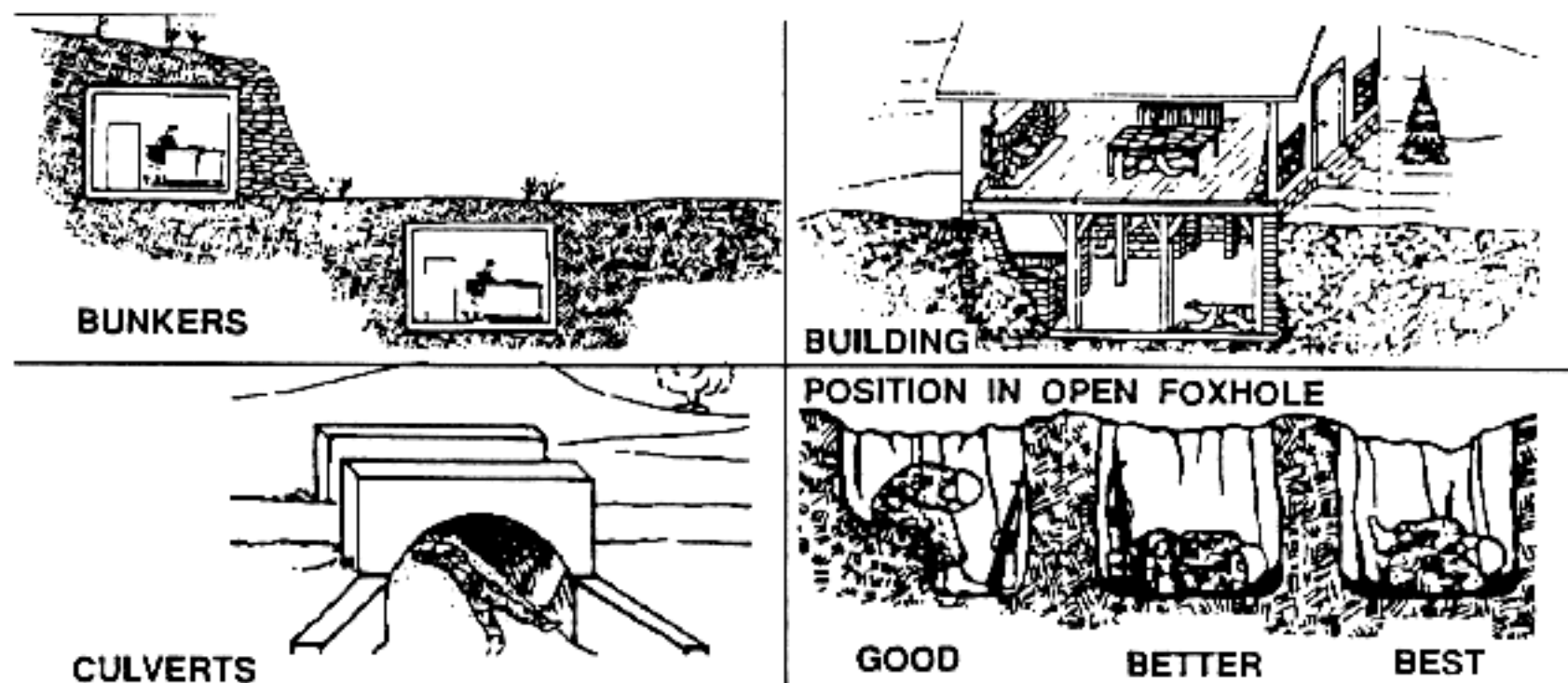

Examples of shelters you should take immediately upon attack



## LIMITS OF THE CEILING MODIFICATION SHELTER IN BASEMENTS

This cross section of a one story house show radiation coming into the basement from fallout particles on the roof and the ground. Most of the radiation comes from the roof because of the shielding effects of the ground outside the basement walls

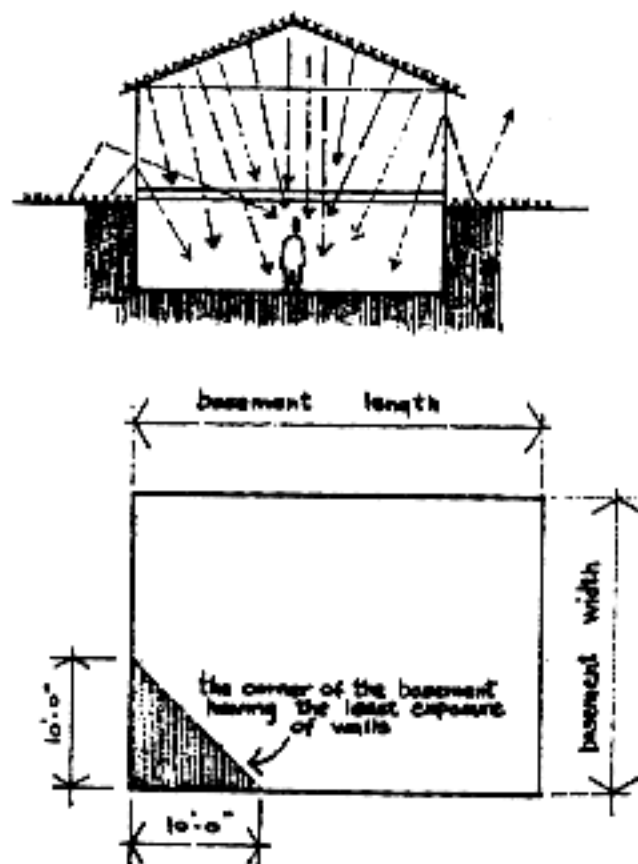

The shaded area in the basement floor plan shows the location of the best potential shelter area (approximately 50 square feet). The drawings of the preceding page are for the adding of bricks or blocks in the ceiling over this best corner.

This placement of added weight in the proper portion of the basement ceiling will considerably improve the protection in the best corner. Note that is not necessary to add this weight of the entire ceiling area.

The extent of the ceiling modification area depends on the type of house (i.e., one or two story), the dimensions of the basement, and the amount of basement wall exposure. In a one story house, approximately one - quarter of the area of the basement ceiling should be filled with the concrete blocks or bricks in order to obtain the most protection out of this improvement.

This arrangement will effectively shield all of the radiation coming from the roof - the largest contributing sources

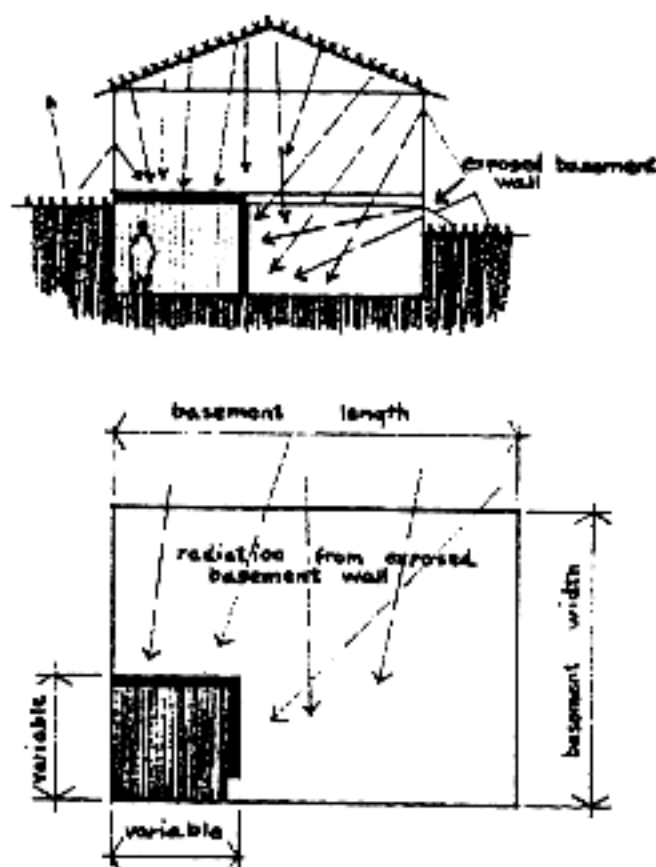
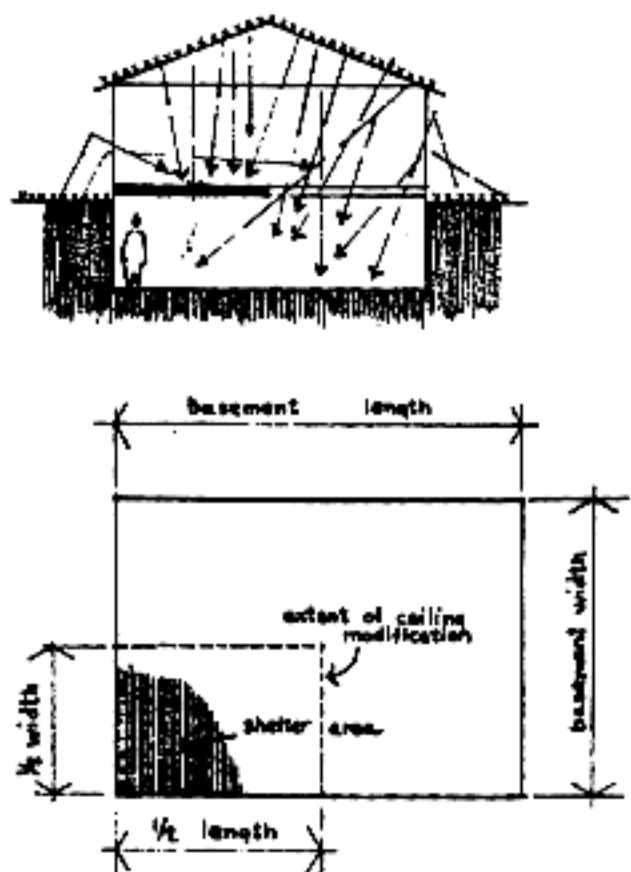

If it is found to be impractical to shield one quarter of the basement ceiling area, the extent of ceiling modifications may be reduced to any desired size by constructing vertical masonry walls on the two open sides of the shielding area, thus providing a room suitable for use as a hobby or laundry room. These masonry walls will also provide protection from excessive amount of radiation coming through exposed portions of the basement wall.

In homes with 2 or more stories above ground, the extent of the basement ceiling modification can usually be reduced to 12' X 12'. Note, however, that vertical side walls may be required if the basement wall exposure exceeds two feet.

Adding bricks or blocks to the basement ceiling can also create shelter in certain portions of the basement of split level homes. It is recommended that expert advice be sought for basement situations which do not fit the plan sizes or illustrations in this manual.

## **MEDICAL SIGNS OF RADIATION SICKNESS**

**INITIAL SYMPTOMS** - Low doses of radiation are not life threatening and will produce limited ineffectiveness and usually for only brief periods, most people should be able to perform limited work and buddy aid between these attacks and during the long latent period. For doses greater than 500 cGy the initial symptoms can be quite severe and, though disabling, do not immediately threaten life.

**REDUCED RESISTANCE TO INJURY AND DISEASE** - As radiation injury is increased, general health deteriorates and the damaged immune system loses its ability to protect the body. Radiation injury and the harsh sheltered environment work in combination to produce a reduced state of health in the person. This weakened condition leads to a significant increase in the numbers of disease and infection casualties. Radiation injury makes people more susceptible to the effects of chemical and biological agents.

**DELAYED HEALING AND MEDICAL COMPLICATIONS** - People injured after severe radiation exposure will face increased mortality and a lengthened course of recovery. If the injury to the immune system has been severe, patients probably will not be able to resist infection. After radiation exposure, wound healing will be delayed and the duration of medical treatment and mortality will be increased compared to a similar wound without radiation exposure. Severely exposed persons should be assigned work that minimizes the risk of further injury until the immune system has recovered.

## **COMBINED INJURY RADIATION AND WOUNDS**

The initial radiation injury is not an immediate medical emergency in combined injury. Initial medical treatment is directed toward preserving life and limb.

**PROLONGED AND MORE COMPLEX TREATMENT** - Healing of wounds will take longer, as there is actually a delay of the healing process. Additionally, radiation injury can change the effects of medical drugs and complicate medical diagnosis.

**SURGERY AND COMPLETE EARLY TREATMENT** - To minimize the complications of infections on both the healing process and patient survival, every attempt will be made to complete surgical procedures before the immune system is depressed.

**INCREASED MORTALITY** - Even moderate injuries can lower the LD-50 substantially. Stated another way, radiation exposures will increase mortality rates over that expected for just the conventional injury. Conventional injuries combined with radiation exposure are very serious, and prompt medical diagnosis and treatment should not be delayed. Injuries that are benign by themselves may become lethal when combined with relatively small doses of whole body radiation exposure.

Complete coverage should be achieved. As seen in the accompanying picture the varied elements of radioactive emissions are erratic and will penetrate low density walls, roofing and floors easily. **Anything** you can do to reduce your exposure level and exposure time could extend your life.

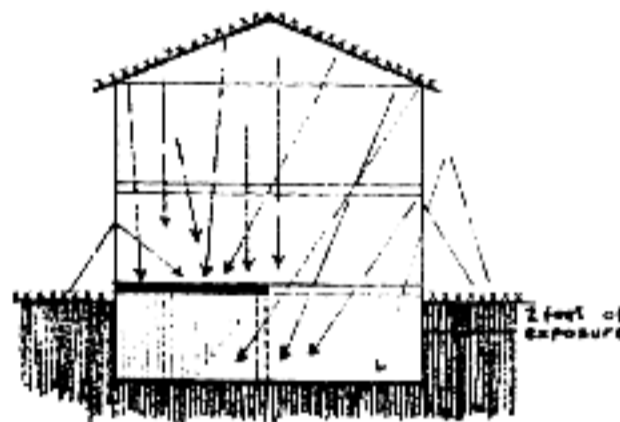

## **CONSTRUCTION SEQUENCE**

1. Drill holes in block wall for lead insert shields and attach corrugated ties with screws, two per mortar joint.
2. Lay up 8" X 8" masonry pier against wall, tying pier to wall with corrugated ties.
3. Locate and drill for machine bolt anchors in basement floor using base plate of jack post for templet.
4. Thoroughly coat under side of foundation plate with rust inhibiting paint.
5. Place foundation plate and base plate of jack post over anchors and drive anchors bolts tight.
6. Lower jack and bolt one end of steel beam to top plate, resting other end temporarily on top of pier.
7. Raise jack to level position of beam, shimming under pier end to a snug fit under the joist.

**PRECAUTIONARY NOTE;** Excessive tightening of the jack post at this point may cause undue stress in the joists and slab, as the ceiling spaces are filled, Make several adjustments in the post as the material is added.

8. Grout mortar under beam at pier.
9. Cut plywood into 2' X 8' sheets.
10. Starting at wall, attach plywood to joist bottoms, using 2" #8 screws.
11. Remove cross bridging, if any, from existing joist spaces.
12. Fill the joist spaces with blocks or brick.
13. Repeat steps 10, 11, and 12 for each of the other sheets.

Before constructing the shelter described here, you should check to see that the construction conforms to your local building codes, and whether a building permit is required.

If work is to be done by a builder or contractor, it is recommended that firms be retained that carry necessary insurance and guarantees to properly protect the owner against subsequent liability and claims on the work and to insure satisfactory results. Members of the National Association of Home Builders and the Associated General Contractors meet these requirements of protection for the home owner.



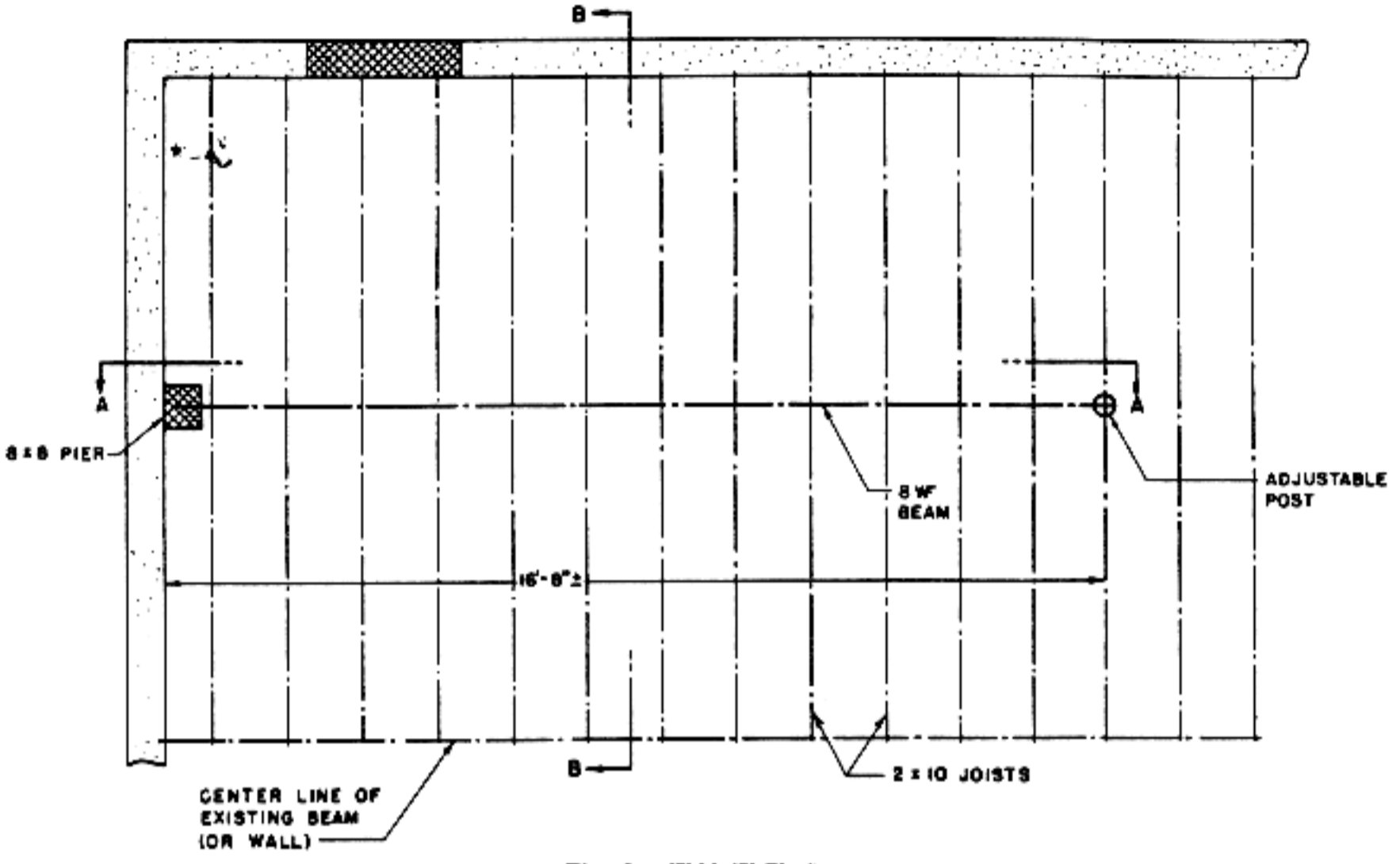

Plan for 12 X 16 Shelter

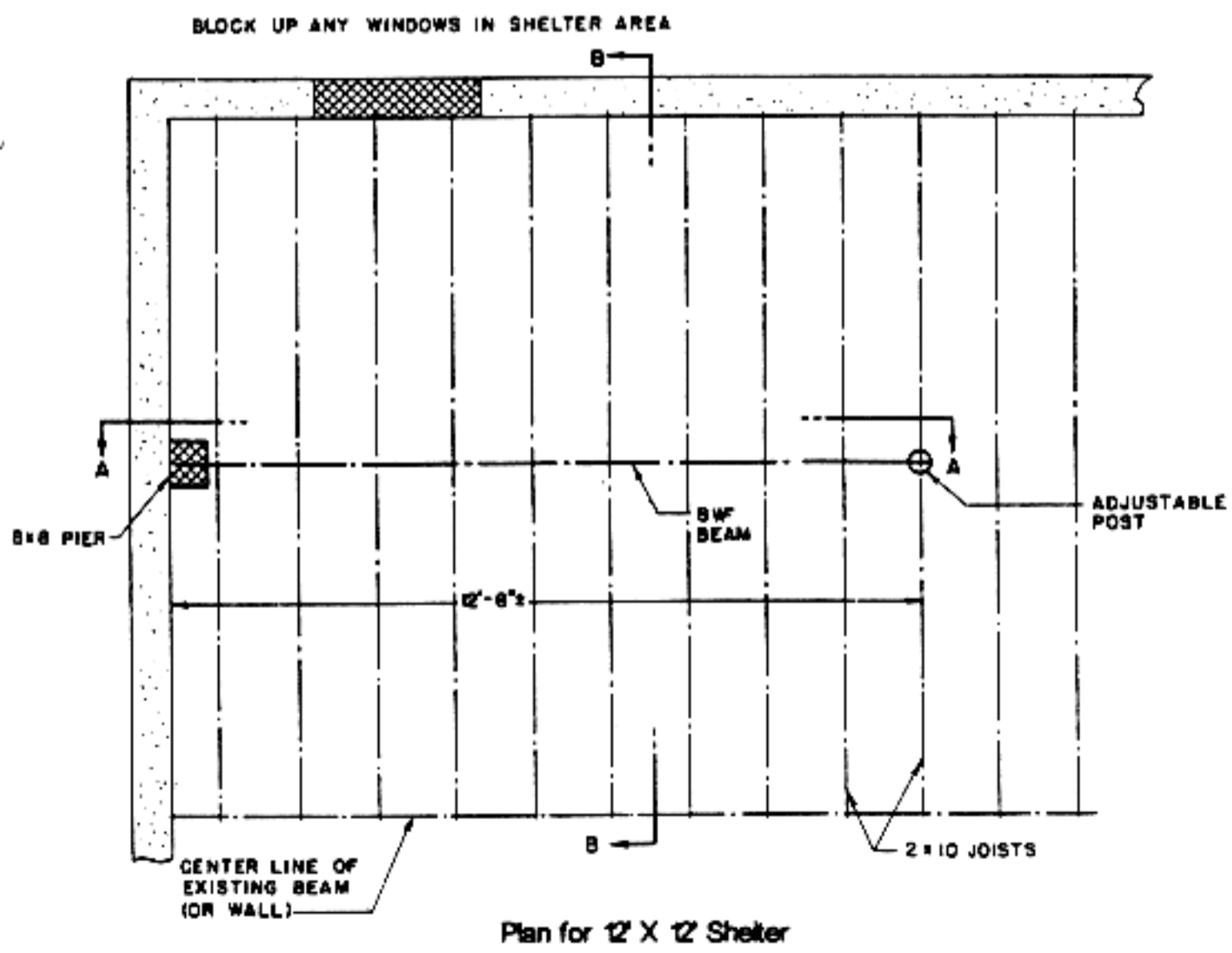

Plan for 12 X 12 Shelter



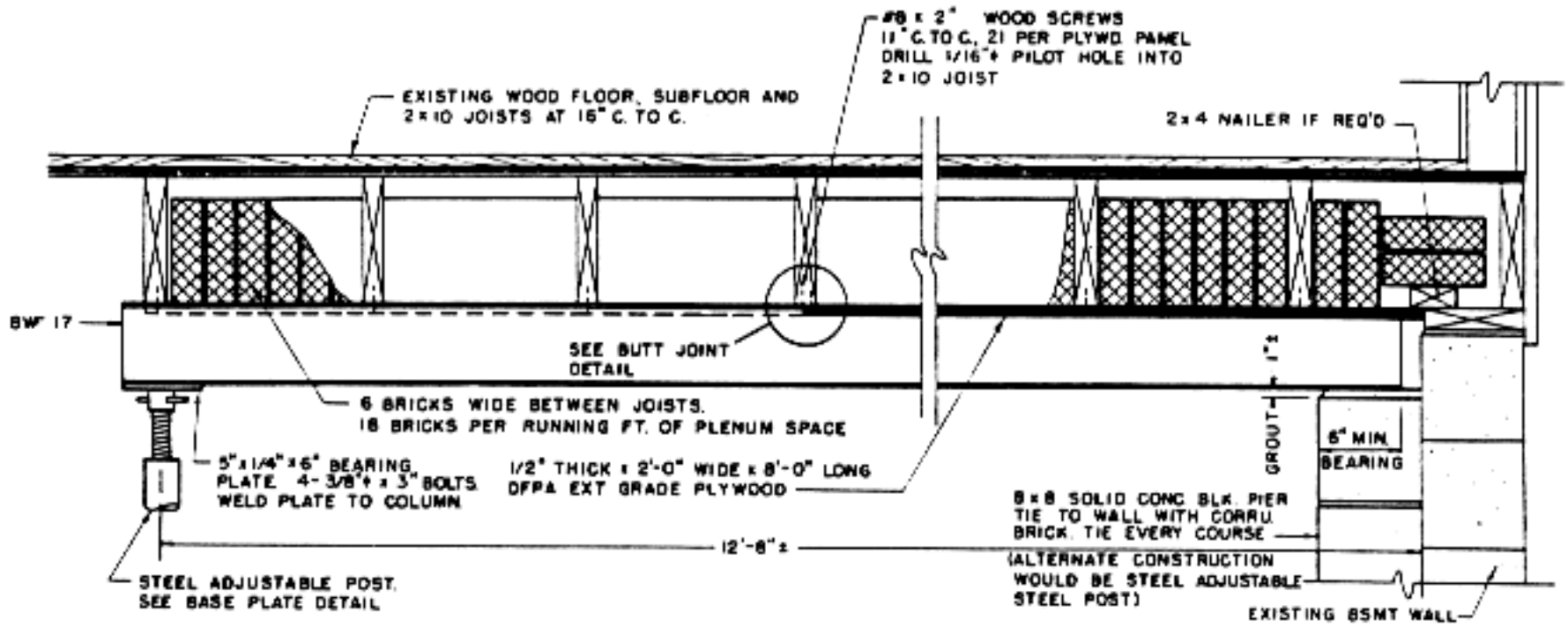

Section A

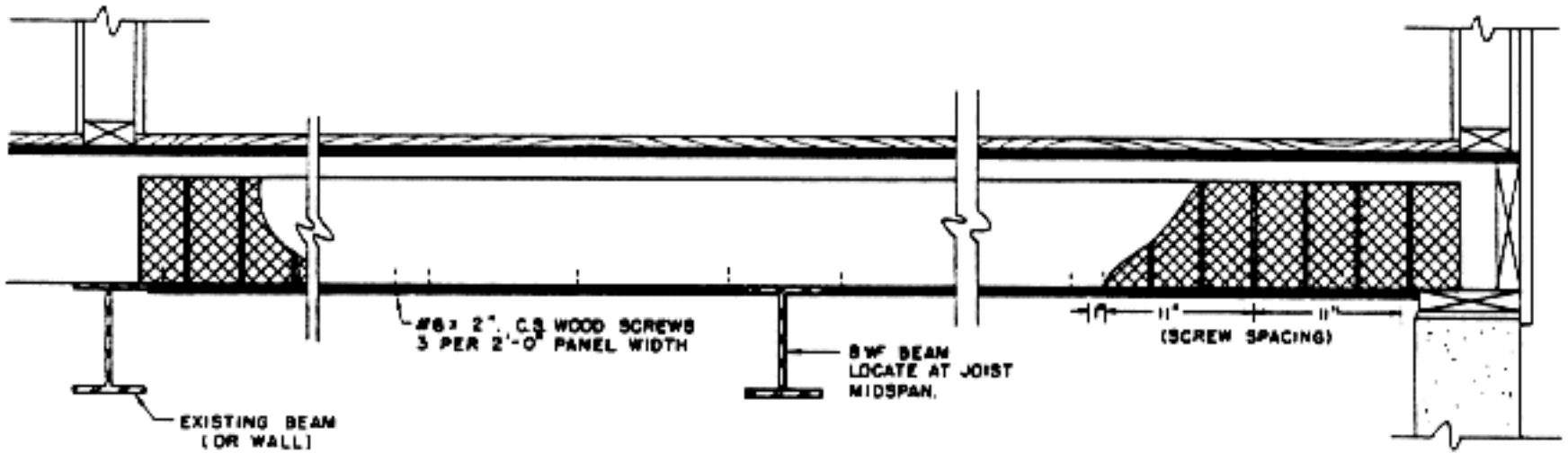

Section B

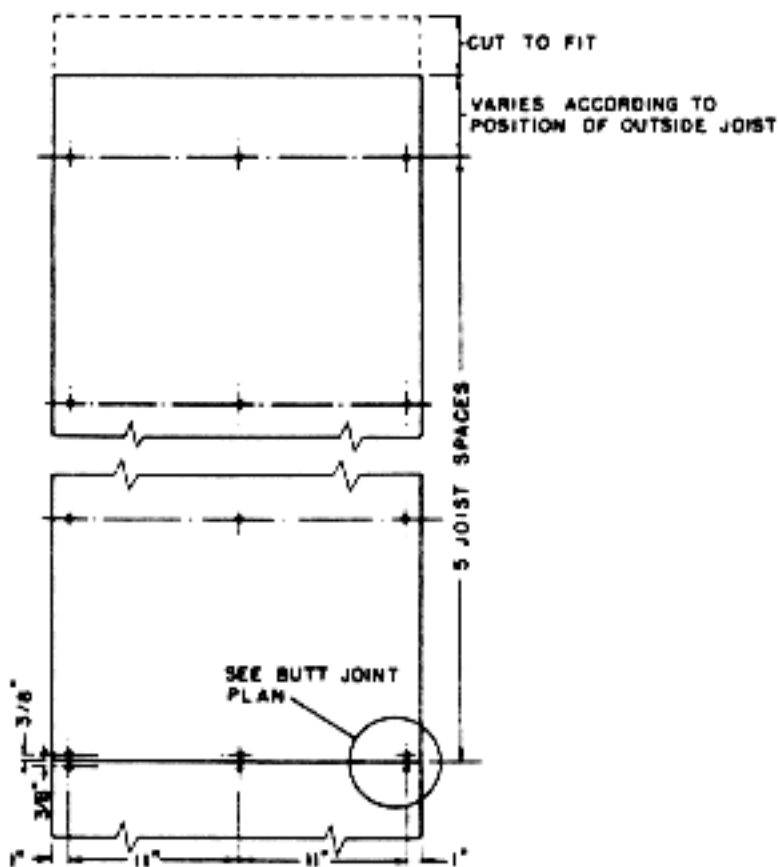

Plan of typical plywood ceiling panel

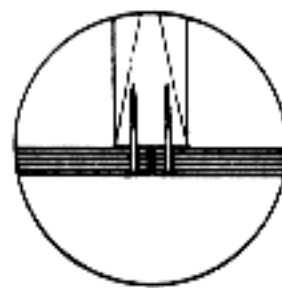

Butt joint detail

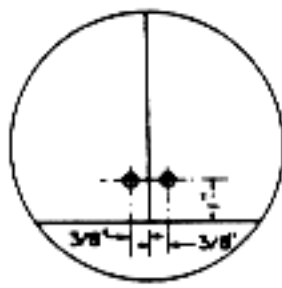

Butt joint plan

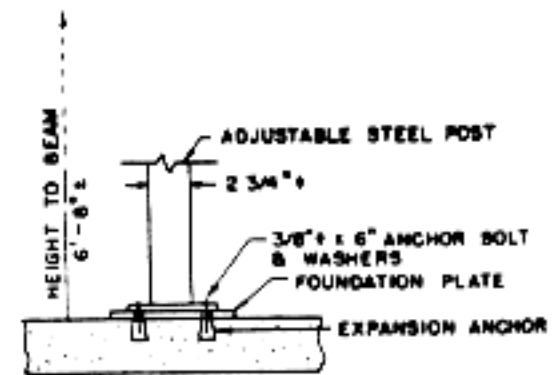
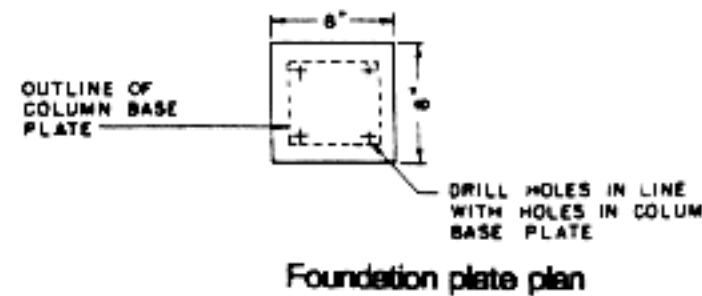

Base plate detail

# MATERIALS LIST

<i>ITEM</i>	12' x 16' SIZE	12' x 12' SIZE
<b>MASONRY</b>		
4" X 8" X 16" solid concrete blocks or	432 blocks or	330 blocks or
2 - 1 / 4" X 4" X 8" bricks	2492 bricks	1978 bricks
8" X 8" X 8" solid concrete blocks		
(standard stone aggregate no - sand forming)	10	10
<b>MORTAR</b>		
prepared dry - mix bags	1 bag	1 bag
<b>PLYWOOD SHEETS; (cut to fit exact basement dimesions)</b>		
1 / 2" 5 - ply Utility B - C grade, good one side.		
7' - 0" X 8' - 0" sections	12	6
2' - 0" X 4' - 0"		6
<b>STEEL</b>		
8WF17 beam (determine length of basement dimensions). Maximum span 16' - 0"		
Adjustable steel posts with tubes 13 ga., top tube 2 - 1 / 2", bottom tube 2 - 3 / 4" with 5" X 6" X 1 / 4" plate welded to each end.	1	1
8" X 8" X 3 / 8" extra base plate, 4 - 7 / 16" holes in each plate	1	1
<b>HARDWARE</b>		
3 / 8" sq. head unfinished bolts each with 2 washers and nuts.	4	4
3 / 8" X 6" sq. head unfinished bolts each with 1 washer and nuts	4	4
3 / 8" size multiple expanding machine bolts anchors hole size is 3 / 4" X 2 - 7 / 8"		
Corrugated brick ties, galvanized steel 23 ga., 7 / 8 X 7"	16	16
#5 screw gage size letter insert shields, hole size 1 / 4" X 1 - 1 / 2"	16	16
#5 X 1 - 1 / 2" unfinished wood screws	16	16
#8 X 2" cad. plated wood screws, c.s.	260	195

The materials list shows quantities for the two plan sizes shown. If additional materials are required for the building of shielding walls in an emergency, they must be added to the list.

## SPECIAL TOOLS;

1 / 4" and 3 / 4" star drills to install anchoring devices

\*Greater depth will be required for longer then specified spans of the I beam

# CHAPTER 7

## BASEMENT

### HOME FALLOUT SHELTER

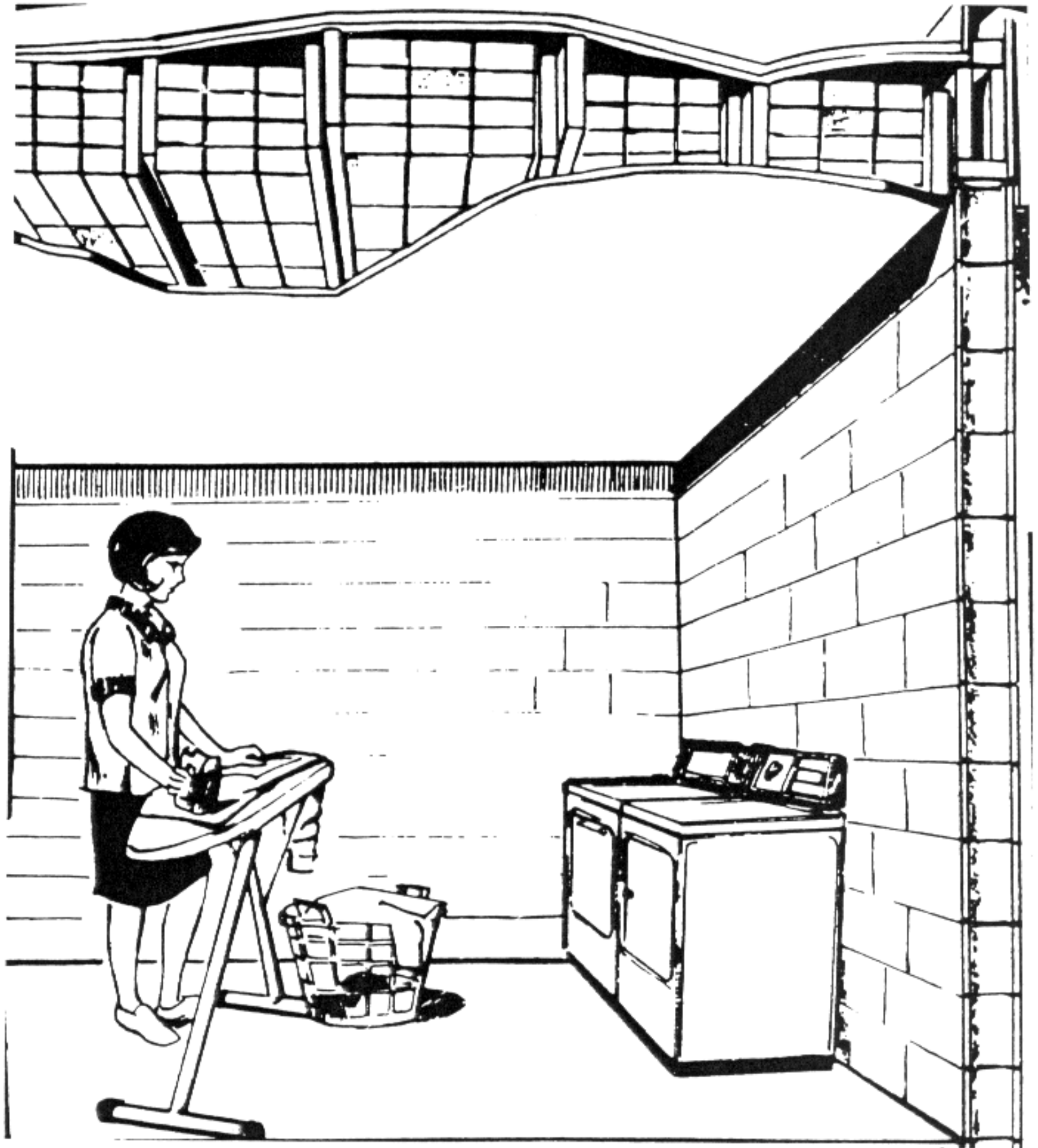

## GENERAL INFORMATION

This shelter can be permanently installed in the basement of your home and will not interfere with its utility in any way.

In basements whose walls are mostly below grade on all four sides, adequate shelter from fallout radiation is provided by modifying the overhead 2 X 10 floor joist and ceiling construction as shown in the drawings. New 2 X 12 joists, notched to the depth of the existing 2 X 10's, are installed along side these joists in order to carry the extra weight of the shielding material. Plywood, screwed to the 2 X 12 bottoms, supports the masonry and provides a solid base for a more decorative ceiling treatment. Approximately 2 man days are required to construct the ceiling.

## SHELTER SIZE

The plans on the preceding pages show two sizes of shelters of this type - a 12' X 16' size, which may be suitable for use in many one story homes and a 12' X 12' size, which is suitable for use in many two story homes.

On the following pages, under limitations of the ceiling modifications shelter in basements, you will find illustrations of the condition which made this type of construction an effective shelter, and some additional things that must be done if these conditions are not met by your particular basement situation.

Note; that if some joist spaces contain heating ducts, or are closed in with sheet metal to serve as return air ducts, the protection in these areas of the shelter is reduced since bricks or blocks cannot be placed as shown in the drawings. As with the first example beginning on page 78 the radiation shielding will be similar. If the addition of walls is desired (recommended by us) then the extra materials will be needed to be added to the materials list.

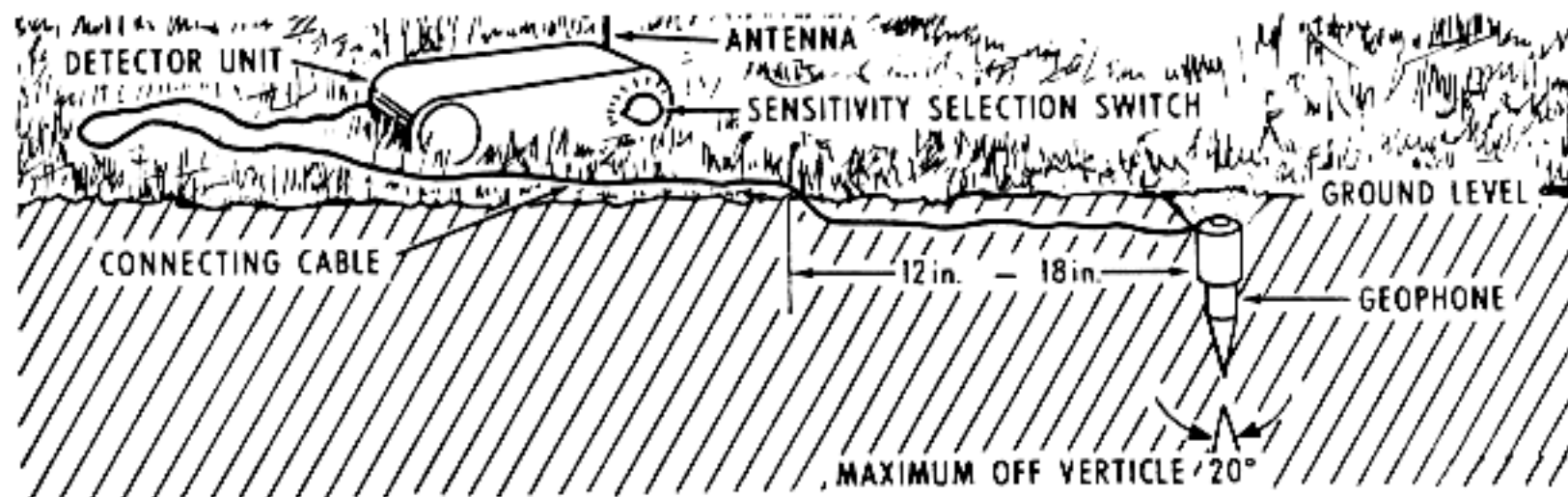

### ANTI - INTRUSION ALARM SET

used to track and locate surface and subsurface noise



---

## **CONSTRUCTION SEQUENCE**

1. Cut 2 X 12's to length required for bearing on both ends (see drawing).
2. Cut end notches in 2 X 12's as shown in drawings. Be sure to ease the notch at 45 degrees or less angle as shown. Be careful not to saw further than the 2" notch depth required.
3. Starting at the wall, remove the cross bridging from 6 joist spaces and insert the 2 X 12's into the places over the center beam or wall, shaving the joist as far as is needed to allow raising the end at the outside wall for seatings on the plate.
4. Measuring the width of the spaces left and cut the center and end blocking.
4. Install the center and end blocking, aligning as shown in the details.
6. Reinstall one (shortened) piece of cross bridging under the center blocking.
7. Starting at the wall, attach one 1 / 2" plywood panel to the 2 X 12's, using the two inch #8 screws as shown in the plan.
8. Fill the joist spaces above the plywood with bricks or a combination of blocks and bricks to provide as much weight as possible in the depth of the 2 X 12's, which is the intention of the drawings 9. (Repeat steps 7 and 8 for the entire width of the shelter).
10. Repeat steps 3 through 9 for the balance of the length of the shelter.

Before constructing the shelter described here, you should check to see that the construction conforms to your local building codes, and whether a building permit is required.

If work is to be done by a builder or contractor, it is recommended that firms be retained that carry necessary insurance and guarantees to properly protect the owner against subsequent liability and claims on the work and to insure satisfactory results. Members of the National Association of Home Builders and the Associated General Contractors meet these and other requirements for protection of the homeowner.

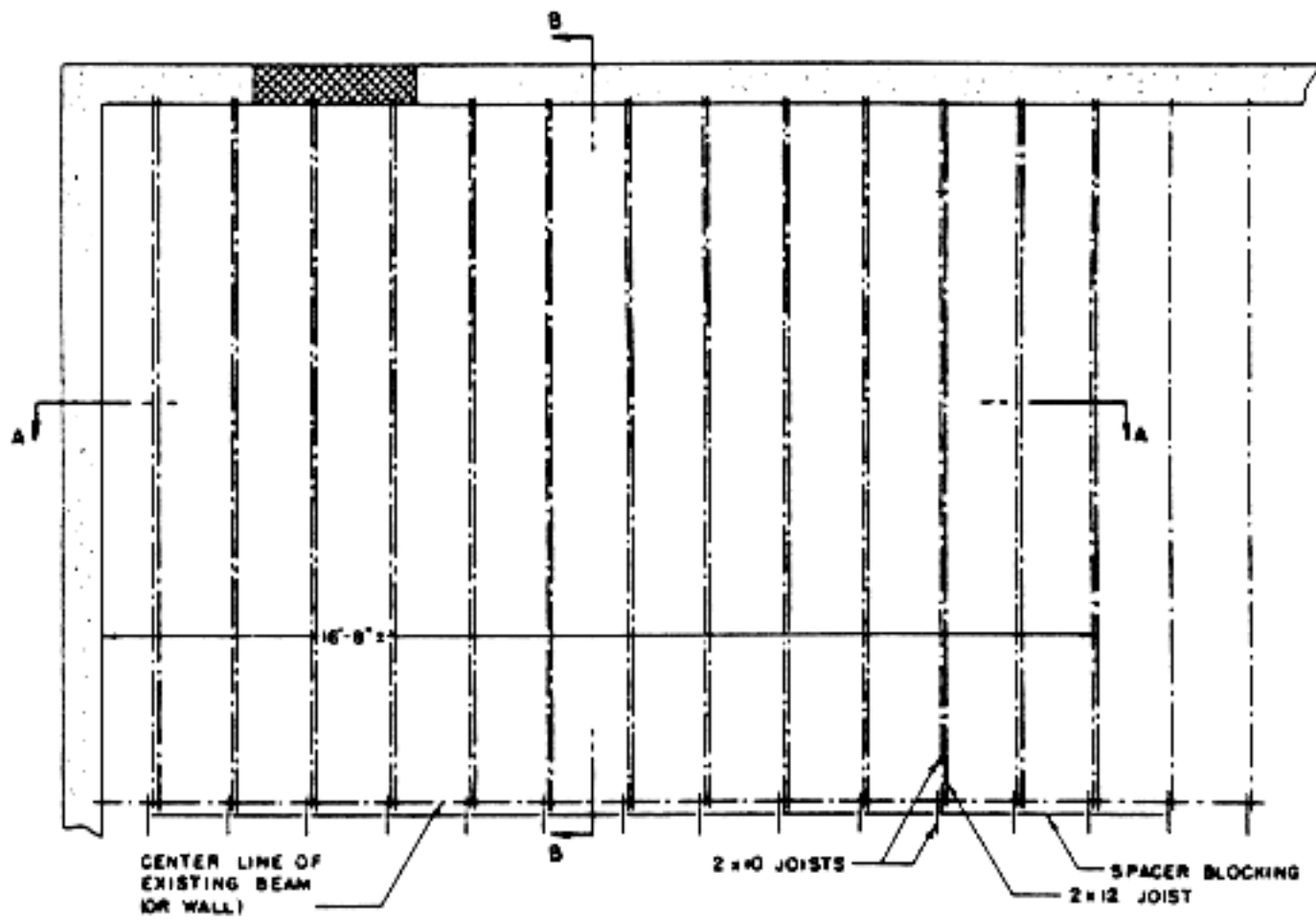

Plan for 12 X 16 Shelter

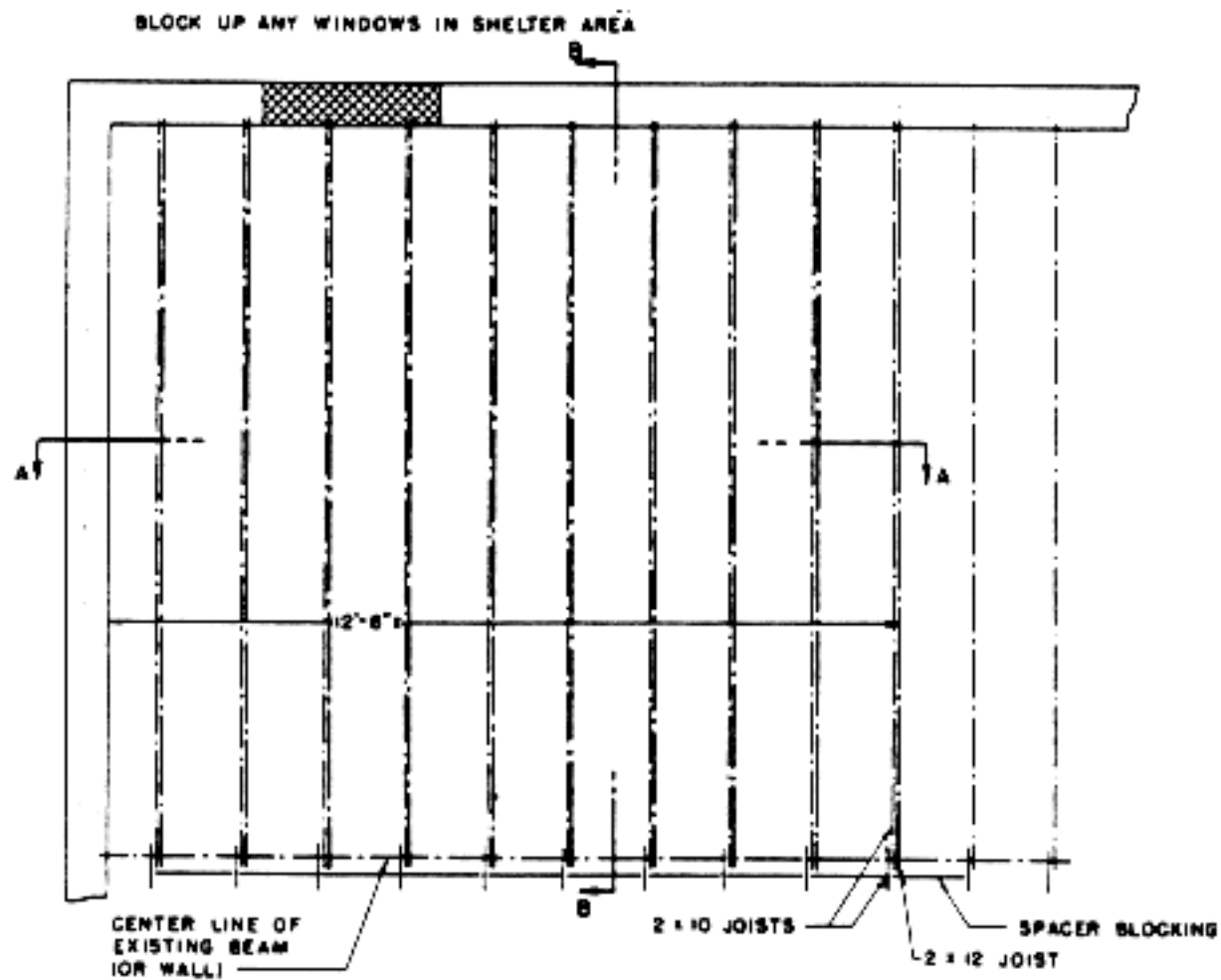

Plan for 12 X 12 Shelter

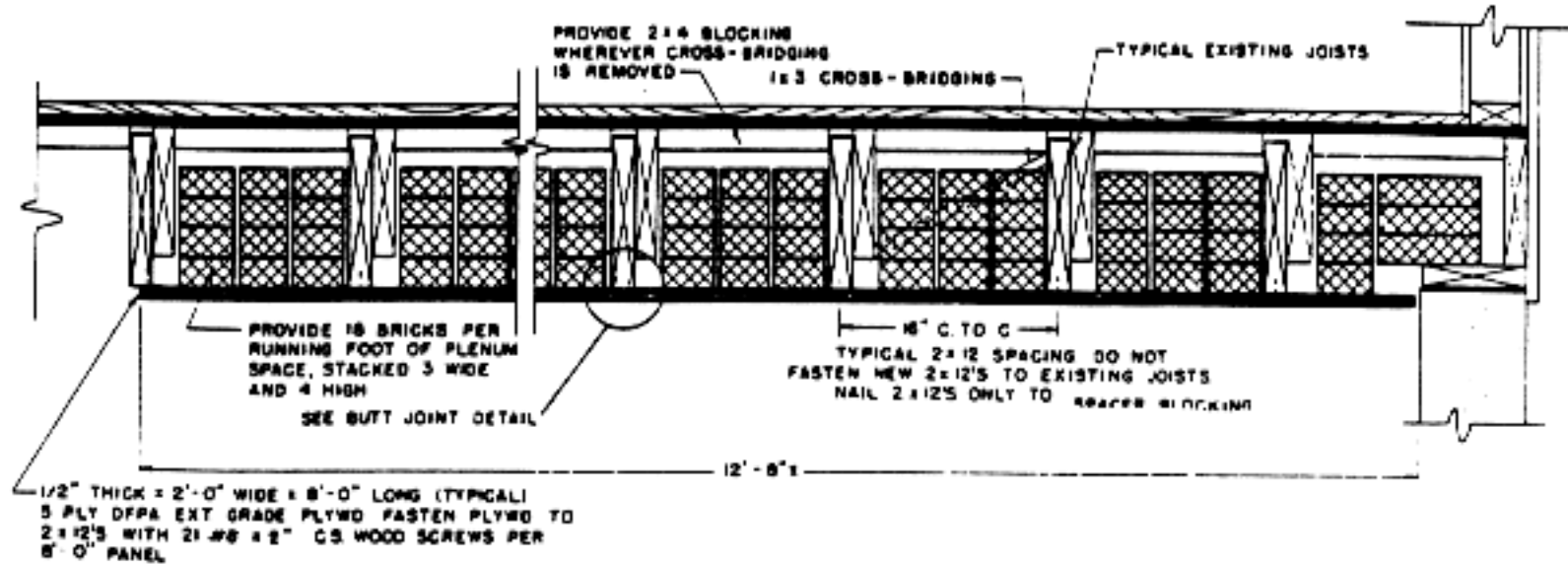

Section A

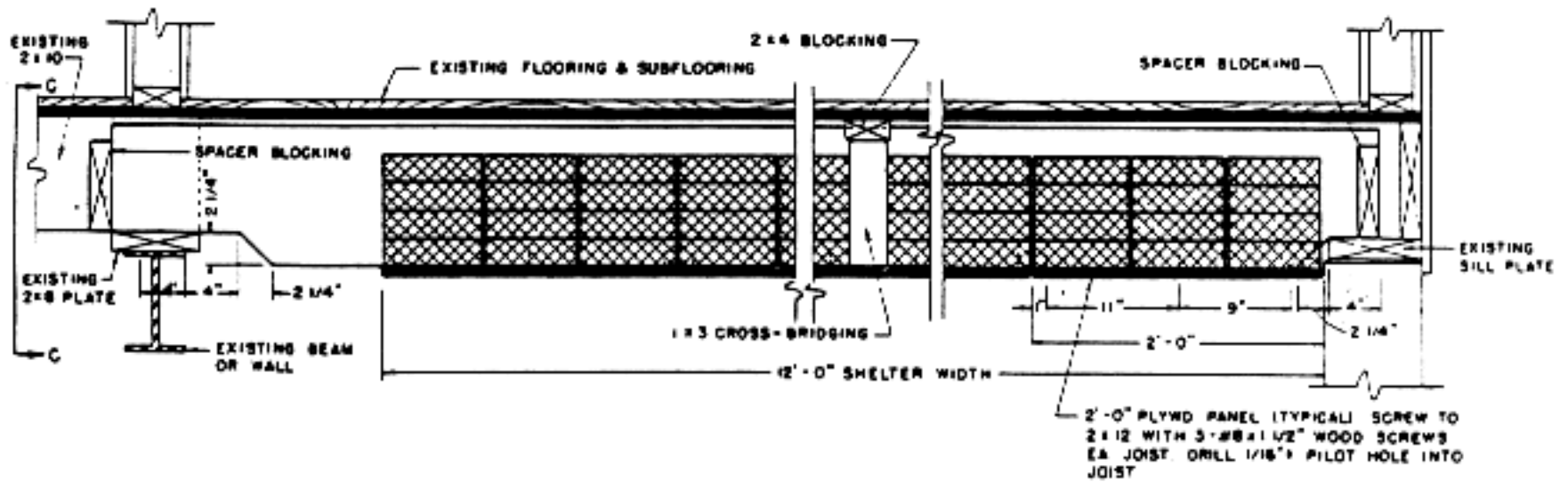

Section B

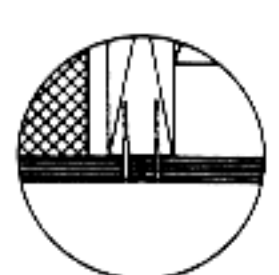
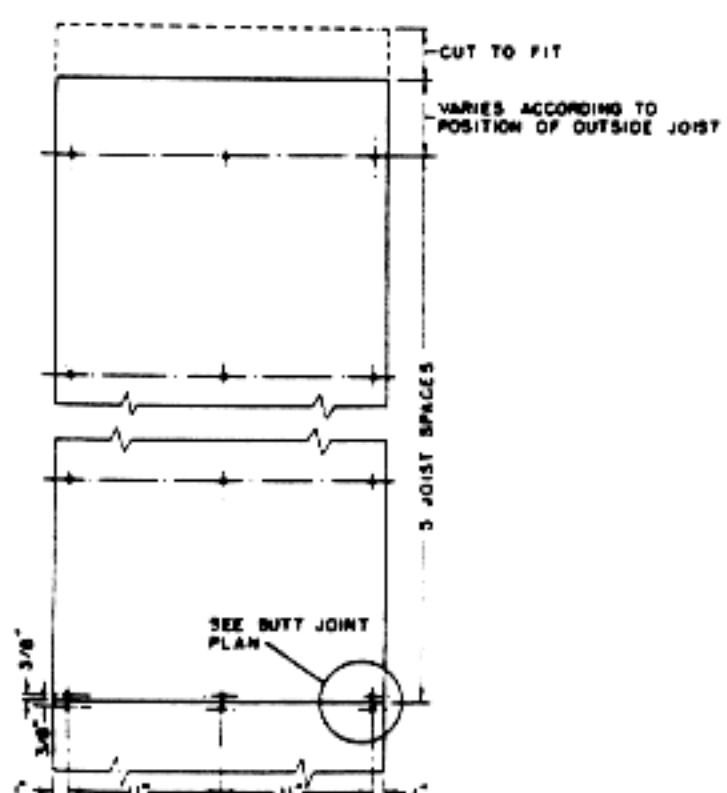

Butt joint detail

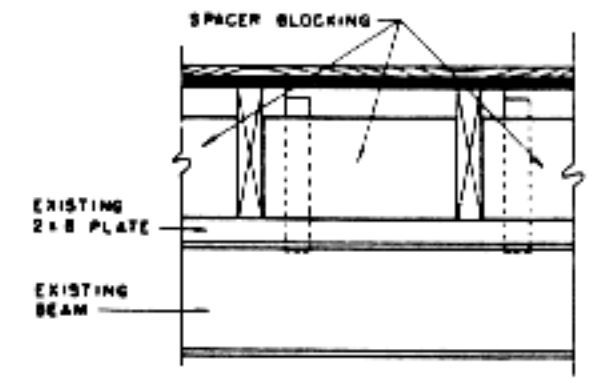

Section C

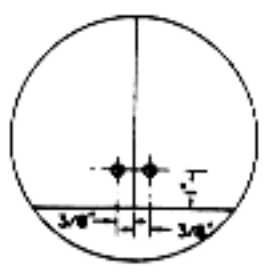

Butt joint plan

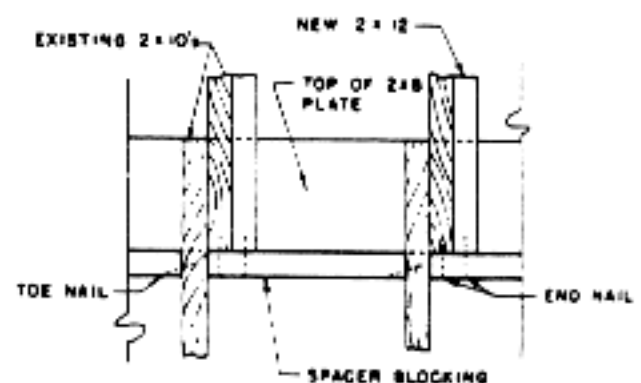

Plan detail of spacer blocking

Plan of typical plywood ceiling panel

# LIST OF MATERIALS

## MASONRY

2 - 1/4" X 4" X 8" solid bricks

2592

1944

## LUMBER

(construction or No. 1 grades or better)

New joist 2 X 12 cut to fit existing span

14

11

Blocking 2 X 8 X 1; - 0 - 3/4" (cut to fit)

24

18

2 x 4 x 1' - 0" - 3/4"

12

9

PLYWOOD SHEETS

12

6

1/2" X 8' - 0" sections

6

2' - 0" X 8' - 0" sections

## HARDWARE

38 x 2" CAD. PLATED WOOD SCREWS

288

216

16D COMMON NAILS

3 LBS.

3 LBS.

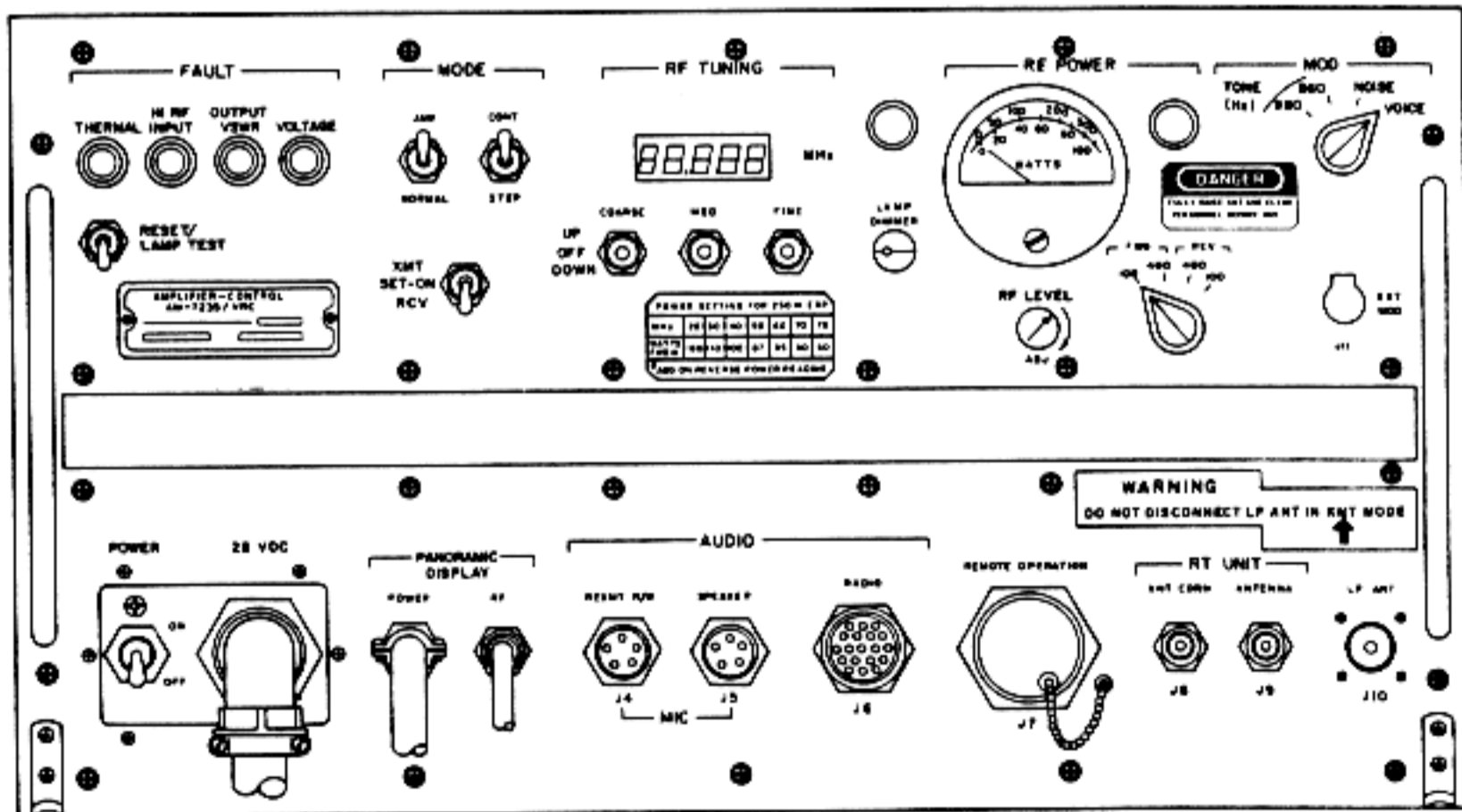

Your radio receiver and transmitter doesn't seem to work? Look closely at the "OLD" style U.S. military Amplifier control panel under MODE, do you see JAM? or MOD on the right top, do you see NOISE? This is an extremely powerful and small unit that can not only send or receive but can also OVER POWER your weak civilian signal easily. (Transmission or Receive) In order for a government locator truck to find your shelter you must transmit for 10 seconds for them to "generalize" your location and focus in on your area and one more time for 10 seconds to pin point your location, + or - 5 meters



# CHAPTER 8

---

## BASEMENT HOME FALLOUT SHELTER



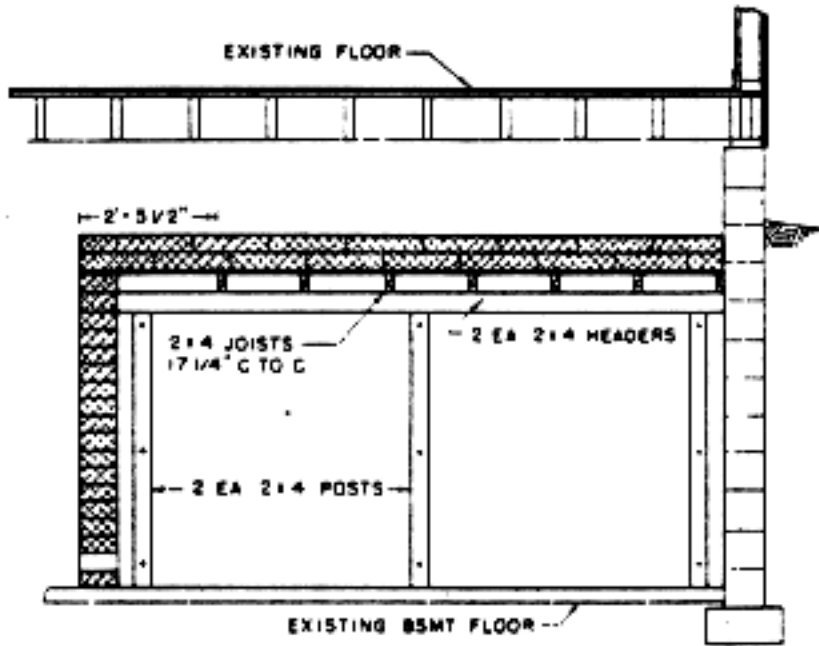

Section A

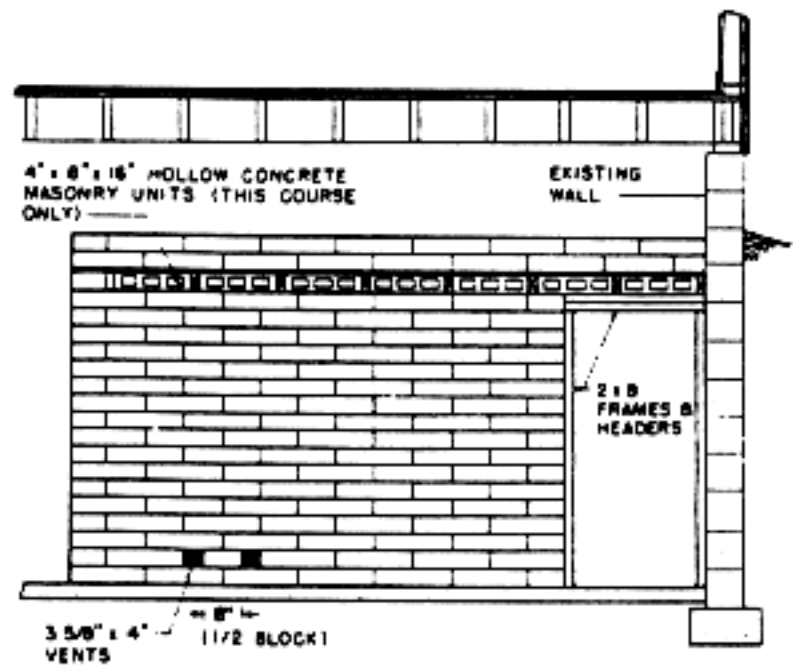

Section B

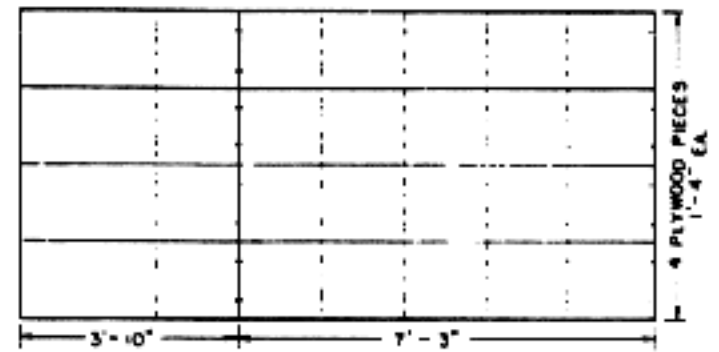

Plan of Plywood Ceiling

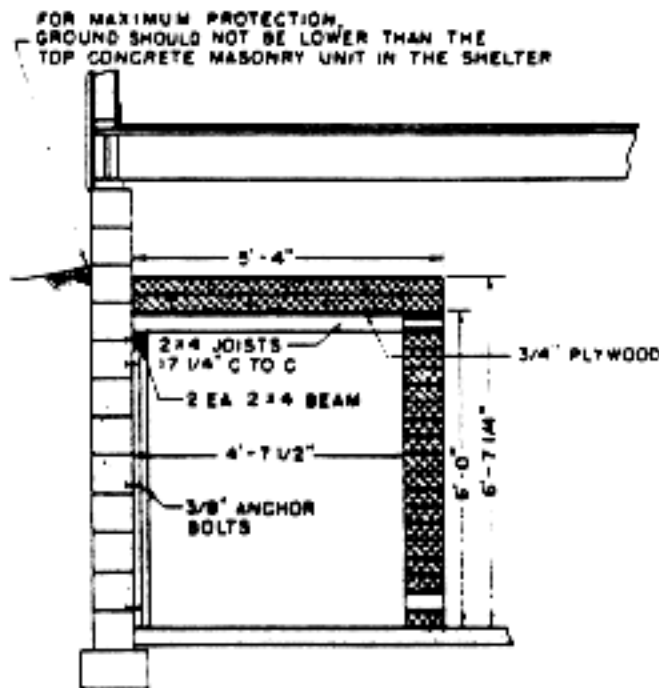

Section C

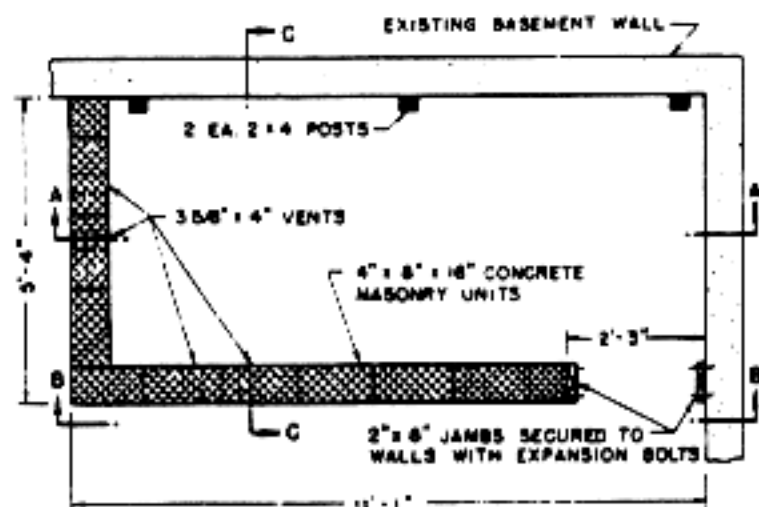

Plan

---

## **GENERAL INFORMATION**

This compact basement shelter will provide low cost protection from the effects of radioactive fallout. Its purpose is to provide adequate protection for the minimum cost in an existing basement. In addition to the low cost, materials should be readily available, and the labor time will be short.

## **TECHNICAL SUMMARY**

This shelter has about 50 square feet of area, 300 cubic feet of space and will provide shelter for five persons.

The materials required to build this shelter are obtainable at local concrete block plants and or lumber yards.

Natural ventilation is provided by the entrance way and the air vents in the shelter wall.

Estimated construction time for the basic shelter is less than 44 man hours.

## **CONSTRUCTION SEQUENCE**

1. Lay out guidelines with chalk on basement floor for shelter walls.
2. Lay first course of 4" X 8" X 16" solid blocks in a full bed of mortar to make that walls 8" thick. Vary the thickness of mortar bed if basement floor is not level.
3. Set door frame in place and continue to lay wall blocks. Be sure to leave the 4" spaces for air vents as shown on the drawing.
4. Continue this procedure until the walls have been laid up to a height of 5' - 8" (17 courses). This height can be increased, if the basement headroom permits and provided the shelter roof remains below the outside ground level.
5. Fasten posts and door frame to the basement wall using two expansion anchors and bolts for each. Be certain the post rest on the floor.
6. Nail two 2 X 4 boards together to make the wall beam. Nail to the beam on top of the post and secure with expansion anchors and bolts to the wall.
7. Place wood joist in position and secure with nails.
8. Place the 4" X 8" X 16" hollow blocks between joist as shown on the drawings. The holes in the blocks will afford ventilation.
9. Put several 3 / 4" pieces of plywood on the joints as shown and nail them to the joints with 8d nails.
10. Lay two layers of solid 4" X 8" X 16" blocks flat on top of the plywood; stagger the joints. Mortar is not required in the ceiling.
11. Continue procedures 9 and 10 until the roof is completed.
12. Additional blocks stored in the shelter are for stacking in the entry way after occupancy.

## **SPECIAL TOOLS**

3 / 4" star drill for 3 / 4" X 2 - 7 / 8" anchor bolts.

# MATERIALS LIST

## MASONRY

4" X 8" X 16" solid concrete masonry units or	296 blocks
2 - 1 / 4 X 4" X 8" solid bricks	1776 bricks
4" X 8" X 16" hollow concrete masonry units	7 blocks

## LUMBER

(construction or No. 1 grade or better)

Posts 2 X 4 X 5' - 4"	6
Joists 2 X 4 x 5' - 4"	7
Beams 2 X 4 X 10' - 5 - 1 / 2"	2
Frame 2 X 8 X 5' - 4 - 3 / 8'	2
Header 2 X 8 X 2' - 3"	2
Plywood 1" - 4" X 6' - 9 - 1 / 4" X 3 / 4" (utility B-C grade)	4
Plywood 1" - 4" X 4' - 3 - 3 / 4" X 3 / 4 (utility B-C grade)	4

## HARDWARE

3d nails	2 pounds
10d nails	2 pound
3 / 8" bolts size multiple expanding machine bolt anchors.	18
3 / 8" X 3 - 1 / 2" square head unfinished anchor bolts.	18
Mortar (prepared dry mix bags)	9 bags



# CHAPTER 9

## BASEMENT

### HOME FALLOUT SHELTER



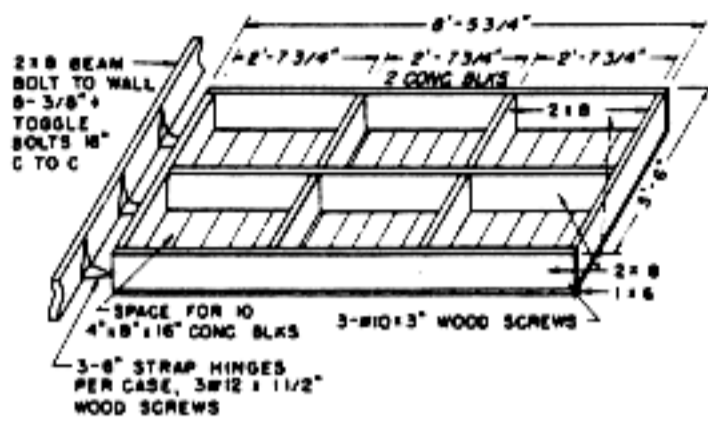

Wood case - Typical 3 cases req'd

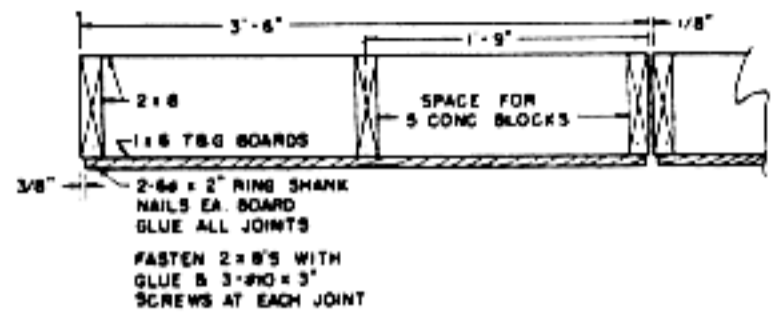

Wood case detail

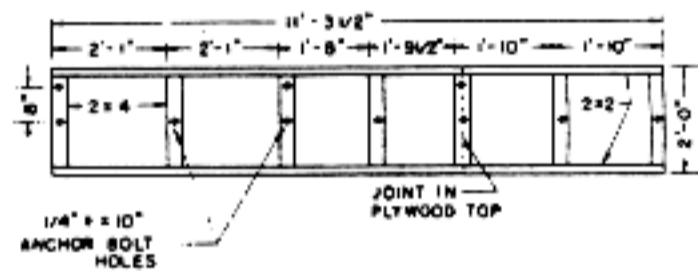

Plan of counter top frame

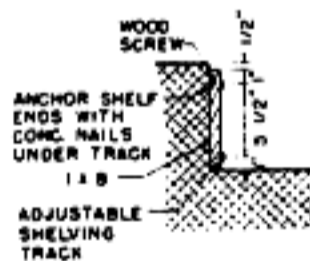

Plan detail of shelf support

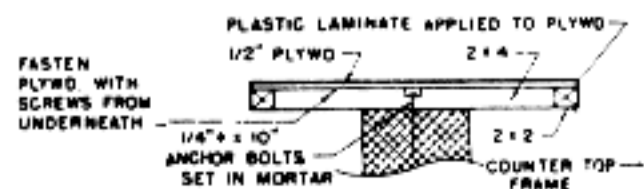

Counter top detail

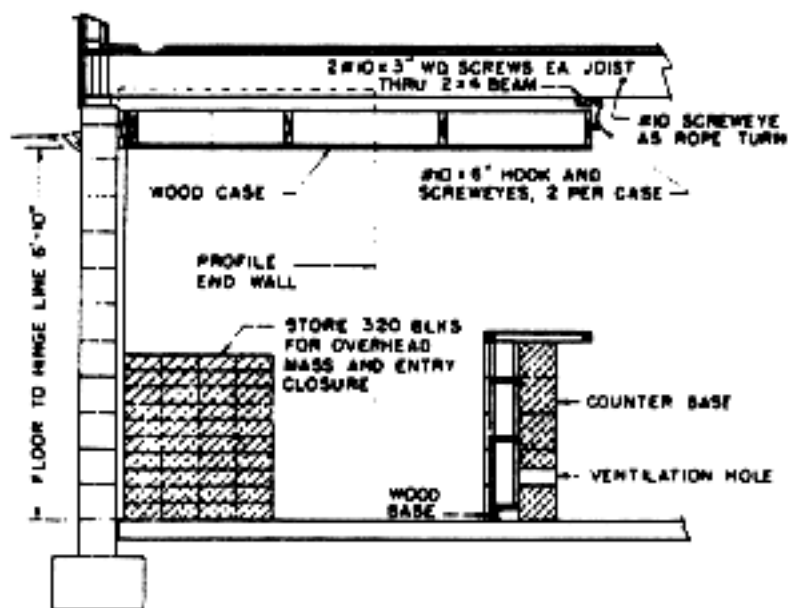

Bar Section A-1

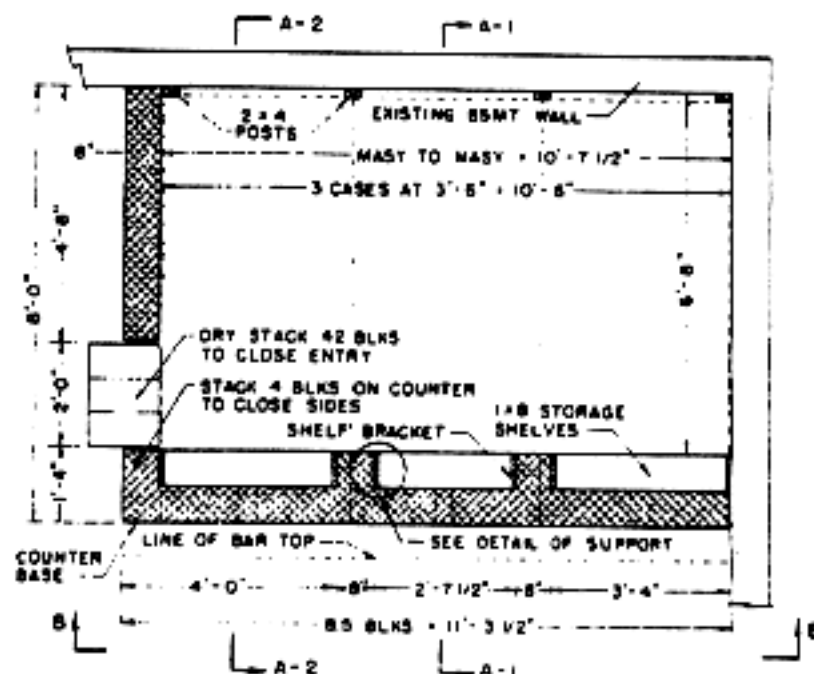

Plan

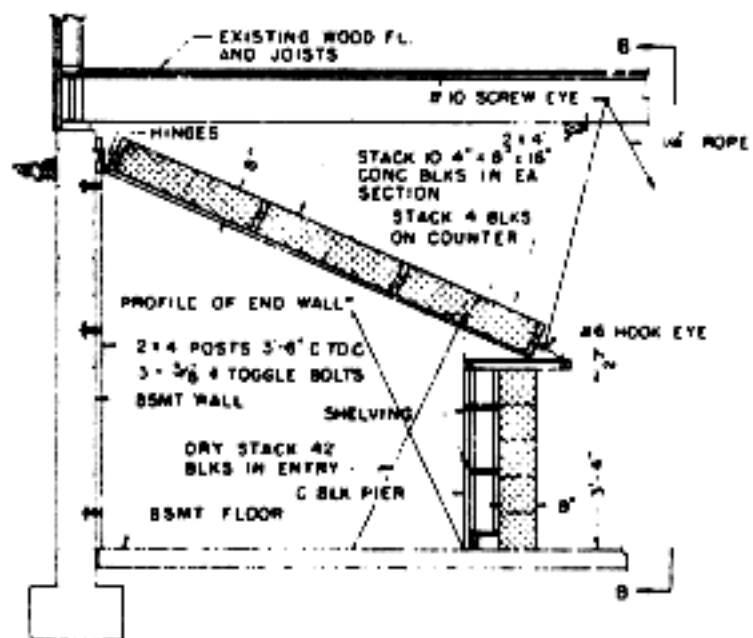

Section A-2

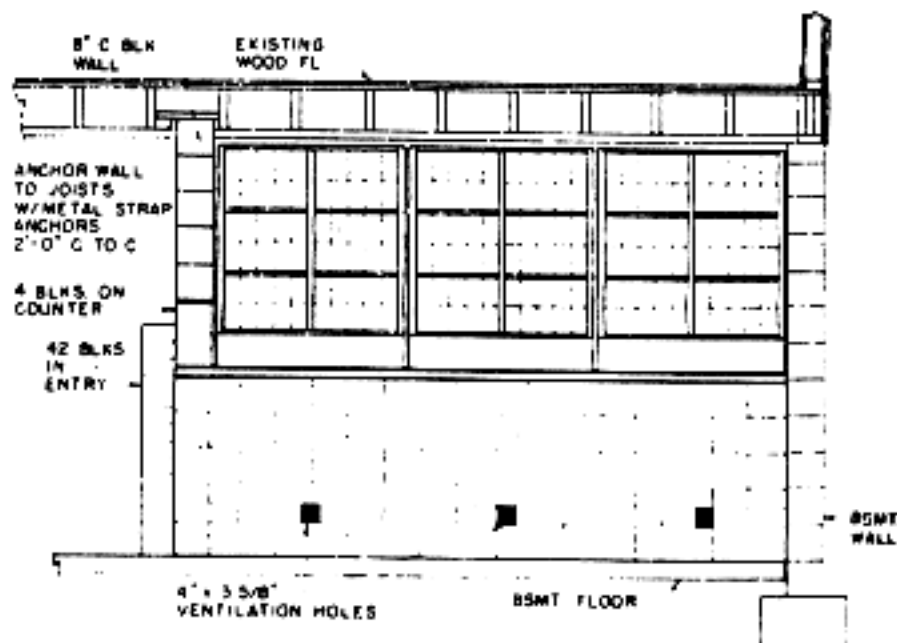

Section B

---

## **GENERAL INFORMATION**

The principal feature of this shelter is a sturdy wood overhead canopy which serves as part of a pre-built snack bar in a basement recreation room. Consisting of three units hinged to the back wall, the canopy can be lowered to rest on the snack bar in an emergency.

In basements where the level of the outside ground is above the top of the canopy, adequate shelter from fallout radiation is provided for 5 people when the canopy is filled with 8" solid concrete blocks or brick.

The snack bar should not take more than 5 man days to construct

## **CONSTRUCTION SEQUENCE**

1. Prepare wood canopy units.
  - a. Assemble units in accordance with drawings on sheet 2.
  - b. Fasten hinges to hinged boards with 1 - 1 / 2" # 12 wood screws. (drill lead holes 5 / 32" in diameter, 1 - 3 / 8" deep and shank lead holes 3 / 16" in diameter, 3 / 8" deep.
  - c. Locate and drill holes in basement wall to receive toggle bolts.
  - d. Bolt hinged boards and posts to wall with toggle bolts.
  - e. Fasten the three wood canopy units to hinges with 1 - 1 / 2" #12 wood screws. ( drill lead holes 5 / 32" in diameter, 1 - 3 / 8" deep and shank lead holes 3 / 16" in diameter, 3 / 8" deep.
2. Prepare snack bar and walls.
  - a. Lay up end wall and counter base using concrete blocks or brick, building in anchor bolts for counter tops. Note drawings show material for base as concrete blocks. Brick, however can also be used.
  - B. Assemble counter top frame.
  - c. Bolt counter top frame to counter base with anchor bolts.
  - d. Fasten plywood with plastic laminate to counter top.
  - e. Assemble wood shelves and supports.
  - f. Paint or varnish wood as desired. Use grain sealer for first coat. Shelter is now ready for use when and if needed.
3. Assembly of shelter (emergency actions)
  - a. Unhook and lower canopy to counter top using rope.
  - b. Fill canopy unit with blocks or bricks.
  - c. Occupy shelter and fill entry with blocks or bricks.



# LIST OF MATERIALS

## MASONRY

4" X 8" X 16" solid concrete masonry units or	720 blocks or
2 - 1 / 4" X 4" X 8" solid bricks	4320 bricks
prepared dry mix bags (construction or No. 1 grades or better)	3 bags

## LUMBER

Posts 2 X 4 X 6' - 10"	4 pieces
Beams 2 X 8 X 10' - 6"	1 pieces
Cases 2 X 8 X 8' - 5 - 3 / 4"	6 pieces
2 X 8 X 8' - 2 - 1 / 2"	3 pieces
2 X 8 X 3' - 2 - 3 / 4"	6 pieces
2 X 8 X 1' - 6 - 9 / 16"	12 pieces
1 X 6 X 3' - 6" T&G boards (square edge boards may be used)	60 pieces

## COUNTER TOP

Edge frame 2 X 2 X 11' - 3 - 1 / 2"	2 pieces
Center frame 2 X 4 X 1 - 8 - 3 / 4"	7 pieces
2' X 11' - 3 - 1 / 2" X 1 / 2" plywood (good one side)	1 pieces

Plastic laminate if desired

## SHELVING

Uprights 1 X 8 X 3' - 4" boards	6 pieces
Wood base 2 X 4 X 3' - 2 - 3 / 4" stress-grade lumber	1 pieces
2 X 4 X 2' - 6 - 1 / 2"	1 pieces
2 X 4 X 3' - 3 - 1 / 4"	1 pieces
Shelves 1 X 8 X 3' - 2 - 1 / 4"	3 pieces
1 X 8 X 2' - 6"	3 pieces
1 X 8 X 3' - 2 - 3 / 4"	3 pieces

## HARDWARE

3" X 8" X 1 / 8" unfinished steel strap hinges	9 pieces
#12 X 1 - 1 / 2" wood screws, c.s.	72 pieces
3 / 8" diameter X 6" square head unfinished toggle bolts	16 pieces
6d ring shanked nails	4 pounds
#10 X 3" wood screws, c.s.	72 pieces
Glue, protein emulsion (must develop 450 lbs. / sq. in.)	1 - 1 / 2 pints
8d finish nails	2 pounds
1 / 4" diameter X 10" square head unfinished anchor bolts	10 pieces
#10 X 6" steel hook and screw eye sets	6 pieces
#10 X 6" steel screws eyes	6 pieces
1 / 4" hemp rope, 80 lbs. test	12 feet

# CHAPTER 10

## BASEMENT

### HOME FALLOUT SHELTER

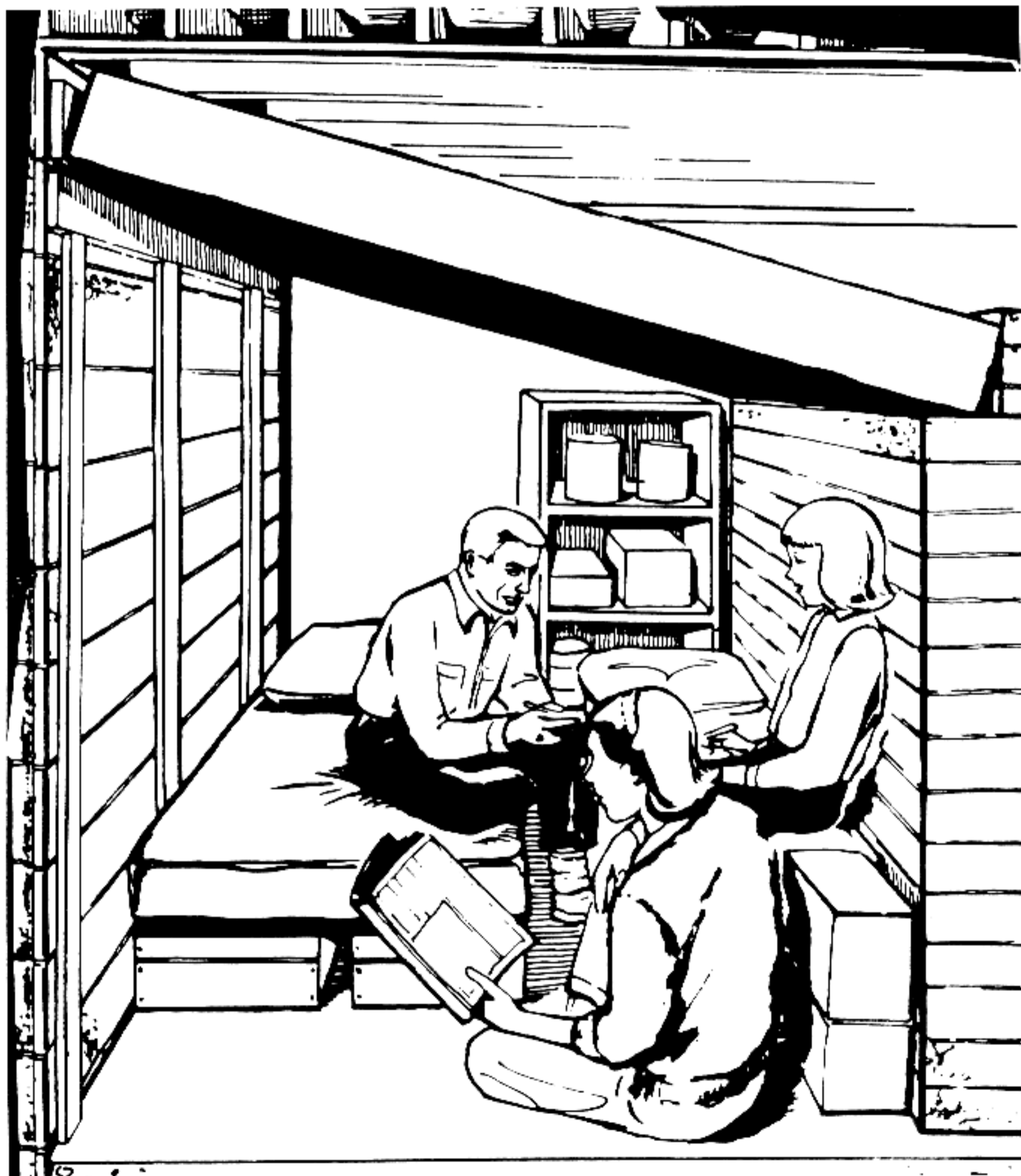

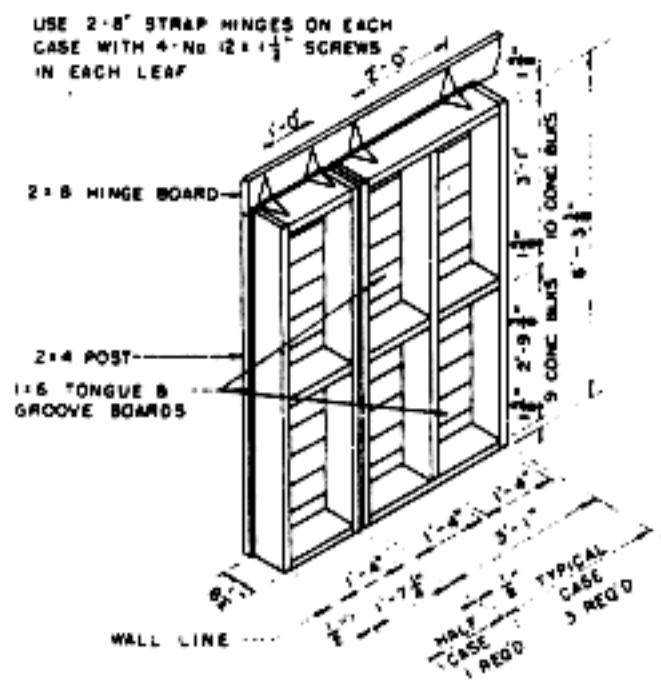

Isometric of cases

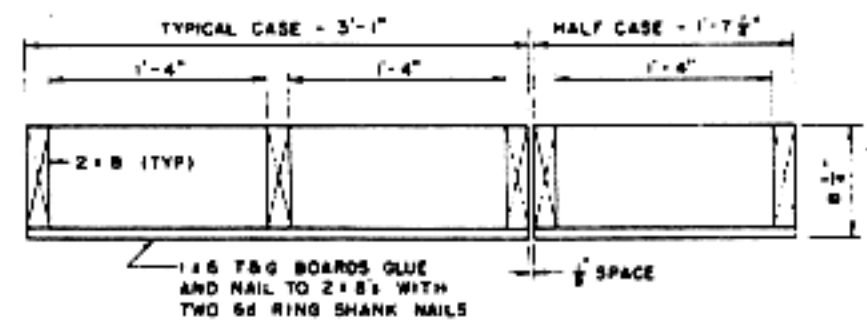

Detail Sections

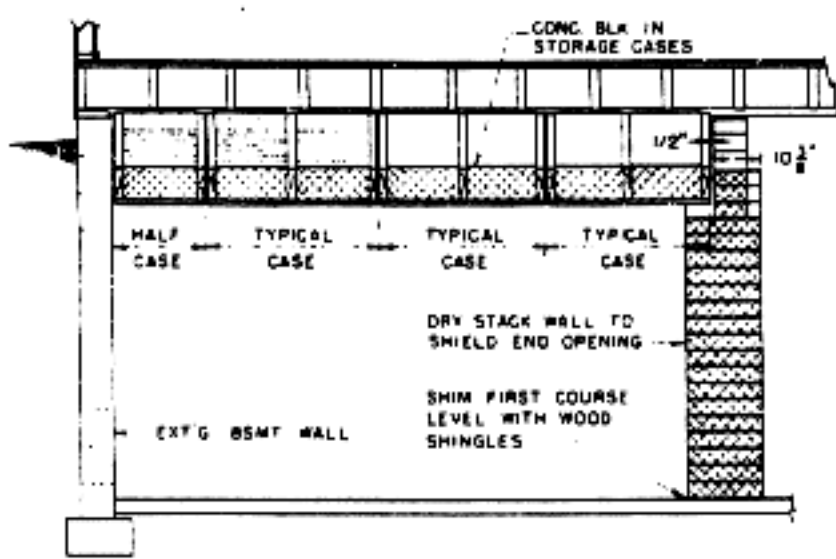

Section A-1

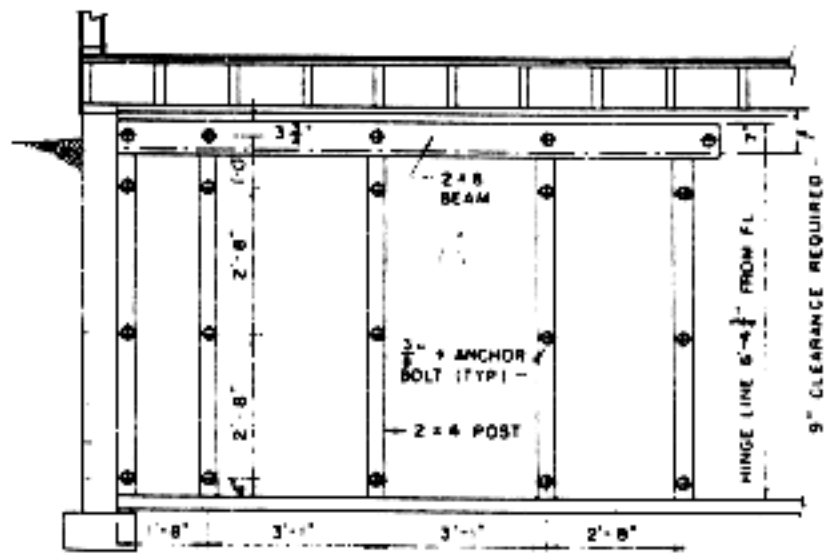

Section A-2

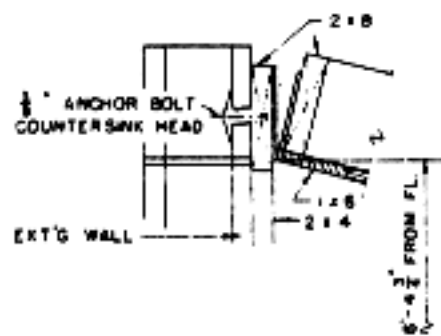

Hinge Detail

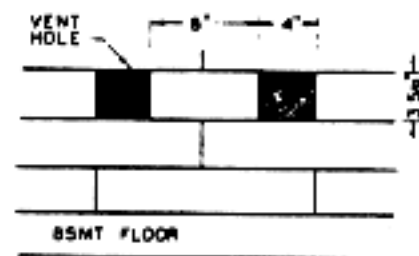

Air Vent Detail

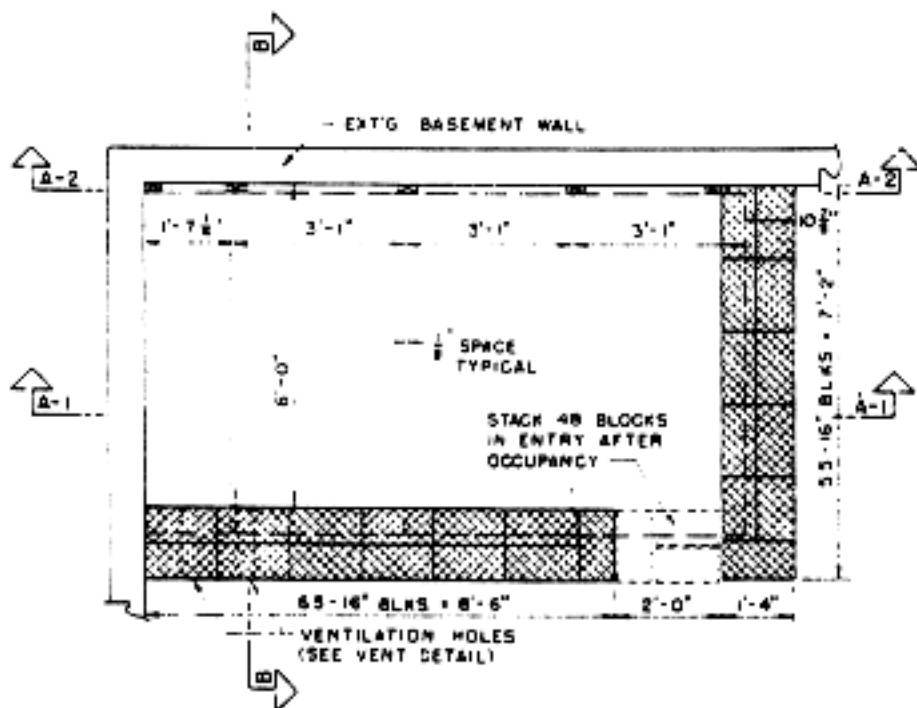

Plan

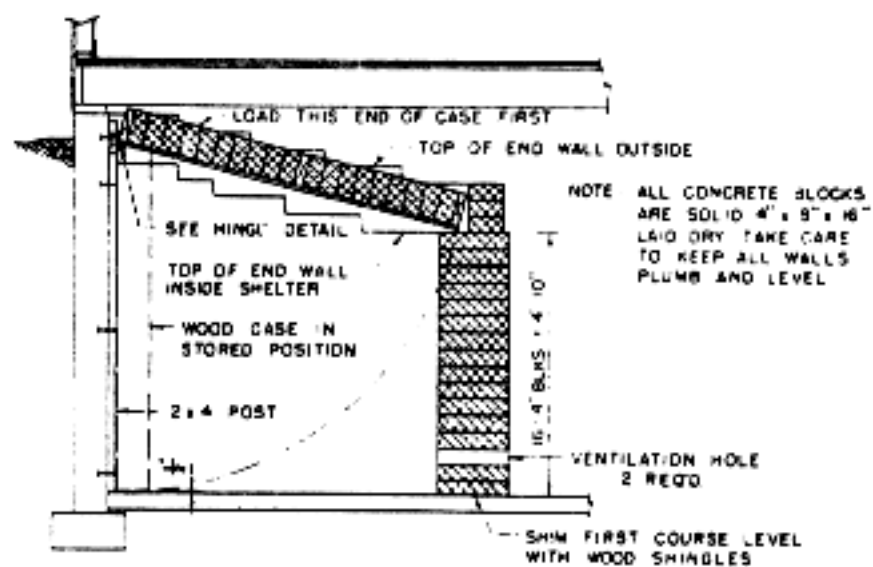

Section B



---

## **GENERAL INFORMATION**

The principal feature of this shelter is a roof composed of tilt up storage units, the top of which is hinged to the wall. The units can be used as book cases, pantry shelves, or for miscellaneous storage. In an emergency, the storage units can be tilted up so that they rest on a stacked masonry wall built from materials stored nearby the units.

In basements where the outside ground levels is above the top of the tiled up units, adequate shelter from fallout radiation is provided by filling the units with brick or solid concrete blocks 8" thick. The shelter will house 6 people.

Approximately 2 man days are required to construct the storage units. The material are readily available, from retail lumber yards.

## **CONSTRUCTION SEQUENCE**

1. Prepare wood case units.
  - a. Assemble wood units in accordance with drawings.
  - b. Fasten hinges to hinge board with 1 - 1 / 2" #12 wood screws.
  - c. Locate and drill holes in basement walls to receive machine bolt anchors.
  - d. Bolt hinge board and 2 X 4 posts to wall with 3 / 8" anchor bolts.
  - e. Fasten wood case units to hinges with 1 - 1 / 2" #12 wood screws.
2. Provide suitable storage location for required concrete blocks.
3. Assembly of shelter.
  - a. Remove items stored from wood case units.
  - b. Mark location of shelter walls on floor with chalk.
  - c. Move concrete blocks to shelter location
  - d. Lay first course of blocks for shelter walls, shimming blocks as required with wood shingles until course is Level. It is important that the wall be stacked as nearly level as plumb as possible for stability.
  - e. Tilt up case units in corner of basement and support temporarily with 2 X 4 prop or household step ladder. Build up 16" concrete brick wall to support case units.
  - f. Remove prop, lower case units to block wall and fill case unit with concrete blocks.
  - g. Build end wall up above the side of the end storage unit.
  - h. Move 48 concrete blocks into shelter.
  - i. Occupy shelter and fill entry with 48 blocks.

# LIST OF MATERIALS

## MASONRY

4" X 8" X 16" solid concrete masonry units or	575 Blocks or
2 - 1 / 4" X 4" X 8" solid bricks	3450 Bricks

## LUMBER

(construction or No. 1 grades or better)

Post 2 X 4' - 4 - 1 / 4"	5 pieces
Beam 2 X 8 X 10' - 11 - 5 / 8"	1 piece
3 cases plus half case	
2 X 8 X 6' - 3 - 3 / 8"	8 pieces
2 X 8 X 6' - 0 - 1 / 8"	3 pieces
2 X 8 X 1' - 4"	9 pieces
2 X 8 X 2' - 9 - 5 / 8"	6 pieces
1 X 6 X 1' - 7 - 1 / 4" T & G	13 pieces
1 X 6 X 3' - 1" T & G	39 pieces

## HARDWARE

3" X 8" X 1 / 8" unfinished steel strap hinges	8
#12 X 1 - 1 / 2" wood screws, o. c.	64
3 / 8" diam. X 6" square head unfinished anchor bolts	20
3 / 8" bolt size multiple expanding machine bolt anchor	20
6d ring shanked nails	3 pounds
Blue, protein emulsion (must develop 450 lbs. sq. in.	1 - 1 / 2 pint
16d common nails	3 pounds

## SPECIAL TOOLS;

Bubble level to insure wall is level as it is stacked

3 / 4" star drill for making anchor holes in existing basement wall.

# CHAPTER 11

## BASEMENT

### HOME FALLOUT SHELTER

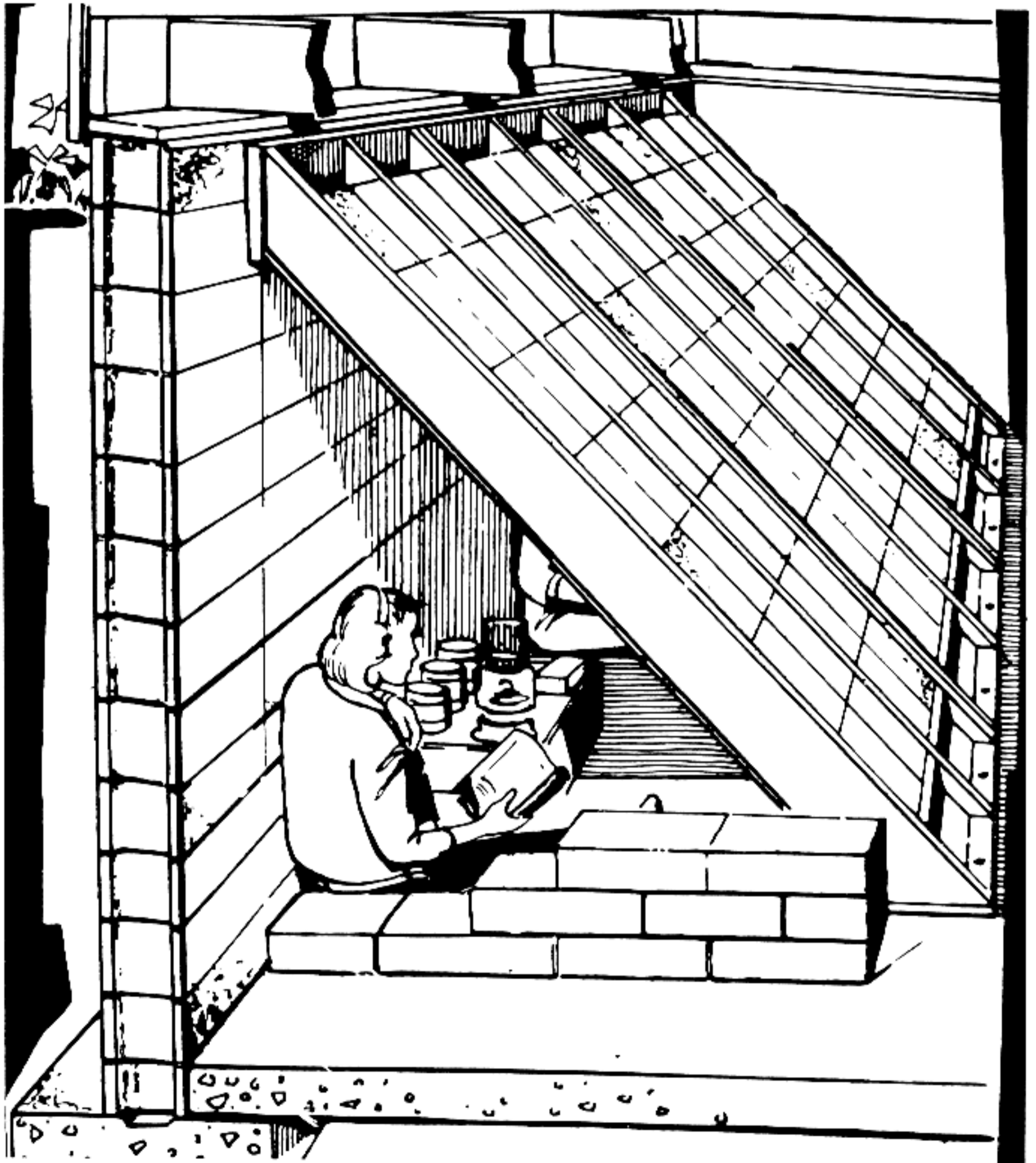

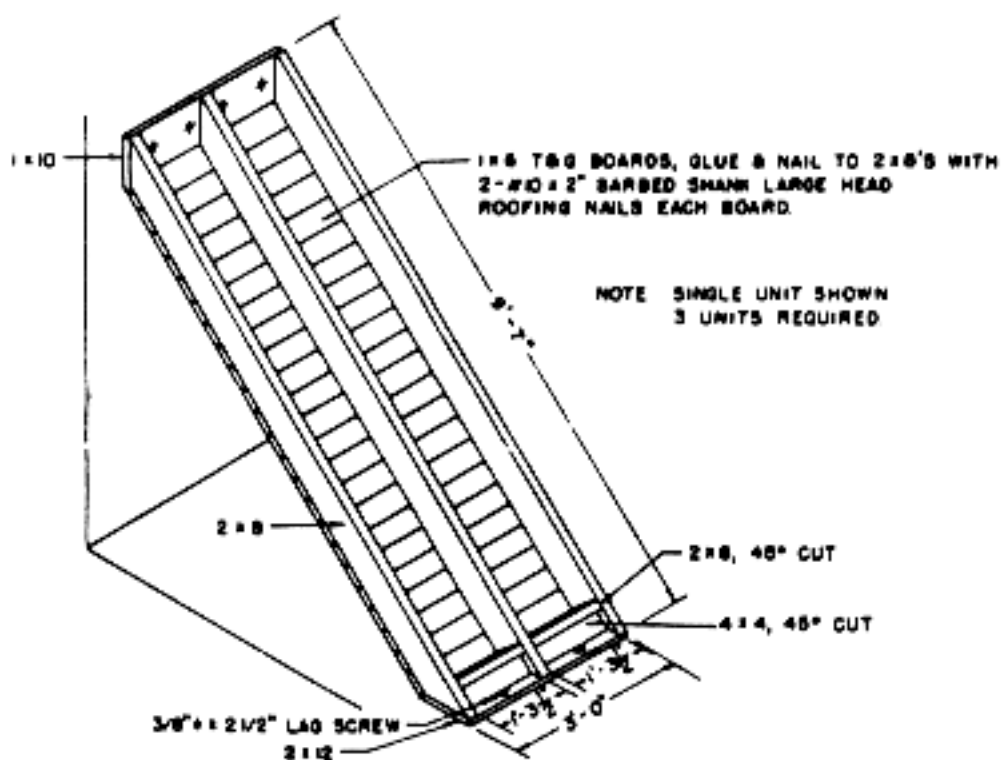

Isometric of Lean-To Unit

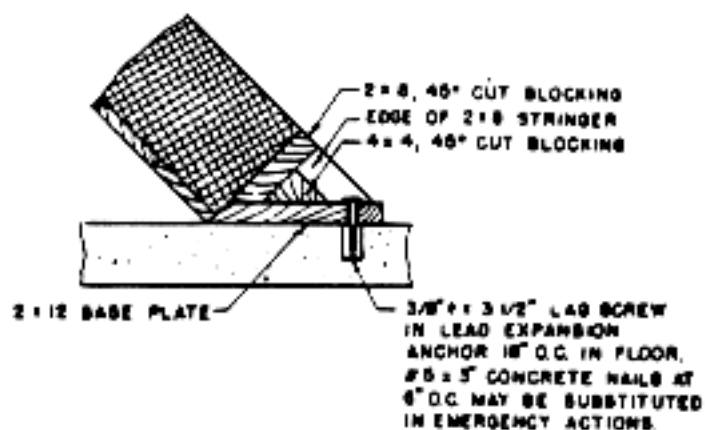

Detail

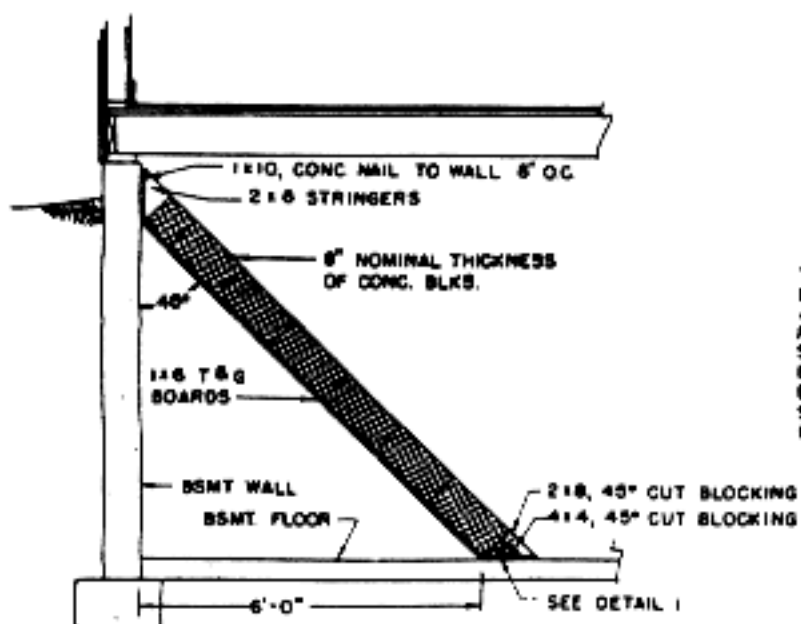

Section A

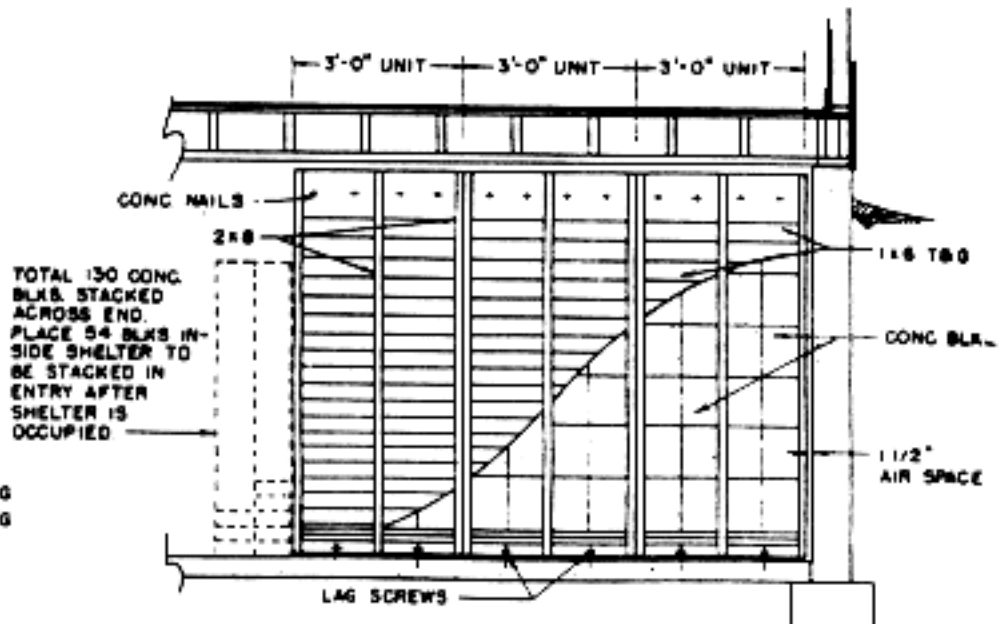

Front Elevation

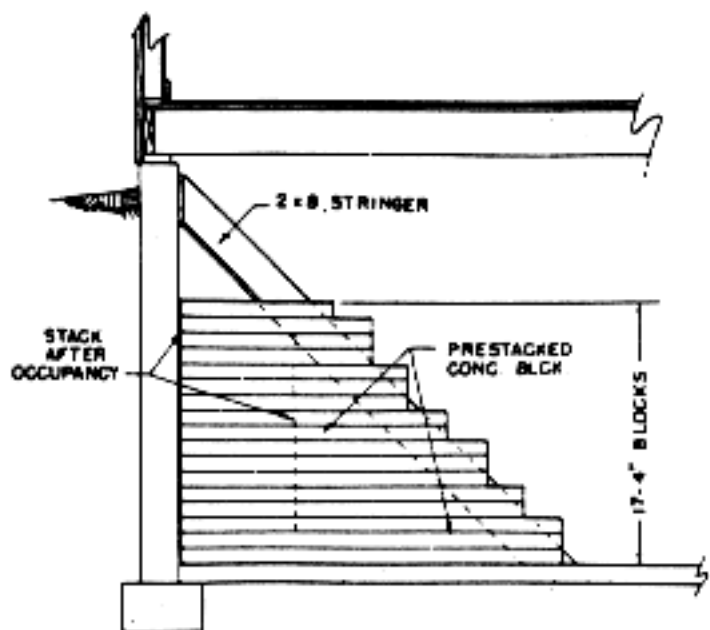

End Elevation

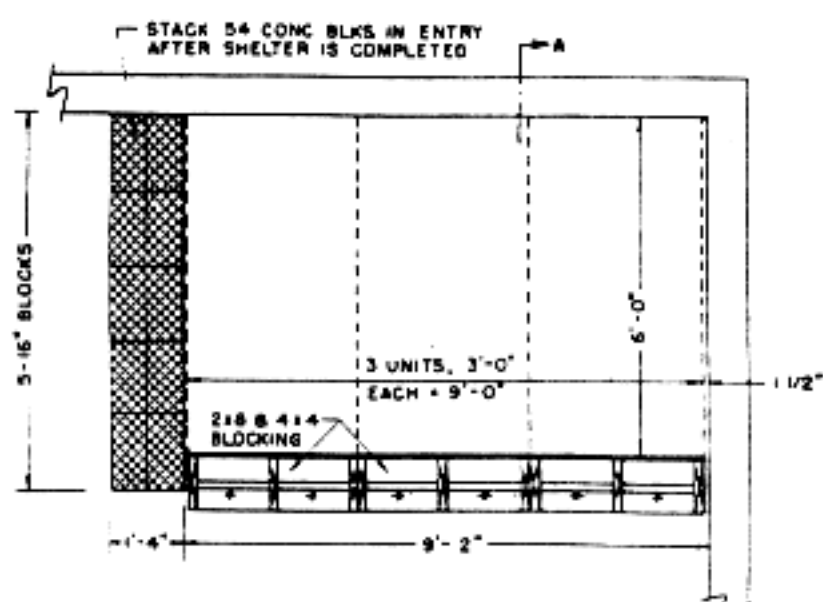

Plan



---

## **GENERAL INFORMATION**

This shelter is designed to provide protection from the effects of radioactive fallout in the below grade basement of an existing house. Its advantages are low cost, simplicity of construction, general availability of material, and the fact that it may be easily disassembled.

## **TECHNICAL SUMMARY**

This shelter design will provide 54 sq feet of area and approximately 216 cubic feet of space. It will house three persons. The shelter length can be increased by increments of 3 foot panels. The height may be increased by the use of more materials. This increase will be limited by basement height and handling of the panels.

The materials necessary to construct this shelter should be available from retail lumber yards.

Natural ventilation is obtained by omitting 3 blocks for the top of the entrance way closure and by leaving a 1 - 1 / 2" in. gap between the end of the shelter and the basement wall.

Construction time should not exceed 20 man hours when all the materials are on hand at the shelter location. It is desirable to pre-assemble the lean to units and store them in a corner. They can then be installed in the best corner of the basement and stacked with blocks in 1 hour.

## **CONSTRUCTION SEQUENCE**

### **1. Prepare shelter units.**

- a. Cut 45 degree bevels on 2 X 8 stringers. Arrange in 3 foot panels using 16d common nails, attach bottom boards and blocking on the beveled ends first.
- b. Fit in, glue and nail remaining bottom boards with large head roofing nails.
- c. Units can be stored assembled, if desired, to save time. It is desirable to locate lag screw holes and install lead shields in floor and basement wall.

### **2. Assemble shelter (emergency actions)**

- a. Turn this panel right side up and place it in its permanent position. Fasten the panel to the floor with lag screws in lead shields leaving a 1 - 2 / 2" gap between the end of the shelter and the basement wall. If lead shields have not been installed ahead of time, use concrete nails as shown in the detail.
- b. Fasten in sequence as many panels as are to be used. Nail to wall with concrete nails.
- c. Fill panels with 2 layers of solid concrete blocks or bricks starting at bottom.
- d. Build end wall of 76 stacked blocks, 456 bricks.
- e. Place 50 blocks or 300 bricks in the shelter for emergency closure of entrance way.

# LIST OF MATERIALS

## MASONRY

4" X 8" X 16" solid concrete masonry units or	290 Blocks or
2 - 1 / 4" X 4" X 8" solid bricks	1740 Bricks

## LUMBER

(construction or No 1 grades or better)

Stringers 2 X 8 X 9' - 7" (45 degree diag. cut at both ends)	9 pieces
Boards 1 X 6 X 3' - 0" T & G (square edge may be used)	69 pieces
1 X 10 X 3' - 0"	1 pieces
2 X 10 X 3' - 0"	1 pieces
Blocking 2 X 8 X 1' - 3 - 1 / 2" stress grade lumber	6 pieces
4 X 4 X 1" - 3 - 1 / 2" (rip lengthwise at 45 degrees to provide the 6 pieces required)	3 pieces

## HARDWARE

3 / 8" diam. X 2 - 1 / 4" lag screws and washers	12
3 / 8" bolt size lead expansion shield, 9 / 16" X 2" hole	12
#10 ga. X 2" barbed shank, large head roofing nails	3 pounds
16d common nails	1 pounds
Glue, protein emulsion (must develop 450 lbs. sq. in.)	1 - 1 / 2 pint
#5 X 3" concrete nails	36

## SPECIAL TOOLS;

9 / 16" star drill to install anchor bolts into concrete basement floor and walls.

### ***DON'T FORGET: Planning ahead saves money***

**TOP COVER** Use some kind of disguise to eliminate your shelters being detected, whatever you do, don't use any plant that produces food, no sense in having every kid in the neighborhood picking berries right on top of your secret shelter. I don't recommend them but there are poisonous plants that will irritate or can even kill an intruder, plants like stinging nettles, poison ivy, oak, sumac, and ragwort, are skin irritants producing a delayed reaction before rash develops. Plants that may produce death with skin contact of the mature leaves, stem or sap, Giant Hogweed (*Heracleum Mantegazzianum*) Sun Spurge (*Euphorbia Helioscopia*) are extremely toxic plants, even with the most casual contact. Thorn plants are a immediate deterrent and require little cultivation on your part once they have established themselves. If you chose foliage that is thorny, pick a plant that will remain throughout the year, like a woody stemmed plant. Remember anything you can do to reduce access to the area of your shelter will increase your chances of keeping your Survival shelter a secret.



*Don't forget to lace the area around your shelter with metal chips*

**AIR** I recommend you construct a reliable air filtration system or buy one already constructed. No open air pipes, all piping must have valves to seal off your shelter. This is the most important life support system you have. Look at it this way, skimp now and whatever your enemy could dream up to use against you will work. Many Natural disasters will dictate a complete valve closure to eliminate any chance of toxic particles or gases from fires Etc. If chemical, Nuclear, bio pollutants are present, you and your family will suffer the consequence without sealing valves. Subscribe to ***Mother Earth News***, it tells you how to live off the land, build the most amazing stuff like "AIR SCRUBBERS" for Survival Shelters, it's all about giving up on our pesticide polluted, industrialized, paper money world and becoming totally self sufficient.

**WATER**. Drilling for water is expensive and risky. Your shelter's location will be exposed to everyone by the huge trucks and the 50 foot high drilling tower, not to mention the ground shaking noise that can be heard for miles! Plus the fact that it will require a pump to get the water out of the ground in any quantity, remember you'll be using an old fashioned manual pump or a recreational camper battery powered pump. So build in a suitable location with spring feed drinking water near by if at all possible. If you think you will need 'just a little water' you say a five gallon jug or two will last you a week or so, I can assure you it's more like 5 gallons per person per day minimum, the more the better. You need a large quantities of good water to keep your family living a life-style that they can be comfortable with. Plan on taping into your present well or drilling or digging a new one. It is best if the well head is inside your shelter just in case there's trouble, you won't have to expose yourself outside to make the repairs. Never drink surface water after any type of major disaster, it's contaminated I guarantee it!

**FOOD** Something I do enjoy more and more as I get up in years. When I was young I could eat the most awful stuff while in the woods and enjoy it, but now that I'm 40 it seems far more important to enjoy a fine meal than to just sustain my daily existence. Call me a pig or not but good food and spices are on the top of my list of supplies. I can't tell you what to store away and in what quantities because you probably don't like what I like. I'll give you one suggestion, get as many MRE's as you can, you know the MEALS READY TO EAT the military issues to soldiers in the field. This is the most nutritious and highest energy food you will find for the cost and size, MRE's have an extremely long shelf life, for most packets it's 10 years. I love them, I take one every time I go into the woods. I have one in every vehicle I own just in case of emergency. They contain a full days supply of what ever it takes to keep you alive, even matches and toilet paper are included, just add hot water for the coffee pack or have the drink mix (KOOL-AID) even hot chocolate! I buy them by the case lot from suppliers like Pondersoa Products Box 1016 Eagle, ID. 83616 phone 208-939-1513 Remember to ask for the Manufacture Date it is important to get fresh MRE's Don't be confused by the Inspection Date, the Manufacture Date is your pricing guide, cheaper usually means your getting old or out of date MRE's. I once bought a case for 20 dollars at a gun show only to discover they were all bad, years past there expiration date, great deal right?

**SEEDS** Buy them now while they are plentifully and cheap, they will be in high demand after any large scale disaster. In fact history has shown that entire cultures have died off because hard times forced the people to eat next years seed stock. Again I can't recommend any particular variety because of the varied climates in which they will grow best.

**INSANITY** ✓ Here is a fun subject and something I know a lot about. Plan ahead for the worst case of cabin fever you can possibly imagine! It helps to read educational psychology books. Reading will occupy vast amounts of time and will help keep your family intact with fun stories, like families used to do before radio and TV. If you have children it will be your daily job to be their teacher, so prepare your children's educational library in advance. Books are very important but you should round things out with board games, cards, what ever you like, knitting, writing, Hey there is a good idea, write you entire life's story and don't leave one second out.

**TIME** ✓ Consider turning around your clock so you are awake during night hours and asleep during daylight hours? It makes perfect sense, you're in a cement box in the ground anyway. While your up cooking listening to the radio and going about your daily duties everyone else is sleeping. If you need to hunt for meat or perform a reconnaissance mission you would do it at night right. Why not let the night be your day, you would be rested and in full function at a time when your outside activities would be hardest to detect. Soon you would be quite adept to night life. Your shelter is really only designed to support a very limited number of people for a short time. Without water and sewer installation you will soon be forced to venture outside for supplies.

**HEAT DETECTION** ✓ Here is a trouble spot, they can fly over and perform spectra analysis in the infra red range to detect even a 2 degree temperature rise in air, land and sea. You should consider insulating you shelter using dense cell foam at least 2" thick and sealed between sheets using GE Silicone sealer. You will have a little harder time heating in the winter if the frost line drops below your roof slab, but it will be quite comfortable for you in the summer. The ground freezes 4 feet deep where I live and it's no problem at all. Electric heaters are out because they use too much electricity for you to make easily. I suggest a propane Recreational vehicle heater, they are extremely efficient with gas and electric because they are designed to use very small tanks of propane and run on batteries for days between charge up, they are thermostatically controlled so it will be just like home! If you are serious about making a live-able home you should try recreational vehicle dealers for your electric converters and inverters, water pumps, sinks, showers, etc.

**SEWER** ✓ Your shelter will need to have a toilet and some kind of bathing unit, once again the ones in my Winnebago are the best available for limited spaces and could be hooked up to a very small septic system (one 50 gallon main enzyme tank and 3 top feeder lines 4" dia 10' long) at least 2 feet below the floor line of your shelter. The installation of these life support devices goes beyond the scope of a shelter of this size, in an emergency it could be used with exceptional comfort, skillful pre-planning can make or break you survival experience. Let me give you an excuse to take a nice vacation! If you have never stayed a week end in a newer travel trailer or Winnebago you should do so for the experience in living in close quarters with your family. I assure you it is worth the experience, plus you'll get a good look at the miniaturized appliances that work so well on so little energy.

**IT'S A SECRET** ✓ Take this simple oath; I swear, never tell anyone about my shelter and will lie if necessary to keep from revealing the very existence of my Survival Shelter. I will never tell, it doesn't exist, I promise to tell no one, never, never, never, I will never tell.

*Right: This survivalist is showing off his entrance which is very deceptive. The pit in his garage was transformed into a very livable "Hard Shelter" Pre-planing the job of cementing his garage floor also provide a roof for his shelter. He utilized structural steel reinforcement in the cement floor which provides ample support for the shelters 12" thick roof. Although the walls and floor are of dirt, this shelter does have water and a crude waste disposal system, lights and basic furnishings.*





## ANIMAL DETECTION

Dogs are a serious threat if hostile military or police units are employed in your area. Dogs have proven very useful, they are believed to use their keen sense of smell to detect a persons scent not the scent of the equipment. This means the dogs ability to home in on your locations will be hampered by wind and weather conditions. A general rule: if the scent is more than 2 days old a police attack dogs cannot maintain scent contact. On the other hand if real tracking dogs (hounds) are employed up to a week can pass and their ultra keen senses may still track you down! The dogs natural use of his other senses like visual detection, humans see moment, dogs are believed to see and recognize outlines and shades variations, or hearing, dogs can actually hear the vibration of trip wires in the wind at one hundred yards! Even the hair on his muzzle, forelegs and chest are very sensitive to the lightest touch.

*RIGHT: The transmitter around the dogs neck is a radio tracker, allowing remote monitoring of his movements. If the dog makes a discovery it will remain in the area so troops can be alerted and dispatched. You know what to do *



## ELECTRONIC DETECTION

Portable electronic detectors used to locate buried metallic and non metallic materials are now commonly issued to military troops and police. Metallic detectors will reveal objects up to a maximum of 4 feet deep. Nonmetallic detectors can detect a change in the density of soil or materials under the ground up to 6 feet deep. Both types have limitations, they are exceptionally reliable in locating near surface objects (1 foot or less) but it takes an experienced operator to estimate the depth by the "ECHO". All metal detectors will react to any kind of buried metal like a nail or a tin can as well as a steel reinforced underground structure. A non magnetic ground density detector will give false signals when passing over tree roots or air pocket in the earth. If your shelter is near your home like in the back yard it will probably be passed off as a septic tank and no further investigation will be instituted. This would mean the total disguise of air pipes, entrances and escape tunnels so that it is not apparent there is a below ground structure.



*LEFT: Hand held magnetic detector require slow smooth patterned movement of the operator.*

*RIGHT:: Hand held Non magnetic detector will give general ground density readings. Used primarily for detection of near surface plastic mines*

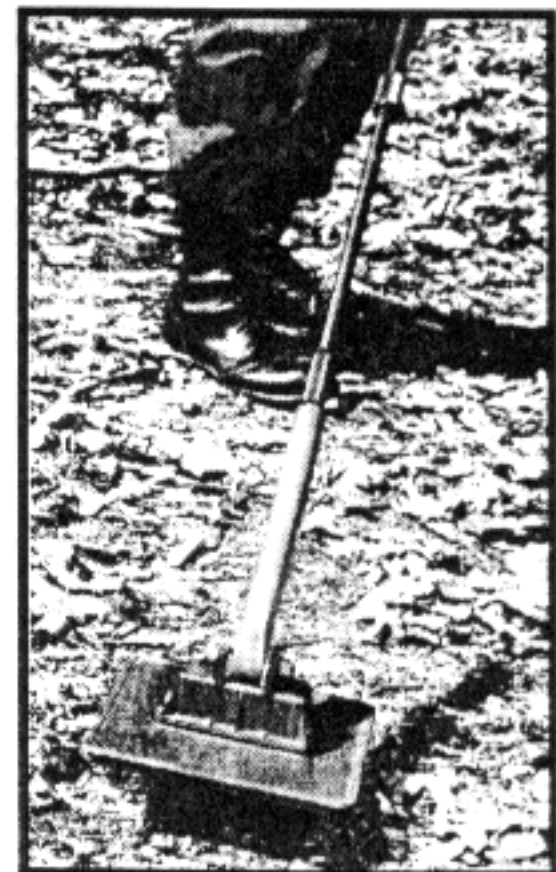

# CHAPTER 12

## BURIAL COFFINS

---

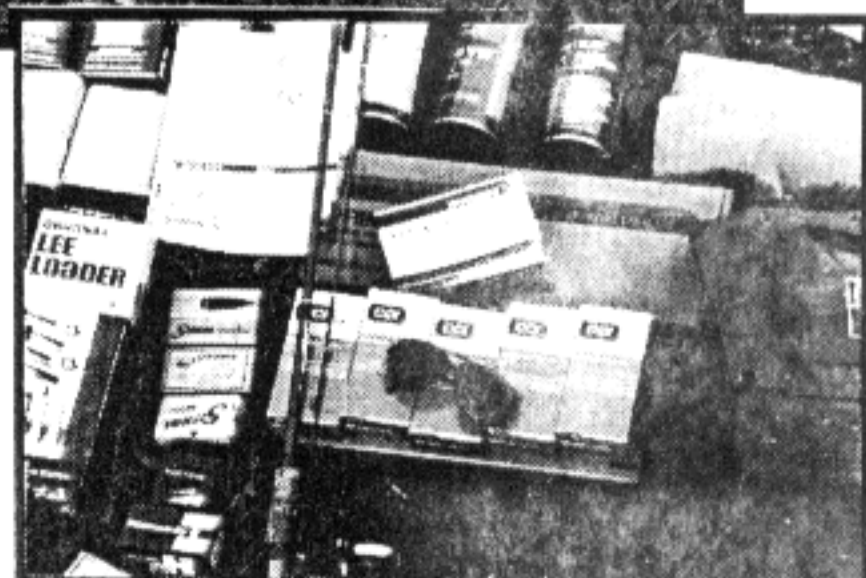
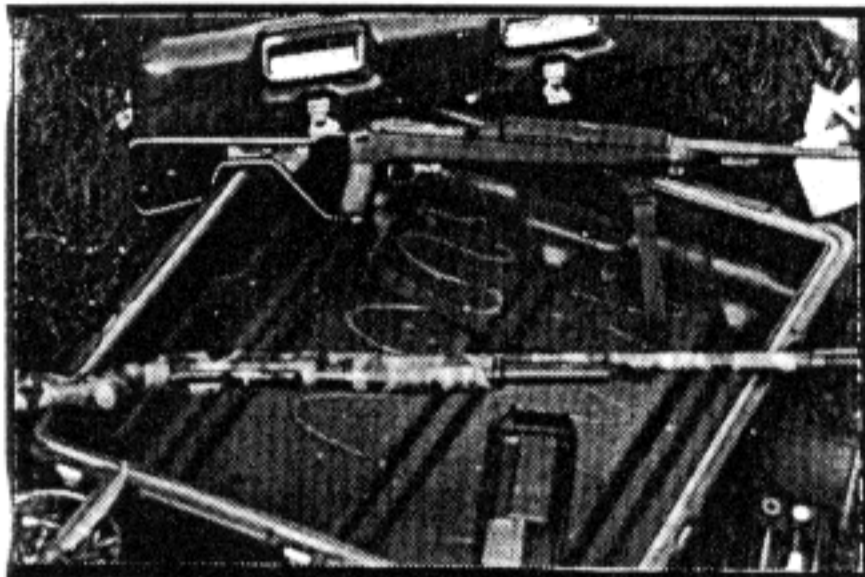



## Recent history

The Vietnamese people suffered the historic TET offensive beginning January 29, 1968 and it lasted an incredible 60 days. The Vietnamese peoples use of deadly harassment tactics that many veterans say began the end of the "Vietnamese Policing Action" for America. The preparation and timing leading up to the 1968 Tet offensive is considered even today as a paramount disaster in the American Vietnamese conflict. Why is this 30 year old war relevant to this manual? The entire world felt the America Military should not be in Vietnam and began to support the "freedom revolution" with huge sums of money, political allies in the UN, and armaments, food and supplies of all kinds! During the late 1960's and early 1970's the entire world was secretly trying to sell or give arms to North Vietnam and that arsenal included many weapons systems not seen by American troops before. Light weight "Tube Artillery", Large rockets, Large Mortars, Tanks and Armored Carriers, up to date Modern small arms (AK-47 Type), anti-aircraft artillery, Heavy machine guns and explosives of every type! What did the North Vietnamese do with an estimated 10 million metric tons of foreign military supplies? They buried much of the small munitions, guns and supplies in the South Vietnamese grave yards! Right under the noses of the American intelligence system, an absolute and total surprise to the American military forces. Think about it, no one likes to visit a grave yard, let alone the fact that you are going to be digging up coffins. Why would anyone put a grave yard under surveillance, everybody's dead? The brilliant planning the Vietnamese people used in the Tet offensive was also the perfect tactic to use against our American culture. Americans are taught from early childhood to fear death, that a grave yard is full of ghosts and spirits, a place to avoid at night. The lessons Americans painfully learned in Vietnam can be used here in America to preserve your life saving food, medicine, weapons and supplies. As reported in Quan Doi Nhan Dan (People's Army Newspaper) Vo Nguyen Giap (Minister of National Defense) said in a speech in front of a hospital bombed out by American jets, "Let the innocent dead Vietnamese patriots rise up to take final revenge"

I have included some very high tech burial tubes and some common substitutes that will provide a generation or more of safe storage so those of you who are now pipe dreaming about your survival shelter can **get ready right now** to keep your survival goods safe. I will suggest that you buy your tube from a reputable company like NIC or BEREIT, but you could substitute another "vault" as a possible alternative.

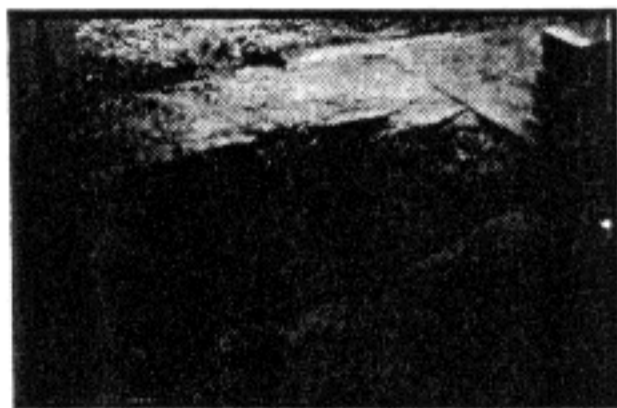

**Top:** A no frills shelter which is uncompleted. This survivalist has found lots of rocks, some as large as a foot locker! He swears he will see it to completion, he lives right in the middle of a large north eastern city.

**Right:** It was common for people to bury their money after the banking collapse in the 1920's. Many farmers who had lost everything buried milk containers filled with their life savings, guns and other goods (Remember gun control started with the 1934 Machinegun Tax).

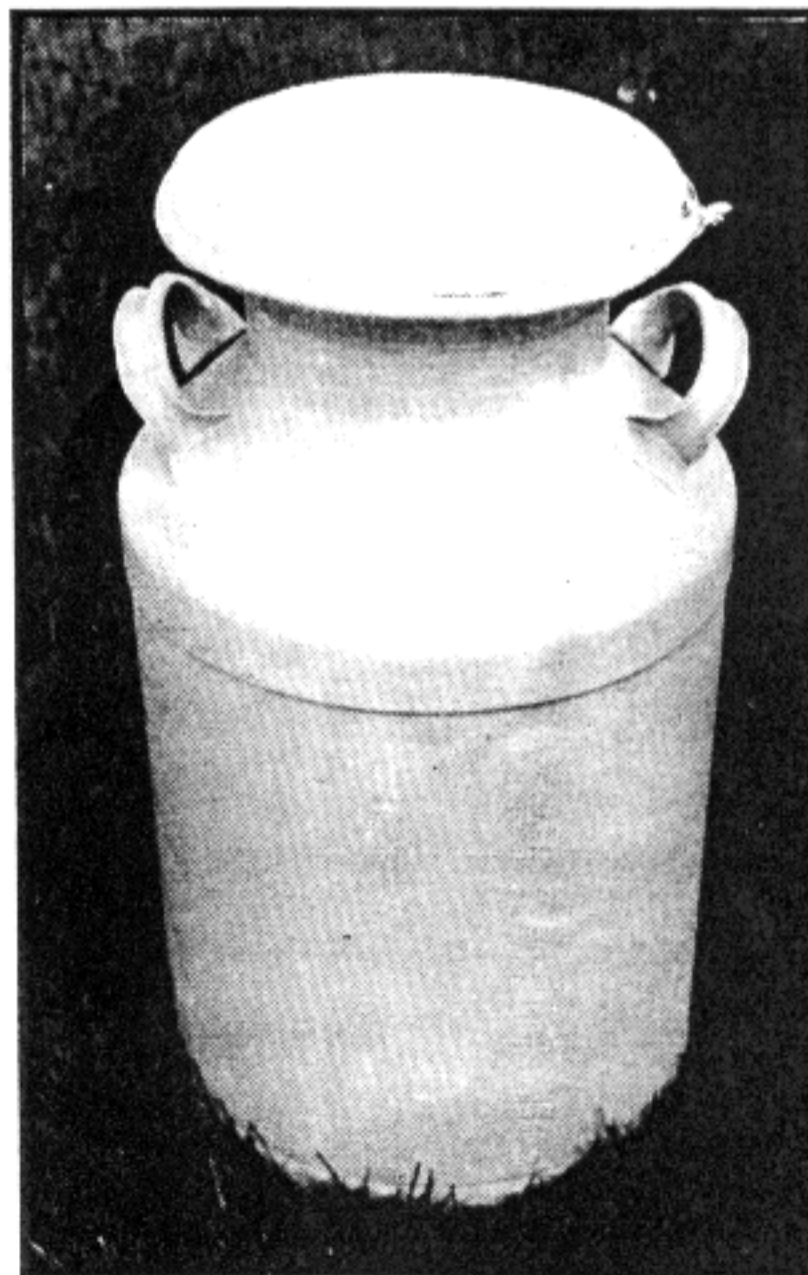

When I first began collecting information on Burial Tubes, I was set back by the "people" selling tubes who didn't advertise their telephone number? The majority didn't even reply to my letters or calls requesting info? There were no delay's at NIC, I called the company's president, detailing my intentions to revise my Shelter manual, well, Alan bent over backwards to get me photos, a sample tube and instructions. In fact the tube arrived in an unbelievable 4 days! NIC's tube utilize a reusable slip fit on end cap that is a super thick, 1/4 inch thick wall tube, 5/16 inch thick wall end caps. This super strong design will allow you to inspect or add to your goods from time to time and easily reseal with silicone. It's biggest advantage is it's large diameter which will easily accommodate 4 AR15's or M16's, 2 AK47's and 2300 rounds of ammo, with plenty of extra room to fit hand guns, money, reloading equipment, radios, night vision, lasers, electronic and optical equipment or anything else you need to safeguard! It is visibly larger and much stronger than the tubes sold by all other suppliers. (most of the other suppliers tubes require that you disassemble many rifles with hand grips or scopes and night vision to fit into the smaller 8" or 6" tube) You clearly get what you pay for with NIC, I guess it all boils down to how much are your possessions worth? and what would your expression be if you dug up your tube 20 years later only to find RUSTY JUNK . Play it totally safe with your irreplaceable survival supplies. NIC's GROUNDHOG VAULT is 58 inches long and 10 inches in diameter! Selling for only \$94.95 plus \$15.00 Shipping & Handling -- Alaska and Hawaii please call for current Shipping charges and deliver times.

## NIC, INC.

PO Box 5950 Shreveport, LA 71135

Phone: 318- 688- -1365



*Bottom: A greater corrosion protection could be obtained by filling your vault with a variety of inert gases, (Most contain no water or oxygen and are commonly available at welding supply stores, for very little money. Here Carbon Dioxide is used with a smaller bottle of Nitrogen on stand by. Also used in soft drink dispensers as corroborators and for welding. This will offer far greater protection for very long term storage, but always use a desiccant to absorb moisture as a back up.*

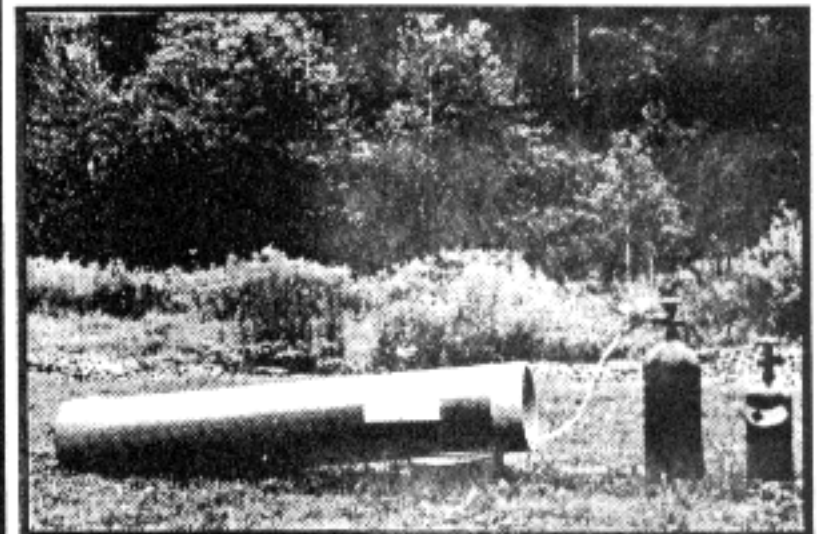



If you are reading this book I'm sure you've already noticed how many people are frightened right now by the present wave of anti-gun hysteria which seems to be sweeping our nation. At no time in our countries history have our freedoms faced such a serious threat. No foreign government could ever hope to subject and enslave the people of this nation, but somehow under the guise of "THE NEWWORLDORDER", our own political officials seem to want to do just that?

BEREIT INDUSTRIES COBRA CASE buryable gun vault will provide many people with piece of mind, knowing that they have the ability to prepare and survive the worst of times, (IF NECESSARY). BEREIT INDUSTRIES super high quality vaults are designed for very long term storage of firearms or any emergency supplies, which YOU can bury, store outside or carry in your vehicle or boat without any regards to water damage. The rifle case model is the most popular version, at 52 inches long it will easily accommodate even the longest rifles and shotguns, and when sealed they are totally water tight. Providing you with over 980 cubic inches of space inside, this case will easily protect up to three rifles with plenty of room left over for other survival necessities. The vaults are fabricated from super heavy duty high grade PVC plastic, with reinforced end caps. Being PVC plastic makes them non-magnetic and their dense heavy duty construction will make your vault "LOOK" like a rock to ground penetrating radar and sonic echo detection devices. Simple but rugged, BEREIT INDUSTRIES had the only reliable "SCREWON" end caps I tested. Easily opened and resealed over and over for you to inspect or to make timely additions as your needs arises. These vaults are delivered complete and ready for you to use the same day your U.P.S. driver arrives with it! Sold at only \$59.95 plus \$12.00 Shipping & Handling. -- Alaska and Hawaii residents please call for current shipping charges and delivery times --

## BEREIT INDUSTRIES

P.O. BOX 130304 Tampa FL 33681

Phone: 813- 832- 3191

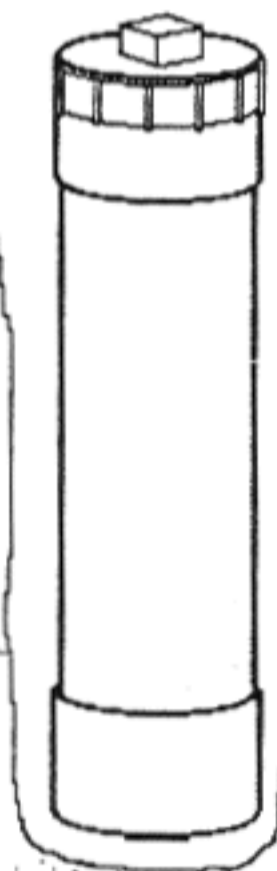

## **IMPORTANCE OF PRE-PLANNING**

Clean your vault as thoroughly as you can, really use a lot of elbow grease with a little clorax to kill the Bactria that will feed on the grease you'll be using to preserve your metal. That's right! the germs will grow and thrive until the environment is totally contaminated with there own waste killing the germs off and leaving a waste filled vault. So rinse and dry the vault thoroughly, you can't have any corrosive detergents or bacterial residue remaining.

If the walls of your plastic barrel are unusually thin and you think they will collapse in time you had better make provisions for some sort of hole bracing or lining in your hole. I don't recommend using the far more common and cheaper 55 gal. steel drums they will rust through in only a few years and are very easy to detect with their strong magnetic signal.

**WHAT TO BURY:** I would bury things you would consider stupid so I won't go into just what to bury but I will suggest ALL GUNS that you bought or inherited without papers, I predict in the future that if the government knows you have guns (they have been tracking them for over 50 years), they will put you in jail until you turn them in. Plan ahead right now!. All the ammo you can get, I mean a shit load. Precious metals or coins that people will recognize, like silver dollars. if you like weapons accessories buy them now, bury whatever you are able to afford in weapons sighting systems, Freeze dried food only, most other foods will only rot, germinating a bacterial waste land, destroying the contents of your tube. Maps and survival books and the supplies to make the "stuff", this chemical knowledge could be a great advantage to your community.

**SEALING;** Is of course vital as any moisture even a minute amount of moisture will rapidly deteriorate your goods, pure high grade silicone sealer should be used in large amounts for sealing, don't skimp here and always test your seal before burial by total immersion in a water tank or swimming pool , any air bubbles will indicate a ineffective seal .

**NO ONE CAN SEE YOU;** Checking for hunting season: so you won't be seen.

**WEATHER;** So everything won't get wet in a rain storm.

**AIR SURVEILLANCE;** They are photographing everywhere looking for those pesky "terrorist marijuana growers". Don't let raw dirt accumulate around the sight, they will be searching for ground disturbance, it's a clear sign that marijuana growers were there. Remember they have been forced to live secret "underground" lives and could be your true friend in the future.

**TOPOGRAPHICALLY LAYOUT:** Don't burry in a swamp or even in seasonally wet areas or flood planes. Go to your local zoning board and request a map of zoning areas like forest and commercial land tracks. Don't bury where there will be future construction.

**BOOBY TRAPS;** It is just plain stupid to plant traps for little kids to find.

**NO TRAILS:** It may take some people days to carry in their goods, so plan a new path each trip,

**BURY DEEP:** At least 2 feet of soil to the top of the vault, 3 feet will be much better.

**STAND THE VAULT UP:** It's far more difficult to detect, and will be passed off as a much smaller "ECHO"

**LOCATION;** Like the old real estate slogan goes Location, Location, Location. If the landscape is changed by logging or other work you will be in deep shit looking for that big oak tree that was cut down ten years ago, so plan your recovery methods completely. My suggestion is to know the spot well, don't go out and dig a little hole in the middle of no where and expect to find it 20 years later, it's not going to happen and if you do find the location, it will be pure luck! Here is my suggestion, pick a land mark that has been there for at least one hundred years and one you expect to be there for another hundred, (grave yards, parks, forest, avoid places where construction is possible) carefully measure the distances and plot your sight. Always check your map by trying to find your sight right after the tube is buried, if everything is OK walk away and don't go back until a few weeks later to check if the ground foliage you replanted has returned, if not plant some more.

**LAST BUT MOST IMPORTANT:** Tell no one, never tell, don't speak of it for life, don't brag even when your drunk never, never, never, don't talk to your self about it, don't tell your wife, your father, your children, your doctor, not even your priest, no one, it does not exist, the end.



## FREEBEE ALTERNATIVES

This country still has a few factories left that may allow you to take away one of these barrels. Keep in mind the workers are in most cases paid slave labor wages and would be glad to help you if they are made to feel they have worth are respected and knowledgeable. You could opt to buy one from companies that supply the food and plastics, paints and chemicals, wire coating and cloth coating, industries etc. New they are \$20 to \$180 for around a 40 gallon sizes. I called for pricing on 8" schedule 35 PVC with 2 caps and priced at \$110.00 the NICs 10" schedule 40 tube or the smaller BEREIT tube looks like a better deal all around.



**LEFT:** This PVC Sealed plastic barrel with a steel retaining band is a very good choice. Holding approx 40 gallons and very durable. This was given to me, it held Teflon and had been cleaned spotless when I received it.



**ABOVE:** Here is a Food grade plastic barrel used to age pickles. The top screws on with a high quality rubber seal. This is a good choice at 42 gallons.

**BELOW:** Another freebee from a Plastics plant worker, it holds 27 gallons and is PVC and very strong indeed. It is returnable for a refill of plastic beads.

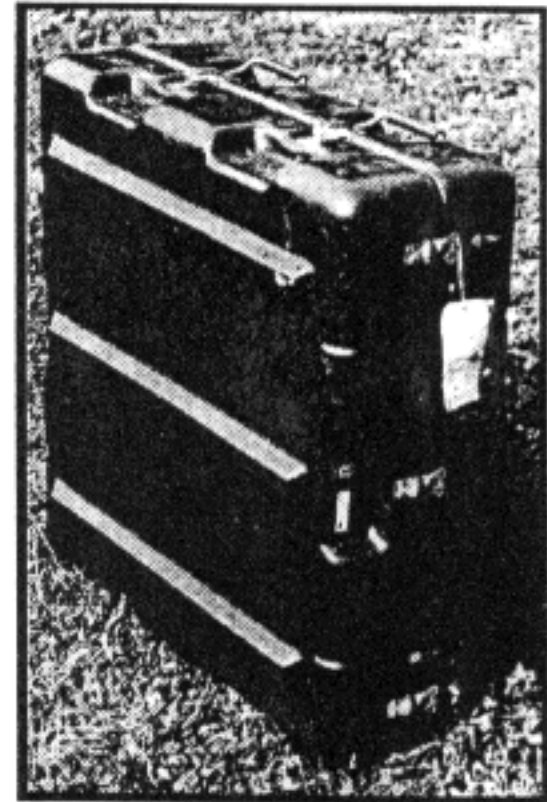
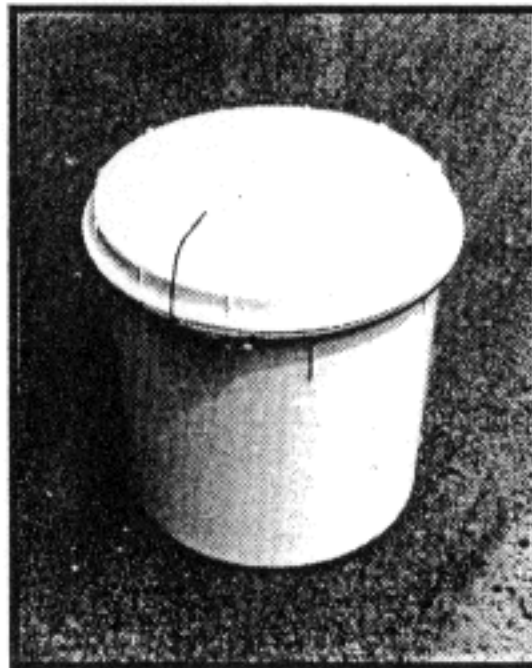

**ABOVE:** Military surplus will provide you with an unlimited choice in size and materials. The one shown above was originally used to protect electronic equipment once, then discarded on the battle field?

**RIGHT:** Ammo boxes are probably the very best vault for the money, they come in sizes up to 8 ft. tall and 2 ft. by 2 ft. square (they hold small rockets) I advise you to treat the outer metal surface with some kind of water repellent like roofing tar or high grade marine paint to stop rust through.



Is it possible to build an underground shelter in your home or garage? In fact I have been sworn to secrecy and shown some very nice shelters, ranging from one in VT costing one hundred thousand dollars which the owner (a public figure) wouldn't even let me bring my camera into, to ones people with more determination and far less money built that do provide very nice semi permanent shelters. One rural N.Y. resident sledged hammered a hole into his garage floor and dug the dirt away until he could fit in a small pull behind camper which he then lowered into the hole and buried, he then re-cemented his garage floor using an ingenious hidden entrance way. This family has the most comfortable shelter I have ever visited, their total cost was less then one thousand dollars for a shelter 7 ft. wide by 19 ft. long. He can shower with spring water and has a septic installed along with city electric with back up batteries and hand generator, heat and hot water, and an Air scrubbing system. Then there are those who just want to bury a small stash, in which case a large ammo can coated on the outside with roofing tar will do nicely. Research the local and federal law books to determine if your actions are in fact legal at the time you carry them out, so I leave you now to investigate the legal ramifications.

*Below: You and I are not the first to bury their guns and supplies! This is being done all around this country and is increasing in popularity. Here a survivalist used a ammo can to safe guard his valuable and irreplaceable survival supplies. They said their can has been buried for over 3 years, they used a aerosol can of liquid grease to preserve the metal.*

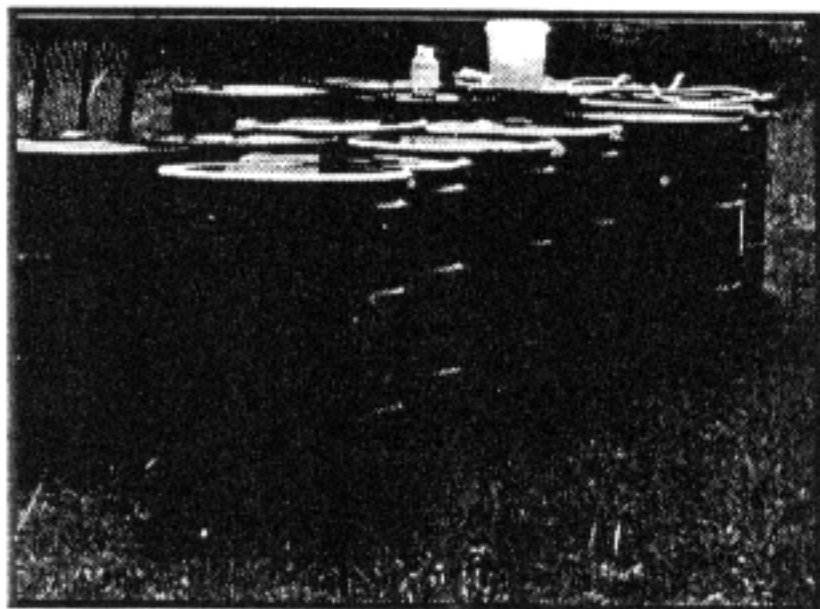
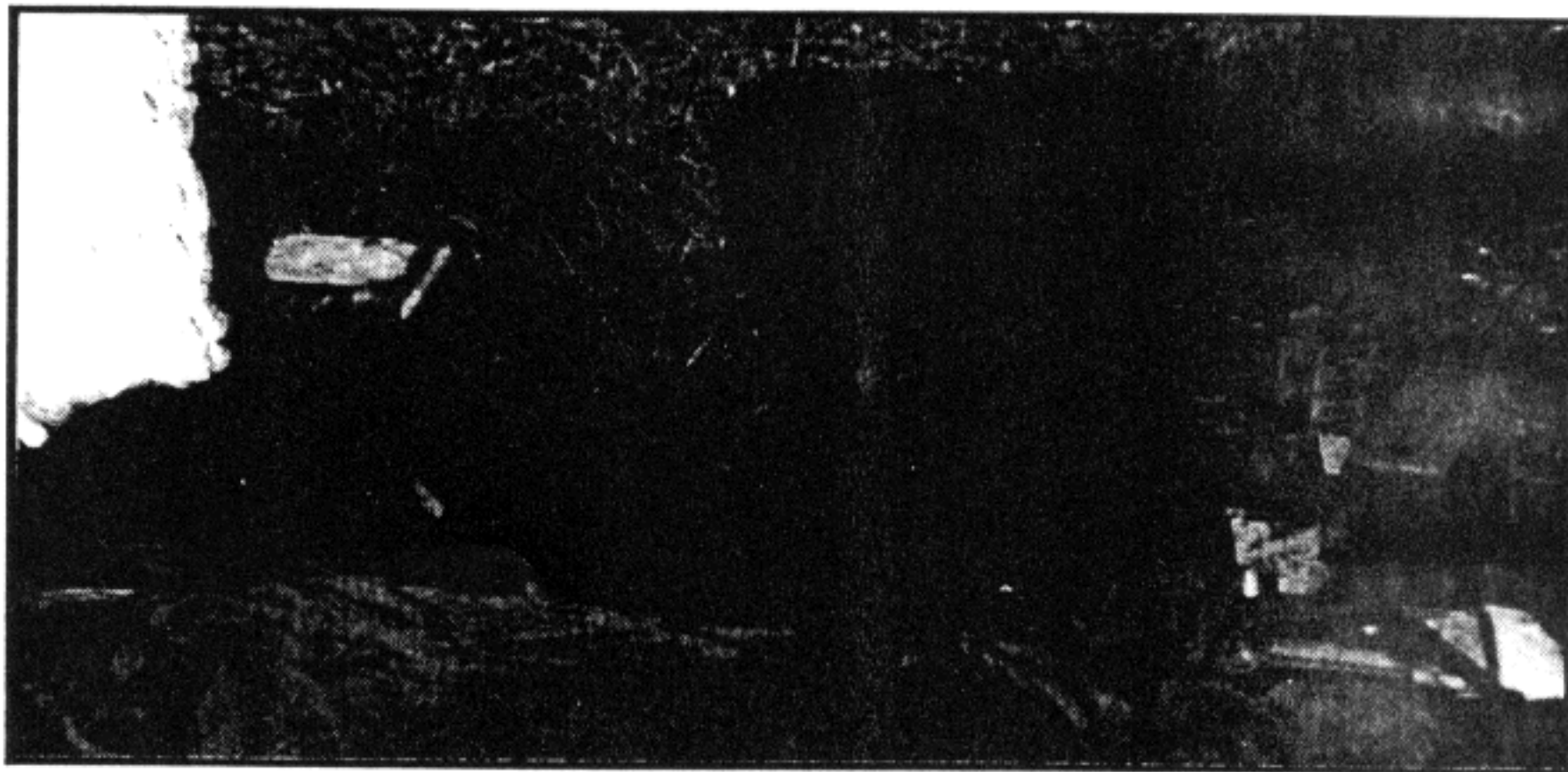

*Left: Steel ring topped barrels are free in most cases, but I would recommend against them, they will rust through in only a few years. A tar coating might help?*

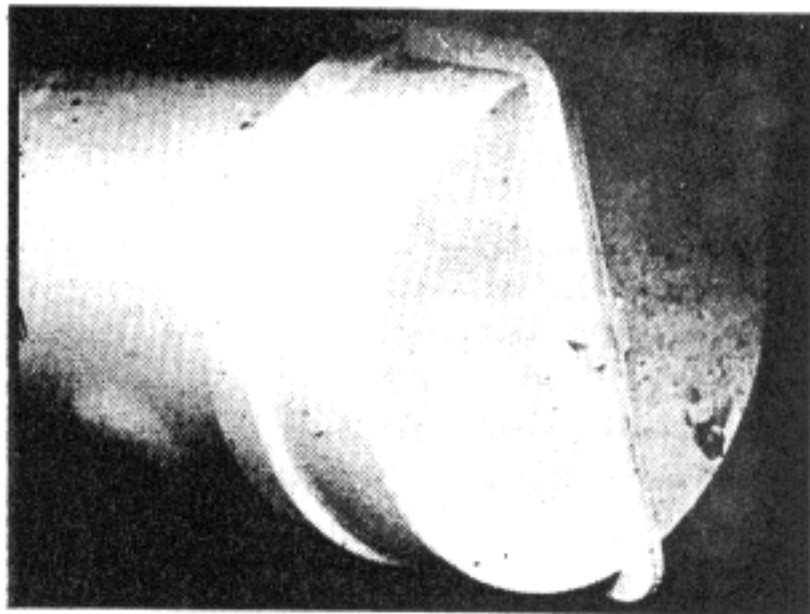

*Right: an 8" PVC tube with a low quality end cap. This cap is designed to be glued onto the tube and cut open when needed. It's low cost is nice but is it long lasting?*