

Trapping Furbearers

An Introduction to Responsible Trapping

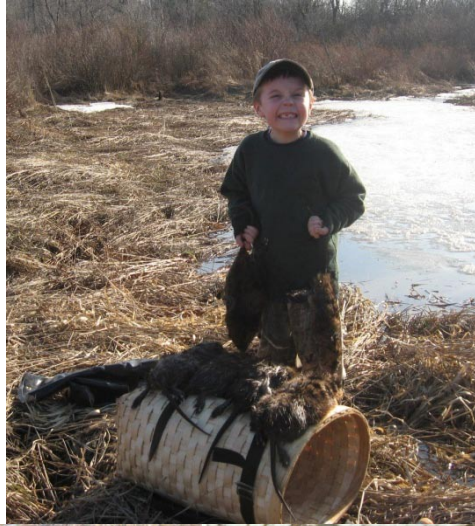

Student Manual

Sportsman Education Program

New York State

Department of Environmental Conservation



Code of Trapping Ethics

1. Know and obey trapping laws and assist in their enforcement by reporting violations.
2. Improve your knowledge of furbearers, their ecology and management, and improved trapping and fur handling methods.
3. Respect landowners' rights and always obtain permission before trapping on private lands.
4. Respect and conserve public lands and the natural resources found on them.
5. Be aware of other people using the outdoors and avoid interference with their activities.
6. Be aware of free-ranging domestic animals and avoid trapping where there is a high risk of catching them.
7. Know and use selective and humane trapping sets with appropriate trap types and sizes.
8. Don't set more traps than YOU can effectively handle.
9. Cover all foothold traps set on land.
10. When trapping muskrat, always use body-gripping traps, guarded foothold traps, or submersion sets.
11. Use body-gripping traps or submersion sets with sliding locks for all beaver and otter sets.
12. Anchor traps securely enough to hold the largest potential catch.
13. Check all traps daily and as early in the day as possible.
14. Dispose of animal carcasses properly.
15. Support trapping, trapper training, and furbearer management and research.
16. Report diseased animals.
17. Make an effort to trap any areas where furbearer populations are overabundant or are creating a nuisance.
18. Know and use proper releasing and killing methods.

Trapping Furbearers

An Introduction to Responsible Trapping

Acknowledgements

A long list of distinguished individuals had a hand in the development of this manual over time. It is based in part on, "Trapping Furbearers – Managing and Using a Renewable Natural Resource", by Dr. Ronald Howard and Dr. John Kelley, published by 4-H/Cooperative Extension at Cornell University. Former and current Department of Environmental Conservation (DEC) staff who participated in the manual's development include Louis Berchielli, Gary Parsons, Mark Brown, Wayne Jones, Paul Bishop, Benjamin Tullar, Robert Henke, David Scudder, and Gordon Batcheller. Critical review of the text was provided by trappers Pete Smith, Tom Hayes, Angie Leubner, Pete Rickard, Gordon Berndt, Tom Fisher, and Ray Schedivy. Al West and Jerry Leggieri provided input on the second edition.

Third edition, printed in 2011. New York State Trappers Association members John Rockwood, Angie Berchielli, and Jerry Leggieri assisted greatly with the creation of this addition as did DEC biologists Scott Smith, Melissa Neely, and Ken Baginski. DEC biologist Andy MacDuff performed editorial duties.

Materials used from other sources for this manual include:

Association of Fish & Wildlife Agencies – logos on page 33 and material in Chapters 5, 7, and 8 and Appendices 1, 2, and 5 (with changes)

Silvertip Productions – Images on pages 5, 6, 15, 16, 17, 80 (top), 81, 99, and 100

Ohio Division of Wildlife – Images on pages 24 (top), 26 (bottom), 30, 37, 38, 76, 79, 80 (bottom), and 85 through 92

Joe Goodman – Images on pages 26(top and middle), 28 (bottom), 29, 74 (all but weasel box), 77 (leaning pole), 103, and 104.

Animal artwork was provided by Wayne Trimm and all other drawings by Michael Stickney.



Funded in part by Federal Aid in Wildlife Restoration Act, project W-125-S, a hunter education project supported by federal excise taxes on hunting equipment.

© Copyright 1997, 2006, 2011. All rights reserved. Material may not be reproduced in any manner without express written permission from the Department of Environmental Conservation.

NYSDEC – Sportsman Education, 625 Broadway, Albany, NY 12233-4800

Trapping Furbearers

An Introduction to Responsible Trapping

Table of Contents

| | |
|--|-----|
| Chapter 1 Introduction | 1 |
| Chapter 2 History of Trapping | 3 |
| Chapter 3 Furbearer Management | 5 |
| Chapter 4 Trapping Laws, Regulations, and Ethics..... | 9 |
| Chapter 5 Trapping Safety and Wildlife Diseases..... | 15 |
| Chapter 6 Equipment and Preparation | 23 |
| Chapter 7 Best Management Practices | 33 |
| Chapter 8 Selective Trapping Techniques | 37 |
| Chapter 9 Natural History of New York Furbearers | 41 |
| Chapter 10 Common Water Sets..... | 67 |
| Chapter 11 Land Sets..... | 73 |
| Chapter 12 Running a Trapline..... | 79 |
| Chapter 13 Fur Handling Equipment, Techniques, and Marketing | 85 |
| Appendix 1 Traps, Sets, & Attractors | 97 |
| Appendix 2 Tracks of New York Furbearers | 99 |
| Appendix 3 Scats of New York Furbearers | 101 |
| Appendix 4 Regulations for Body-Grip Traps Set on Land | 103 |
| Appendix 5 Pelt Preparation | 105 |

Chapter 1 Introduction

You and Trapper Education

Trapping is enjoyable and it provides a variety of benefits to those with the knowledge and ability to do it well. But, if trapping is not done right, it can cause bad feelings towards trappers and trapping. Therefore, trapping is a serious business. The future of trapping depends on the way you as a trapper perform.

Successful completion of a trapper education course is required of all first time trappers in New York State. This requirement started in 1980 to increase awareness of the trapper's responsibilities and to introduce beginning trappers to acceptable trapping methods, ethics and responsibilities, laws and regulations, natural history, and basic wildlife management principles.

All of these things provide a good start for new trappers. Trapping skill, however, must be developed through experience after the course. The things you learn in this course will help make trapping more enjoyable and help make you more successful.

Through this course, you can learn more about the tradition and adventure of trapping, increase your environmental awareness, gain new outdoor skills, and maybe even make some money. In addition, there is the opportunity for personal development through hard work, careful study, and a better understanding of nature and wildlife. It is hoped the course will also encourage beginning trappers to learn more about trapping from personal experience and the experience of others.

You can learn even more about trapping from information you can get from your instructor, your library, the internet, and from local, state, and national trapper organizations.

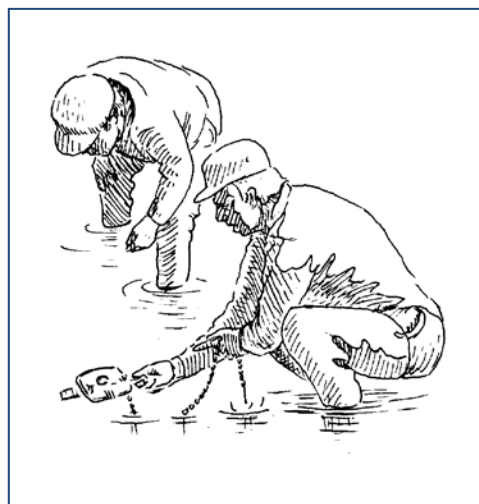

Chapter 2 History of Trapping

Since prehistoric times, human beings have used traps of various kinds to capture animals for food, clothing, or population control. The earliest forms of traps were probably pits, deadfalls or snares. Of these three trap types, only snares, now called cable restraints or cable traps, are still commonly used today.

When Europeans first came to North America, they depended on the plentiful furbearer resources. The demand for fur in Europe, especially beaver, created a large and thriving fur trade in North America from which Native Americans and some of the new immigrants derived a portion of their livelihood.

It was the lure of richer hunting and trapping territories, particularly for beaver, more than the lure of rich soil or even gold that prompted westward exploration and settlement. Along the paths opened by these pioneering trappers, first commerce and then agriculture spread across the nation.

During the 1800s, groups of trappers and explorers known as “mountain men,” many armed



with Newhouse traps, journeyed up the Missouri River to explore the beaver meadows of the Rocky Mountains from Canada to New Mexico. The “golden age of fur” saw native people both befriended and exploited, trappers survived hardships to make or to lose fortunes, and many lives lost all for the sake of fur.

New York State has a rich history in the fur trade. In the mid- 1600s, the area now occupied by Albany, our state capital, was known as Beverwyck in recognition of the volume of fur that flowed through the region. Even today, the official seal of Albany depicts a beaver cutting down a tree, a clear connection to the significant role trapping played in the exploration and development of the Empire State. Also, the Newhouse traps used by the mountain men of the 1800s were manufactured in the Oneida, N.Y. area.

Thanks to sound wildlife management, large populations of furbearers still exist, and many people depend on trapping them to supplement their income. Well-regulated hunting and trapping provide pleasurable and profitable means of using a renewable natural resource without depleting animal populations or reducing opportunities for others to enjoy them.

Chapter 3 Furbearer Management

The Furbearer Resource

New York State is fortunate to have an abundance of furbearers, including muskrat, mink, beaver, otter, opossum, skunk, raccoon, gray fox, red fox, coyote, weasel, fisher, bobcat and marten. These animals have a number of effects upon the environment, economics, and the quality of human life in addition to their fur value. With the exception of beaver and muskrat, most furbearers are predators which are important to maintaining ecological balance in natural systems.

Any discussion of the value of furbearers must consider both their beneficial and harmful effects. Beaver may flood valuable agricultural lands, homes, roadways, woodlands, and in some instances, have detrimental impacts to trout populations. However, their ponds create valuable habitat for animals such as mink, muskrat, and otter and many species of birds. Muskrat eat aquatic vegetation, often opening up portions of marshes creating habitat for fish and wildlife.



However, muskrats can be extremely destructive to the banks and dikes of man-made ponds and lakes. Predatory furbearers, which must kill other animals to eat, may prey on domestic stock, game animals or other valued or rare wildlife. In some areas, coyotes may cause losses of free-ranging stock such as sheep or chickens. Coyotes can play a positive role by controlling mice and other rodents. The corn and songbird depredations of raccoon and skunk must be balanced against their controlling effects on insects and rodents. Another negative concern is that furbearers sometimes carry diseases like rabies and tularemia and parasites like mange mites and ticks.

These are just a few of the tangible positive and negative values of the furbearer resource. The pleasure of seeing and studying these animals is probably the greatest of the intangible values. When both positive and negative aspects are considered, the importance of scientifically based wildlife management becomes apparent.

Wildlife Management Principles

Wise use of abundant natural resources includes the use of a harvestable surplus, coupled with the conservation of the basic resource. The goal of furbearer management is to provide the maximum harvestable surplus consistent with other factors such as habitat quality and availability, disease risks, wildlife damage, reproductive biology and public tolerance for the

species. The best available knowledge of ecology, behavior, current populations and habitat conditions is integrated into management plans using the principles of wildlife management.

Generally, each wildlife population reaches its lowest level just prior to the breeding season, regardless of whether it was harvested by people or not. The remaining individuals breed and once again produce offspring. It is because of this ability of living things to rebound from annual reductions that they are often referred to as “renewable resources.” Non-renewable resources, such as coal, oil, and other minerals, are present only in limited quantities.

Within certain limits, all of the living components of the natural resource base are renewable. Forage plants and wildlife are renewable. Entire communities are dynamic and renewable as long as their requirements for life and reproduction are met.

Every organism has a set of required resources (food, cover, shelter, and space) which must be supplied by its environment. Each required resource exists in some limited amount. Any resource that exists in an inadequate amount is called a limiting factor, because it limits the population of the organism in that time and place. For example, a marsh may have enough food, cover, shelter, and space to support 1,000 muskrat during the spring, summer, and fall. During the winter months, the food supply may only support 300 muskrat. Though the cover, shelter, and space are sufficient, the remaining 700 muskrat must either avoid the food shortage by moving elsewhere or die.

The entire set of required resources determines the carrying capacity of a particular area for each species. The carrying capacity is the number of animals a habitat can support at any point in time. Carrying capacity is similar to the volume of a bucket. When the bucket has been filled, adding more to it only wastes what is added. Sometimes the best management plan dictates that a population be held below its carrying capacity for some reason, such as when a species is causing excessive damage. Management attempts to achieve levels above the carrying capacity of the habitat are invitations to environmental problems and resource waste. All living things, including human beings, share the limitations of carrying capacity.

Most organisms produce more offspring than the habitat can support. The excess individuals are lost through predation, starvation, disease, or some other means. Loss rates are quite high in most organisms. Muskrats, for example, frequently lose 70 percent of their population from one breeding season to the next. This attrition (loss) rate is found whether humans influence it or not. Increases in mortality caused by one factor, such as predation, are often compensated by decreases in other factors, such as starvation or disease. Thus, the total loss rate remains fairly constant.

Wildlife cannot be stockpiled; it is a dynamic resource with high and low populations each year. Surplus animals



die until the habitat that they occupy is able to support the survivors. Each year's wildlife population consists of two parts: capital stock and surplus stock. Capital stock is that portion of the population that the habitat can support. Surplus stock is the portion the habitat cannot support. Surplus stock will die by some means before the next year's young are produced. Use of the surplus provides recreation, products, food and employment without depleting the capital stock. The capital stock that remains produces another surplus and provides the other wildlife benefits that many consider essential.

If the resource is to be maintained for the use and enjoyment of future generations, management decisions cannot be based on whim, political expediency, or emotion. In some instances, such as disease epidemics, good management dictates drastic reductions in populations. In others, such as the management of endangered species, complete protection is the best management plan.

The Rationale for Trapping

Furbearers are a part of the wildlife resource. The harvest of surplus furbearing animals results mainly in the production of durable, warm and beautiful fur clothing. Recent criticisms of trapping and the fur industry have implied vanity demands furs instead of readily available synthetic fibers. Beauty is only part of the usefulness of fur. One of its greatest advantages is the renewability of the resource and the relatively low fossil fuel cost of its production. Synthetic fibers come either from nonrenewable resources (coal or petroleum) or from energy intensive resources (wood-fiber). Most of the energy involved in the production of fur garments is biological energy, the energy of growth and of human labor. As a result, fur garments have a lower carbon footprint than their synthetic counterparts.

Sound furbearer management can attain the double goal of wisely using surplus stocks while preserving capital stocks for future productivity and use. Harvesting wisely, legally, efficiently, selectively, and humanely, trappers can manage for a continued yield of furbearers, and ensure the resource is preserved for future generations. In that way, benefits of both consumptive and non-consumptive use of the resource can be realized.

Use the Right Trap for the Situation

Before placing the first trap, a trapper should learn all he or she can about trapping and furbearers. A responsible trapper uses selective sets and minimizes the time a trapped animal is held. Trappers have spent a great deal of time designing and improving traps and types of sets that will kill their catch as quickly and humanely as possible and designing restraining traps and systems that hold animals alive with a minimum or no injuries. Responsible trappers carefully select the appropriate trap for the situation.

Body-gripping traps, which are designed to kill the trapped animal relatively quickly, do not always do so and are not adaptable to all types of furbearers or all types of sets. No responsible trapper will use a body-gripping trap where it is possible to catch animals such as protected wildlife, domestic stock, or house pets.

Box traps, including cage-like wire traps which catch only one animal at a time, are appropriate and effective in some trapping situations, although not for fox or coyote. They seldom harm their catch and make it possible to easily release unintended catches. They are excellent choices for areas where domestic animals or other unintended species are frequently encountered, such as in urban or suburban areas when trapping problem raccoons, skunks, and opossums.

Foothold traps (steel traps) are the primary type of trap used. Animals taken in these are commonly caught by the foot. When properly set and of appropriate size, the major effect of the trap lies with restricting the animal's movements. Some animals resist being so restricted; others may lie down and even sleep. Unwanted animals can usually be released. Desired animals are killed by the trapper as quickly and humanely as possible. When trapping semi-aquatic animals, sets are made so that the animal is quickly submerged and killed through asphyxiation.

Enclosed foothold or foot-encapsulating traps are a recent design that trappers developed to increase trapping selectivity. Designed primarily for trapping raccoon (although they will also capture skunks and opossums), these traps employ a small diameter opening and pull-type trigger, making them virtually dog-proof. The use of these species-specific devices has allowed trappers to operate in areas that were previously avoided because of concerns about capturing domestic stock and pets.

By law, trappers must visit their traps at least once in every 24-hour period (48 hours in some areas).

Chapter 4 Trapping Laws, Regulations, and Ethics

Trapping Laws and Regulations

Conservation laws are designed to ensure a continuing population of furbearers and to establish ethical standards for trapping. They also aid in permitting all citizens to share the common resource. Usually, open seasons are set to include the period when the fur is at its best or “prime.” Both the regulations on trapping and the open season for various species of furbearers



are listed in the annual “Hunting & Trapping Regulations Guide” and on the Department of Environmental Conservation website at www.dec.ny.gov. The guide booklets are available wherever licenses are sold. Regulations and season dates sometimes change, so trappers should review the “Hunting & Trapping Regulations Guide” before hitting the trap line each year. When in doubt about some point on seasons or regulations, check with your local Environmental Conservation Officer or call your nearest Regional Wildlife Office and speak to a biologist familiar with trapping.

Key points to remember:

- The law requires you to visit your traps at least once in every 24-hour period (48 hours in some areas) and to tag all traps clearly with your name and address or your license ID number.
- You are required to carry your trapping license with you when you are trapping.
- You must comply with all licensing and tagging regulations.
- The law specifically prohibits disturbing lawfully placed traps or removing lawfully trapped animals from the traps of another person.
- Trappers should avoid harming domestic animals.

Trappers must be familiar with many other laws, such as those protecting landowners and their property. Securing the permission of landowners before setting traps is the trapper’s responsibility. Trappers must also be familiar with laws protecting certain species of wildlife, and must use their expertise to reduce the risk of taking these protected species. All trappers must adhere strictly to all laws and recognize their responsibilities to ensure the continued wise use of the resource.

Trapping Ethics

The use of a public resource demands that you exercise both courtesy and personal responsibility. Respect for oneself, landowners, other people, the furbearer resource, and habitat summarizes this expression of that courtesy and responsibility. It is delineated in a personal code of ethics that goes beyond legal requirements and is set forth on the inside cover of this manual. It is your responsibility to adhere to this code. Remember that you may be the only trapper the public may come in contact with. You should act in a way that will reflect positively on all trappers.

Trappers must know and obey trapping laws and be willing to report violations of these laws to their local Environmental Conservation Officer or to the Turn in Poachers and Polluters line at 1-800-TIPP-DEC. Failure to do so may result in increased public criticism of trapping and possible limitations in opportunities for all trappers.

Responsible Trapping

The proper use of legal traps will help deflect public criticism of trapping. Using the proper size and type of trap for the intended species minimizes or eliminates injuries to the trapped animal. Using selective sets and baits at the proper locations reduces the chances of catching unwanted animals. Securing a trap in a manner to hold any animal captured eliminates the possibility of animals escaping with the trap still attached. An empty or bent trap is better than an animal escaping with the trap.

Cover all foothold traps set on land. This will actually increase your catch and reduce any damage caused to the animal.

Check traps daily and as early in the day as possible to minimize the time an animal spends in the trap. This in turn reduces the likelihood of physical damage and stress to the captured animal and decreases the chance of escape.

When trapping in the water for semi-aquatic species, all traps should be placed in a manner that will submerge the captured animal. This causes a quick and humane death. Setting the trap in the water also reduces the likelihood of catching unintended animals. When trapping muskrats, using guarded foothold traps or small body-gripping traps is necessary wherever there is

a possibility that the trapped muskrat will not stay submerged. Often, set locations for muskrats are found in shallow or heavily vegetated water areas where there is either insufficient depth to



submerge the animal or the trap and anchoring system may become entangled before the animal is submerged.

Considering the activities of others, whether they are hunting, watching birds, or harvesting crops, is an essential part of the trapping ethic. A good trapper is a good citizen who respects the rights and property of others. A trapping license does not entitle the trapper to free access to private land. Get permission to trap on private land. Remember not to cut stakes, drive on farm lands or set traps in standing crops such as corn without specific permission from the landowner. A trapper can cultivate a landowner's goodwill by offering to legally trap nuisance animals, such as muskrats burrowing through dikes.

Avoid Trapping Unintended Species

Be responsible by not setting in areas where there is a risk of capturing a cat or dog. If a domestic animal is captured, immediately release it and if at all possible inform its owner, especially if any injuries have occurred.

Trapping in urban, suburban and rural areas where there are free-roaming pets requires extreme caution. Trap sets which may be quite selective as far as wild animals are concerned will sometimes catch a dog or cat. Your best option is to not trap in such areas. Padded jaw traps are another option when land trapping for foxes or coyotes where pets are afield. The use of body-gripping traps in areas where dogs and cats are afield is strongly discouraged. Overall, the best option when there is a strong chance of catching a domestic animal is to not trap in that location.

Do not use exposed carcasses or parts of animals, meat, or fish as bait. These can attract raptors (birds of prey) and may lead to your catching one of these protected birds. Since raptors hunt by sight, covering bait so that it cannot be seen from above will help avoid problems and is currently required by regulation for any set made with a foothold trap.

A good general rule for humane trapping is to always use the smallest size trap available that will catch and hold the intended furbearer effectively. Most land furbearers in New York State can be effectively trapped with traps no larger than a #1 ½ coil spring. Larger traps can cause greater and unnecessary damage, especially to smaller animals.

A New York State law (developed jointly by the Department of Environmental Conservation and the New York State Trappers Association) requires that trappers use pan tension devices on all foothold traps over four inches wide set on land. All such traps must also be covered. Trappers can either bring pan covers or use natural materials such as leaves and soil.

The pan tension of some traps (e.g., some coil spring traps) is adjustable and can help you avoid catching smaller animals. Accessory devices are available for adding this capability to other kinds of traps. The ability to adjust the pan tension of a trap can be a very important factor in reducing unintended catches. If you are trapping for foxes and raccoons, for example, adjusting your pan tensions so that between 1 and 2 pounds of force are required to depress the pan and fire the trap will substantially reduce the likelihood of catching birds and smaller animals.

Trap Hardware

Several recommendations regarding trap hardware can be made. These are not critical for traps used in submersion sets, but it makes sense to have all of your traps set up the same way so they can be used for any type set. To ensure that the trap will turn with the animal, there should be one swivel at the trap end and one at the stake end of the trap chain, at a minimum. Both swivels should be in good working order.

The trap chain should be as short as it can be and still allow enough freedom to make the set. The chain swivel should be attached to the trap as close to the center of the trap frame as possible rather than at the point where the jaws pivot on a coil spring trap or at the end of the spring on a long spring trap. This also helps ensure that the trap can turn with the animal. For larger animals such as coyote, trappers may want to add shock springs into their chain systems to minimize the stress the animal can place on the chain.

Finally, the addition of extra springs to traps is not recommended. This can contribute to excessive or unnecessary damage to the trapped animal. The mechanical advantage of the trap design is usually more important than the speed with which the jaws close for catching and holding animals.

The use of drags is not recommended. They can cause a trapped animal to be seriously injured or to be lost. Every trap should be anchored firmly enough to hold any animal that could be caught. You do not want an animal escaping with your trap attached to it.

Cover all foothold traps set on land with a layer of sifted dirt or other covering. This will increase your catch and it is required by law in some cases. Check your traps daily and as early in the day as possible to minimize the time an animal spends in the trap to help reduce damage, stress and the chance of a pullout.

Keep Yourself Up to Date

Completion of a trapper training course does not mean that you are an accomplished trapper who knows all there is to know. A good trapper realizes this and is always willing to learn. New traps and trapping techniques are constantly being developed. Trapping organizations, magazines, and new books can provide advice. Attending one of the frequently held trapper conventions in New York or elsewhere is an excellent way to learn from seasoned expert trappers. A good trapper stays up to date with these changes in order to be as humane, selective, and effective as possible. Keeping yourself current is your responsibility.

A good trapper respects the resource being used. Respect in this instance includes making full use of the animal once removed from the wild. Proper pelt preparation ensures that the fur will not be wasted. Some carcasses can be used for food, dog food, or in lure preparation. Game cookbooks have recipes for delicious meals from furbearers. As long as you have the meat and it is properly handled, why not try dishes like “broiled marsh rabbit” (really muskrat) or beaver stew? When the carcass cannot be used, dispose of it in a manner which will not offend other people, such as burial or composting (see <http://cwmi.css.cornell.edu/composting.htm> for information on how to compost animals).

The trap sets and other information in this manual are presented to guide you in becoming a good trapper. Over the years, these sets have proven to be the most selective and humane. The tools of trappers are important, but the proper use of these tools is what will make you become a responsible trapper. You have a choice; you can support trapping and the future of the resource by abiding by both the law and the standards set for an ethical trapper, or you can ignore this information and risk harming the furbearer resource and reducing trapping opportunities for all trappers. Let’s work together for the future of trapping and our valuable furbearing animals.

Success in Trapping

Some beginning trappers think that a successful trapper catches a furbearer in almost every trap, every night, which just doesn’t happen. Many professional trappers average only one fox for each twenty traps checked. A trapper’s catch depends on many things such as the area trapped, weather and furbearer populations. Success results from a combination of skill, experience, proper equipment, thorough scouting, properly set traps and confidence in your equipment and methods. Trappers should not be judged by their catch volume but rather by how ethical and responsible they are. An important part of that responsibility is to continue checking traps as long as they are set even when a large volume of animals may not be caught.

Chapter 5 Trapping Safety and Wildlife Diseases

Trapping is not a dangerous activity, but there are risks related to weather, drowning, animal bites, and disease. Develop safe attitudes and make safe behavior a habit.

Hypothermia

Hypothermia is a leading cause of death among people who enjoy outdoor recreation. Cold and wet weather, wind, and falls in water can lead to a loss of body heat. When your body temperature starts to fall, hypothermia sets in and it can happen very quickly.

Shivering is one of the first signs of hypothermia. If this happens, go to a warm place, put on warm and dry clothes, or build a fire. Soon after shivering starts, a hypothermic person may become confused and clumsy. Watch for signs of hypothermia whenever you are outdoors in cooler weather. Even when air temperatures are in the 50s, hypothermia can occur.

Trappers can prevent hypothermia by wearing warm, layered clothing. Wool clothes are a good choice because wool insulates even if it becomes wet. Several modern fabrics would also be good choices as they can be lighter, faster drying, and waterproof. Use hip boots or waders, plus long-sleeved rubber gloves when trapping in water. If you get wet, return to home, camp or your vehicle, and put on dry clothes.

Frostbite

Frostbite occurs when ice crystals form in your body's cells. It is a common cold weather injury to people's cheeks, ears, nose, toes, and fingers. Frostbite symptoms include white to grayish-yellow skin and an intense cold, numb feeling. Pain and blisters may also be present. Protect frostbitten skin from further injury. Drink warm fluids, put on more clothes, or wrap up in blankets. The frozen area can be soaked in warm, not hot, water (102 to 105 degrees F). Never rub frostbitten skin because rubbing will cause further injury.

Trapping on Ice-covered Lakes, Ponds, Rivers, and Streams



Avoid traveling on ice-covered streams and rivers. Water currents can cause weak, dangerous ice. Ice on a pond or lake is usually more consistent, but you should still be cautious. Springs, underwater structures, and objects above the ice surface that gather heat from the sun (for example, logs, beaver lodges and dams) can cause weak spots in the ice on lakes and ponds.

Newly formed clear ice is generally the strongest. Some trappers consider three inches of ice to be the minimum thickness needed for one person to safely cross, but four inches is better. Six inches or more of strong ice is required for multiple people or snowmobiles.

White ice, or ice mixed with snow and slush, is weaker than clear ice. Candle ice (deteriorating columnar or grainy ice), usually found in the early spring, occurs when good ice starts to decompose. Candle ice may be unsafe, even if it is two feet thick. Ice cleats can help you maintain a safe footing. Carry a walking staff to help check for ice conditions in front of you as you travel.

Many trappers carry ice safety picks while working their traplines. Ice safety picks have strong handles with short spikes in the ends. The handles are tied together with rope. Thread the rope and picks through the sleeves and back of your coat so you will have them handy if you fall through. It is difficult to pull yourself out of the water without ice picks.

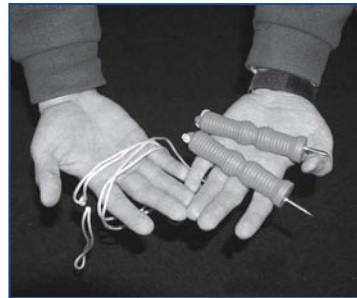

If you do fall through the ice try to climb out by facing the direction you came from when the ice gave way. When you get out, roll in the direction you came from when you fell through. The ice may be even weaker if you try to go a different direction.

If a companion falls through, lie down on the ice to distribute your weight. Reach out to the victim with a walking staff or throw them a rope. If you approach too close you may fall in too.

After escaping from icy water build a fire immediately unless you are close to shelter or a vehicle where you can get warm. After falling into icy water, hypothermia will set in quickly. If you have a cell phone with you, call for help immediately.

Drowning

Trappers need to be aware of the danger of drowning. It is easy to slip and fall down a steep bank or slip into deep water holes of rivers and streams when wading. It is difficult to swim when wearing waders or hip boots or when your coat pockets are filled with heavy gear.

It is a good idea to wear an inflatable personal flotation device when trapping around water. Good ones have a gas canister that can be used to inflate the vest instantly if you need it. The vest should also have a tube you can use to inflate it by mouth if the gas canister fails.

When wading, it is best to travel upstream because the water depth generally increases gradually. You are more likely to encounter steep drop-offs caused by currents when walking downstream.

Use a walking staff when wading to probe the water depth and bottom conditions. Smooth rocks or debris in the water can cause you to slip. You may encounter soft bottoms or hazardous

conditions at points where two streams come together. A walking staff can also help you maintain your balance on other slippery surfaces like ice. When crossing streams, use a walking staff, move slowly and face into the stream current.

If you use a canoe or a boat for trapping follow all safety rules. Consider taking a boating safety education course to improve your knowledge and skills. When using a boat always wear a personal flotation device (PFD). Not only is it the smart thing to do but at certain times of the year it is the law.

Wildlife Diseases

Wild animals can carry a number of infectious diseases that can cause human illness. Some diseases are specific to one or a few species of furbearers, while other diseases affect many species of wildlife. Wildlife diseases transmittable to humans or domestic pets should be of concern to anyone who regularly encounters or handles wildlife.

Infectious diseases can be caused by numerous organisms and may spread by direct and/or indirect contact with infected animals. Trappers can also be exposed to parasites associated with wild animals. Follow the recommended precautions to protect yourself from potential hazards. If you become ill make certain your doctor is aware of your trapping activity.

General precautions include:

- Wear latex or other protective gloves, eye protection, and protective coveralls when handling carcasses or scat.
- Wash hands and arms thoroughly with soap and water after handling animals.
- Clean and disinfect knives, skinning boards, cutting surfaces, and other equipment with a bleach solution of 1 part bleach in 9 parts water.
- Avoid sick animals or ones that do not act normal.
- Do not drink untreated water from lakes or streams.
- Cook all wild game thoroughly.



Animal diseases and parasites that may affect humans include:

Rabies - Rabies is a virus that infects the central nervous system. Left untreated, rabies is always fatal. The rabies virus may be carried by all warm blooded mammals but it occurs most often among wildlife species such as raccoons, bats, skunks and foxes. Rabies is usually transmitted by

the bite or scratch of an infected animal. Rabies can also be transmitted by contamination of a cut or scratch when skinning an infected animal, or from contact with your eyes, nose, or mouth.

Rabies occurs in two forms in wildlife; “dumb” and “furious”. In the dumb form the animal is lethargic and may suffer paralysis. In the furious form the animal is restless, aggressive, and may bite at real or imaginary objects.

If you are bitten by a wild animal wash the bite with soap and water, then seek medical attention. If possible, capture or kill the animal without damaging the head. Health authorities will test the brain tissue for rabies. Keep the animal refrigerated at 35 to 40 degrees F until it can be examined. Human Diploid Cell Vaccine (HDCV) can offer protection from the rabies virus without serious side effects. Ask your doctor for advice about HDCV, especially if you are trapping in areas where animals are known to carry rabies.

West Nile Virus - Most people who are infected with the West Nile virus will not have any type of symptoms. About 20% of people who become infected will develop West Nile fever. Symptoms include fever, headache, tiredness, and body aches. There may be a skin rash on the trunk of the body and swollen lymph glands.

The symptoms of severe infection (West Nile encephalitis or meningitis) include headache, high fever, neck stiffness, stupor, disorientation, coma, tremors, convulsions, muscle weakness, and paralysis. It is estimated that approximately 1 in 150 persons infected with the West Nile virus will develop a more severe form of disease. The incubation period is 3 to 14 days, and most West Nile fever symptoms last for a few days. Severe infection symptoms may last several weeks. Neurological symptoms or damage may be permanent.

It is best to prevent the West Nile virus by avoiding mosquito bites. Stay out of the field from dusk to dawn during mosquito season. Wear long sleeve shirts, long pants, and socks when outdoors. Use a mosquito repellent containing DEET on exposed skin. The Center for Disease Control advises that you should not use DEET repellent on skin under your clothes. Do not apply repellents containing permethrin directly to your skin.

Tularemia - Tularemia is a bacterial disease most commonly associated with rabbits and hares. Beavers and muskrats may also carry this disease.

Tularemia is most commonly transmitted by the bite of blood sucking ticks or fleas. The bacteria enter the body, multiply, and invade internal organs. The liver and spleen enlarge and become covered with white spots. Humans can get tularemia from skinning infected animals, drinking contaminated water, being bitten by infected deer flies and ticks, and sometimes by eating undercooked meat. Symptoms include fever, infected sores, swollen lymph nodes and flu-like feelings. These symptoms may become severe. With prompt antibiotic treatment, few cases of tularemia are fatal.

Lyme Disease - Lyme disease is a bacterial infection spread by the bite of a deer tick (*Ixodes dammini*). When diagnosed early the disease can be treated with antibiotics.

People get Lyme disease when they are bitten by ticks carrying *Borrelia burgdorferi* bacteria. Ticks that carry Lyme disease are very small and can be hard to see. If these tiny ticks bite mice infected with Lyme disease and then bite people or other animals the disease can be passed on. After several days or weeks the bacteria may spread throughout the body of an infected person.

Diagnosis is difficult since Lyme disease symptoms vary and are similar to other common illnesses. One of the first symptoms may be a red circular skin lesion, but often the rash will not appear. Other early symptoms are flu-like and may include weakness, headaches, nausea, fever, stiff neck, dizziness, muscle aches, sore throat, and swollen glands. In advanced stages more serious symptoms may occur including facial paralysis, arthritis, and heart problems. Consult your physician if you have symptoms of Lyme disease.

Prevent Lyme disease by preventing tick bites. Use a repellent containing DEET on exposed skin. The Center for Disease Control advises that you should not use DEET repellent on skin under your clothes. Do not apply repellents containing permethrin directly to your skin. Wear light colored clothing when walking in tick habitat. Wear long sleeves and long pants. Check yourself thoroughly for ticks. If bitten by a tick remove it promptly and disinfect the bite with rubbing alcohol.

Leptospirosis - Leptospirosis is a bacterial disease that infects humans and animals. Almost all mammals can be infected, but it is more common in domestic animals than wildlife. The disease is known to infect striped skunks, raccoons, foxes, opossums, bobcats, muskrats and woodchucks. Leptospirosis spreads from eating infected food, contact with the urine of an infected animal, or contact with urine-contaminated water. The bacteria may enter the body through skin wounds, mucous membranes, or cuts. Leptospirosis bacteria multiply in the blood stream and may affect the kidneys. The bacteria leaves the body in the urine. Infection can cause flu-like symptoms in humans including headache, fever, muscle ache, vomiting, and kidney damage. Antibiotics are very effective for treatment.

Sarcoptic Mange - Mange is caused by a parasitic mite. It occurs throughout North America and is most commonly found among red fox, coyotes, and domestic dogs. Adult female mites burrow under the skin and deposit their eggs. This causes the animal to scratch, chew, or lick the infected area, which leads to inflammation and infection. When the eggs hatch the condition worsens. The animal's hair falls out. The skin thickens, and gets crusted with scabs, and cracks. Mange is always fatal to red foxes and sometimes to coyotes. The mite is transmitted among animals through direct contact or by contact with contaminated areas such as dens or burrows. People can get the mites by handling mange infested foxes, coyotes, or domestic dogs.

Trichinosis - Trichinosis is caused by eating raw or undercooked pork and wild game infected with a roundworm parasite called trichinella. It affects people and many kinds of domestic and wild animals. The parasite forms cysts in muscle tissue.

Cook furbearer meat thoroughly until the juices run clear. Freezing game meat, even for long periods, may not kill all worms. Likewise, curing (salting), drying, smoking, or microwaving meat does not consistently kill infective worms.

Giardiasis - Giardiasis is caused by a parasite that can be carried by many animals, including beaver. Beaver do not appear to be severely affected by the disease, but infected beavers can contaminate water sources used by people. Giardiasis spreads from drinking contaminated water or eating contaminated food. Human symptoms include diarrhea, cramping, weakness, and mild fever. The condition can last 1-2 weeks. Medication is usually prescribed to treat this ailment.

Raccoon Roundworms - *Baylisascaris procyonis* is a common intestinal roundworm parasite found in raccoons and can cause a fatal nervous system disease in wild animals. The worms develop to maturity in the raccoon intestine, where they produce millions of eggs that are passed on with the feces. Released eggs take 2-4 weeks to become infective to other animals and humans. The eggs can survive for years. Most raccoons in New York, especially young of the year, have raccoon roundworm infections.

Raccoons tend to defecate in specific places over a period of time. Likely places are at the base of trees, barn lofts, sand boxes, chimneys, attics, or on high surfaces such as rocks or roofs. People become infected when they accidentally ingest the eggs. The eggs can become airborne as dust particles and people can inhale them. When humans eat or inhale raccoon roundworm eggs, they hatch into larvae in the person's intestine and travel through the body, affecting the organs and muscles. Severity depends on how many eggs are ingested and where in the body the larvae spread. Symptoms can include nausea, tiredness, loss of coordination, and blindness. Infected animals may show signs similar to rabies.

Tapeworms and Other Parasites - People can get tapeworms and other parasites from contact with furbearer or dog feces. Keep your hands clean to prevent accidental ingestion of the microscopic eggs. *Echinococcus granulosus* has been confirmed in New York and its eggs may be found on the fur and in the feces of coyotes. Trappers should wear gloves when handling coyotes and wash their hands thoroughly after handling coyotes or their pelts.

Other Viral Diseases - Pseudorabies, parvovirus, and distemper are diseases that can be carried by furbearers and passed on to pets or livestock. Have your pets vaccinated and seek treatment for them if you suspect these diseases.

Trappers desiring additional information on animal diseases and parasites should speak to their physician or search the New York State Department of Health website at www.health.state.ny.us/diseases/.

Animal Bites and Scratches

Animal bites and scratches can cause serious injuries. Wash wounds thoroughly with soap and water, apply bandages, and seek medical assistance. Keep the animal confined for observation if possible. If you can't confine the animal, kill it without damaging the head so that health authorities can test it for rabies. If bitten, report the incident immediately to your local County Health Department.

See the chapter on "Running a Trapline" for information on safe ways to release animals from traps to prevent bites and scratches.

Be Safe, Be Seen

Trapping seasons usually coincide with hunting seasons for several species of game animals. Trappers should make themselves visible to hunters by wearing hunter orange, or another highly visible color, article of clothing. Something as simple as a hunter orange vest or cap will suffice and greatly reduce the chance that a hunter may misidentify the trapper as a game animal. Wearing hunter orange clothing will also make it easier to find you if you are lost, injured, or sick.

Setting Large Body-Gripping Traps

Some traps, such as large body-gripping traps used for beaver, can be dangerous to a trapper who doesn't know how to use them properly. If you are accidentally caught in a large trap you need to know how to release yourself, which may be difficult if you can't use one of your arms. Large body-gripping traps are most often set underwater. You can drown or die from hypothermia if you get caught in a large trap set underwater.

When using large body-gripping traps carry setting tongs and a length of rope with a loop in the end at all times. Keep the rope in a pocket or around your waist where you can easily reach it with either hand. If you are caught, thread the rope through the ends of the springs. Put your foot in the loop and use your free arm to pull the loose end. This releases the pressure on the springs so you can free yourself.

Firearms Safety

Many trappers carry firearms to shoot animals caught in traps. Take a hunter education course to learn about firearm safety. Practice safe habits around firearms at all times.

When trapping it is generally a good idea to keep your firearm unloaded until you need to use it. It can be difficult to maintain control of a firearm when you are carrying gear and making sets.

When you shoot at an animal in a trap, be especially careful about ricochets off the trap or other hard surfaces such as rocks or hard soils. Ricochets may also occur off from water. If you are trapping with companions, everyone should stand behind the shooter.

Always look beyond your target when shooting a firearm and only shoot if it is safe. Keep the muzzle under control and pointed in a safe direction at all times, even when the gun is not loaded.

Getting Lost

It is easy to get lost if you are in unfamiliar territory. When you are looking for sign and places to make sets you may not be paying close attention to landmarks and trails. Always carry a map of the place you are trapping and a compass. Many people carry a global positioning system (GPS) unit. If you carry a GPS, make certain you know how to use it and carry extra batteries but still carry a compass for a backup in case your GPS is not functioning. You can also use a GPS to mark the locations of your trap making them easier to relocate in areas unfamiliar to you.

Additional Safety Tips

Although many people trap alone it is best to use the buddy system for any outdoor activity. That way if you are injured or sick your buddy can assist you or go for help.

Always tell your family exactly where you are going and when you plan to return. If you change locations or plans, let your family know. Leave a map of your trapline at home.

Wireless or cell phones are a good safety tool for trappers. Do not rely on the phone to get you out of all situations though. You could be out of range or find yourself with a dead battery when you need your phone the most.

A trapper must know how to start a fire. Carry waterproof matches and fire starting materials with you at all times. If you find yourself in a hypothermia situation it may be difficult to start a fire without a these items.

Chapter 6 Equipment and Preparation

What do you need to learn and do before you go trapping? You will need to learn trapping laws and regulations and obtain traps and other equipment. You must prepare the traps, make or purchase baits and lures, and study the furbearers you plan to catch. Before trapping season arrives, a wise trapper will practice making different kinds of sets and will thoroughly scout the area he or she plans to trap. Careful and complete preparation will increase both your enjoyment of trapping and your chances of success.

Trapping Equipment

The right equipment is essential to trapping success. In trapping, as in so many other activities, quality equipment is the best investment in the long run. By being prepared for the most wary and difficult-to-trap animals, the trapper can take advantage of all trapping opportunities. The following is a list of the contents of a typical fox trapper's pack basket: traps, gloves, pan covers, dirt sifter, stakes, bait jar, digging tool, lure, hatchet, kneeling pad, wire, urine, pliers, swivels, and extra trap tags. As you gain experience over time, you may find that you can get by with fewer items than those listed above. On the other hand, you may develop your own list of "essential" equipment that includes many additional items beyond this basic list.

Carrying Your Equipment

The trapper must have something in which to carry all the equipment needed. If you trap primarily on foot, a pack basket is the best approach for carrying your equipment. Many trappers use a woven wood or fiberglass pack basket rather than a canvas pack because the basket is more rigid and more convenient to use as well as less likely to hold odors. Lure and bait are usually carried in a separate pouch or in a coat pocket to avoid contaminating traps with their odors.

If you trap from a vehicle, boat, or canoe, several other types of containers may be better options. Plastic buckets, milk crates, and totes are particularly useful for trappers who do little walking while running their trawlines. These containers can also be used for transporting any animals that are caught and help to keep the vehicle or boat clean by containing water, blood, and mud.

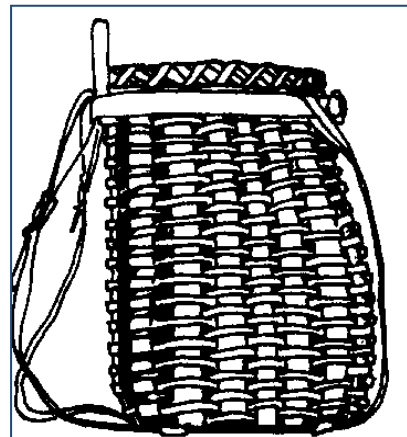

Gloves

If you make only dry-land sets, a pair of clean, odor-free cotton gloves may be sufficient. Many trappers prefer rubberized gloves to reduce human scent at the set. Either the short rubber gloves or arm-length gauntlets are very useful to water trappers. They will more than pay for themselves in comfort and preventing



chapped skin or frost bite. Keep gloves clean, and keep bait, lure, or other odors off the gloves. Some trappers carry an additional pair of heavy gloves solely for handling animals.

Digging Tool

Many sets call for a bit of digging. Most trappers use some type of long, sturdy trowel. Special trapping trowels are available, but other options include a tile spade, small folding shovel, garden trowel, or large spoon. Modified hammers with digging blades welded on are also available and good options in areas with compact or rocky soils. Buy the best one you can afford as it will see frequent use.

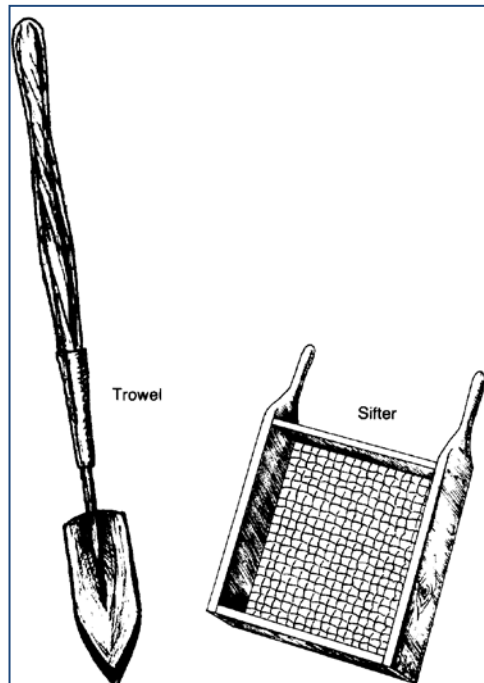

Dirt Sifter

A dirt sifter is simply a mesh-bottomed box. Most trappers make their own using a wooden frame about 8" x 10" x 3" and tacking in a bottom of 1/4" hardware cloth. A sifter is extremely useful in dirt or snow trapping. Covering the trap is required in most cases and reduces the likelihood of damaging trapped animals, and sifting the covering material helps to prevent stones or twigs from jamming the trap. Several commercial models of sifters are available.

Traps

You will need traps of the right size and type for the species you wish to target. Traps with teeth are illegal to use in New York State. By law, all your traps must be clearly marked or tagged with your name and address or your license ID number. Appendix 1 lists appropriate trap sizes, set types, and effective baits and lures for each furbearer species found in New York.

Long-spring traps have the longest history of design as steel traps but because they contain more metal they are heavier. Single or double long-spring traps may be the best choice in situations where traps can be easily concealed and the extra weight might be an asset (such as in submersion sets for beaver, otter, mink, and muskrat).

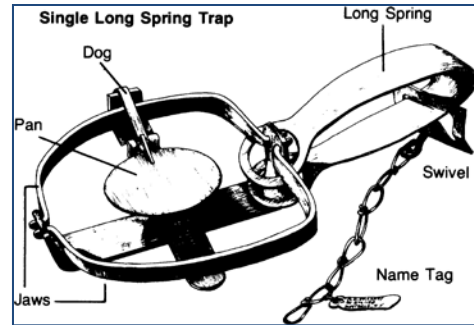

Guarded traps (also referred to as “stoploss” traps) are available in several styles from several manufacturers. They employ an additional spring-loaded jaw or bail that helps prevent muskrat or mink from escaping. Many muskrat trappers use these types of traps almost exclusively.

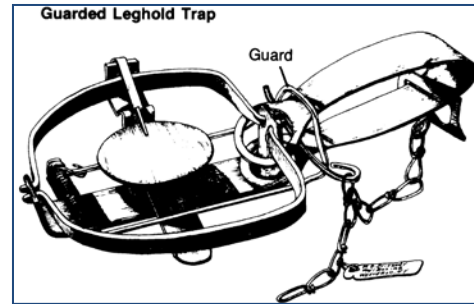

Under-spring or jump traps are no longer manufactured but are frequently found on the used trap market. They are more compact and therefore easier to conceal than long-spring traps. While they are a little more difficult to set than long-spring traps, jump traps are a bit faster closing. They are also significantly lighter in weight than long-spring traps. Some manufacturers produced double as well as single under-spring traps.



Coil-spring traps operate the fastest of the foothold traps. Available in many sizes from a variety of manufacturers, coil springs are often used in trapping predators. They have all the advantages of under-spring traps with the addition of increased speed and holding power.

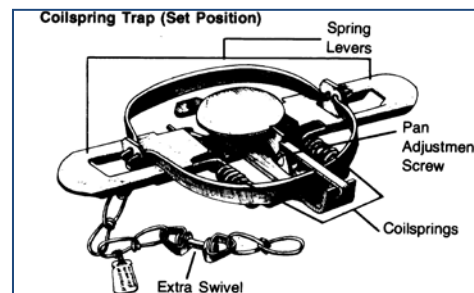

Padded coil-spring traps have rubber pads on the jaws. These are another tool which can be used when situations warrant, such as when chances of encountering free-roaming domestic animals are high.

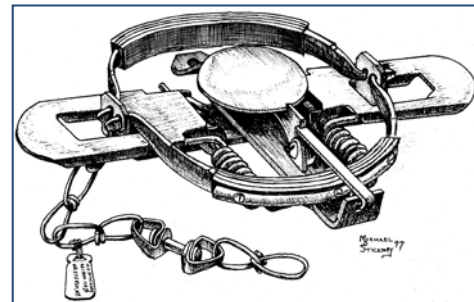

Foot encapsulating traps are designed specifically for the capture of raccoon. They are designed to fully enclose the trapped paw of the raccoon to prevent self-inflicted damage. These traps have a restricted opening to minimize the capture of unintended animals. Some operate with a pull-type trigger to further increase selectivity. Foot encapsulating traps are set with bait or lure inside the trap such that a raccoon will attempt to reach in the entry hole to grab the bait, firing the trap. These

traps are more expensive than traditional steel traps but most are simple to use and very efficient at capturing the intended animal. They are an excellent tool for beginning trappers.

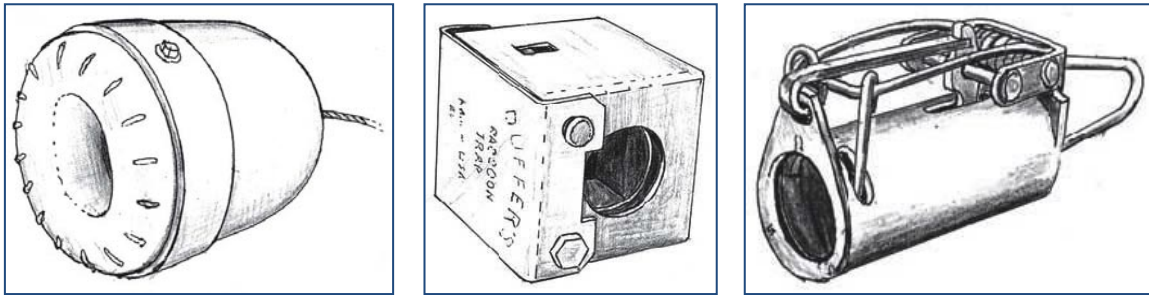

Body-gripping traps are the result of many years of research and design. They are designed to catch an animal around the neck or chest. When properly set, these traps usually kill the trapped animal quickly. If a chest hold occurs, the animal is killed by asphyxiation, with death coming quite rapidly.

Body-gripping traps are very popular with water trappers and are quite useful in some kinds of land sets. **CAUTION: BODY-GRIPPING TRAPS SHOULD NOT BE USED IN PLACES OR IN WAYS THAT MAY TAKE UNINTENDED ANIMALS.** Body-gripping traps are not adaptable to all types of furbearers, such as canines, or to a full range of sets. Larger body-gripping traps (more than 7 ½ inches) are illegal to use on land. Medium-sized body-gripping traps set on land must adhere to special use requirements set by regulation. **Review the trapping regulations thoroughly before using any body-gripping traps.**

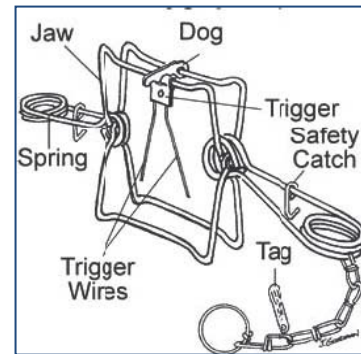

Box or cage traps of various kinds are useful in trapping some species in situations where the risk of taking domestic animals is high, such as when trapping nuisance wildlife around farms or homes, because unintended captures can be released unharmed. Like body-gripping traps, however, their use is limited, especially for foxes and coyotes, which avoid them. The cost and size of box traps are also disadvantages on trap lines.

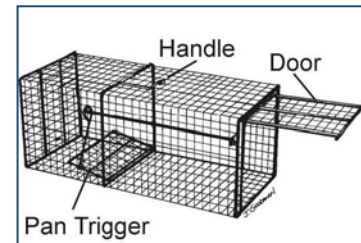

Cable restraints or traps (also referred to as snares) are illegal to use in New York, even though they may be available for sale.

Pliers and Cable Cutters

Trappers frequently use lengths of wire or cable in making sets. A pair of pliers is very useful in cutting and twisting wire. They may also be used for field repair of equipment and in adjusting



trap triggers. The pliers should have a cutting edge and should be treated along with the traps to protect them and prolong their life. When cutting cable, use cable cutters only. Pliers will not effectively cut cable.

Wire and Cable

Wire and/or cable have many uses on the trap line. Wire and cable can be used to repair chains, make submersion sets, or attach traps to stakes. They also are used to hold traps, baits, or even cubby pens in place. Many trappers prefer a dark wire for these purposes. Strong 16-gauge wire is recommended for muskrat and 11-gauge wire or cable for larger furbearers. CAUTION: Beware of kinks or nicks because they will weaken the wire or cable. Do not use wire to extend trap chains; instead, use additional chain or cable.

Swivels

A swivel connecting the trap to the chain allows the trap to turn freely on the chain. This keeps the chain from binding and prevents undue stress or leg damage to trapped animals. In general, the more swivels, the better. Swivels can be rendered ineffective when tangled in vegetation or clogged with mud, so having more than one in your anchoring system will increase the odds that your trap will continue to turn freely after a catch. A good minimum is three; one at the trap end of the chain, one at the stake end, and one in the middle. Swivels placed close to the trap have the best chance of continuing to operate and allowing the trap to rotate if the chain becomes wrapped around an object.

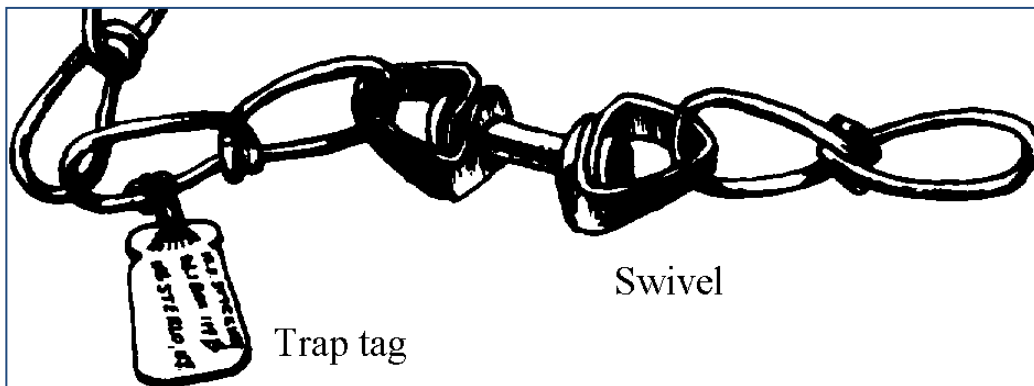

Trap Tags

Trap tags must be durable and easy to read. They must be firmly attached to the trap so they will not come off. In New York, every trap must have a tag that legibly bears the name and address or the license ID number of the trapper.

Shock springs

A shock spring can be added to the chain of restraining traps to improve the holding ability of the trap and improve animal welfare. Shock springs can either be in-line or off set with the chain to provide cushioning when the animal reaches the end of the trap chain. These are most often used on fox and coyote traps.

Hatchet

Every trapper needs a good hatchet on the trap line. Staples or stakes must be driven, and ice sometimes must be chopped in making or checking sets. Learn how to sharpen your hatchet and use it safely. Carry hatchets with the sharp edge covered.

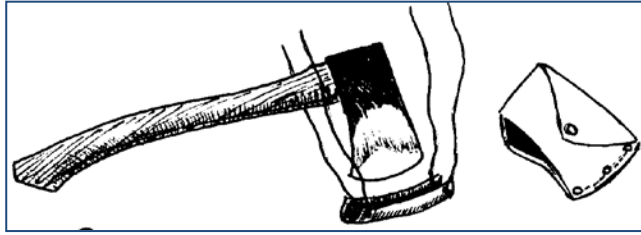

Kneeling Pad

Some trappers use a square of cloth, rubber or plastic as an odor barrier to kneel on when making dirt-hole sets. Others make these sets from a squatting position, letting only their clean, rubber footwear touch the ground. New trappers should try each way to see which they prefer.

Pan Covers

These items of wax paper, canvas, or other material are used by some trappers to prevent materials from getting under the pan of the trap. Other trappers consider them unnecessary and point out that they may carry human odors. Beginning trappers should determine the need for them by trying both techniques.

Catchpole

Many trappers carry a catchpole—a pole or length of tubing with a rope or cable attached. This highly recommended tool can be used to control a trapped animal so it can be released or dispatched more safely and easily. A catchpole can be made by running a loop of plastic-coated cable through a three- to four-foot piece of rigid aluminum pipe or conduit.

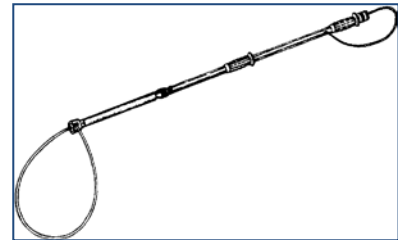

Attaching one end of the cable to the pipe makes use easier. High-quality catch poles used in the nuisance wildlife trapping industry may also be purchased.

Another alternative to using a catch pole is to use a large piece of plywood with a v-notch cut into the bottom. Attaching a handle to the trapper side of the plywood will make it much easier to use. To release an animal, the trapper places the board between himself and the animal and slowly approaches the trap. Once the trap is reached, the v-notch is placed over the animal's foot that is being held by the trap, allowing the trapper to open the trap jaws and release the animal while being protected by the board. This is the preferred method for releasing bobcats and house cats as it is possible to over tighten a catchpole on a cat.

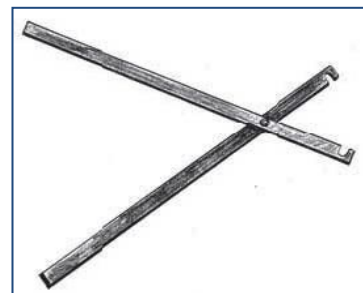

Trap Setter

Larger body-gripping and foothold traps often require considerable effort to set. Some trappers carry a trap setter (levers attached like scissors) to help handle these powerful

traps. Large body-gripping traps may also be set by using a length of strong small-diameter rope with a loop on one end. The trapper's foot is placed in the loop. The free end is then fed through the "eyes" of the trap springs twice. By pulling up on the free end, the trapper can compress the spring and engage the safety latch.

Safety Gripper

Whenever setting large body-gripping traps, the trapper should use a safety gripper tool. Several types are available but all perform the same function of keeping the trap jaws from fully closing should the trap fire during setting.



Anchoring Devices

Trap stakes for dry land sets can be hardwood, metal, or—more recently—earth anchors. The stake must be adequate to hold the largest animal the trap may catch. Under most conditions, stakes should be about 12 to 18 inches in length. In sandy soils, even longer stakes are needed. In very loose soils, or when trapping animal like coyotes that push anchoring systems to their limits, it may be necessary to use two metal or wood stakes driven into the ground at such an angle that they form an X. This method is known as cross-staking and trappers can purchase commercially available swivels for this purpose or make their own. Metal stakes should be treated to remove foreign odors in the same manner as the traps themselves. The trap chain should be attached to the stake so it swivels on the stake. Be sure the trap and chain swivels are functioning properly because swivels protect trapped animals from unnecessary injury.

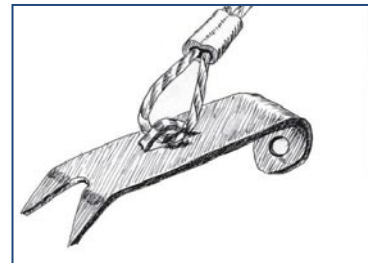

Stakes can also be used to anchor traps set in water for muskrats and other animals associated with water. As always, stakes must be large enough to hold any animal which might be captured. Do not use fresh willow or other branches as stakes. Willow sticks can take root and clog waterways, and recently cut pieces of any tree or brush may be chewed by beavers, rendering your stakes useless. If you do cut your own stakes from trees or brush, cut them well in advance of the season so they have a chance to dry and age. These will be much less attractive to any beavers in the area. Wood lath, which can be purchased at most hardware stores, is a handy way for muskrat trappers to stake small body-grip traps.

Drags

Where stakes are not practical or desirable, as in very rocky soils, drags are sometimes used; however you should avoid using drags whenever possible because animals can escape and take your traps with them. Good sign reading and tracking skills are important when using drags as you'll have to locate the animal after making a catch. Drags must be large enough to keep the

animal from escaping with the trap. Some trappers use metal drags resembling 2- or 3-pronged hooks. A few trappers use a heavy section of seasoned hardwood. A wood drag about 4 feet long and at least 3 inches in diameter is usually adequate for raccoon trapping. When drags are used, extended chains at least 6 feet long connect the trap and drag. In general, the longer the chain used, the quicker the animal will become entangled and therefore be easier to find.

Bait, Lure, and Urine

Bait and lures are used to attract animals to the set. Baits, lures, and urines are used in various combinations according to each trapper's individual preference. With experience, each trapper develops techniques that work best for him or her.

Lures and baits are used to draw the animal into the area and to get the animal to work (explore) the set, thus stepping into the trap. The odors of baits and lures should be kept off the traps themselves because lure-contaminated traps may cause some furbearers, like foxes, to dig the traps out of the set. Baits and lures should be carried outside the pack basket to prevent trap contamination.

Bait and lure combinations abound. Most trapping books contain information on lure preparation, and many trappers prepare their own baits and lures. Only experimentation will tell which baits and lures are best for a particular set. Experienced trappers are always trying new things. Beginning trappers would be wise to use commercial lures until they develop their own. A new bait or lure should be used on only a few sets until it has proven successful.

Responsible trappers try to use the most selective baits and lures possible. Some trappers use animal urine as an attractant and suspicion remover when trapping fox, coyote, or bobcat. In general, gland lures and urines are very selective furbearer attractants. Never use cat or dog food for bait. Never use exposed carcasses as bait, as they may attract birds of prey. Cover all carcasses with a layer of soil, grass, leaves, or other vegetation so they are not visible from above or enclose them within a cubby. Refer to the natural history section about the species you are trapping to help determine the best bait and lures.



Trapping Equipment Preparation

All equipment used in land trapping should be clean and free of foreign odors. When traps come from the manufacturer, they are coated with oil. Before they can be treated, the oil must be removed, which can be accomplished by washing in detergent or boiling in wood ashes or caustic soda solution. Traps can also be soaked in a solution of vinegar and water for a few days to remove the oil coating. After one of these cleaning processes, leave new traps outside to get a light coating of rust, which will help whatever treatment is used to adhere to the metal.

All traps should be checked and adjusted so that the pans sit level when set. Make sure each trap has a readable tag as required by law. Remove all sharp edges and burrs. Check chains, stakes, and drags for weak spots before treating and after each catch. Replace worn or broken parts immediately.

The traps, chains, drags, and stakes, along with any other metal or equipment, can now be treated. Place a small piece of wood or wire between the jaws of the traps to hold them open during treatment.

Many coloring or dyeing agents are used for treating traps. Logwood powder or chips, sumac berries, walnut hulls, hemlock bark, and maple bark are some of the commonly used agents. A strong, hot solution of the material is kept at a simmer, and the traps are left in it until they become black. This dye coat prevents or slows rusting, makes the trap easier to conceal, and helps remove undesired odors. New traps are much more difficult to dye than traps that already have a dye coat or a fine film of rust.

Traps that are to be used in land sets are often waxed to prevent further rust. You can buy trap wax or make it with paraffin mixed with a small amount of beeswax and a pea-sized piece of pine resin. Some trappers coat the traps with a thin wax film by carefully placing hot, dry traps in a smoking hot wax solution. The objective is to coat all parts of the trap with a very thin layer of wax. **USE EXTREME CAUTION!** The wax is flammable. Traps should only be waxed outdoors and away from buildings. Keep fire control devices such as a garbage can cover nearby to smother any fires. Having a fire extinguisher on hand is a very good idea.

Do not wax body-gripping traps. Waxed body-gripping traps become very difficult to set, frequently springing unexpectedly. They cannot be depended on to stay set, and they may be dangerously sensitive while being set.

After being dyed and waxed, hang the traps in the open air away from foreign odors, handling them only with clean gloves. Traps that pick up foreign odors or food odors should be re-treated before being used again for land sets.

Some trappers use commercial dips to treat their traps. These dyes are mixed with lantern fuel, gasoline, or even water depending on the type. Be extra cautious and stay clear of any possible

ignition sources. Once mixed, the trapper simply dips the cleaned traps and hardware into the solution and hangs them up to dry. This results in a hard, durable finish on the metal. At first, the finish will be shiny but it will become dull with time and use. To get the best finish, trappers should dip their traps only on warm, sunny days with low humidity. Humid conditions may cause the finish to feel sticky. After dipping body-grip traps, particularly those to be used in water, you may wish to remove the dip from parts of the trigger assembly because the dipped finish can cause the trap to become difficult to set, much the same as when waxed. Use sandpaper or a small file to remove the finish from those areas.

Another alternative to dipping or dyeing and waxing your traps is to paint them with a coat of flat or matte spray paint. Be sure the trap is cleaned first and allowed to fully dry. Some trappers even use multiple paint colors to create a camouflage effect on their body-grip traps to better conceal them from furbearers and trap thieves alike. This popular treatment is done less often with foothold traps intended for use in land trapping.

Every effort should be made not to contaminate the traps with lure, bait, human scent, smoke, or blood from previously trapped animals. Similar precautions should be used with all the other items that are left at a set and tools that are used at the set (e.g. trowel, pliers). Clean traps won't help if there are odors on a stake or chain which give the set away.

Metal box traps may be treated like other traps, but wooden box traps should be permitted to weather before being used. Painting is an excellent option for treating these traps as well.

Chapter 7 Best Management Practices

Trapping “best management practices,” or BMPs, are actions, equipment, and techniques that improve animal welfare, help avoid the unintended capture of other animals, and increase public support for trapping.

DEC strongly encourages trappers to use trapping BMPs at all times because these will help sustain regulated trapping as a wildlife management tool and maintain the integrity of wildlife conservation programs throughout the United States. Trapping BMPs are based on the most extensive research effort of animal traps ever conducted in the United States, including research conducted in New York. Traps tested were selected based on knowledge of commonly used traps, previous research, and input from expert trappers.



Where to find detailed BMP information for each furbearer

Trappers can find all current information on trapping BMPs at the following web site:

http://jjcdev.com/~fishwild/?section=best_management_practices

On this site, trappers can find summary BMP documents for all species of furbearers found in New York.

The Furbearer Management web site is maintained by the Association of Fish and Wildlife Agencies (AFWA) on behalf of state fish and wildlife agencies, trappers, and trapping organizations.

Background information

In 1996, the then International Association of Fish and Wildlife Agencies (this organization is now known as the Association of Fish and Wildlife Agencies) began a program to develop Best Management Practices (BMPs) for trapping as a way to improve the welfare of captured animals and to document improvements in trapping technology. This project is one of the most ambitious in the history of the conservation movement.

AFWA coordinates the development of BMPs for trapping. AFWA’s membership includes all 50 state fish and wildlife



management agencies, federal agencies, and conservation organizations. Biologists from New York have been heavily involved in this effort via a multi-state committee of fish and wildlife agency biologists.

State furbearer biologists, veterinarians, trappers, and scientists from the University of Georgia and the University of Wyoming cooperated on the development of BMPs. The United States Department of Agriculture provided most of the funding for trapping BMP research and development.

BMPs are based on the most extensive research effort of animal traps ever conducted in the United States. Traps tested were selected based on knowledge of commonly used traps, previous research, and input from expert trappers.

Trapping BMPs were developed to give wildlife professionals information they need to improve animal welfare. State fish and wildlife agencies will use BMPs to continue the improvement of trapping systems throughout the United States.

Trapping BMPs include suggestions on practices, equipment, and techniques that will provide trappers and wildlife biologists with practical information to use in the field.

BMP Evaluation Criteria

BMP traps were evaluated using criteria to measure the effects on animal welfare as well as trapping efficiency, selectivity, practicality, and safety.

Animal Welfare - Researchers used live restraining traps to test for injuries to furbearers using two methods. One system evaluated specific injuries, and the other grouped the injuries into categories from mild to severe. BMP-approved traps must have a low rate of injuries to the furbearing animals being studied. Recommended traps resulted in moderate, low, or no injury to at least 70% of the animals trapped.

Efficiency - Traps meeting BMP criteria must be able to capture and hold at least 60% of the furbearers that spring the trap.

Selectivity - Traps must be set and used in a fashion that limits the risk of capturing non-furbearing species while increasing the chances of capturing the desired furbearer.

Practicality - Each recommended live restraining trap was evaluated by experienced trappers and wildlife biologists for practicality. Criteria used to measure practicality include cost, ease of use, ease of transport, storage, weight and size, reliability, versatility, and the expected life-span of the trap.

Safety - Each recommended live restraining trap was evaluated for safety to the user and other people who might come into contact with the trap.

BMP Results

While BMPs do not specifically recommend which brand of trap should be used (though they do note the particular brand that was tested and passed the criteria listed above), they do list specifications of those traps that performed the best. For example, for coyote (eastern United States), coil spring traps with plain jaws and a 5 to 5 ½ inch jawspread performed best. The Woodstream™ Victor No. 1.75 and No. 2 traps were tested for this category.

See http://jjcdev.com/~fishwild/?section=best_management_practices for the full set of BMP publications, including detailed listings of all traps that passed the rigorous BMP research criteria.

Chapter 8 Selective Trapping Techniques

Selective trapping is a challenging activity. Each time you set a trap, you should make the set to catch a specific furbearer or small group of furbearers (i.e. mink and muskrat, beaver and otter, fisher and raccoon). You should also take steps to prevent catching pets or other unintended animals. The information in this chapter will give you an introduction to selective trapping techniques in preparation for understanding the chapters on making sets.

Location, Location, Location

The location of your set is the first consideration for selective trapping. Each species of furbearer lives in a certain kind of habitat, eats certain kinds of food, and follows certain habits. Use this knowledge to find the best places to set your traps. Pre-season scouting will reveal which locations are best for your intended



furbearer. However, abundant sign of the desired animal is not the only determining factor in whether or not you have found a good location for a set. Other factors must be considered:

- Is the location near a trail that is heavily used by people and their pets?
- Do hunters using dogs use the same area?
- If you catch an animal, will it be visible to people passing by?

You should be able to answer “no” to each of these questions. If you answered “yes” to any of these questions, do not set traps in this location.

Once a suitable location has been found, there are several additional techniques that can be employed to increase the selectivity of your set. For example:

- If you make a muskrat set at the edge of a stream, you can avoid trapping ducks and other water birds by sticking branches out of the stream bank above the trap. Muskrats can pass below the branches, but ducks will be hesitant to do so.
- You can make a cubby for raccoons that will keep most dogs from approaching the trap by narrowing the height of the opening.

Attractants

The proper use of bait, lure, and urine is a key factor in selective trapping. Each furbearing animal responds to certain food smells. Glandular lures can appeal to a specific animal's curiosity or territorial urges. Never use pet food for bait. Avoid other baits that might attract dogs or cats. For example, fish might attract cats if you are trapping near homes that have pets. For some species like raccoon, consider using sweet baits (baits that use fruit as a base) instead of meat or fish to minimize the chances of attracting dogs or cats. While the use of selective attractants will minimize the chances of unintended catches, they are not foolproof. Therefore, the trapper must continue to employ all other techniques to avoid catching domestic and other unintended animals.

If large baits such as animal carcasses are used, be sure to cover them so that they are not visible from above. This will protect against the accidental capture of birds of prey, which hunt by sight. The scent coming from the covered bait makes your set attractive to many furbearers that forage primarily through their sense of smell.

You've got the location, now what?

Choosing the proper size and type of trap for the situation and species being sought is also a key component of trapping selectively. The size of the jaw spread and strength of the spring can help catch and hold a specific furbearer. Pan tension is an important consideration as well. Try two pounds for fox or bobcats and four pounds for coyotes. Trigger length and placement in body-grip traps can help you to target certain furbearers like beaver, while avoiding the capture of others like otter or muskrat.

Trappers can use the BMPs developed by AFWA to aid in the selection of the proper traps for various furbearer species. Recall from Chapter 7 that two criteria of the BMP trap testing process were selectivity and efficiency. The BMP trap-testing process has saved today's trappers a lot of trial and error by scientifically evaluating many of the traps available today and highlighting which trap types and specifications are best for a particular species. BMPs can be found on the AFWA website at:

http://jicdev.com/~fishwild/?section=best_management_practices.

Trap placement is another factor in selective trapping. At a dirt-hole set, for example, try placing the trap so the pan is 7 inches from the bait hole for fox, and 12 inches for larger coyotes. Give thought to the physical characteristics and habits of the animal you are trying to catch and let them guide the placement of your trap.

Talk to the landowner

Responsible trappers make every effort to learn all they can about the property they trap and who might be using the property for other activities. Find out who else has permission to be on the property and when they will be there. This will help you avoid problems, and you may make some new friends in the process. Try to talk to the other



users of the property so you can work out a plan that will allow everyone to use the property to your enjoyment while avoiding potential conflicts.

Public areas provide millions of acres of land and water where trapping is permitted. During times of heavy public use for upland bird hunting, it is a good idea to focus on water trapping to avoid the possibility of catching dogs. Since most furbearers are nocturnal, you can make sets in the evening and pull them or trip them the next morning. Local wildlife biologists, rangers, or conservation officers can tell you about the most heavily used hunting areas so that you can avoid them when hunters are running dogs.

These are just a few examples of the ways you can make your sets more selective and avoid unintended catches. To learn more, study BMP documents and the natural history of the species you trap.

Chapter 9 Natural History of New York Furbearers

It is very important for trappers to know furbearer natural history. Understanding each species' habits and habitat helps you select good set locations. Set location is much more important than set construction. Landowners may be able to supply some information about the animals on their land, particularly problem animals, but pre-season scouting will help you determine if the location is good for your intended species.

Scouting includes observations of animal tracks, scats, droppings and other signs. The ability to read sign is an acquired skill, and the information included in this chapter can help you develop this skill.

Sets mentioned in this section are more fully described in Chapters 10 and 11. Examples of furbearer tracks are located in Appendix 2. Drawings of the scat of each of these animals are found in Appendix 3. Up-to-date range maps for each species in the northeastern United States and Canada can be found at www.conservewildlife.org

Muskrat (*Ondatra zibethicus*)

Musk rats resemble large rats with long, vertically flattened tails. They reach a total length of about 26 inches, including the tail, which is about as long as the body. The maximum weight is 3 to 4 ½ pounds. Their pelts are usually a rich, glossy brown with brown-tipped, dark gray underfur, but the pelts may range from tan to black. The belly is silvery gray to light rusty tan. Although they are small, muskrats are abundant, and their annual dollar value probably exceeds all other North American furbearers.

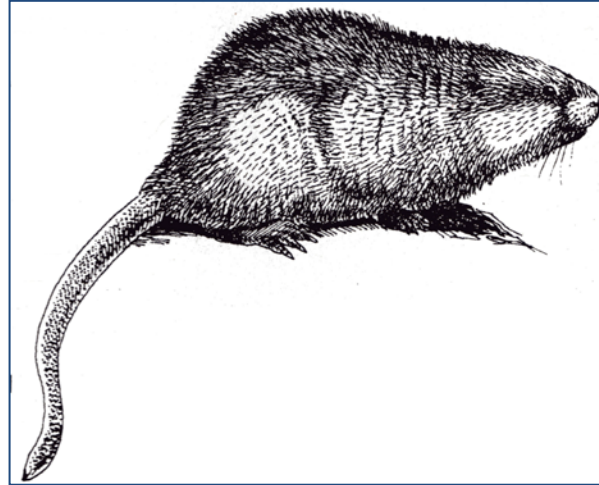

Reproduction

Musk rats breed through the spring and summer and are capable of producing many offspring. While the usual number of young per litter is 5 to 6, as many as 11 have been recorded. Musk rats may have 2 to 3 litters per year, and their gestation period (length of development inside the mother) is 22-30 days. Dens may be bank burrows or small dome-shaped huts in relatively shallow water.

Habitat

Musk rats are largely aquatic. They are found in fresh and brackish water marshes, swamps, streams, lakes, and ponds. Nearly every older farm pond has muskrats, and nearly any semi-permanent watercourse has at least a few. Beaver ponds, both active and inactive, are suitable muskrat habitat.

Habits

Like most other furbearers, muskrats are most active at night (nocturnal) or around dawn and dusk (crepuscular). They are frequently seen during the day, however. They travel extensively along watercourses, even small spring runs, or over land. These travels are most frequent during the fall and right after ice-out in the spring.

Trails, channels, plant cuttings, tracks along banks, and scats are all signs of muskrat activity. Musk rats develop habitual travel routes on land and in water, which they keep open with constant traffic and pruning. These trails are readily evident to the experienced eye. Active bank burrows about 4 to 8 inches in diameter, feed beds of cut grasses or cattails, and huts are also positive muskrat signs.

When muskrat populations are dense, adult males tend to fight, leaving a large number of cut and injured animals in some populations during March and April.

Although their teeth, like those of other rodents, are adapted to feeding on vegetation, muskrats will eat clams, mussels, frogs, and fish as well as cattails, rushes, water lilies, and other aquatic plants. They are also fond of fruit and grains, if available near water.

Disease

Muskrats suffer from several diseases, including tularemia and hemorrhagic septicemia. Since humans can be infected with tularemia, avoid any contact with muskrats found dead or dying of no apparent cause. Wearing rubber or plastic gloves while skinning trapped muskrat can minimize the risk of contracting tularemia.

Trapping Tactics

Muskrat pelts are best in winter or early spring before biting occurs. However, pelts taken in late fall are also marketable.

Muskrats are not trap shy. In most instances, well-darkened traps set under water need no covering at all. Muskrats may be taken in bait sets, runway or channel sets, and float sets. Some of the most productive blind sets are those placed in narrow waterways, along stream or pond banks where recent muskrat signs are present, or at feed beds. Whenever possible, use small body-gripping traps for muskrats. Foothold traps in sizes 1 and 1½ are also appropriate, and the sets should be made to ensure the animal is submerged. Where the water is not deep enough to ensure submersion (about a foot), a guarded foothold trap or a body-gripping trap should be used. This is necessary because if a standard foothold trap is used and the muskrat isn't submerged, it may twist and pull until it escapes, leaving its foot in the trap. This is called "wring-off," and is to be avoided at any cost. Using recommended techniques and state of the art traps, this can be completely avoided. Submersion sets and body-gripping traps will eliminate this problem. If a trapper is not absolutely sure that he or she can submerge a muskrat at a particular site, the trapper must use either a body-gripping trap or a guarded trap, or move the set to another location where the catch can be submerged. Trappers who find evidence of wring-off, or find live muskrat in their traps, should immediately re-evaluate their trapping methods to prevent this from happening again.

Baits and Lures

Muskrat lures and baits are numerous. Muskrat musk is frequently used in spring trapping. In the fall and winter, trappers use oil of sweet flag, spearmint, anise or some other sweet-smelling oil as an attractant. Fish oil is also attractive to muskrats. Apples, parsnips, and carrots are all used successfully as muskrat baits.

Mink (*Mustela vison*)

Mink are medium-sized members of the weasel family. Like others in the weasel family, they have long, slender bodies and short legs. Large males reach lengths in excess of 26 inches, with tails about 9 inches long and weights up to 3 ½ pounds. Females are smaller than males.

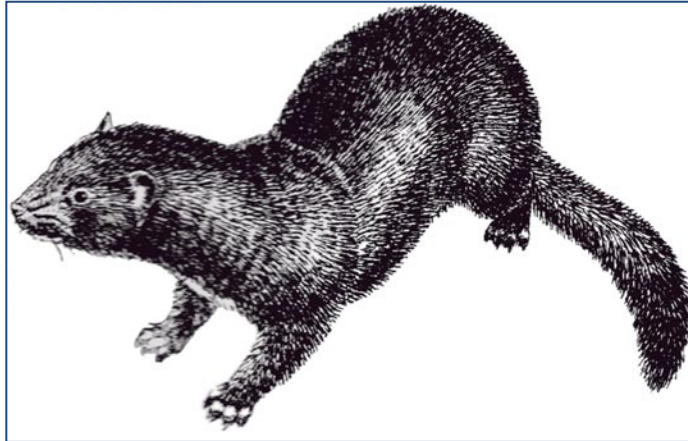

Mink pelts are usually rich, glossy brown, but pale brown or nearly black mink occur. Mink can be distinguished from weasel by their white chin patch and brown belly. While weasel are light underneath, mink will only occasionally have white on their bellies. The bushy tail is usually a bit darker than the body. The mink's short, dense underfur is pale brown.

Reproduction

Mink mate in late winter from January through March. Litters of 2 to 6 young are born in April or May after a variable gestation period averaging about 42 days. Only a single litter is born each year.

Dens may be in debris piles, hollow logs, rock piles, or abandoned muskrat houses or burrows near water. Females usually remain near dens, while males wander over considerable distances.

Habitat

Mink are most often found near streams, lakes, marshes, or swamps, but they may travel considerable distances from those wetlands.

Habits

Mink are primarily nocturnal but will often hunt during the day. Feeding mainly on fish, frogs, birds and small mammals, these predators hunt primarily along watercourses. They are equally at home on land and water, but most of their traveling is done along stream or lake edges. Like raccoon, they enter the water readily to avoid obstructions. Mink are curious and thorough in their search for food. Nearly any hole, brush pile, hollow log, or other potential food-producing cover along their route will be visited. They are creatures of habit, visiting the same places on each trip through an area.

Males visit small feeder streams, spring runs, and even drainage tiles in their rounds; usually travelling longer distances than females. Headwater areas are frequently the denning areas of resident females. Mink scats are generally abundant in such areas. During the winter, mink travel extensively under the ice.

Disease

Generally, mink have few diseases. However, they are susceptible to distemper and pollutants such as polychlorinated biphenyls (PCBs).

Trapping Tactics

Mink fur is best from about mid-November until the beginning of January. Fur from animals taken later in the season is likely to be “singled” (curling of guard hair) or discolored.

Mink are taken in a wide variety of sets. Water sets for mink are easier to make than are dry-land sets. Blind sets where mink tracks enter or leave the water, at bank holes (pocket sets) or in small spring runs or drainage tiles are all effective methods. Cubby sets, particularly artificial bank-hole cubbies using mink lure, are good mink sets. Dirt-hole sets for fox or raccoon occasionally take mink.

Mink are strong and quick, so traps for them should be strong and fast. Coil-spring or under-spring traps in sizes 1 or 1½ are preferred. Longspring traps can be used successfully with the added weight advantage for submersion sets. Small body-gripping traps (especially with double springs) will take mink. Submersion sets should always be used with foothold traps. Pan tension should be very light for mink. Just enough to keep the trap set until stepped on.

Baits and Lures

Muskrat or mink musk, scats, urine and beaver castor are all attractive to mink. Fish oil alone or in combination with the above ingredients is also a good lure. There are many commercial lures on the market as well.

Good lures and blind sets are usually the most successful techniques with mink, but fresh fish, poultry, or muskrat flesh also work well as mink baits as long as special care is taken not to attract domestic animals.

Beaver (*Castor canadensis*)

The beaver is a large, aquatic rodent with webbed rear feet and a horizontally flattened, paddle-shaped tail. The largest North American rodent, beaver may be more than 45 inches long, including the tail, and reach weights of more than 60 pounds. With soft, dense underfur ranging from pale to chocolate brown and rich brown guard hairs, their glossy, durable coat is a valuable fur.

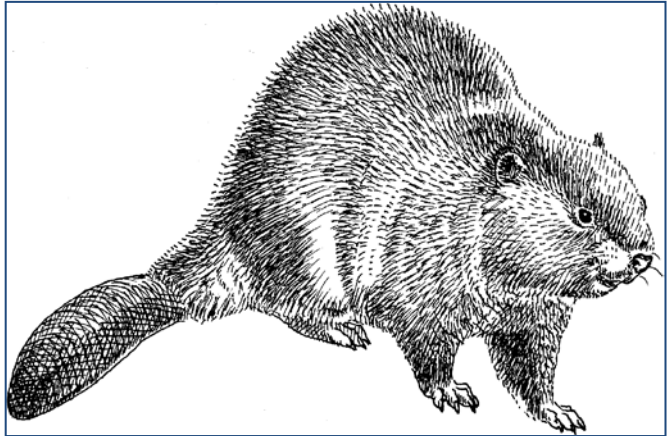

Reproduction

Beaver are apparently monogamous (have only one mate). They breed from January to March, with the young born about 128 days later. Litters range in size from 1 to 8 young, but 2 to 4 are usual. The young remain with the parents for about two years, maturing at 1 to 2 years of age. Beaver have one litter per year.

Dens are in either large bank holes (burrows) or large, dome-shaped, stick-and-mud lodges. Entrances and exits are generally below the surface of the water.

Habitat

Beaver are semi-aquatic mammals, generally found near water. Young adults looking for a new area to live may travel considerable distances along very small water courses. Suitable habitat may be natural, or dams may be constructed by the beaver where other conditions are favorable.

Beaver are the one animal in New York (other than humans) which actively alters its environments to suit its needs.

Habits

Beaver are mainly nocturnal or crepuscular. They prefer rather deep water and will construct mud-and-stick dams to create those preferred conditions. Typically, each adult beaver pair constructs a lodge that they occupy with their kits and yearlings.

Beaver feed on both bark and aquatic vegetation, and winter food stores (feed piles) are composed of quantities of branches lodged in the bottom of the pond. Their preferred foods include aspen (poplar), alder, and willow, but several other types of trees and aquatic plants are also used.

Generally, beaver use habitual runways in their travels. In late winter, they go considerable distances to areas of open water. Secretions from the castors (scent glands) are deposited on scent mounds made of mud along the banks as a means of communication.

Active beaver colonies can be identified by the presence of dams, channels, lodges, freshly cut trees or brush, tracks, and mud scent mounds.

Disease

Beaver are susceptible to tularemia, so trappers should follow the same precautions mentioned for muskrat.

Trapping Tactics

Beaver pelts are most prime in winter and early spring though like muskrats, fall caught pelts are also marketable.

Trail, bait, spillway, scent mound, and channel sets are effective in trapping in open water. Channel sets are also effective in under-ice trapping. Several kinds of bait sets using fresh twigs or other vegetation are also used under the ice. Slanted-pole sets and bait-pen sets (basically underwater cubbies) are two popular types. Most trappers prefer large body-gripping traps or strong size 3 or 4 traps for beaver. All sets should be placed in the water. When using foothold traps for beaver, submersion wires or cables equipped with one-way sliding locks must be used, unless the trap is anchored to prevent the beaver from reaching the surface. At least three feet of water is needed to submerge beaver consistently. Placing traps on or within a certain distance of dams or lodges may be illegal in some areas. In addition, some areas that do not have an open otter trapping season may require the use of offset triggers on body gripping traps. Check the regulation in the *New York Hunting and Trapping Guide* or DEC's website <http://www.dec.ny.gov>. Ask your local Environmental Conservation Officer (ECO) if in doubt about regulations.

Baits and Lures

Castoreum (the secretion of the castors) and oil glands located under the skin between the beaver's hind legs are the most frequently used beaver lures. Twigs or sections of branches from poplar, alder, willow, maple, or other trees are frequently used for bait.

River Otter (*Lontra canadensis*)

Otter are large aquatic members of the weasel family. They have the typical weasel shape, reach up to 43 inches long (including a heavy, tapered tail up to 17 inches long), and weigh up to 24 pounds. Otter are brown above and gray below with very glossy pelts. Otter fur is highly durable.

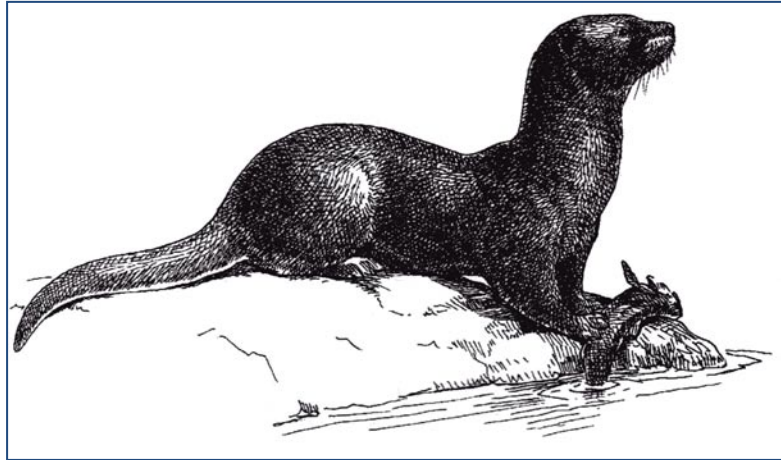

Otter have webbed feet which make them very well adapted for life in the water. Their scats are highly variable, but usually they contain masses of fish scales and bones. Otter slides and twisted tufts of grass (scent posts) are other signs of this highly prized furbearer.

Reproduction

Young otter are born in April and May, with average litter sizes of 1 to 5 young. The family group remains together for about a year. Otter dens are frequently located in bank holes, hollow logs, or abandoned beaver lodges. Like other mustelids, otter are delayed implanters.

Habitat

Otter are primarily aquatic, but they travel overland for considerable distances when moving between streams. They may visit any wetland area, including rivers, lakes, beaver ponds, streams, ponds and even small brooks within their range.

Habits

Otter are almost entirely carnivorous (flesh eating). Food items include fish, crayfish, clams, snakes, frogs, tadpoles, salamanders, and a variety of water insects. At times of food scarcity otters may prey on muskrats and small birds and eat such things as blueberries and corn. Active at any time of day or night, otter cover a large hunting area, as much as 62 linear miles or more along water courses. Otter frequently travel in pairs or family groups as they make the rounds of their hunting territories.

Even though young otter must be taught to swim, they are soon able to catch fish. They will eat the most easily caught species. Although otter reportedly take trout, they eat rough fish such as bullheads and suckers more frequently than the more elusive trout.

Otter use slides and “rolling places” along their routes. Often, tufts of grass in these areas will be twisted and scent-marked by anal gland secretions. Abundant droppings are often found in large toilet areas.

Trapping Tactics

Otter pelts are best in late fall or early winter. Like mink, otter pelts may exhibit singe if taken in late winter or spring.

Otter are extremely wary and trap shy. They are also quick and very powerful. Traps for otter must be heavy, fast, and strong. Most trappers use size 3 or 4 foothold traps or large or medium body-gripping traps. In all cases, they must be very carefully concealed. All sets should be placed in the water. Sets using foothold traps should use a submersion wire or cable with a one-way sliding lock. Care should be taken with trap placement in order to get a proper hold using foothold traps. Traps that are sprung by the otter's body will result in a trap-wise otter.

Water sets at the base of trails leading to the top of a slide are much more effective than are sets at the base of the slide. Carefully hidden sets at an otter toilet can also be productive. Bait sets are sometimes successful, but lure alone often works better for these elusive animals. Blind sets in narrow spring runs, channels, or spillways will also take otter.

Baits and Lures

Otter musk, used sparingly, is the best lure for otter. Beaver castor will also attract them. Other furbearers such as raccoon and beaver are also attracted by these lures. Some trappers use fresh, whole fish when baiting otter sets.

Opossum (*Didelphis virginiana*)

The opossum is about the size of a fat house cat. Resembling a large, shaggy, cream-to-gray colored rat with a pointed snout full of teeth, this animal can reach lengths (including tail) of 35-40 inches and weights up to about 10 pounds. With sparse, coarse, white guard hairs over black-tipped creamy underfur, the opossum has a light to dark gray body with black legs. The ears and tail are naked, and both are black at the base and lighter at the tips. Opossum pelts must be handled carefully to be worth showing to a fur buyer.

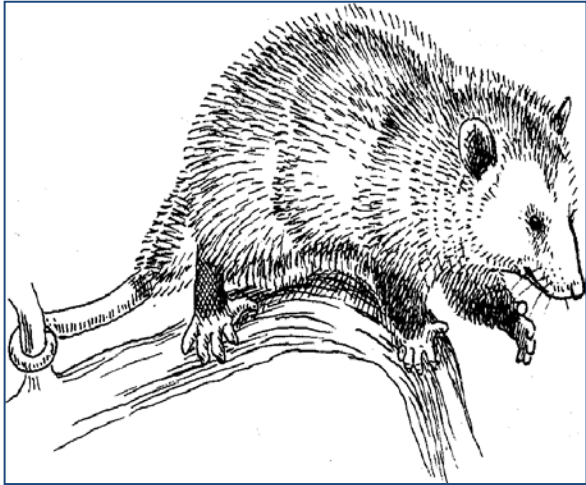

Reproduction

Opossum breed during the spring and summer, producing 1 or 2 litters each year. The young are born after a two-week gestation and up to 18 may enter the female's pouch (the opossum is the only North American marsupial). Generally only 7 to 8 young survive to leave the pouch about two months later.

Habitat

Opossum are found in brush, hedgerows, and orchards. Woodland edges, croplands, bottomlands, and even buildings are also likely areas. Dens are most often located in hollow trees, fallen logs, or burrows abandoned by woodchucks or skunks.

Habits

These rather primitive animals are mainly nocturnal. They feed on nearly anything, animal or vegetable, fresh or rotten. Opossum are not at all trap shy and may be taken in most any kind of set. Having relatively small brains dominated by the olfactory (smell) regions, they are easily attracted by sweet or foul odors. Rather slow and unwary, opossum often employ threats or play dead to avoid predation. Their tracks resemble many tiny, overlapping hand prints with a central drag mark made by the tail. The scats are variable, depending on the type of food eaten. Opossum tend to remain in a relatively restricted area.

Trapping Tactics

Opossum pelts are at their best from November to March.

Very few trappers actually set traps for opossum. Most are taken in sets made for more valuable species, particularly fox, raccoon, or mink. Dirt-hole sets and cubby sets are among the more effective opossum catchers.

Most trappers prefer size 1 or 1½ traps for opossum. Medium-sized body-gripping traps are effective where catching domestic animals is not a danger. Since opossum are not trap shy, they can be trapped effectively using box traps.

Baits and Lures

Nearly any bait or lure will attract opossum. Poultry entrails and tainted baits (e.g. rotting fish, meat, or eggs, or rank cheese) are all quite effective. Using expensive or elaborate baits or lures in trapping opossum is unnecessary.

Striped Skunk (*Mephitis mephitis*)

The striped skunk needs little introduction. Skunks are black and white, ranging from nearly all black to black with a single broad white band from crown to tail tip. Large skunk may reach



lengths up to 28 inches including about 10 inches of heavily furred tail. Weights up to 13 pounds have been recorded. Skunks have glossy guard hairs and dense underfur. Their musk glands have a very strong odor.

Reproduction

Skunk mate during the first warm weather in February and March. Litters of up to 10 young (usually about 5) are born in May after a 63-day gestation period. The young remain with the adult female until midsummer.

Dens are found under buildings, rock piles, sawmill slab piles, hollow logs, or abandoned woodchuck burrows. Winter dens are usually some form of ground burrow.

Habitat

Skunks prefer rather open country. Farmland with a mixture of brush, woodlands, pastures and cropland is ideal skunk habitat.

Habits

Skunks are mainly nocturnal, but their activity period includes both dawn and dusk. They eat large numbers of insects and small rodents as well as frogs, snakes, eggs, birds, berries, fruits, and carrion(animals found dead). Skunks become inactive during cold winter weather, but they emerge to feed during warm periods. Males wander widely during the breeding season. Skunks depend on their scent glands for defense. As a result of this effective tactic, skunks are relatively unwary and easily observed.

Diseases

Skunk are susceptible to distemper and rabies. The symptoms for these diseases are very similar. In the final stages, the animal might be indifferent to the trapper's approach, have crusty eyes, shake or quiver, and drool or foam at the mouth. Rabies can infect humans, while distemper can be caught by dogs and pets.

The trapper should avoid being bitten and always use rubber gloves when handling skunk. Any contact with skunks found dead or dying of no apparent cause should be avoided. Be sure to use the precautions mentioned later in skinning any animal. If the trapper is bitten, the animal

should be killed without damaging the brain. Wearing rubber gloves, the trapper should remove the animal from the trap and place it in a sturdy plastic bag, which is then securely fastened. The trapper should immediately wash the wound and go to a local doctor. Then, the suspected animal should be delivered to the county health office for a rabies test.

Trapping Tactics

Skunk pelts are best from November to January. Their habit of denning during cold weather means that they must be trapped most intensely during the early part of the November to January period or during warm spells.

Skunks are not trap shy, and they can be taken in a wide variety of sets. Many are caught in dirt-hole sets for fox or raccoon. Cubby sets, dirt-hole sets and sets near dens account for large numbers of skunk. Size 1 to 1½ foothold traps are most frequently used. Medium-sized body-gripping traps are effective for skunk, but they must be used very carefully to avoid catching and killing domestic animals. Box traps also may be used effectively for trapping skunk.

Baits and Lures

Fish oil and skunk musk are good skunk lures. Sweet-smelling lures such as oil of anise or honey can also draw skunk to your sets. The best lure for skunks is your favorite fox or coyote lure! Fresh or rotten flesh is good for skunk as well as opossum. Because of their broad food preferences, skunks are easily baited.

Raccoon (*Procyon lotor*)

Raccoon are heavy-bodied animals with relatively long legs, a pointed snout, and a moderately long, ringed tail. The coat has a grizzled or stippled appearance with overall color ranging from gray to chocolate brown. The black mask and the tail ringed with dark and light bands are distinctive. Raccoon reach lengths of more than 41 inches including a tail about 12 inches long. They may weigh in excess of 33 pounds. The banded

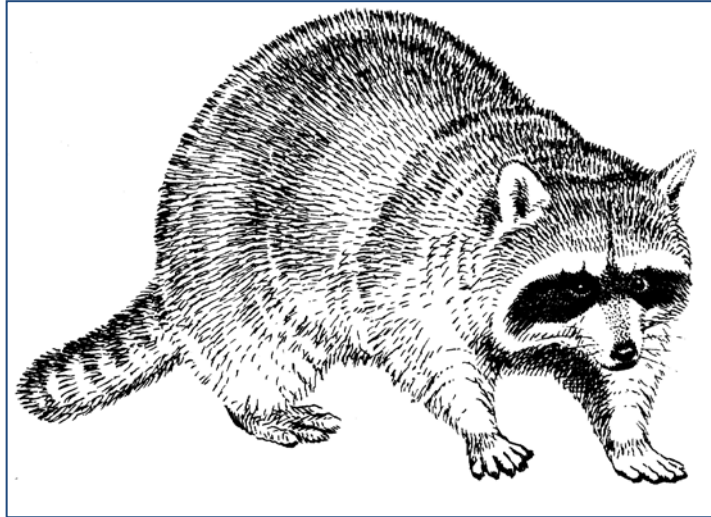

guard hairs mix with silky underfur, which ranges from pale tan to chocolate brown. Raccoon tracks resemble tiny human hand and foot prints, with the relatively long toes visible in soft surfaces.

Reproduction

The young are born in April or May after a 63-day gestation period. Litters of 2 to 7 are common, with four being average. Raccoon have one litter per year, and the young remain with the female until the fall.

Habitat

Raccoon are highly adaptable animals found over most of North America. They are often observed along wooded streams, lake shores, marshes, and swamps. They also live in upland areas where their favorite foods are found. Raccoon are well adapted to farm buildings or human dwellings, and populations within towns and suburban areas can be surprisingly high.

Raccoon den in hollow trees, logs, rocky ledges, and even in burrows made by other animals. Den trees can be recognized readily by smoothed bark, scratches, hair, and possible scats. A wise trapper will not disturb dens since they are often used year after year by the raccoons in that area. Caution should be used in setting traps near dens during the hunting season since coon dogs may go to such sites.

Habits

Raccoon eat almost anything that is available. They are efficient predators, feeding on nestling birds, eggs, fish, frogs, crayfish, mussels and insects. During the late summer and fall, their diet contains large amounts of fruits and grain. Black cherries, apples, grapes, corn, beechnuts, and acorns attract them to higher elevations.

Although raccoon are good swimmers, they confine most of their activities to the banks and shallow-water sections of lakes and streams. They will detour into water to avoid obstructions, and they use crossing logs when available. Raccoon are natural explorers with curiosity that can be used to a trapper's advantage.

Although raccoon become inactive during the winter, they are active during warm spells and thaws. Good catches can be taken throughout the winter during these periods of activity.

Disease

Raccoon are hosts to distemper and dermatophilus as well as rabies. Contact with raccoon found dead or dying without apparent cause should be avoided. Since dermatophilus can infect humans, trappers should wear rubber gloves when handling any raccoon that has flaky skin or patches of missing fur. The same precautions described for skunk should be followed (refer to the disease section under skunk for additional information).

Trapping Tactics

Raccoon pelts are best from about mid-November to January. Depending on the weather, high quality fur may be taken as late as February. Raccoon fur is quite prone to rubbing damage, singeing or springiness later in the season, and will be worth much less.

Many raccoons are taken in dirt-hole or spring-hole sets for foxes. Cubby, obstruction, and blind sets where they enter or leave the water are all good raccoon takers. Sets in spring runs or irrigation ditches often are productive. Raccoon may also be caught in leaning pole sets.

Raccoon are strong, with rather slender legs and feet. Strong sized 1 foothold traps or double jawed 1 ½ traps are used for raccoon. A good foot trap for raccoon catches them on the paw, not the wrist or leg, and is small enough to prevent the raccoon from getting its snout under the trap jaws. Foot encapsulating traps work exceptionally well for raccoon and almost eliminate unintended catches. Medium-sized body-gripping traps are good for raccoon, but they must be used very carefully to avoid catching free-ranging domestic animals. Large box traps can be quite effective in taking raccoon. Some trappers prefer to use longer trap chains with drags. However, if drags are used, they should be of sufficient size (four feet long and three inches across) and made of hardwood because these animals tend to chew at the drag.

Baits and Lures

Raccoon are attracted to a wide variety of lures, including sweet-smelling lures such as oil of anise and foul-smelling lures like fish oil. Fresh or rotten flesh, marshmallows, grape jelly, honey, fish, apples, singed (burned) corn, and mussels are all good raccoon baits. Raccoon gland lures may be very attractive to hunting dogs, so they should be used very carefully at selective set locations that dogs are not likely to frequent. Other baits and lures may be more selective.

Red Fox (*Vulpes fulva*)

The red fox resembles a small shepherd dog with a bushy tail, erect ears, pointed snout, and long legs. It is usually reddish-yellow to rusty-orange with a white-tipped tail, and black legs, feet and ears. Darker color variations known as cross and silver fox occur in some areas. Fox

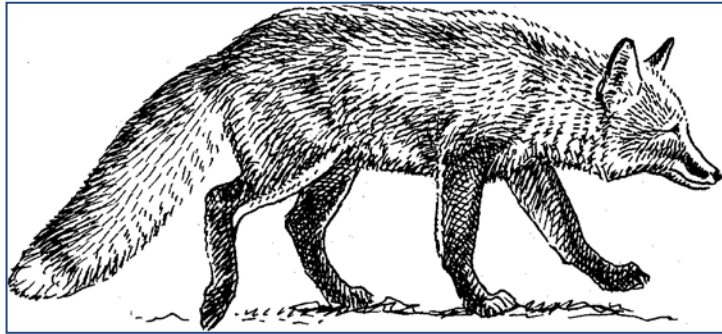

look larger than they really are. Larger specimens reach lengths of about 42 inches, including a bushy tail about three-fifths as long as the body. Maximum weights are 13 to 15 pounds. The pelt features long, glossy guard hairs with dense underfur ranging from nearly white to medium gray-brown in the reddish individuals.

Reproduction

Red fox breed in late winter with the pups born about 53 days later. Both adults may take part in rearing the litter, which usually includes 4 to 9 young. Fox have only one litter per year.

Fox den in abandoned woodchuck burrows, old slab piles, under abandoned buildings, or in small rock caves. They may dig their own dens in porous soils.

Habitat

Red fox prefer a mixture of mature, open forest and open fields. Farming country often supports excellent fox populations.

Habits

Red fox are mainly nocturnal, but they are frequently active during the day. Fond of winter sunbathing, they can often be seen on slopes with a southern exposure. Fox feed mainly on insects, rodents, some carrion, and fruits, nuts, and berries when those foods are available.

Red fox often hunt and travel along field edges, game trails, wood roads, and cleared rights-of-way. They tend to hunt along hedgerows and other strips of cover rather than the central parts of open areas. Red fox are wary and have excellent hearing, good eyesight, and finely tuned scenting abilities. They come to baits cautiously, tending to scan the area carefully from an elevated spot such as a log or ant hill before moving to a trap site.

Red fox range over a rather large area (up to one square mile), marking their travels much like domestic dogs by urinating on prominent objects.

Diseases

Red fox are susceptible to sarcoptic mange, distemper, and rabies. The precautions mentioned earlier with respect to being bitten or handling dead or dying animals also apply here. The symptoms of mange on a fox are: flaky skin, missing fur (especially on the tail), crusty patches or squinting eyes. Any fox that may have mange should be handled with caution using rubber gloves, since mange mites can infect humans and domestic animals. Be especially careful when killing the fox and try not to stand on the fox because that might expose you to the disease. If the fox has only a little mange (such as just a little flaky skin on the lower legs), the fox can be carried with rubber gloves and frozen in a plastic bag. After two weeks, the mange mites will be dead, and the fox can be skinned. If the fox has more mange, the pelt will probably be worthless, and the trapper should place the entire fox carcass in a plastic bag for disposal or bury it deep enough to prevent dogs or fox from digging it up. Many trappers also remove the trap and keep it in a plastic bag until it can be re-dyed, along with any other equipment involved. Never release a fox with mange because this disease is always fatal to red fox.

Trapping Tactics

Fox pelts are best from about November through the beginning of January. After that time, the color of the pelts may begin to fade.

Because fox are cautious and have excellent noses, traps and sets must be well hidden and free from foreign odors. Good fox trappers are careful trap handlers and set makers.

The dirt-hole set and variations of it have taken more fox than all other sets combined. Dirt-hole sets can be made more dog-proof by keeping a size 1½ coil spring trap as close to the bait-hole as possible, placing the trap so the fox comes across the jaw, and using a selective bait, fox urine, and gland lure. Because fox do not like to get wet, spring-hole sets will yield a number of animals each year. The scent post set takes advantage of a fox's home range marking system. Flat sets are also effective.

Baits and Lures

Fox urine is an excellent fox lure. Fox are also attracted to a variety of rotten flesh baits, fish oil, and skunk or mink musk. Many commercial lures are available, but many trappers make their own. A wise trapper will test the lure on a few sets before using it on the rest of the line. Red fox gland lures are also among the most effective and selective lures for fox. Baits are generally made from fresh or partially decomposed red meats. Some trappers use pieces of honeycomb or even mouse nests as bait.

Gray Fox (*Urocyon cinereoargenteus*)

The gray fox is much like the red fox in general shape and is up to 42 inches long (including the tail) with a bushy, black-tipped tail about one half the length of the body. Gray fox are generally somewhat smaller than reds with weights up to about 13 pounds. The gray's pelt is made up of mixed dark and light guard hairs over a light gray-brown underfur. The gray fox's flanks, neck, and legs are a rusty tan to orange.

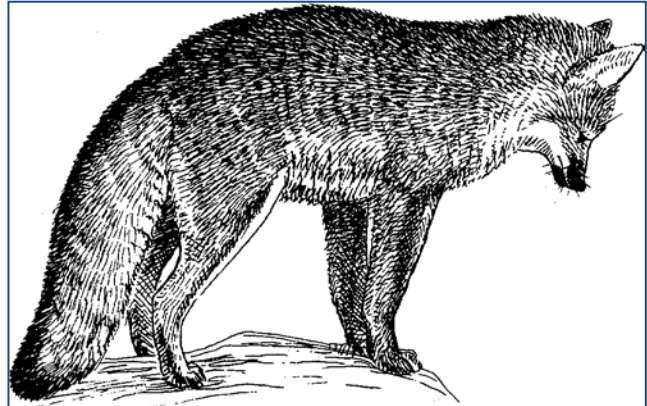

Reproduction

Gray fox breed in January and February with the young born about 50 to 60 days later. Litters of 1 to 7 young are normal. In many respects, the reproductive behavior and denning habits of gray fox are similar to those listed for red fox.

Habitat

Gray fox seem to prefer denser and moister cover than do red fox. They are found in overgrown fields, swamps, and cut-over woodland.

Habits

The gray fox is chiefly a nocturnal predator. As omnivores, gray fox consume insects, rodents, fruits, and berries. Like the red fox, the gray fox is an excellent mouser. Gray fox are quite similar to their red relatives in behavior. Gray fox and red fox are rather intolerant of one another, but their habitat preferences tend to keep them from having a great amount of interaction.

Diseases

Gray fox are susceptible to both distemper and rabies. The precautions mentioned earlier regarding being bitten or handling animals found dead or dying should be followed with gray fox as well.

Trapping Tactics

The same trapping techniques used for red fox may be used in trapping grays.

Baits and Lures

The same baits and lures used for red fox trapping can be used in trapping gray fox. Gray fox urine will attract gray fox. Commercial lures are made for gray fox, but lures made for red fox will also work quite effectively. As with red fox, gland lures are among the most effective and selective fox lures.

Coyote (*Canis latrans*)

The Eastern coyote is quite similar to a large, pale gray fox in coloration and shape. They have gray to reddish-gray fur with slightly rusty legs, feet, and ears. Large specimens may weigh up to 65 pounds with a

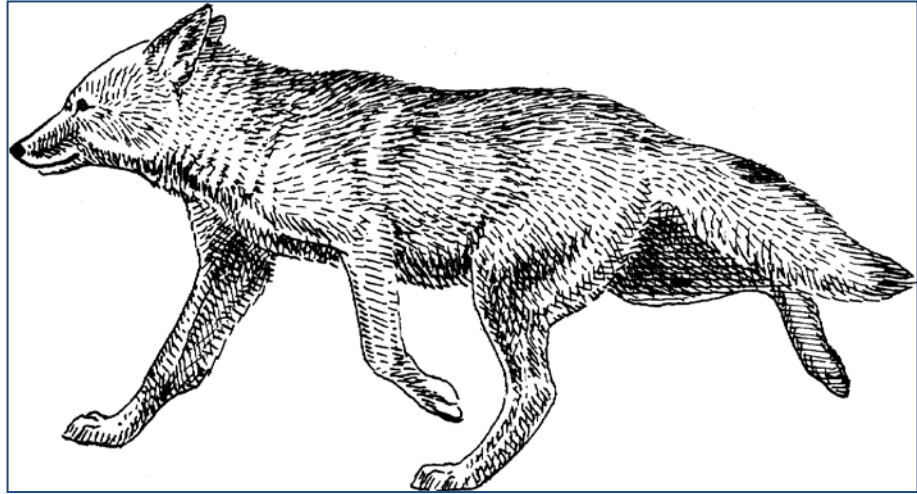

total length of about 55 inches. Average weights are between 30 and 45 pounds. The bushy tail, about 18 inches long, is carried low when the animal is running. Its ears are erect and its tail is not curled.

Reproduction

Coyote breed in January through early March, with a gestation period of about 60 days. The young are born in March, April, and May. A litter of 6 pups is common. Dens occur in loose soil, rock ledges or other good cover.

Habitat

Large areas of open woodland, brushy wetlands and rough, broken areas are the best areas to seek coyote in eastern Northern America. Occurring over much of North America, coyote have adapted to many types of habitat.

Habits

Like the other members of the dog family, coyote are mainly nocturnal predators. They eat a wide variety of both animal and plant foods. Although small mammals make up a large part of their diet, they also prey on larger animals under some conditions.

Coyote are travelers, covering a hunting route of 3 to 15 square miles depending on habitat quality. They are quite fast, reaching speeds up to about 40 miles per hour in short bursts. Sometimes hunting in pairs or family units, they have the endurance to run down larger prey. They will feed on winter-killed game or other carrion when such food is available.

Coyote are extremely wary. With excellent scenting capabilities, they can easily detect poorly treated traps or sets. Like fox, they approach new objects with caution. Because of their wide

ranging habits, coyote may not pass through a particular area for several days to weeks. Thus, sets that are not immediately successful should not be abandoned too soon.

Diseases

Coyote are susceptible to sarcoptic mange, distemper and rabies. Follow the precautions mentioned earlier for skunk and fox.

Trapping Tactics

Coyote pelts are best during the November through January period. Dirt-hole sets as well as other fox sets using size 1.75 or 2 traps are excellent fall coyote sets. When using #2 traps, use only those with thick jaws to avoid cutting the coyote's foot.

Baits and Lures

Many commercial lures are available to coyote trappers. Coyote urine and gland lures are effective. A strong-smelling oil is a good base for the lure. Mink or skunk musk can improve the cold weather performance of the lure. Baits mentioned for use with fox can also be used in trapping coyote.

Weasels: Long-tailed (*Mustela frenata*), and Short-tailed (*Mustela erminea*)

Weasels are long-bodied animals with short legs. During most of the year, they are brown with a white throat and belly. In the winter, most become all white with only a black-tipped tail. The larger, long-tailed weasel reaches a length of about 18 inches total with a tail about 6 inches long and a weight of about 13 ounces for males. Male short-tailed weasels, or *ermine*, reach a length of about 13 inches with a tail about 3 inches long and a weight of about six ounces. Females of both species are smaller than males. Weasel pelts feature short, dense underfur and abundant, short, glossy guard hairs. Color ranges from white to cream in winter specimens.

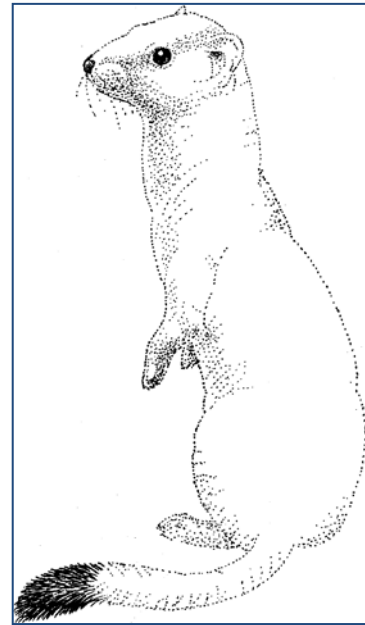

Reproduction

Weasel mate during the summer, but the young do not begin to develop until the late winter or early spring. The single yearly litters of both species are born in April or May. Litters of 4 to 8 young are normal for both species. Female long-tailed weasel breed during their first summer, but males do not mature until the next season.

Both types of weasel den in rock piles, old buildings, burrows, and hollow logs or stumps. Ermine dens are often lined with the fur of mice they have eaten.

Habitat

Weasels seem to need standing water, but they are found in almost all habitats. Brushy fields, hedgerows or stone walls are excellent places to look for signs. Weasels are tireless in hunting mainly small mammals and a few birds. Weasels are very efficient killers, using their canine teeth to pierce the skulls of their prey. Prey up to the size of rabbits is most commonly taken, but larger animals are sometimes attacked either as potential prey or in defense of young.

Where abundant prey is found, weasel will sometimes kill in large numbers. Excess prey items are sometimes hidden (cached) for later use. Weasel depredations of entire chicken flocks are a result of that instinctive killing and caching behavior. Weasels eat the entire prey. They do not merely suck the blood of their prey as many people believe.

Weasels are not wary of humans. Larger predators take weasel on occasion but these little predators, equipped with needle teeth, a shrill scream, and foul-smelling musk, are formidable defenders.

Trapping Tactics

Weasel pelts are best in late fall or winter after they have turned white. Early caught weasel that are brown or just turning to white are of less value.

Weasels are not very trap shy. Cubby sets, including weasel boxes using bloody baits, and dirt-hole sets along stone walls or logs, make good weasel sets. Size 0 and 1 foothold traps with very light pan action should be used. Small body-gripping traps, set properly, can be used effectively for weasel (household rat-sized “snap” traps can be used). Large foothold traps can be used as body-gripping traps, particularly if one jaw is propped up. Small box traps are also effective.

Baits and Lures

Weasels are interested in fresh, bloody baits. Baits need not be large; a chicken head or rabbit head is enough. Weasel musk is an excellent weasel lure that is very useful for other animals as well. Weasel scats are also good lures. Fish oil or another foul-smelling oil will attract them. A box baited with grain will attract mice that will in turn attract weasel.

Fisher (*Martes pennanti*)

Fisher are large dark-brown to black weasel-like animals. They resemble a large, short-legged black cat or a very large, heavy, dark mink. The guard hairs are frequently light-tipped, giving the animal a frosted appearance. Males reach lengths of more than 40 inches including a dark-tipped bushy tail about 14 inches long. Large males may weigh as much as 18 pounds, but females seldom reach 6 ½ pounds. Small fisher may be distinguished from large marten (*Martes americana*) by the absence of a buff throat patch.

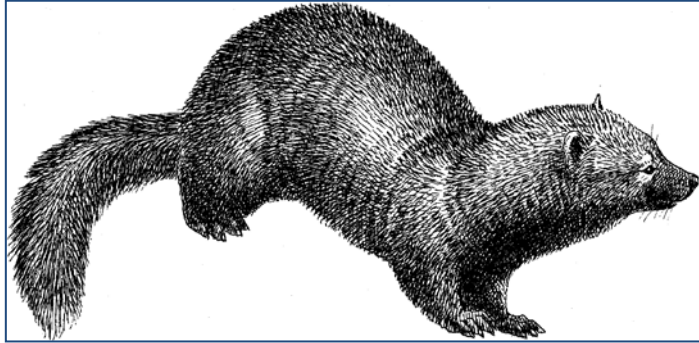

Reproduction

Fisher produce single litters of 1 to 5 young in late March or early April. They breed immediately after having their young, but they experience delayed implantation like several other members of the weasel family. The young remain with the female through the summer.

Fisher dens are usually in hollow trees with a fairly large, high opening. At times, rock crevices may also be used. Fisher frequently have several dens in their territory.

Habitat

Fisher habitat is varied, but they seem to prefer forested regions. They also occur in agricultural areas and, in recent years, suburban areas. Fisher are expanding their range into central and western New York where they were rarely or never seen even a few short years ago.

Habits

Fisher are extremely agile and active predators. Very much at home in trees, they prey on red squirrels and occasionally pine marten and raccoon. Fisher are one of the few predators that regularly prey on porcupine. They also eat berries, nuts, mice, birds, and other vertebrates. When abundant food is located, such as a dead deer, fisher will den nearby until the supply is gone.

These tireless hunters range over a large area, traveling at any time of day or night, frequently using well-established hunting trails. They are solitary except during the breeding season and when young are with the females. The fisher gives off a foul musk when disturbed.

Trapping Tactics

Fisher pelts are best in November and December.

Leaning pole sets, cubby sets and dirt-hole sets are generally considered best for fisher, and size 1½ or 2 foothold traps are adequate. Medium-sized, body-gripping traps are effective for fisher, but they must be used cautiously to avoid killing domestic animals. Box traps can also be used effectively.

Baits and Lures

Fisher musk, fish oil, beaver castor, and skunk essence are attractive to fisher whether used alone or in combinations. These lures can be used with bait such as fresh beaver flesh to increase the drawing power of the bait. Several commercial lures are also available.

Bobcat (*Lynx rufus*)

Reaching lengths to about 36 inches with a tail about five inches long and a weight of up to about 33 pounds, bobcats resemble very large, short-tailed housecats. Bobcats are tawny to rusty with black spots, especially on their light undersides.

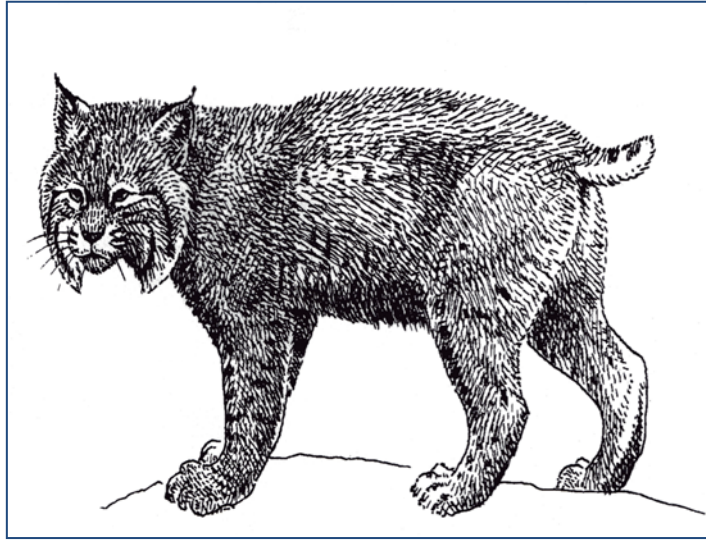

Reproduction

Bobcat may breed at any time of the year, but spring mating is most common. A litter of 2 to 4 young are born about 50 days later.

Bobcat dens are usually in rock crevices, hollow logs, or dense windfalls.

Habitat

In eastern North America, bobcat are usually found in brush lots, heavily forested areas or in dense woodland swamps. They also occur in some agricultural areas. Like fisher, bobcat have been expanding their range into central and western New York.

Habits

Bobcats are primarily nocturnal, solitary predators. Small mammals, birds, and occasional larger animals like beaver or deer are hunted by stalking. Rodents and rabbits are the most frequent prey. Large prey animals and fresh carrion are usually covered between feeding periods.

Bobcat wander widely within a moderately large home area visiting traditional trails around rocky ledges, stream banks, beaver ponds, or bogs. They also follow old logging roads and deer trails.

Trapping Tactics

Bobcats pelts are at their best from late November to February.

Dirt-hole sets, cubby sets, and leaning pole sets will take bobcat. Most trappers prefer size 2 and 3 foothold traps (with a jaw spread of five and three-quarters inches or less) for bobcat.

Baits and Lures

Lures can be more effective than are baits for bobcat. Fish oil, bobcat anal glands or urine, oil of catnip, skunk essence, and beaver castor are all used as bobcat lure ingredients. Several commercial lures and baits are available.

American (Pine) Marten (*Martes americana*)

Marten are medium-sized, light- to dark-brown weasel-like animals. Buff to yellow-orange fur covers the underside of the throat and the upper chest, making them easy to distinguish from similar species. Males may be up to 35 inches long, reaching weights of up to 3 pounds. Females are smaller, averaging 22 inches long and weighing about 2 pounds.



Reproduction

Marten produce single litters of 1 to 5 (average 2 to 3) young annually. The young are born in late March or early April. The adults breed soon after the young are born, but they experience delayed implantation like several other members of the weasel family.

Marten dens are usually in hollow logs or trees, but occasionally they may use a ground burrow.

Habitat

Marten habitat varies, but they seem to prefer heavily forested areas.

Habits

Marten are extremely agile and active predators, spending much time in the tree tops. They feed on chipmunks, squirrels, mice, rabbits, shrews, moles, small birds, berries and nuts. Amphibians, reptiles, and insects are also eaten occasionally.

Although they are often considered nocturnal, marten may be active at any time of the day. They are solitary except during the breeding season and while young are with the female. Marten are active throughout the year, but they may den during periods of severe weather. They may give off a foul musk when disturbed.

Trapping Tactics

Marten pelts are most prime at the same time as fisher, in November and December.

In general, marten sets are similar to those used for fisher. Cubby sets and leaning pole sets are most frequently used. Size 1½ foothold traps and medium or small (double spring) body-gripping traps may be used effectively. Box traps also can be useful in trapping marten.

Baits and Lures

Marten musk and urine, fish oil, skunk essence, jam, sardines, and beaver castor are attractive to marten. A good lure can increase the drawing power of baited sets, particularly during cold weather.

Chapter 10 Common Water Sets

Many new trappers start by trapping semi-aquatic furbearers such as muskrat and mink. Raccoon, which are less aquatic, can also be taken in water sets. The sets presented in this chapter are useful for those species as well as for beaver and otter. Body-gripping traps or submersion sets should be used whenever possible for water trapping. Where body-gripping traps are not useable and the water is not deep enough to submerge muskrat and mink, always use guarded foothold traps to prevent animals from escaping. Be certain your traps are anchored or staked solidly enough to hold the strongest animal you may catch, in this case, beaver or otter.

The depth of water that covers a trap is dependent on the species being targeted. For muskrat, mink, otter and raccoon, one to two inches of water covering the trap is usually sufficient. For beaver, the trap may need to be placed in much deeper water, especially if the trapper is trying to catch the beaver by a back foot.

Submersion sets for muskrat and mink need not be elaborate. Stake the trap in deep water (12 to 18 inches) or use a sliding wire or cable to let the animal reach deep water. Make sure the trap is firmly anchored since raccoon are often taken in sets made for muskrat and mink. Beaver and otter require the use of a one-way sliding lock on a strong wire or cable. Sliding locks can be made using angle iron, bent washers, or double swivel bodies. Commercial “drowning locks” and cables are also available.

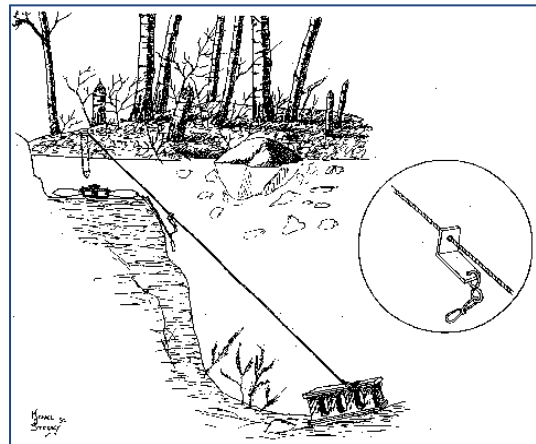

Feedbed Sets

Muskrats create feedbeds which actually are piles of food cuttings. These piles can be easily distinguished from muskrat lodges because the feedbed is barely above the waters surface whereas lodges are several feet in height. Muskrats are caught at these feedbeds by foothold traps set in 1 to 2 inches of water in front of the pile. The trap should be attached to a submersion wire if the water is more than a foot deep. If the water is less than 1 foot deep, use a guarded foothold trap.

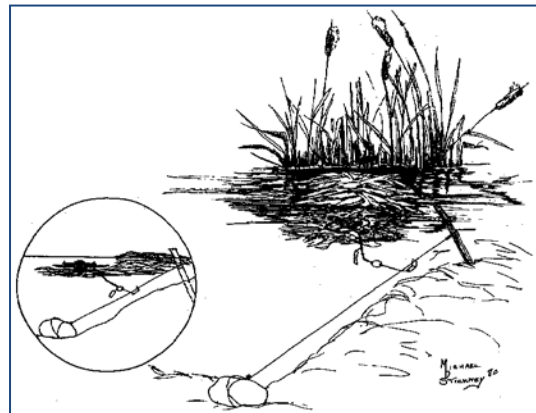

Float Set

Muskrat and some other aquatic animals tend to climb up on floating logs or other surface objects. The trapper can take advantage of that behavior by using existing floating logs or by building a small floating platform and concealing traps where the animal will trigger them.

Several designs are illustrated. When such sets are used in a foot or more of water, the weight of the trap will submerge the muskrat. The trapper can avoid catching waterfowl by placing a crossed pair of branch hoops about 6 inches over the float as illustrated. Consider using only one trap at each float set to lessen the chance of birds of prey being captured accidentally if attracted by a catch.

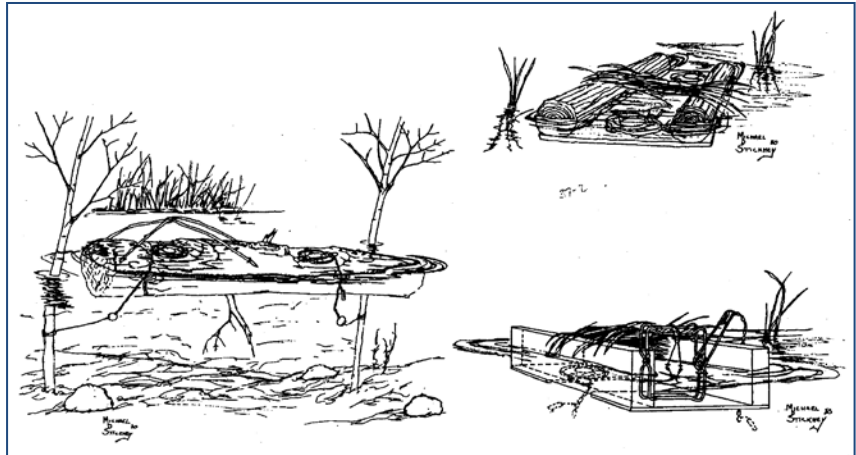

Channel Set

Most semi-aquatic furbearers follow well-defined trails under water. Since the animal commonly goes through restricted spaces, body-gripping traps of adequate sizes are ideal for trapping these channels. Where the channel is too wide to guide the animal into the trap, it may be fenced or otherwise constricted using brush and similar natural materials. The trap is usually more effective if placed at the bottom of the channel. Mink will be taken occasionally in channel sets for muskrat. Beaver are effectively trapped in their channels, and otter may be caught in those sets as well.

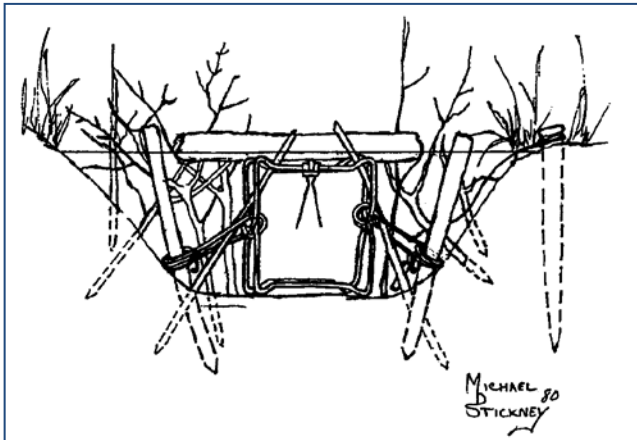

Bank Hole Set

Muskrat dig bank dens along streams, rivers, ponds and lakes. These dens may look like small underwater woodchuck burrows. Foothold traps can be used to capture muskrat at bank den entrances,

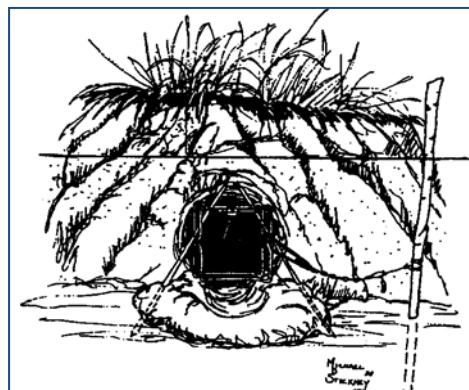

but body-gripping traps are usually easier to use at the set location. No bait or lure is needed.

Trail Sets

Many water animals travel the same trail each time they pass over a given spot. Blind, unbaited sets in these trails are often very productive. They are also selective if properly placed. Muskrats can be taken by concealing a foothold trap underwater where their trails are evident. The trap should be placed so that the animal's foot comes between rather than over the jaws as it

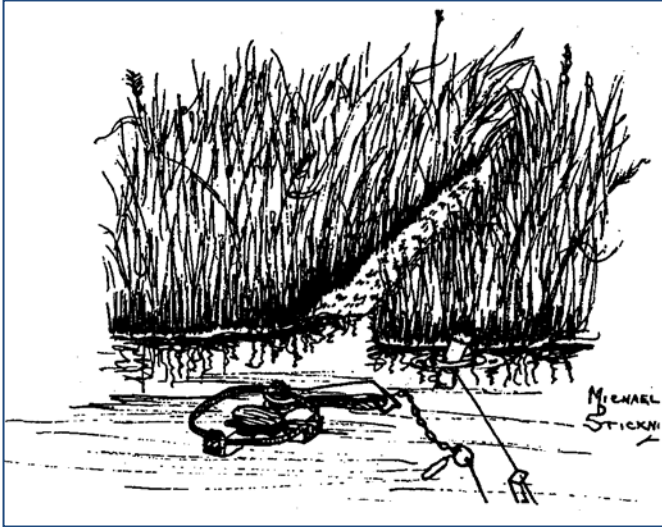

approaches. Muskrat lure can be placed above the trap to enhance the set, but it is not necessary. Be sure to follow the precautions for submerging the animal or use a guarded trap or small body-gripping trap if deep water is not available.

Beaver and otter can be taken at trails using a strong foothold trap carefully concealed in 3 to 4 inches of water at the base of the trail. The use of a sliding lock and submerging wire is essential for beaver and otter trapping.

Pocket Set

The pocket set will take mink, muskrat, and raccoon quite effectively. An upward-sloping hole is dug into the stream bank such that the back of the hole is above the waterline and the base of the hole at the entrance is 2 to 3 inches below the waterline. For mink and muskrat, the hole should be about 6 inches in diameter and 12 inches deep. Pockets for raccoon can be made as much as twice that size, but it is not necessary. For mink and muskrat, either body-gripping or

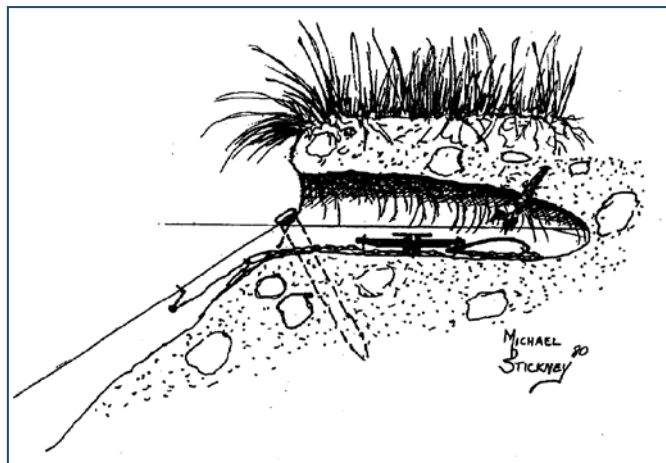

foothold traps of appropriate size may be used. Foothold traps should be set to ensure submersion of the trapped animal. For raccoon, appropriately sized foothold traps should be used. The pocket is baited with fish or a honey-based bait and an appropriate lure. In areas where free-ranging dogs may occur, the trapper should avoid meat baits and raccoon gland lures. Locating the set under low-hanging cover, like branches or exposed tree roots, and keeping the trap well inside the pocket is also helpful in keeping dogs out of these sets. Muskrat

musk and beaver castor are excellent lures for pocket sets. Traps at pocket sets can either be placed within the hole as shown in the accompanying drawing or, more effectively, at the entrance but outside the hole. And remember to anchor your traps solidly.

Spring Run Set

Spring runs or small streams entering larger bodies of water are natural channels for muskrat, mink, and otter. Because raccoon frequently move along or across them, at the edge of the larger body of water, spring run sets should be made secure for raccoon as well as mink and muskrat. Foothold traps of appropriate size and submerging wires should be used. In some cases, appropriately sized body-gripping traps also may be used effectively, provided they are set in the water.



Obstruction Set

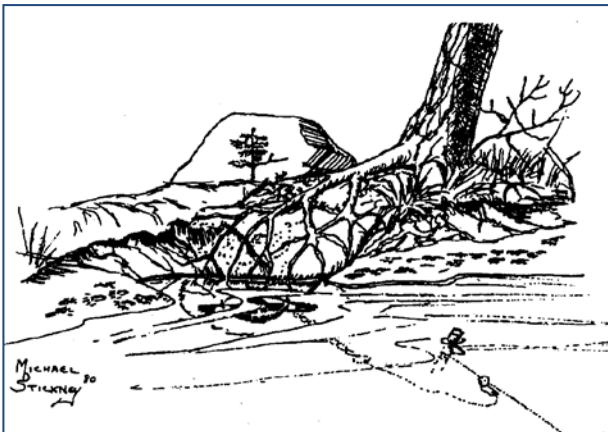

Another type of trail set makes use of the way furbearers behave when they encounter an obstruction. Raccoon and mink tend to enter the water at the same place each time they encounter an obstruction on the bank, often forming a visible trail. Water sets at these points can be quite productive. The trap should be well bedded and may be covered with water-soaked leaves or mud. A submersion set should be used. No bait or lure is needed.

Scent Mound Set

Beaver create mud mounds and mark them with castor, much like fox and coyote mark prominent objects with urine. Use a well-concealed trap in 3 to 4 inches of water, with a sliding lock submersion wire. In situations where there is no risk of domestic animals encountering the trap, large body-grip traps may also be used. Placing the trap at either a natural or artificial

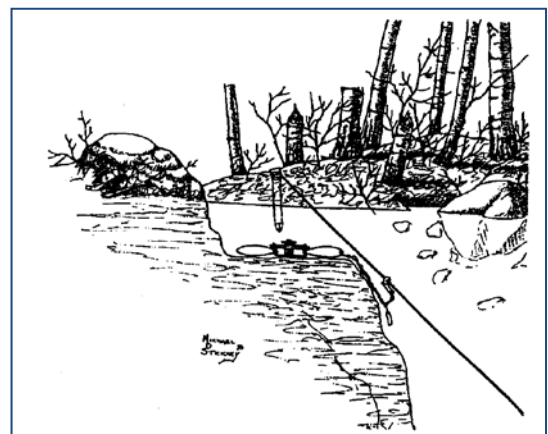

scent mound is a common set for beaver in open water trapping. Trappers who create artificial scent mounds often use commercially available castor-based lures or homemade lures using the castors of previously caught beaver from other colonies.

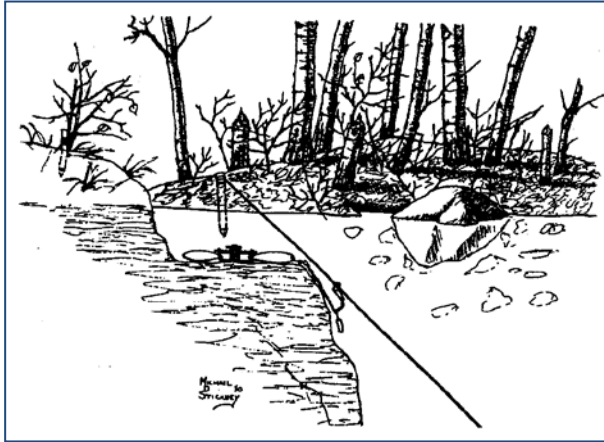

A variation of the scent mound set is the open-water baited beaver set. Instead of using a scent mound to attract beaver, the trapper places bait such as fresh poplar sticks to entice the animal into or over the trap. The same traps mentioned for scent mound sets may be used (follow the same precautions to avoid trapping domestic animals when using large body-grip traps). The addition of a good lure may be helpful but is often unnecessary with a well-constructed bait set.

Spillway Set

Beaver, muskrat, and otter often use the same path or spillway to cross a beaver dam. Where legal, traps can be set in such places (refer to regulations in the *New York State Hunting and Trapping Guide* for specifics on setting on or near a beaver dam). Foothold traps should be set as described previously for trail sets. If body-gripping traps are used, they must be set in the water (generally below the dam in the spillway).

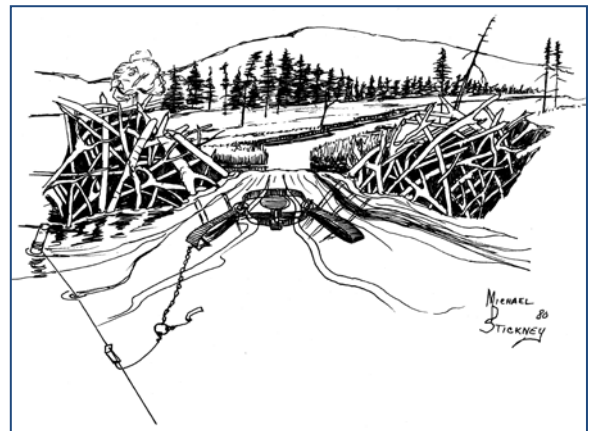
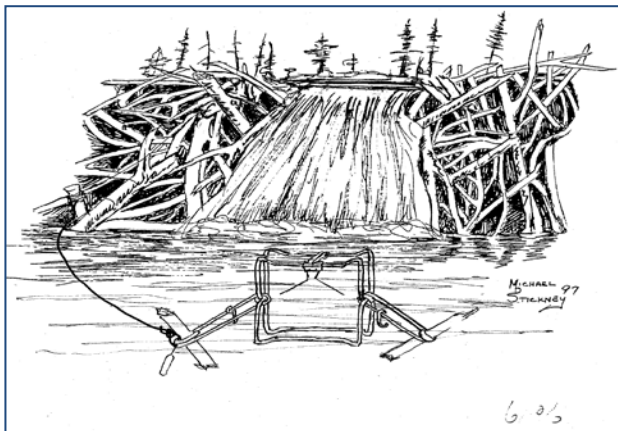

Under- Ice Baited Beaver Set

Many beaver are trapped under the ice by using fresh bait such as poplar. Either foothold or body-gripping traps may be used. A hole is chopped into the ice near where the beaver lives or feeds, but

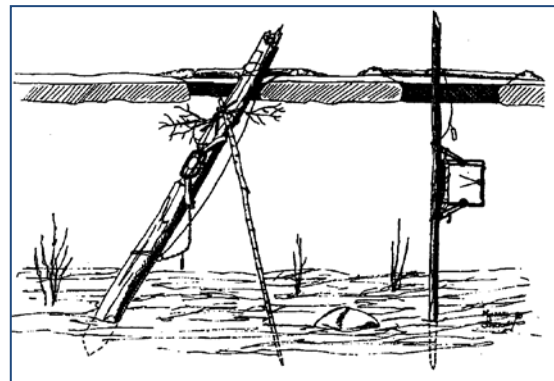

not within 15 feet of a beaver den or house. Then a trap and bait are fastened on a dry pole, placed through the hole in the ice, and pushed deep into the muddy bottom. The top of the pole is anchored above the ice to a cross pole that cannot be pulled through the hole in the ice. If a foothold trap is used, it should be secured to the lower portion of the pole in a manner that prevents the beaver from reaching the hole in the ice and getting air, thus killing the beaver faster. Where stable ice conditions occur, under-ice baited sets are an excellent and highly selective method for trapping beaver.

Otter Toilet Set



Otters create and regularly use certain spots for toilets. These spots are generally near the water and contain numerous piles of fish scales and bones. A foothold trap can be set in 3 to 4 inches of water where the otter leaves the water to visit the toilet. It should be attached with a one-way sliding lock to a submersion wire that leads to deep water. Provided domestic animals cannot encounter the trap and the trap can be set in water, body-gripping traps may also be used.

Chapter 11 Land Sets

A precautionary note on the use of body-grip traps on land.

Body-gripping traps are designed to kill the animals they catch. Due to this, trappers must exercise extreme caution when using them on land to avoid the unintentional capture of domestic animals or other wildlife species. Beginning trappers should seek help from an experienced trapper when using body-gripping traps on land for the first time.

As a result of several incidents involving the unintentional capture of dogs, the Department of Environmental Conservation enacted strict regulations governing the use of body-grip traps on land. These regulations are very specific and complex, therefore, descriptions of the specifications of the regulation, with graphics, can be found in Appendix 4. If after reviewing these materials, you still have questions, contact your local Environmental Conservation Officer, Regional Wildlife office, or talk to a trapper experienced in the use of body-grip traps on land for clarification.

Trappers should further note that it is illegal to use body-grip traps larger than 7 ½ inches (“220” sized) on land. Learn how to properly measure the size of body-grip traps to be sure your equipment is legal to use. Your adherence to these regulations and responsible use of these traps will help to ensure their continued use on the trap line.

Cubby Sets

Cubbies can be used effectively for land species that will enter a closed space. They work well for weasel, skunk, raccoon, opossum, fisher, marten, mink and even bobcat. They are not effective for fox or coyote. Cubbies are containers or boxes that prevent the animal from approaching a bait or lure from any side except that guarded by the trap. Hollow logs or trees, stumps and drain tiles are natural cubbies. A trapper may construct others of sticks, logs, bark or rocks. Cubby sets can be made using body-gripping or foothold traps. If using body-grip traps, set them only in the manner prescribed in the regulations found in Appendix 4.

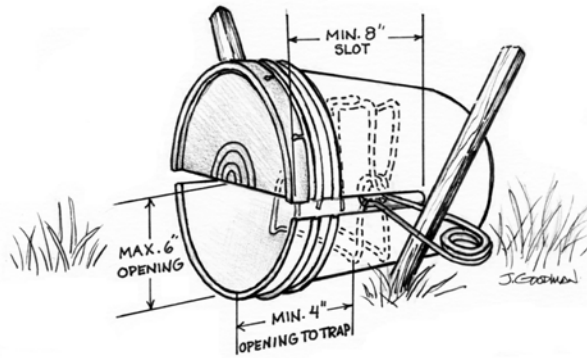
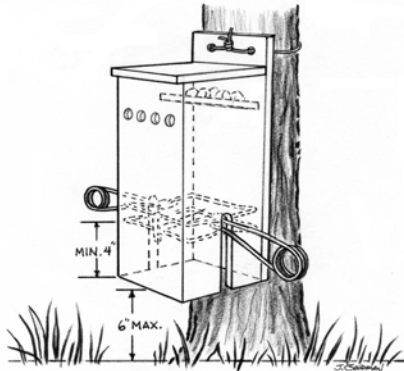
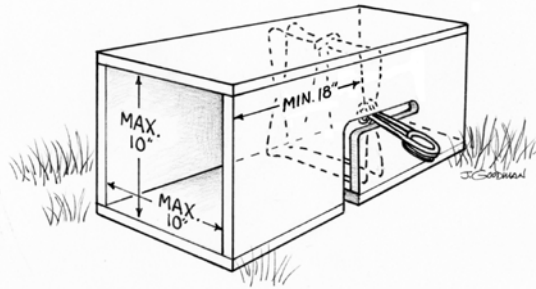
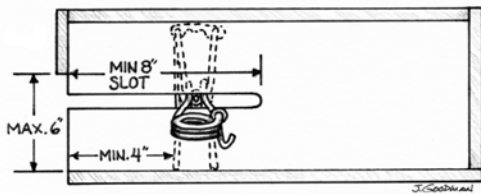

Weasel Box Set

A small wooden box with holes cut in the ends is an excellent weasel cubby. The holes should be about 2½ to 3 inches in diameter. The box can be baited with grain (to attract mice), bloody bait, weasel scent, or a combination of those baits. Solidly staked under-spring or long spring traps in sizes 0 to 1 ½ with a very light pan tension are appropriate. Small body-grip traps may also be used. A large rock placed on top of the box will prevent other animals from getting into the set.

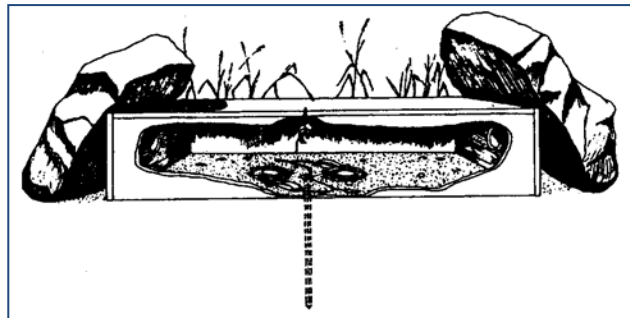

Raccoon Boxes

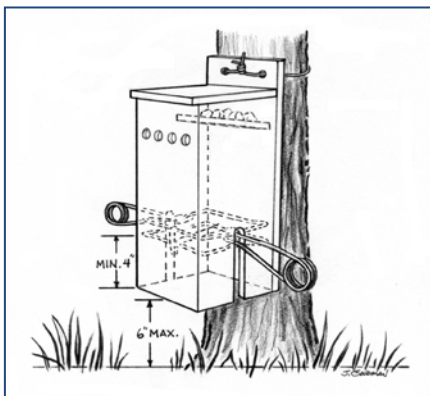

Another type of cubby can be used effectively for raccoon. An open-ended wooden box about 9 x 9 inches, with its opening guarded by a medium-sized body-gripping trap, is placed vertically on a tree no more than 6 inches above the ground (see Appendix 4). The cubby can be held in place by staples or light wire. Bending the springs puts tension against the notches holding the trap in place. The trap must be at least 4 inches up inside the box. Baits of

fish, beaver castor, or honey with anise can be used. This set can take domestic cats, so it should not be used where there is danger of catching them. Be sure the box is securely fastened to a tree.

Box or Cage Traps

Box traps are self-contained cubbies. Thus they can be used effectively for the animals that will enter an enclosed space. In many cases, carefully covering the box trap will make the set more effective and also may help in hiding it from thieves. In most instances, the bait should be placed behind the treadle or trigger.



Single-door traps may work better than those with double doors, particularly for raccoon, marten, and fisher. Though expensive, box or cage traps are good options in areas where there is risk of an unintentional capture as the animal will be alive and can be released.

Scent Post Set

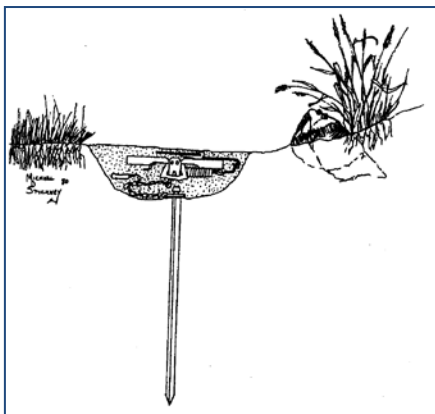

Like domestic dogs, coyote and fox urinate on prominent objects along their lines of travel. Trappers can take advantage of that habit to catch these furbearers. Raccoon, skunk and opossum also may investigate scent post sets for fox. A small prominent object, like a protruding stone, grass tuft, or stick serves as the post. A liberal amount of fox urine and a few drops of gland lure are placed on it. The trap is carefully bedded and concealed a few inches away from the post, so that the animal will step on it while urinating. Traps should be covered and staked as with the dirt-hole set.

Flat Set

The flat set is quite similar to the scent post set. No bait hole or post is used, but the set is lured and liberally sprayed with fox urine. The flat set is an excellent choice where fox are acting shy of dirt-hole sets.

Dirt-Hole Sets

The dirt-hole set is an extremely good producer for nearly all predatory furbearers. Making dirt-hole sets for fox and coyote is challenging, and the instructions below are written for that type of set. Site selection is all important. The set should be made in a relatively open spot where visibility is good on all sides. Naturally, fox activity should be evident in the area.

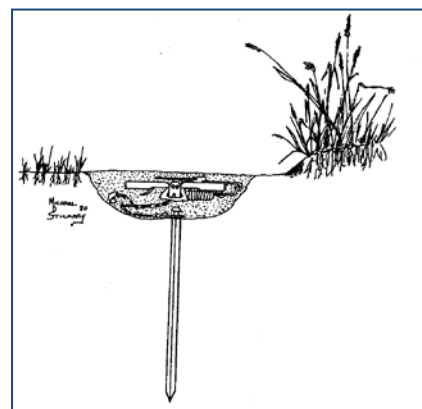

After selecting the site, all equipment should be prepared, and the trapper should go directly to the spot. The bait hole should be dug near a clump of weeds, a rock, a small stump, or some similar backstop. It should be about 2-1/2 to 4 inches in diameter, 6 to 8 inches deep, sloping back about 60 degrees under the backstop. All dirt removed should be placed in the sifter.



Next, a triangle of sod about 8 to 10 inches on each side is removed in front of the hole. The point of the triangle should touch the hole, giving it the appearance of a fox-dug food cache. Dirt is removed from the triangle until the trap bed is sufficient for the trap to sit below the surface.

The trap is staked so that the stake and chain will be directly under it. After the stake is driven, pull hard on the chain. **If the stake moves, the trap is inadequately anchored.** Either add an additional stake, use an earth anchor, or move the set to a location where the stake will hold adequately. Cover the stake



and excess chain with a smooth layer of earth and bed the trap carefully but firmly. The trap should not rock or shift position. In wet or freezing weather, the trap should be bedded in dry sand, ant-hill dirt, or an anti-freeze may be used. Anti-freezes which are used include salt, calcium chloride, or commercial products. When using salt or calcium chloride, make sure traps are waxed to prevent rusting.

After adding the pan cover (if used), the trapper can cover the trap with sifted soil. The soil should be level, and the trap should be buried about 1/2 inch below the surface. The trap pan should be as close to the front of the bait hole as possible.



The set is completed by placing bait in the hole and adding a few drops of lure on the backstop (often a clump of grass or stump). Fox urine is then squirted behind the hole and the trapper leaves the area as undisturbed as possible.



For coyote and bobcat, the set is made a bit larger with larger traps and the trapper may wish to position the trap farther away from the hole. When trapping strictly for raccoon, raccoon lure may be used, and fox urine is unnecessary. Skunk and opossum may also be caught in these sets. Mink are sometimes taken at dirt-hole sets. They are also effective for fisher and marten.

Spring-Hole Set

The spring-hole set is effective for raccoon and fox. It takes advantage of the habit of the fox to avoid wet feet. A site with permanent water (preferably a non-freezing spring), several inches deep and 3' or more wide is selected. A large piece of moss-covered rock or sod is placed about 12" out from the

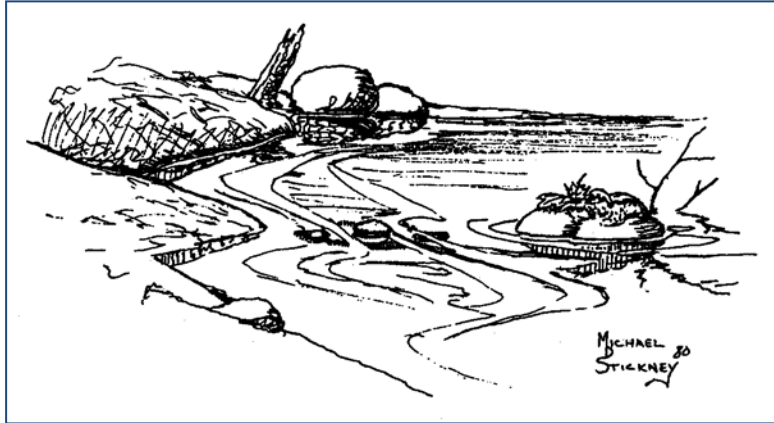

bank. A second, smaller rock or sod, fitted to the inside of the trap jaws, is placed about halfway from the bank edge to the bait sod. The trap and drag should be concealed below the surface, but the “stepping stone” should be above the water and stable on the pan. The trap should be adjusted so that the pan is level and rather stiff in action. Bait and lure placed on the bait sod should be carefully hidden to prevent birds from stealing the bait or getting into the set. Spring-hole sets work best in late fall and winter in most areas.

Leaning-Pole or Running Pole Set

A second “dog-resistant” set for raccoon, fisher, marten, and gray fox is the leaning-pole set. A bait (fish or beaver or raccoon meat are good choices) and lure (generally something with skunk essence in it) are placed at the top end of the pole. The trap is placed lower on the pole, but at least 4' above the ground (see Appendix 4). Medium body-gripping traps can be stapled (the jaw nearest the bait) to the pole or placed on a trap holder. You may wish to move the trigger to the side to prevent small mammals such as squirrels from

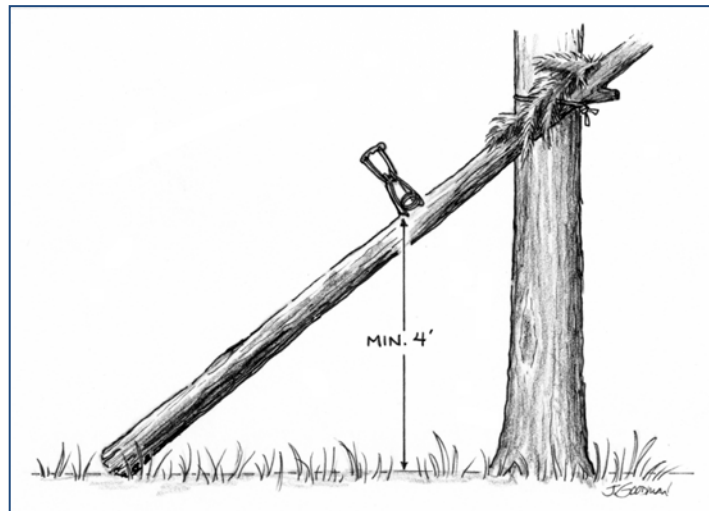

springing the trap. A pan-type trigger is commercially available, and very useful in this set. The trapper must be sure the animal will not be suspended above the ground by extending the

anchoring system (typically a chain, cable, and/or wire) enough to allow the captured animal to fall to the ground or by directly and firmly attaching the trap to the tree or pole.

Cover the bait such that it is not visible from above to avoid the risk of attracting birds to the set. This set can catch domestic cats so the trapper should avoid using it where they may be found.

The sets described in this chapter cover the basics for land trapping. Variations on these sets abound. Trappers can learn more about other land sets by reading trapping magazines and books, tagging along with experienced trappers, or by watching demonstrations at trappers conventions and rendezvous.

Chapter 12 Running a Trapline

Trapping is a serious responsibility that takes hard work and dedication on the part of the trapper. Once the traps are set, the trapper cannot take a day off. Remember, by law, traps must be checked daily (48 hours in some areas) and besides, it's the ethical thing to do. Trapping with a partner can help to alleviate the demands of running the trapline by allowing you to alternate trap check days.

Don't bite off more than you can chew. If you only have to time to effectively operate 10 traps, don't set 12! If you are only capable of skinning and fleshing two or three animals each night, don't set so many traps that you end up catching five or six. Finally, don't over trap an area. Your pre-season scouting will give you a sense of the numbers of your intended animals on your trap line. Setting goals for each species can be fun and a big aid in keeping you focused and energized, but you must be realistic when establishing your goals. If you only have access to one small pond, hoping to catch 100 muskrats is unrealistic.

Obtain Permission

If you're planning to trap on private lands, getting landowner permission is a must. This is best done well in advance of the trapping season during the spring and summer months. Part of the process is marketing yourself, so dress neatly when asking for permission. Be polite even if you are denied access to a property.

If you are granted permission to access the property, ask the landowner about possible problems with certain furbearers such as beavers flooding fields or access roads, raccoons damaging corn crops, or coyotes and fox preying on livestock. Ask if neighboring properties are also experiencing these problems. Make certain you know which portions of the property you have permission to access and see if there are periods during the season when your permission may not apply.

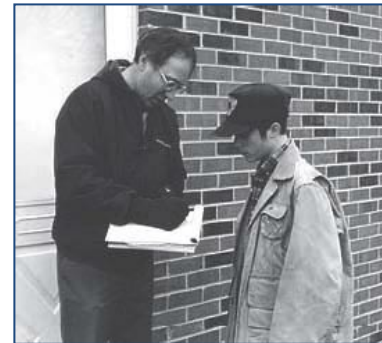

Work out an agreed-upon schedule with the landowner for pre-season scouting and actual trapping. Let the landowner know which vehicle you will be driving and provide your contact information so the landowner can alert you to changes or maybe even if your traps have made a catch. Finally, contact the landowner again shortly before the season begins to check for things that may require an adjustment to your agreement.

Pre-season Scouting



After you have obtained landowner permission, pre-season scouting should be completed. Taking a tour of your trapping properties will give you a sense of what animals are available for you to trap and how many you can reasonably expect to catch. Taking the time now to identify primary travel areas of your intended species will save you countless hours on the trapline while you are setting traps.

The Checking Schedule

After the traps are set, the trapper waits in eager anticipation. Since most furbearers are active at night, the responsible trapper checks traps early each morning for several important reasons:

- The time an animal is held in a trap is kept to a minimum which could reduce any stress on the part of the trapped animal.
- A trapped animal is less likely to escape.
- A trapped animal is less likely to be stolen.

If a trapper is going to school, he or she should try to quickly check all of their sets in the morning before school and remove their catch. After school, revisit the trapline and reset traps that had a catch in the morning, scout for new sets and try to recheck as many other sets as time allows. This checking schedule is good for all three reasons listed above, plus it gives advantages over someone who just checked traps once a day. The trapper who checks traps before and after school will have more time to make better and more selective sets, which should result in a larger catch of intended furbearers and reduce the chance of catching unintended animals.



Before checking a trapline, the trapper should have the necessary equipment and knowledge to properly handle any captured animal. If using foothold traps on land, the trapper should have the proper equipment for killing a intended animal and for releasing unintended animals, and the knowledge to properly use these tools.

When actually checking a trap, the trapper should always approach close enough to the set to see the trap. The smart trapper also checks the bait, the trap covering (if it is a land set) and especially the area around the set for signs of a visit. A trapper can often learn a lot by studying such visits. If a dog, cat, or human is visiting the set, the trapper would probably want to move the trap to a new location. If a fox visited the set, the trapper might want to use another type of

bait or lure. These tips can be valuable to a beginning trapper to reduce the catch of unintended animals and increase the catch of intended animals.

Releasing Unintended Animals

Occasionally, unintended animals are captured. When this occurs, the trapper must release the creature quickly but without danger to himself. There are several different methods of releasing these unintended animals. A catchpole can be placed around the animal's neck to control it while the trap is removed. Make the loop snug but be careful not to choke the animal. One suggestion to avoid this problem is to position the loop so that a free front leg and shoulder is included in the loop. Firm pressure will keep the animal from biting you while you release its leg from the trap. A sturdy forked stick may



also be used in place of the loop to hold the animal's head securely while it is being released. Some trappers use a large piece of fabric (such as a heavy square of canvas or a heavy coat, etc.) to place over the trapped animal, leaving the trapped foot exposed. Then the fabric is held down along the trapped limb by kneeling or standing on the fabric (of course, being careful not to step on the animal). Finally, the trap is quickly removed and the animal is released. As mentioned previously in Chapter 6, a board with a V-notch cut into it may also be used to release unintended and other unwanted animals.

Releasing animals is always easier with a partner. Young trappers should always get help before releasing unintended animals.

The trapper should carefully evaluate the set type and placement to avoid catching domestic animals. The ethics of trapping insist on this, and it is always wise to place sets where no dogs or cats are seen close by. However, accidents can still happen and if you do catch a dog or cat, you should make every effort to contact the owner of the pet to make them aware of the situation.

By learning proper techniques and methods trappers can become extremely selective and the capture of unintended animals can virtually be eliminated.

Killing Trapped Animals

Editor's Note: This section was written to introduce the reader to methods of killing furbearers. No attempt has been made to make this seem easier, nicer, or more difficult than it really is. If the reader finds this section disturbing, then perhaps the reader should not attempt to trap land furbearers. The reader could use submersion sets and body-gripping traps for water furbearers until he or she felt that they could kill a furbearer by striking it on the head or until they were old enough to use a firearm. Just as trapping is not for everyone, land trapping may not be for every trapper.

New or young trappers should only pursue animals which they can easily and safely kill. If you catch any animal that you cannot safely handle, GET HELP. Asking for the help of an experienced trapper or parent is the smart thing to do. It will help you harvest the animal humanely, prevent wounding it, and avoid risking injury.

There are several humane ways to kill trapped furbearers. It should be done as quickly and humanely as possible while not endangering yourself with the animal's teeth, claws, or scent glands. The best way to kill a trapped furbearer depends on several different factors such as the species of furbearer, the type of trap used, and the trapper. The use of body-gripping traps and submersion sets can keep the need for killing water animals to a minimum. If a live furbearer is encountered, it may be quickly and humanely killed by striking sharply on the head or by shooting.

Shooting is a very effective way to kill furbearers if the trapper is old enough to legally carry a firearm. A well placed shot using a .22 rim-fire cartridge aimed to pass through the front of the brain into the body of the animal is fatal and quick. Opossum have a very small brain placed low in the head, so they should be shot at the base of the ear or down through the midline of the skull. Skunk may be prevented from spraying their musk if they are shot through the lungs in the chest region. Head and spine shots usually result in their releasing musk. Furbearers held in both foothold and cage traps may be safely shot.

Always be careful that the bullet does not strike the ground, a rock, or the trap and ricochet. If more than one person is present, they should all stand behind the shooter.

If using a firearm to dispatch furbearers is not an option for you, another method will have to be used. Most furbearers can be quickly and humanely killed by first sharply striking them at the base of the skull with a heavy wooden or metal tool. It is highly recommended that the animal be struck two times, once to render it unconscious and again to render it either dead or comatose. To ensure death, pin the head with one foot and stand on the chest (area near the heart) of the animal with the other foot for several minutes. The trapper should never attempt to stand on a conscious animal and should not step off of an unconscious animal until it is dead. To be sure the furbearer is dead, the trapper can touch the eye or mouth of the animal with the striking tool and watch for any reaction. If there is no reaction and then if the trapper does not detect any breathing or heart beats, the animal can be assumed dead. The trapper must be especially careful with opossum because it is often difficult to detect its reactions, breathing or heart beats. The larger furbearers such as raccoon, coyote, and bobcat may be too large for some beginners to safely kill using this method. If this is the case, seek assistance in killing larger animals.

Skunk should be approached quietly with the wind blowing from you to the skunk. Many trappers talk softly to the skunk and stop approaching when it raises its tail. When close enough, strike the skunk as mentioned earlier. However, its tail will twitch and the skunk will spray its

musk. The power of this musk and the ability of skunk to spray it should not be taken lightly. Skunk musk is very strong and can cause vomiting, burning of the eyes or at the very least, smelly clothes.

If releasing unintended or killing intended animals seems challenging to you, do not set traps on land. Focus your efforts on trapping water animals with body-grip traps and submersion sets until you gain the experience needed to properly handle animals trapped on land.

Chapter 13 Fur Handling Equipment, Techniques, and Marketing

Equipment

If you have properly prepared your traps, secured landowner permission, been thorough in your pre-season scouting, and made selective trap sets in the right locations, you'll soon have need for your fur handling equipment. The equipment you will need will depend upon how you plan to sell your catch, whether in the round (whole and un-skinned) or fleshed, stretched, and dried.

Assuming you plan to sell your catch other than in the round (whole and unskinned), you will need some good quality knives and means of keeping them sharp. While nearly any knife will do, there are many good options available for handling furbearers. You may find it useful to have more than one knife while skinning, using one knife for beginning cuts and another for finishing cuts around the head where the blade frequently contacts bone. Two important factors are that the knife has a blade that can take and hold a sharp edge and that it has a comfortable grip that fits your hand well.



There are also several options available for knife-sharpening equipment, from simple whet stones to diamond-impregnated stones, even powered knife sharpeners. Over time, you'll figure out which type will best suit your needs.

You may find it easier to skin the animal while it is hanging. A gambrel is designed for this purpose. The gambrel will have two loops into which the hind feet of the animal are placed. A piece of wood or metal between the loops keeps the legs spread wide enough to make skinning around them easier. Commercial models are available, or the trapper may choose to make one using rope, chain, or cable. A swivel in the line the gambrel hangs from allows the trapper to spin the animal while skinning to get at all sides.

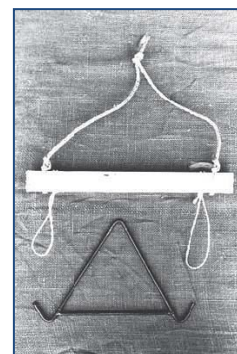

Brushes, combs, and even a fork are useful in removing burrs and dirt from the pelt prior to skinning. Animals with furred tails must have the bone removed (for beaver, muskrat, and

opossum, the tail is simply removed) and the tail split open on some species (refer to Appendix 5 for specifics for each furbearer). Commercial tail stripping tools are available, or the trapper may choose to use a clothespin or a couple of nails. Specially designed tail-slitting knives and guides are also available (the guide ensures a straight cut).

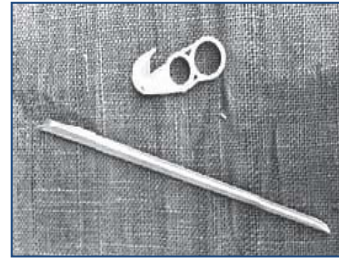

Once the pelt is free from the carcass, it will need to be fleshed to remove excess fat and muscle before being placed on the stretcher. For many species, a fleshing beam will make this process easier while for some species, like muskrat, a small tapered board that can be cradled in the trapper's lap will be sufficient. With either the beam or simple board, the pelt is turned inside out and placed over the device so the fat and meat may be scraped off. The trapper may choose either a single-handled scraper or a double-handled draw knife. For easily fleshed species like muskrat, an old kitchen spoon will work fine.

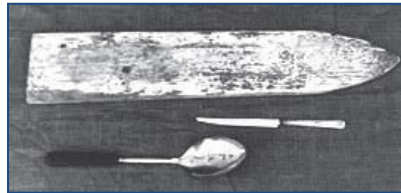

Once the pelt is properly fleshed, it will need to be placed on a stretcher. Both solid wood and metal wire stretchers are available. Some species end up looking better if stretched on one rather than the other, but which type of stretcher to use is really a matter of trapper and fur buyer or fur market preference. A smart trapper will consult the fur buyer for the preferred way to put up different animals before getting started.

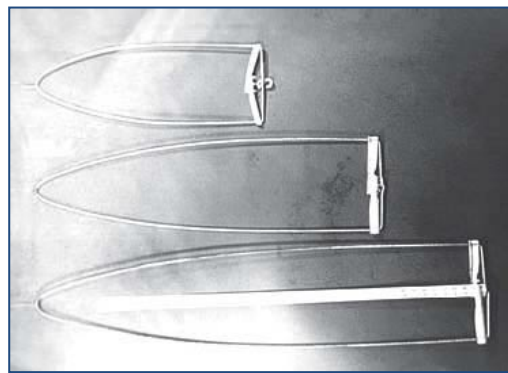

Unlike most furbearers, beaver require special “stretchers.” The trapper can choose from flat plywood boards with various-sized patterns traced onto them or adjustable metal hoop stretchers that can be made larger or smaller to accommodate different-sized beaver. Again, trapper preference will be the determining factor in which type is used. If you have the chance, try both and work with the one that best suits you.



Techniques

Proper fur handling is very important. It can bring much more personal satisfaction from doing a job well, and it can also result in a better price from the fur buyer. Fur handling starts at the trap site. If trapped in the water, the dead furbearer should be rinsed clean of any mud or vegetation. This can usually be accomplished by moving the furbearer head first through the cleanest water available. Attempt to remove as much excess water as possible. Muskrat can be held by the head and shaken or gently whipped to remove much of the water. Furbearers can also be stroked with your hand from the head to the tail to squeeze out water or rolled in the snow to clean and soak up excess water. If they are carried in a vehicle, they can be placed on newspaper or small furbearers such as muskrat can be wrapped in newspapers to help absorb moisture.

If the animal’s fur is still wet later, it should be hung up by the head or forelegs in a cool place to finish drying. Be sure not to hang too long since the pelt may spoil in warm weather. All pelts must be dry before being placed on a drying frame. Directing an oscillating fan onto the animal can aid greatly in the fur drying process.

If the furbearer is not trapped in the water, it should not be rinsed unless the fur is very wet and muddy. If rinsing is necessary, be sure to dry the fur as mentioned above. Keep the fur dry and brush or comb it to remove any burrs or dirt before skinning. A missed burr or clump of dirt can lead to a torn pelt during fleshing.

Watch out for parasites such as fleas, ticks and mites that may be on the animal’s fur (especially land furbearers). It is advisable to wear plastic gloves when skinning.

Furbearers should be skinned as soon as possible after they are killed. The skin is easier to remove when the animal is fresh, and damage to the pelt is less likely. For practice, it is a good idea to carefully skin animals which do not have valuable fur, such as squirrels and woodchucks.

Skimming Cased Fur

There are two recognized ways of skinning animals, and these are called “cased” and “open.” All fur except beaver are prepared cased. Cased furs are removed from the animal by slitting the fur

across from one hind foot pad to the other and pulling it down over the animal's head the way we take off a pullover sweater. Animals with furred tails have the tail split on the underside and left on the pelt. Hairless tails, like those of muskrat, beaver and opossum, are removed at the hair line.

A good example of skinning a cased fur is the raccoon. The first step in skinning a raccoon is to cut the pelt around the ankles and wrists where the long fur ends. Next, the pelt is cut from the heel of each hind foot to the vent and around the vent. Finally, a cut is made from the vent straight down the tail about one-quarter of the way. Start peeling the pelt down the hind legs by pulling the pelt and by cutting connective tissue where necessary. After the pelt is removed from the hind legs, the carcass can be hung at a convenient height by its hind feet. Peel



the pelt off the carcass around the vent. If the raccoon is a male, reproductive organs will be connected to the pelt. These are cut off as close to the pelt as possible. Now peel the pelt from around the base of the tail exposing a couple of inches of the tail bone. Clamp a tail stripper around the tail bone with one hand and hold the base of the tail with your other hand and attempt to pull the tail bone out



of the tail by moving your hands apart. If the tail bone does not pull out, extend the cut from the base of the tail several more inches towards the tip of the tail. Free part of the tail bone from the pelt by cutting the connective tissue and then try to pull the tail bone out as described before. If tail bone still refuses to pull out, extend the cut on the tail to the tip and finish skinning the tail out. Even if the tail pulls out, still extend the cut on the tail straight to the tip. A tail-slitting guide may be helpful. The pelt should now be pulled down the carcass as far as it will go, exposing the forelegs. Further expose the foreleg by cutting the connective tissue.

Wrap fingers from both of your hands around the raccoon's foreleg. With the hand closest to the raccoon's wrist, push the pelt down the foreleg while supporting the foreleg with the other hand. Keep pushing until the raccoon's forefoot passes thru the pelt and the pelt is free. Repeat this process with the other foreleg.



When both forelegs are free, pull the pelt down the carcass past the neck until it won't readily proceed any further. The head of the carcass should now be partly

exposed above the pelt. Start looking for the cartilage on each side of the head that attaches the ears to the skull while continuing to free the pelt by cutting any connective tissues. Once found, the ear cartilage should be cut as close as possible to the skull. Pull the pelt lower and the connective tissue around the eyes should become apparent. This tissue should also be cut close to the skull. (If either the ears or the eyes are difficult to locate, you can clean off your gloves, to

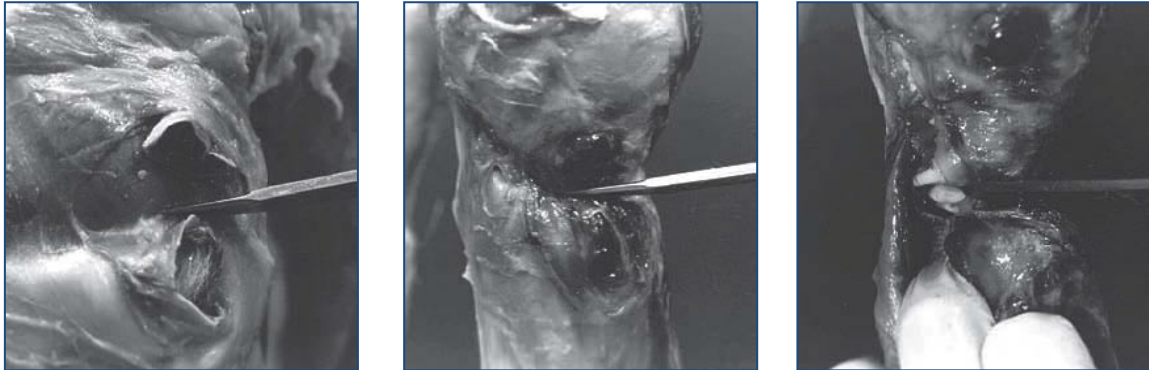

keep the fur clean, and feel the head inside the pelt to determine the correct location for the cut.) If done properly, no fur should be left on the carcass around the ears or eyes. The pelt is pulled down again, finally exposing the loose flesh around the lips. Now free the pelt from the carcass by cutting around the lips and through the nose cartilage near the pelt. The pelt is now ready to be fleshed or rolled fur side out and frozen in a plastic bag.

Fleshing Cased Furs

Fleshing is the act of removing the muscle and fat from the skin. Check with your fur buyer before the season; some buyers prefer to buy un-fleshed pelts to be fleshed by a professional.

Before the pelt is ready to be fleshed, its fur should be dry and free of any mud or burrs. If the pelt is frozen, it should be removed from the plastic bag and thawed completely but slowly (don't leave it next to a stove or heater). Unfrozen pelts with a lot of fat, such as raccoon, skunk or opossum pelts, should be allowed to hang fur side in to cool until the fat stiffens or hardens.

The fleshing job is made easier by using a fleshing beam or fleshing board as described previously. The trapper should try to match the shape of the beam or board with the type of fleshing tool used. One-handed scrapers, hog scrapers and two-handed scrapers with a straight blade work well on the flatter beams and boards. A two-handed scraper with a curved blade works well on a rounder beam or board. Regardless of the equipment used, care should be taken not to apply too much pressure on the pelt. This could cut the hide or the roots of the fur and lower the value of the pelt.

To start fleshing, the pelt is slipped over the fleshing beam or board with the fur side in. If the animal has a tail that is left on the pelt, the tail is usually fleshed first. It is important that all the fat be cleaned from the tail because if any is left on it may spoil or get into the fur.

Many trappers like to flesh a narrow strip around the bottom of the pelt after fleshing the tail. Next, start at the head and flesh a strip down the length of the pelt. The pelt is turned or rotated

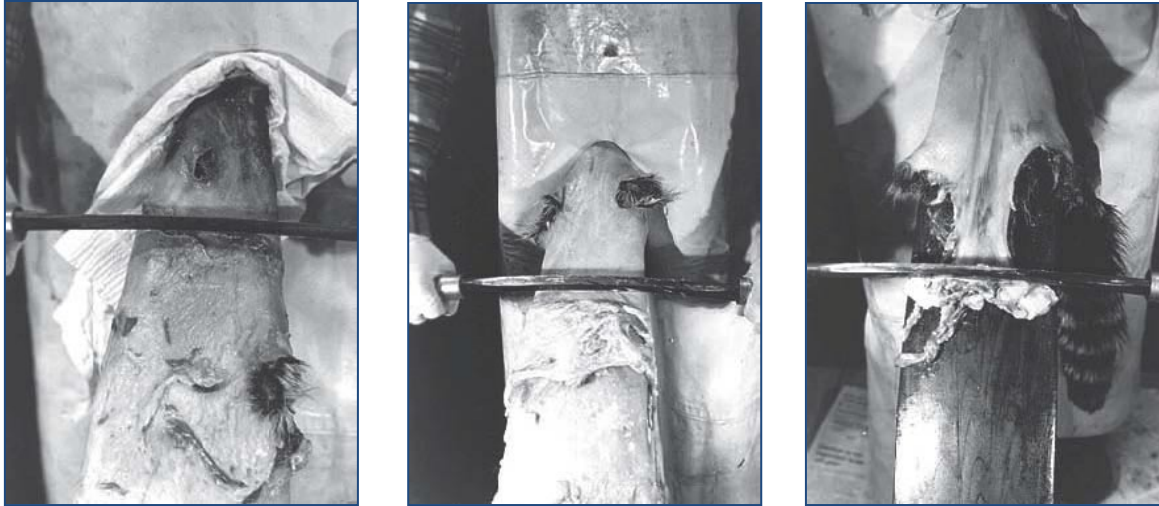

on the beam or board so that the trapper can flesh another strip alongside the first strip. The pelt is turned until all of it has been fleshed. A sharp knife can be used to trim around the lips, eyes and ears. Forelegs should also be checked for fat and fleshed if necessary. A clean dry rag, feed bag, hardwood sawdust, or a paper towel can be used to soak up extra grease or loose fat. Some furbearers, especially red fox and weasel, will only have a small amount of flesh or fat on the pelt and it will only be necessary to scrape where the trapper sees flesh or fat.

Stretching or Boarding Cased Furs

After a pelt is fleshed, it must be held in the proper shape by a drying board or stretcher until the flesh side of the pelt is dry. There are several different types of stretchers. For many species such as muskrat, raccoon, opossum, skunk and fox, wire stretchers are highly preferred by trappers and fur buyers. Wooden stretchers are also used. However, they should have smooth, tapered and nicely curved edges except for their base. Remember to use a belly board or wedge with any non-adjustable wooden stretcher or the pelt may not come off the stretcher without being ripped or cut.

The desired shape and dimensions of stretchers can change over time depending on demands of the fur market.

Wire Stretchers

Cased furs are always arranged on stretchers in such a way that the forelegs and belly will be centered on one side of the stretcher and the eyes, ears and back will be centered on the other side. Place the pelt fur side in on the stretcher, centered as described, and pull the pelt down the stretcher until snug. Wire stretchers usually have two or more arms that move up and down the stretcher. These arms are



attached (pronged) into the edge of the hide in the center of the stretcher. Muskrat pelts are attached at the tail and belly portions of the pelt, each on a separate arm. All other cased pelts have the tail portion of the pelt attached to one arm and the two hind feet attached to the other arm. The arms are pulled towards the bottom of the stretcher until snug. The pelt is then wiped clean again and is ready to dry.

Wooden Stretchers

Place the pelt on the board fur side in. Starting below the front legs, push the belly of the pelt slightly toward the head with your thumbs and at the same time pull the back of it slightly down towards the tail with your fingers. Keep doing this all the way down to the bottom of the pelt. This will make the belly shorter and lengthen the back making a better inspection-area window yet not thinning the fur

Now, turn the board over with the back of the pelt facing up. With the board sitting this way, start at the root of the tail to stretch the tail wide and, at the same time, push it towards the rump to shorten the tail. Do this all the way to the tip of the tail, then work back again. This makes a better-looking job of the inspection-area window and thickens the fur instead of thinning it, which happens when the tail is stretched out lengthwise.

Now with the pelt placed smoothly and evenly on the board with the tail well cleaned and opened, it can be fastened to the board with a few tacks or push pins around the skirt and a few along the edge of the tail. Cut off the lower lip. Let the skin of the front legs stick out free from the pelt. Do not fold the front legs together nor turn them back inside the pelt as either way can cause rot and the hair to slip. The back legs of the pelt can be fastened with one or two tacks.

A belly board should be used with the one-piece drying board. The belly board is 5/16" by 5/16" by 30" and sloped or tapered from one end to the other so it can be removed after the pelt is dry. Place the smallest end between the drying board and the pelt on the belly side and push it ahead until the belly board goes up to the head of the pelt.

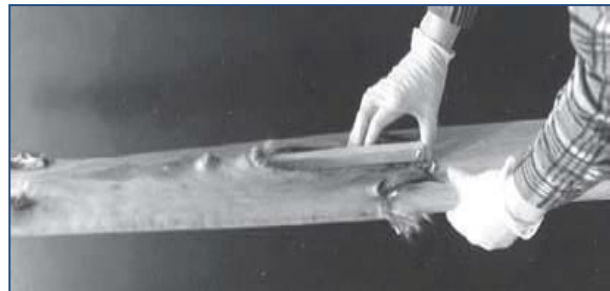

Again wipe the pelt clean. The pelt is now ready for drying.

Drying Cased Furs

After the pelt has been boarded, it should be hung to dry in a place away from the stove, sunlight or strong hot winds. If it is dried too fast, the leather will be ruined. A temperature of 55 to 60 degrees F (13 to 15 degrees C) is about right. Protect drying pelts from pests such as mice.

The pelts will dry in 24 to 60 hours, depending on the amount of air movement passing through the drying place. They should be wiped with a dry, clean rag occasionally to take off sweat and

any fat that might work out of the leather. When the pelts have been on the drying board long enough to dry, they should be taken off and hung by the nose until the head and legs are fully dry before selling. Cased pelts should not be folded, but should be packed flat, one on top of the other. Folding makes a crease and takes away some of the good appearance.

Pelts of foxes, coyotes, fisher, marten and bobcat should be turned fur-side out before final drying. This is best done after the pelts have been on the stretchers for 24 hours or less and the leather is dry to the touch but still pliable. Check on the drying pelt repeatedly well in advance of the 24 hours to ensure the pelt does not become too dry prior to turning. If you wait too long, turning the pelt will be difficult and could result in damaged or torn leather. If this happens, moisten the leather with damp rags until it becomes pliable again. Be careful to not over-moisten the leather as this could encourage the growth of mold on the leather and reduce the overall value of the pelt.

Appendix 5 contains specifics for how the fur of each species is prepared, including appropriate stretcher sizes.

Skinning Open Fur (Beaver)



The beaver is the only furbearer in New York that is skinned open. The fur handling process up to skinning is the same as for other furbearers, that is, the animal should be clean and dry. Lay the beaver on its back and stroke the fur from its chin to its tail. Then, use an index finger to mark a straight line from the base of the beaver's tail

to its chin. Be sure the line is straight. Cut along the line from tail

to chin being careful to cut only through the skin, particularly around the vent and in the vicinity of the castors. Then cut off the feet at the fur

line. The tail can be removed in a similar fashion; but most trappers simply cut the skin around the base of the tail, since it makes an excellent handle.



Start pulling and cutting the skin free from the carcass along the midline cut. Take care not to cut the castors located on either side of the midline just above the vent (these may be removed and dried for sale or used in making lures). When the fat layer gives way to a layer of flesh, cut deeper, leaving the flesh on the pelt. Take care around the legs so that the skin is not cut, and continue to cut and pull the pelt free. When the skin is loose from the underside of the animal,

flip it over and complete the skinning job. Take care around the lips, nose, eyes, and ears. On beaver, the ears are connected to the skull by a cartilage and a boney canal. Carefully cut at the base of the cartilage. Then skin out the rest of the upper jaw and nose. After the pelt is free, it is ready to be fleshed and dried or frozen. To freeze a beaver pelt, fold the pelt in half (leather side to leather side), roll the pelt up, place in a heavy plastic bag and freeze.

Fleshing Beaver Pelts

As mentioned earlier, the fur of beaver pelts should be dry and free of mud and burrs and the fat should be cooled until it stiffens or hardens. Since beaver pelts are skinned open, they can't be placed on a fleshing beam or board like other pelts. However, a leg hole can be slipped over the tip of the fleshing beam or board. Then the area around each leg hole can be fleshed strip by strip as mentioned in fleshing cased furs. Next, place the pelt on a beaver stretching board by first fastening the nose with a nail (close to the edge of the pelt), then draw the tail tight and fasten it with another nail. The pelt is stretched as wide as it will go and fastened with two more nails. Finally, draw the pelt tight and fasten with four more nails, each halfway between the first four.

Using a two-bladed fleshing knife (one blade is dull, the other sharp), flesh a strip around the sides of the beaver. The remaining muscle, grizzle and fat can be fleshed either from the tail, head and sides to the center of the pelt, or if the muscle, grizzle and fat can be separated from the center of the pelt, it can be fleshed in strips from the center. On some sections of the pelt, fat will be easily fleshed; however, in many areas fat and flesh may have to be cut free from the pelt with a sharp knife (especially around the tail and head). As mentioned earlier, a clean dry rag, feedbag or a paper towel can be used as needed to soak up extra grease or loose fat.

Boarding Beaver Pelts

Beaver pelts are dried in an oval shape on a large sheet of heavy plywood or a board made from smooth lumber. Commercially available, adjustable metal wire hoops may also be used.

It is usually better to try to estimate the best length and width of the beaver pelt before nailing it to the board. In order to do this, hang the pelt by the nose and measure its length (don't pull on the pelt when measuring). Take this initial measurement and divide by ten. This smaller number plus one inch is then subtracted from the initial measurement to determine the length of the pelt, and the smaller number is again subtracted from the length to determine the width of the pelt. For example, if the pelt measures 30" from the tip of its nose to the tip of its tail when it is hanging, then 30 divided by 10 is 3. Therefore, the pelt's length would be 26" [30-(3+1)] and the width would be 23" (26-3).

To correctly dry the beaver pelt, first remove the nose and lips from the pelt. Center it on the drying board. Then fasten the head end of the pelt by driving a nail through the pelt (about 1/8 inch from its edge) into the board. Next, fasten the edge of the tail portion of the pelt the length distance from the nose. The middle of both sides is then fastened the width distance apart. The

pelt should still be a little loose and not stretched tight. Draw the pelt out and fasten with four more nails, each halfway between two of the first four nails. These first eight nails should now form the outline for the pelt's round or oval shape.

Continue fastening the pelt onto the board by nailing one side midway between two existing nails, then going to the opposite side of the pelt for the next nail. Maintain this pattern until there is no space between nails greater than four inches. Then fill in these spaces with nails about an inch apart. Leave the nails sticking up at least one inch. The leg holes of the beaver should not be left hanging open. They give the pelt a rough look and could cause a loss in value. Pull the sides of each leg hole together and close them with two to four nails.

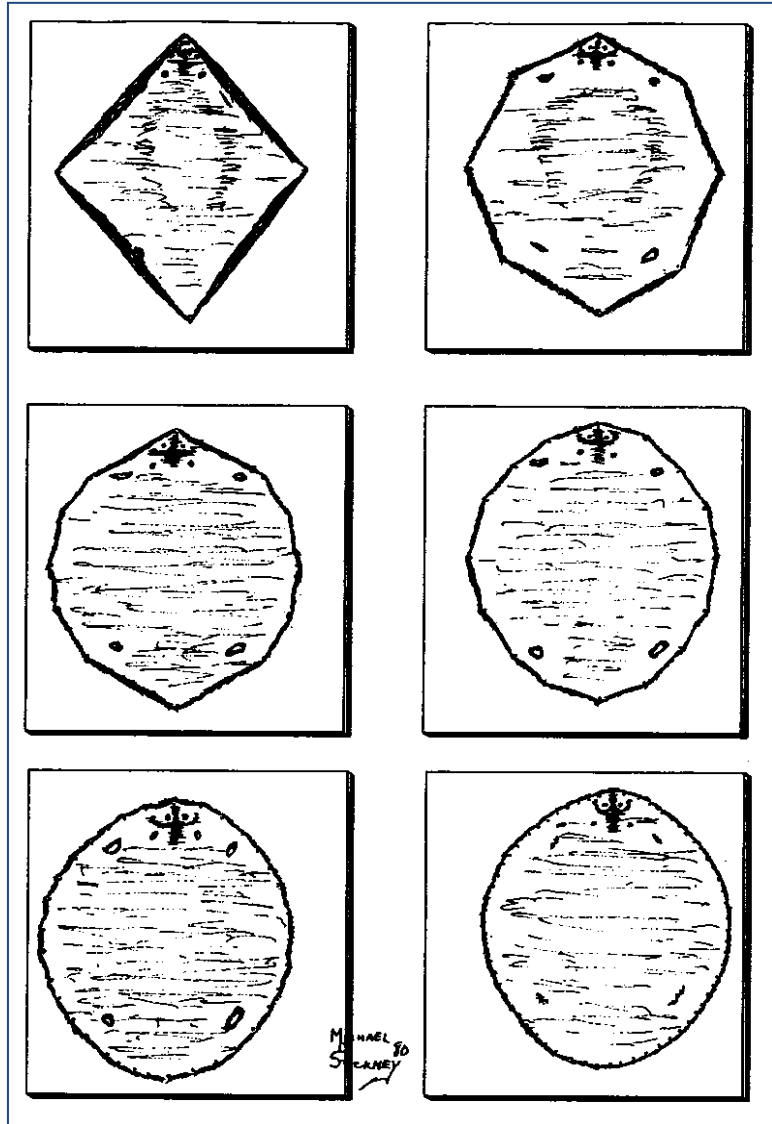

Now the nailing is completed and should look like the illustration. The pelt should be wiped or washed clean of any bits of fat, grease or blood still on the leather. The pelt can be raised on the nails to let air underneath for more complete drying.

Drying Beaver Pelts

As with all other types of pelts, beaver should be dried slowly in a cool place away from the stove, hot sunlight or hot, strong winds. As it dries, it should be wiped from time to time with a clean, dry rag, to take off any fat coming out of the leather. When the pelt is thoroughly dry, carefully pull out the nails and take the pelt off the board. Brush out the fur until it is clean and shiny. Some trappers leave pelts on boards until just before selling since they have a tendency to shrink after being taken off the board.

Storing Pelts

After the pelt is completely dried, it can be removed from the stretcher and stored. Most trappers try to hang their pelts in a dry place away from excessive heat and where they cannot be damaged by animals. Be sure to wipe off any grease that might sweat out of a hide and don't let grease get on the fur of any hide. Store fur to fur or leather to leather. They may be rolled up end to end for shipping, but, if at all possible, it is best to keep them flat.

Marketing

The trapper has several options for how to sell furs. If you are lacking in fur handling skill or don't have the space or time to do it properly, animals can be sold un-skinned or in the round. Check with your local fur buyer before using this approach to ensure that he or she will purchase animals in this condition. Selling in the round generally means you will be paid less money for your furs as they will require considerable work on the part of the fur buyer to process for further sale.

Selling the hides "green" is another option. With this approach, the trapper skins the animals that are caught but does not flesh or stretch them. The green furs are sold as they are caught or rolled up fur side out, placed in plastic bags and frozen. When the trapper is ready to sell, the furs are removed from the freezer and thawed prior to being brought to the buyer or auction. Again, lower prices will be paid for green fur as they will need to be fleshed and stretched before they are sold again.

Most trappers prefer to sell their furs fleshed and stretched, taking as much pride in their ability to properly prepare a pelt as they do in catching the animal it came from. This method offers the trapper the most flexibility in selling the pelt as properly dried furs can be stored for longer periods of time. This allows the trapper to sell the pelts at the time of his or her choosing. Properly handled pelts are the final step to becoming a responsible and successful trapper.

Furs can be sold to local or "country" fur buyers, at local auctions organized by various trapper organizations or at larger auctions with buyers from around the world.

Country buyers are still found in many areas of the state. An advantage of country buyers is that the trapper gets to deal with the buyer personally.

Local auctions are another good option. Generally held in the late fall and early spring, these sales tend to attract a number of fur buyers. An advantage of this approach is that buyers compete with one another, often increasing the price the trapper can receive for his furs. Another advantage is the option to "no sale" the furs if the trapper is not happy with the offered price. Most local auctions charge a small commission on the sale of the pelts.

Finally, larger international auction houses are another option. These outfits typically employ agents who travel routes around the state with several stops where they pick up furs from

trappers. Though these auction houses generally charge a higher commission, this is often offset by higher prices being paid for the furs due to the intense competition between buyers from several different countries. Information about these options is often available in magazines that cater to the fur harvesting community.

Appendix 1 Traps, Sets, & Attractors

| Furbearer | Traps | Sets | Bait & Lure |
|-------------|---|---|--|
| Coyote | Review BMP materials for preferred trap types and sizes | Dirt-hole, flat, post, cable restraints | Bait: Covered meat or fish Lure: Fox or coyote lure, urine |
| Red Fox | Review BMP materials for preferred trap types and sizes | Dirt-hole, flat, post, cable restraints | Bait: Covered meat or fish Lure: Fox lure, urine |
| Gray Fox | Review BMP materials for preferred trap types and sizes | Dirt-hole, flat, post, cable restraints | Bait: Covered meat, eggs, fish Lure: Fox lure, urine |
| Beaver | Review BMP materials for preferred trap types and sizes | Climb out, scent mound, Channel, open water beaver Set, under-ice | Bait: Small sticks of poplar, willow, cottonwood Lure: Commercial or home-made castor scents |
| Muskrat | Review BMP materials for preferred trap types and sizes | Feedbed, trail, pocket, runway Floating | Bait: Apples, carrots, ear corn, turnip, orange peels Lure: Musk glands from male muskrats |
| Bobcat | Review BMP materials for preferred trap types and sizes | Dirt-hole or cubby | Bait: Fish, beaver or rabbit meat Lure: Anise, catnip, fish, oil beaver castor, other glands |
| Mink | Review BMP materials for preferred trap types and sizes | Pocket, trail, cubby, channel, obstruction | Bait: Chunks of fish or fresh Muskrat Lure: Mink/muskrat musk, Scat, urine, fish oil |
| River Otter | Review BMP materials for preferred trap types and sizes | Otter latrine or channel sets | Bait: Fresh fish or muskrat Lure: None recommended |
| Fisher | Review BMP materials for preferred trap types and sizes | Dirt-hole, cubby, leaning pole | Bait: Raccoon or porcupine meat, fish Lure: Fisher musk & urine, beaver castor, skunk essence |
| Marten | Review BMP materials for preferred trap types and sizes | Cubby, running pole | Bait: Chunks of meat or fish, strawberry jam Lure: Skunk essence |
| Weasels | Review BMP materials for preferred trap types and sizes | Cubby, traps in boxes or hollow logs | Bait: Bloody meat or rabbit Lure: Weasel gland scent |

| Furbearer | Traps | Sets | Bait & Lure |
|---------------|---|--|--|
| Striped Skunk | Review BMP materials for preferred trap types and sizes | Dirt-hole, cubby | Bait: Fresh or tainted meat, fish, or eggs Lure: Fish oil, skunk musk, Anise, honey |
| Opossum | Review BMP materials for preferred trap types and sizes | Dirt-hole, cubby | Bait: jelly, jam fruit, meat, eggs, cheese, fish Lure: Not necessary |
| Raccoon | Review BMP materials for preferred trap types and sizes | Pocket, cubby, spring run, cage, dirt-hole | Bait: Chunks of fish or muskrat Lure: Fish oil, anise, honey, hard candy |

Appendix 2 Tracks of New York Furbearers

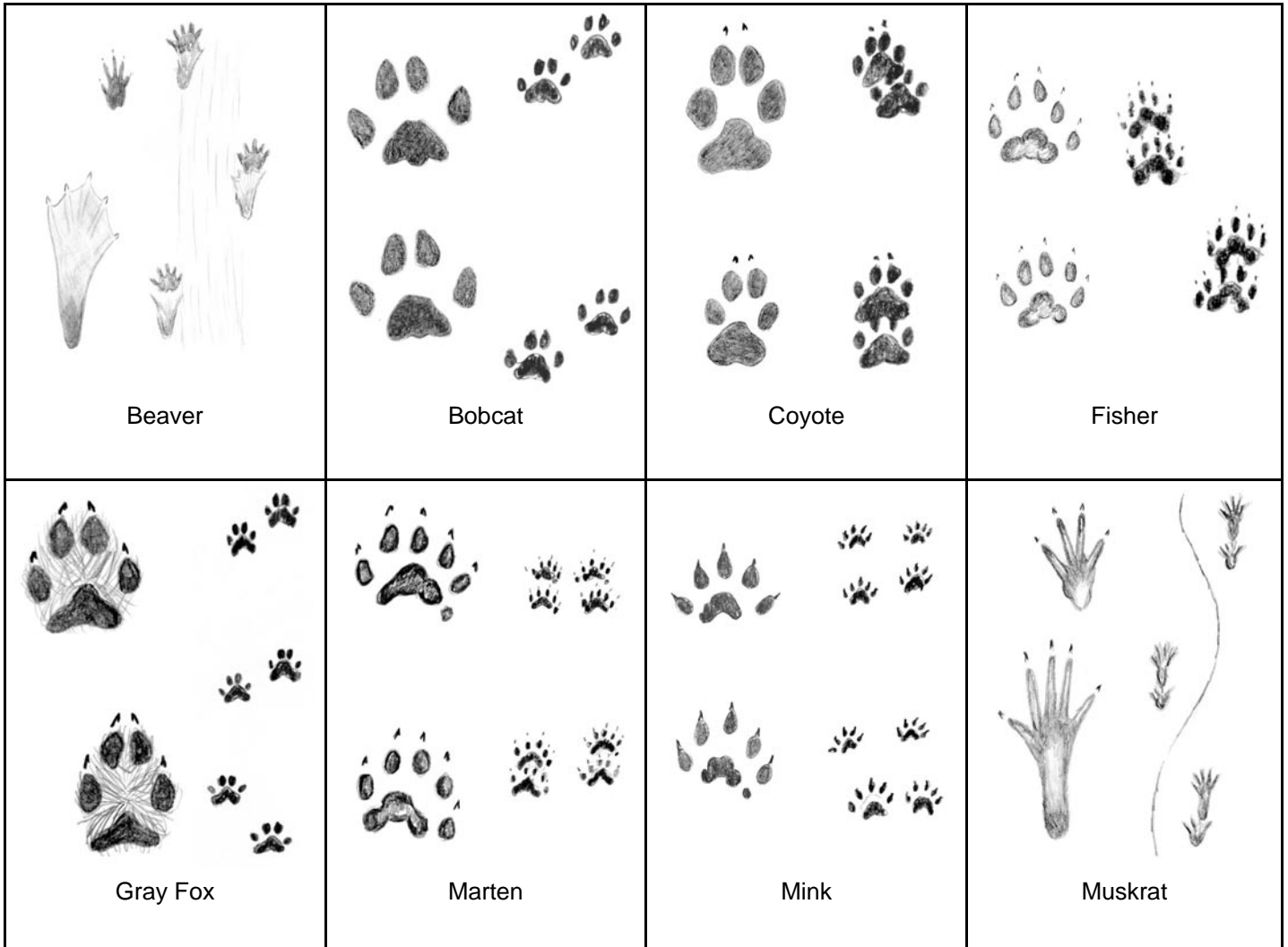

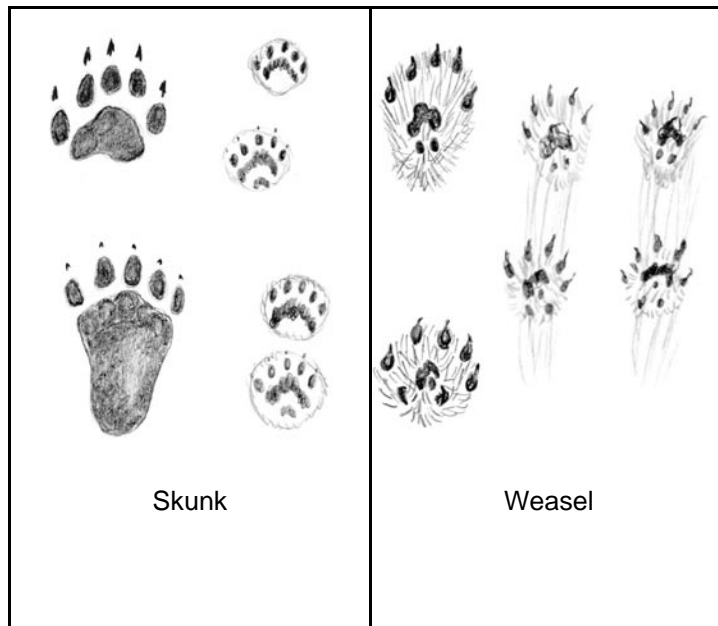
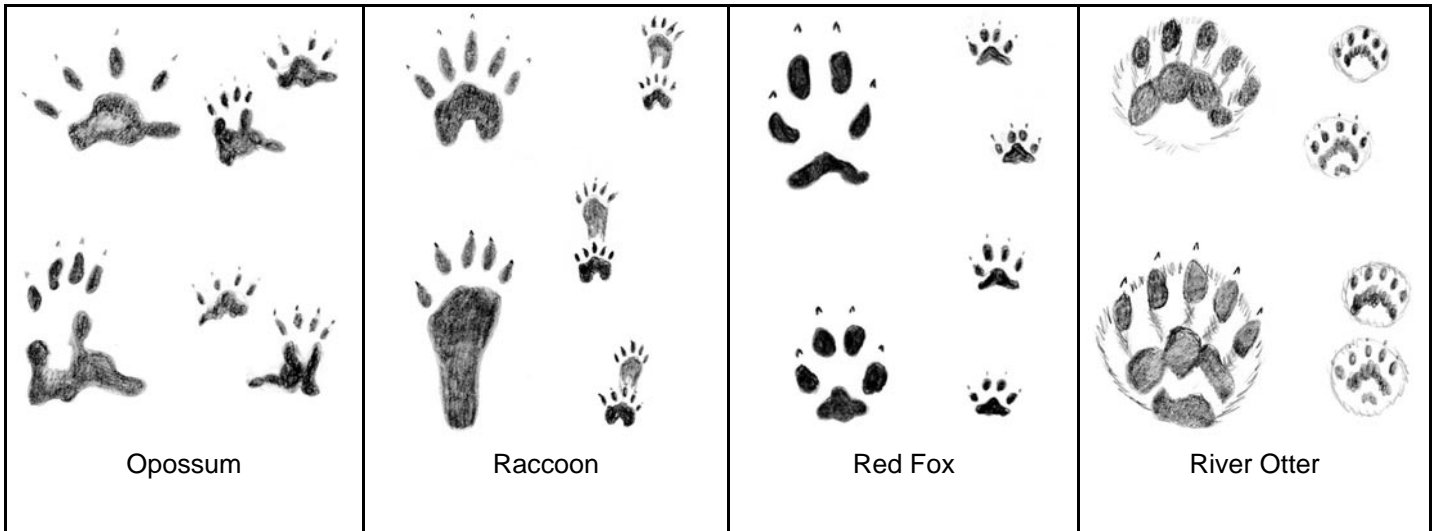

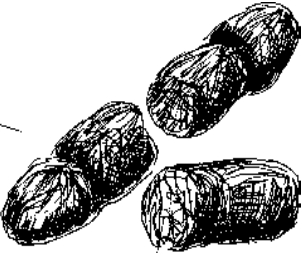









Image Credits - Mary
Wentz, Silvertip Productions

Appendix 3 Scats of New York Furbearers

| | | |
|--|---|--|
|  <p>Beaver</p> |  <p>Bobcat</p> |  <p>Coyote</p> |
|  <p>Fisher</p> |  <p>Gray Fox</p> |  <p>Marten</p> |
|  <p>Mink</p> |  <p>Muskrat</p> |  <p>Opossum</p> |



Red Fox



Skunk



Raccoon



River Otter



Weasel

Appendix 4 Regulations for Body-Grip Traps Set on Land

Body-gripping traps set on land shall not be within 100 feet of a public trail except on Wildlife Management Areas.

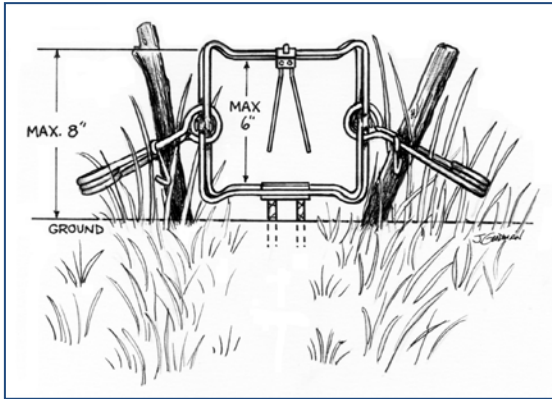

A body-gripping trap measuring less than 5 ½ inches may be set in any manner **with or without the use of bait**. Body-gripping traps measuring 5 ½ inches to 6 inches, set without the use of bait, must be set so that no part of the trap is 8 inches or more above the ground.

Body-gripping traps 5 ½ inches to 7 ½ inches set **with the use of bait, lure, or other attractants** may only be used as follows:

Four or more feet off the ground

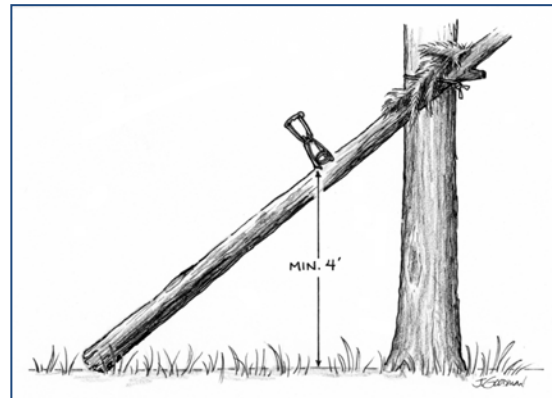

In a container of the following design:

- trap recessed minimum of 18 inches
- opening height and width of 10 inches or less

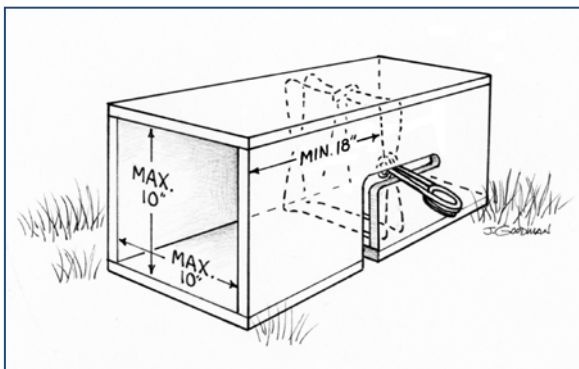

In a container of the following design:

- opening height 6 inches or less
- 8 inch minimum spring notches
- trap recessed minimum of 4 inches

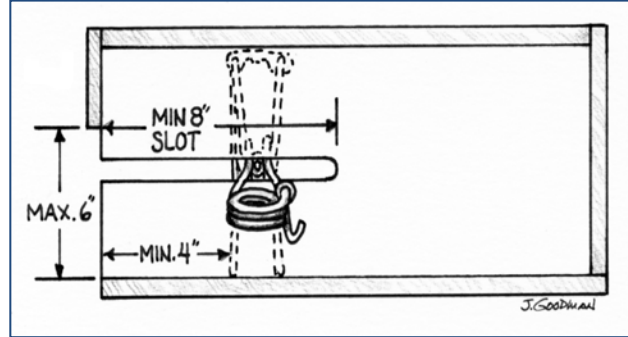
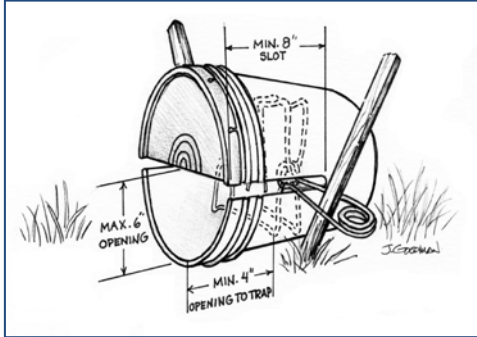

You may also build an enclosure of natural materials (e.g. logs or rocks)

- opening height 6 inches or less
- trap recessed minimum of 8 inches

In a container of the following design:

- only one entrance, facing the ground
- container set so entrance is no more than 6 inches from ground
- trap recessed minimum of 4 inches

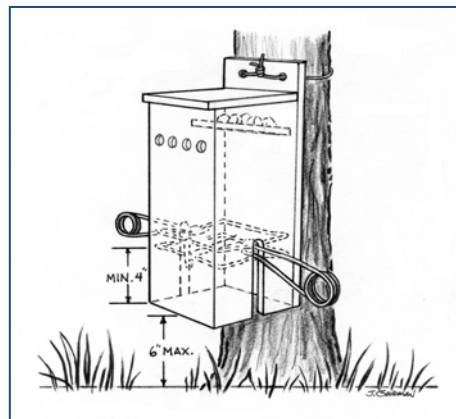

Trappers are reminded to review their "Hunting & Trapping Regulations Guide" annually for potential changes to these and other regulations and season dates.

Appendix 5 Pelt Preparation

| Furbearer | Pelt Preparation | Stretcher Size - Inches | | | | |
|-------------|---|-------------------------|--------|------|----------|------|
| | | Size | Length | Base | Shoulder | Neck |
| Coyote | Skin cased, split tail. Remove fat and flesh. Pelt immediately. Turn pelt fur side out when skin is dry to the touch | Large | 75 | 13 | 9.5 | 14 |
| | | Average | 70 | 12 | 9 | 13 |
| | | Small | 65 | 11 | 8 | 12 |
| Red Fox | Skin cased, split tail. Remove fat and flesh. Pelt immediately. Turn pelt fur side out when skin is dry to the touch | Large | 56 | 8 | 6 | 11.5 |
| | | Average | 54 | 7 | 5 | 11 |
| | | Small | 50 | 6.5 | 4.5 | 10 |
| Gray Fox | Skin cased, split tail, Gray fox have more to flesh than red fox which should be removed. Pelt immediately. Turn pelt fur side out when skin is dry to the touch | Large | 56 | 9 | 6 | 11.5 |
| | | Average | 54 | 7 | 5 | 11 |
| | | Small | 50 | 6.5 | 4.5 | 10 |
| Beaver | Skinned open, flesh well, dried in oval shape by nailing on pattern board, or sewn to hoop. If nailed, lift pelt on nails a short time after boarding. This allows air to circulate between pelt and board. | | | | | |
| Muskrat | Skin cased with tail removed, don't overflesh, market fur in | Large | 22 | 20 | 6.5 | 6 |
| | | Average | 21 | 7.5 | 6 | 5.5 |
| | | Small | 20 | 7 | 5.5 | 5 |
| Bobcat | Skin cased, remove claws, remove all flesh and fat, market fur out | Large | 70 | 10 | 7 | 12 |
| | | Average | 60 | 9 | 6.5 | 11 |
| | | Small | 48 | 7 | 5 | 10 |
| Mink | Skin cased, split tail, remove all fat but leave saddle, market fur side in | Large male | 40 | 5 | 3.25 | 8.5 |
| | | Large female | 36 | 4 | 3 | 8 |
| River Otter | Skin cased, flesh well, cut front legs short and sew closed, pin tail in V shape, market fur in | Large | 65 | 8 | 6.75 | 15 |
| | | Average | 58 | 7.5 | 6 | 13.5 |
| | | Small | 32 | 7 | 5 | 9 |
| Fisher | Skin cased, flesh well, market fur out | Large male | 50 | 8 | 6 | 10 |
| | | Large female | 48 | 7 | 5 | 9.5 |
| Marten | Cased, split tail, market fur side out, little or no fleshing needed | Large male | 40 | 5 | 3.25 | 8.5 |
| | | Large female | 36 | 4.5 | 3 | 7 |
| Weasels | Skin cased, market fur in, remove tail bone but do not split the tail | Large | 22 | 3 | 2.5 | 5.5 |
| | | Average | 16 | 2.5 | 1.75 | 4 |
| | | Small | 12 | 1.75 | 1.25 | 3 |

| Furbearer | Pelt Preparation | Stretcher Size - Inches | | | | |
|-----------|---|-------------------------|--------|------|----------|------|
| | | Size | Length | Base | Shoulder | Neck |
| Opossum | Skin cased, tail off, fur side in; flesh carefully to avoid tears | Large | 38 | 8 | 6 | 10.5 |
| | | Average | 36 | 7.5 | 5.5 | 10 |
| | | Small | 32 | 7 | 5 | 9 |
| Raccoon | Skin cased, tail split scraped. Remove all flesh & fat. Market fur in | Large | 48 | 10 | 7.5 | 12.5 |
| | | Average | 42 | 9 | 6.5 | 12 |
| | | Small | 34 | 8 | 5.5 | 11.5 |