

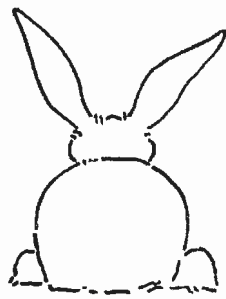

*VITA Technical Publication*

**RAISING RABBITS**

By  
Harlan H.D. Attfield



# RAISING RABBITS

*and caries for meat*

by

Harlan HD Attfield



a **Vita** publication

**Raising Rabbits and Cavies for Meat**

ISBN: 0-86619-330-8

© 2001, Harlan H. D. Attfield and Volunteers in Technical Assistance

# Table of Contents

		<b>Page</b>
<b>Chapter 1</b>	<b>Introduction</b>	6
<b>Chapter 2</b>	<b>Preparing to Raise Rabbits</b>	8
	Choosing the Breed of Rabbit	9
	The Hutch	10
	Preparations for Feeding	17
<b>Chapter 3</b>	<b>Caring for Rabbits</b>	22
	Check New Stock Carefully	22
	Handling Rabbits	23
	Feeding Rabbits	24
<b>Chapter 4</b>	<b>Breeding Rabbits</b>	33
	How to Mate Rabbits	34
	Feeling for Young Rabbits	36
	Kindling	36
	Weaning	39
	Determining Sex	40
	Orphan Litters	41
	Balancing Litter Size	41
	Failures to Conceive	42
<b>Chapter 5</b>	<b>Keeping Records</b>	43
<b>Chapter 6</b>	<b>Common Rabbit Diseases and Their Control</b>	46
	Abscesses	47
	Buck Teeth	48
	Caked Breast (Caked Udder)	49
	Coccidiosis, Liver and Intestinal	50
	Colds or Snuffles	51
	Ear Mange or Ear Canker	52
	Enteritis, Nonspecific and Muroid	54
	Hutch Burn	55
	Mastitis	56
	Myxomatosis	57
	Pneumonia	58

	Ringworm	59
	Skin Mange and Lice	59
	Sore Hocks	60
	Vent Disease or Rabbit Syphilis	62
	Wet Dewlap	62
	Wry Neck	63
<b>Chapter 7</b>	<b>Killing, Skinning and Tanning</b>	64
	Killing and Skinning a Rabbit	65
	Tanning a Rabbit Skin	68
<b>Chapter 8</b>	<b>Hutch Construction</b>	71
	Wood Hutch with Metal Roof	71
	Wood and Bamboo Hutch	83
<b>Chapter 9</b>	<b>Commercial Feeds and Feeding in the USA</b>	85
<b>Chapter 10</b>	<b>Preparing for Exhibits and Shows</b>	91
<b>Chapter 11</b>	<b>Worm Husbandry</b>	104
<b>Chapter 12</b>	<b>Raising Guinea Pigs (Cavies)</b>	106
	Selecting	108
	Handling	108
	Feeding	109
	Housing	110
	Mating	113
	Ailments	114
	Killing and Skinning a Cavy	115

This field guide is dedicated  
to all the Illustrators, past and present,  
the *authors* of my books.

## Preface

This field guide presents an overview of the entire process of raising rabbits — from selecting healthy animals to preparing proper foods and treating disease. Chapter 8 includes step-by-step procedures for the construction of a hutch unit to house two does and one buck. *Raising Rabbits and Cavies for Meat* is written in clear, straightforward language. It reflects the author's emphasis on preparing material that can be used easily by extension workers and by do-it-yourselfers, regardless of cultural context or geographic location.

Harlan H. D. Attfield, the author, is an Agro-Ecologist who specializes in small-scale, integrated farming programs, small-stock, beekeeping, and tropical vegetable gardening. He has been designing tropical agricultural projects since 1966 and has served in Nigeria, Ethiopia, Mauritius, Bangladesh, Haiti, and the Congo. Mr. Attfield has published numerous articles and books for Volunteers In Technical Assistance (VITA) detailing his experiences. He places special emphasis on effective communication with extension workers.

Illustrations are by Catharine S. Roache, an author and illustrator of children's books, as well as a poet; Dr. Lisa Bird, an expert in the field of special education and a longtime friend of the author; Heathere Booth Cericola, a painter and illustrator of life forms for books; the cover and illustrations of cavies are by Jennifer Poon, an accomplished artist residing in the San Francisco Bay Area; the hutch illustrations are by George R. Clark an instructor in drafting and design at Kellogg Community College. Clark has contributed technical drawings and expertise to a number of VITA publications and projects.

The author owes a special note of thanks to the authors of the *Rabbit Handbook*, published by the University of California, Division of Agriculture and Natural Resources, for sharing information

on rabbit breeds, feeds, disease control, and preparing for exhibits and shows.

The author also wishes to thank Dr. J. I. McNitt (Center for Small Farm Research, Southern University, Baton Rouge, Louisiana, USA), and Dr. S.D. Lukefahr (Department of Animal and Wildlife Sciences, Texas A&M University, Kingsville, Texas USA), noted authorities on rabbits and small livestock, who reviewed this book and provided valuable suggestions and technical information.

Barbra Bucci, former executive editor for VITA, was responsible for typesetting and layout of this book. Final production was done by Urban Cabin in Oakland, California USA.

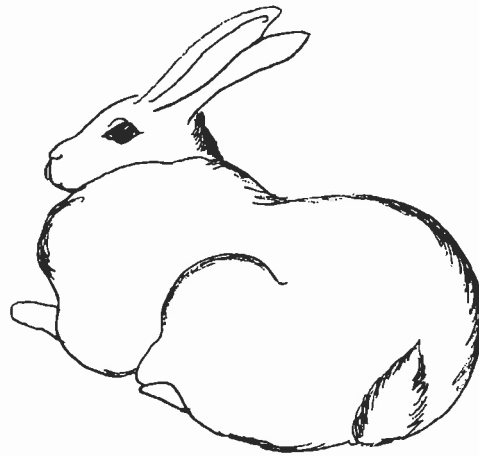



# Contents

Chapter 1	Introduction
Chapter 2	Preparing To Raise Rabbits
	Choosing the Breed of Rabbit
	The Hutch
	Preparations for Feeding
Chapter 3	Caring For Rabbits
	Check New Stock Carefully
	Handling Rabbits
	Feeding Rabbits
Chapter 4	Breeding Rabbits
	How to Mate Rabbits
	Feeling for Young Rabbits
	Kindling
	Weaning
	Determining Sex
	Orphan Litters
	Balancing Litter Size
	Failures to Conceive
Chapter 5	Keeping Records

## Chapter 6

### Rabbit Diseases And Their Control

Abscesses  
Buck Teeth  
Caked Breast (Caked Udder)  
Coccidiosis, Liver and Intestinal  
Colds or Snuffles  
Ear Mange or Ear Canker  
Enteritis, Nonspecific and Muroid  
Hutch Burn  
Mastitis  
Myxomatosis  
Pneumonia  
Ringworm  
Skin Mange and Lice  
Sore Hocks  
Vent Disease or Rabbit Syphilis  
Wet Dewlap  
Wry Neck

## Chapter 7

### Killing, Skinning, and Tanning

Killing and Skinning a Rabbit  
Tanning a Rabbit Skin

## Chapter 8

### Hutch Construction

Wood Hutch with Metal Roof  
Wood and Bamboo Hutch

Chapter 9	Commercial Feeds and Feeding In The USA
Chapter 10	Preparing For Exhibits And Shows
Chapter 11	Worm Husbandry
Chapter 12	Raising Guinea Pigs (Cavies)
	Selecting
	Handling
	Feeding
	Housing
	Mating
	Ailments
	Killing and Skinning a Cavy



This field guide is dedicated  
to all the Illustrators, past and present,  
the *authors* of my books.

## Introduction

There are a number of reasons why raising rabbits is becoming a more and more important activity throughout the world:



Rabbits can produce large amounts of delicious meat. Although rabbit meat is firmer, it tastes very much like chicken. Rabbit meat contains a lot of protein and is low in calories, fat, sodium (salt), and cholesterol. So rabbit meat is both a tasty and a healthy food.



Rabbits multiply quickly. With excellent feed and care, a rabbit raiser can start with 2 females and 1 male and produce 50 or more rabbits in one year. Even when only local forage and feed is available 3–4 females and 1 male can furnish 2 kg of meat per week to strengthen the family diet. On the other hand, 50–150 females can mean a business which provides part-time employment and perhaps extra income.



Rabbits are easy to raise at home—whether home is in the city or the country. Rabbit hutches do not take up a lot of space, and rabbits are clean, quiet, and easy to care for.



Rabbit skins are also valuable; they can be made into hats, collars, slippers, pillows, small rugs, etc.

In addition, gardeners and farmers often use rabbit manure as a fertilizer. The manure of well-fed rabbits contains nitrogen and phosphorus. This manure can be mixed directly into the soil to help the growth of crops. This is especially important to the farmers and gardeners who cannot afford or find other fertilizers,

and to those who wish to make the best possible use of all the natural resources of their farms.

There are only a few simple rules to follow in order to raise rabbits successfully:

 Build a good hutch.

 Begin with healthy animals.

 Give rabbits good care.

This publication does not address itself to commercial projects (hundreds and thousands of rabbits). Operations of this type require a highly efficient level of production and access to commercial feed and equipment to provide a reasonable income.

For those interested in starting community projects, I highly recommend Dr. S.D. Lukefahr's book, *The Rabbit Project Manual*, published by Heifer Project International, Little Rock, Arkansas 72203, USA. This book is an excellent trainer's manual for meat project development. It provides concise information on project feasibility, design, implementation, monitoring, and evaluation.

Why not try raising rabbits.



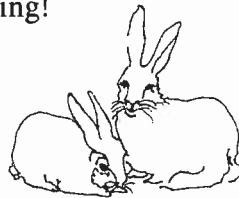

Good luck and good farming!

Harlan HD Attfield



## Preparing To Raise Rabbits

Most people who decide to raise rabbits want to produce meat. And they want to produce this meat as quickly and cheaply as possible. Therefore, before beginning any part of the project, it is very important to decide:

-  how much room there is for raising rabbits. If there is only room for a few hutches, there is a limit on the number of rabbits which can be raised.
-  how much time is available for the project. Because rabbits are easy to manage, women and children can contribute to the collection of forages, daily cleaning, and feeding of the rabbits. It is estimated that each breeding female will require about 10–18 hours of labor a year, 30–40 minutes to produce one kilogram of rabbit meat.
-  what kinds or breeds of rabbit are available. Some breeds of rabbits grow more quickly; some are better for eating. In other words, it is necessary to check the sources of rabbits to see if a good breed is available. The size of the breed will determine the size of the hutch.
-  what foods are available for feeding the rabbits. Rabbits will eat a variety of foods, but some are more important for rabbits than others. Some will lead to faster growth; some are more expensive; etc.

It is always best to begin any project by studying and understanding all parts of it. Therefore, it is a good idea for a prospective rabbit raiser to read through all the information in this handbook before taking any steps. Successful rabbit raising depends upon setting up the effort so that few problems are likely to occur, and

upon managing the project so that any problems which do come up can be handled quickly and easily.

## Choosing The Breed Of Rabbit

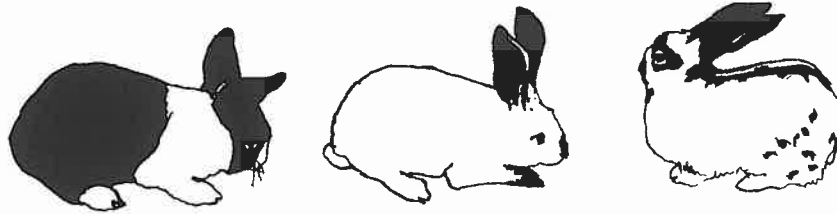

There are over sixty breeds and varieties of rabbits in the world (see Chapter 10). Some breeds might be better suited than others when considering local climatic conditions and the consumer's preferences. In general, breeds, or different kinds of rabbits, can be put into three main groups, according to size:

 *Small Breeds* — The Polish rabbit, for example, weighs a little more than 2 1/4 lbs (0.5 kg) as an adult.

 *Medium Breeds* — The New Zealand, Californian, and Palomino breeds have an average adult weight of 10 lbs (4 1/2 kg).

 *Heavy Breeds* — The Flemish Giant can weigh over 14 lbs (6 1/2 kg) as an adult.

“Breeds can also be classified according to geographic origin. These breed origin classes are continental, regional, country and local. Examples of continental breeds of origin include: Africa—Giza White and Baladi; Asia—Japanese Large White and Sichuan White; Europe—Dutch and Burgundy Fawn; North America—Californian and New Zealand White, and South America—Criollo rabbits (*S.D. Lukefahr, the Rabbit Project Manual*).”

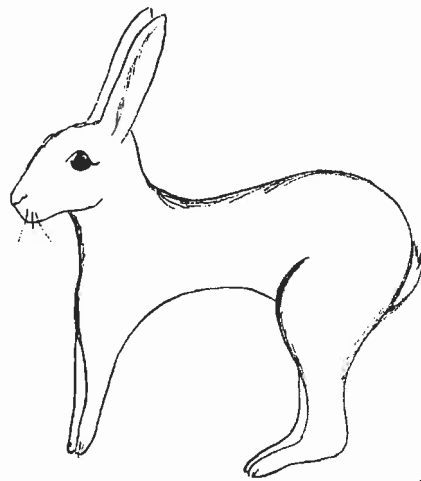

The “racy type” of hare (left) might be cute, but rabbit raisers prefer a compact body shape for meat production (below).

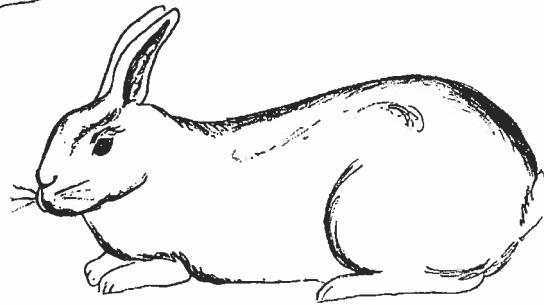

## The Hutch

The hutch detailed in Chapter 8 of this manual is one of many types ideal for medium-breed rabbits. It was designed and used successfully by the author. The following discussion presents some of the major factors to keep in mind while building a hutch—for example, protection from wind, rain, and sun.

Hutches can and do look very different from one area of the world to the next. There are no critical measurements which say that a hutch must be just so high or so long or it will not work, although there are size ranges that are better for certain types of rabbits. And there are design differences. For example, a hutch in a cold climate may have completely closed sides; a hot humid climate may suggest more open sides and greater overhang on the roof to increase ventilation.



Simple rabbit hutches can be constructed of many different things including milled wood, wire, split bamboo, raffia palm ribs, smooth sticks, woody vines, or a combination of these. However, all hutches, regardless of size or design, should provide:



plenty of fresh air



light to the inside of the cages



protection from rain and wind



a quiet, safe home (undisturbed by dogs)



a self-cleaning floor



a good roof that does not leak



a cage for each medium-breed rabbit



a water container for each rabbit

Most people prefer to build a hutch for one male (called a buck) and two females (called does), but some two-rabbit hutches (one buck and one doe) are also built.







It costs only a little more to build a hutch for three rabbits than to build a hutch for two. Two does will produce more young (and therefore increased meat yield), and the buck will not become lazy.

As the rabbit raiser gains experience more hutches can be built to house more does, as well as young rabbits being fattened for the table.

Each adult rabbit must have its own cage (or compartment). This is very important. Each cage for a medium-breed rabbit should measure about 75 cm (2 1/2 ft) wide, 1 m (3 ft) deep, and 60 cm (2 ft) high. A good rule of thumb is 2/3 sq meter per 1/2 kg (3/4 sq ft per lb) of body weight.

## Materials

Many different kinds of materials can be used to build a hutch. The following hutch (for medium-breed rabbits) was made using:

-  packing cases,
-  four eucalyptus poles,
-  14 strips of pine,
-  1 cm (1/2 in) square wire netting,
-  one flat sheet of galvanized iron, and
-  binding wire.

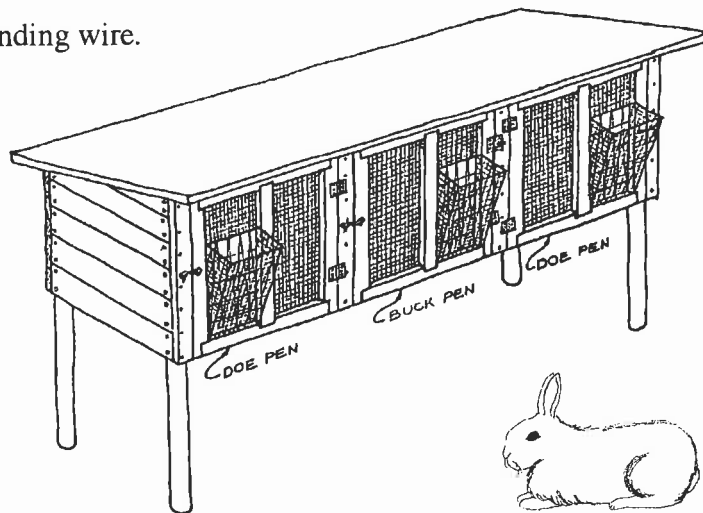

Rabbit hutches in Africa, Asia, and South America are often made of local materials. They are built close to the home, and if low to the ground, surrounded with a strong fence. The roof is usually made of thatch, the main supports of wood or bamboo, and the rest of the hutch made of bamboo (below).

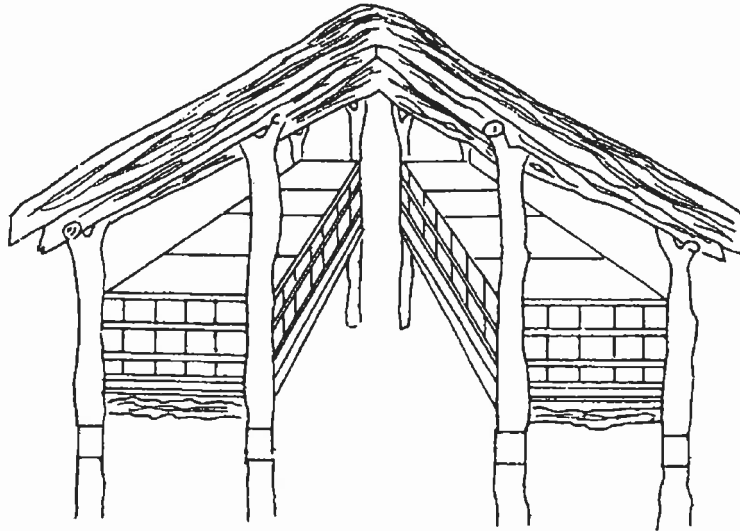

Hutches of this type are often constructed with a roll-back top. The roll-back top makes it easy to put in feed, water, and the nest box.

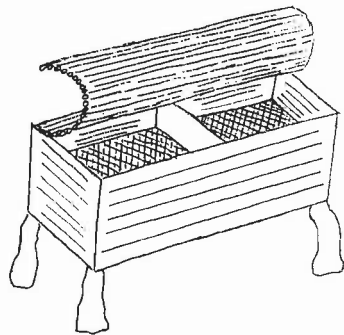

When building hutches with roll-back tops, you must be careful that you do not build the hutches too high off the ground. In many countries, young children are assigned the task of feeding and caring for the rabbits. The height of the hutches should make it easy for every member of the family to care for the rabbits.

In some countries a broad line of equipment specially designed for rabbits is available. This allows for the construction of all-wire hutches hung from an assembled iron framework. These types of

hutches are preferred by professional rabbit raisers, and can be cheaper to build in areas where lumber is very expensive. The wire hutch (below) is outfitted with modern feed hoppers and automatic waterers (Courtesy, Bob Bennett, *Raising Rabbits the Modern Way*, Storey Books, Pownal, Vermont USA).

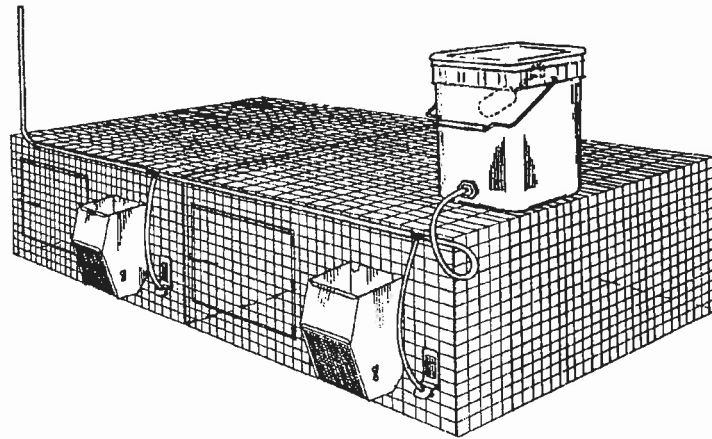

## Protection from Weather

The weather conditions that most affect rabbits are rain, sun, and heat. Rabbits often enjoy sitting in the sun, but they must always be able to get out of the direct rays of the sun. *Too much sun can cause mating failures and even kill rabbits.* Rabbits tolerate cold in their “fur coats” better than extreme heat. In very dry and hot locations, some rabbit raisers soak the ground below the hutches for evaporative cooling, and place dampened cloth or burlap sacks in the hutches. In some arid countries, like Egypt and Tunisia, rabbits are allowed to live underground. But, because it is almost impossible to keep the burrows clean and sanitary, young rabbits often become sick and die.

Rabbits must be protected from rain and wind. If the sides, front, or back of the hutch are covered only with wire netting, hang sheets of plastic or burlap sacks over these spaces during rains to protect the rabbits. However, rabbits need plenty of fresh air, so be sure to keep these drapes open as much as possible. Always

place the enclosed back of the hutch to the wind. Rabbits suffer when exposed to drafts. In severe winter, it is best to bring the hutch under the shelter of a roof (such as a corner of the barn) or under the eaves of the house.

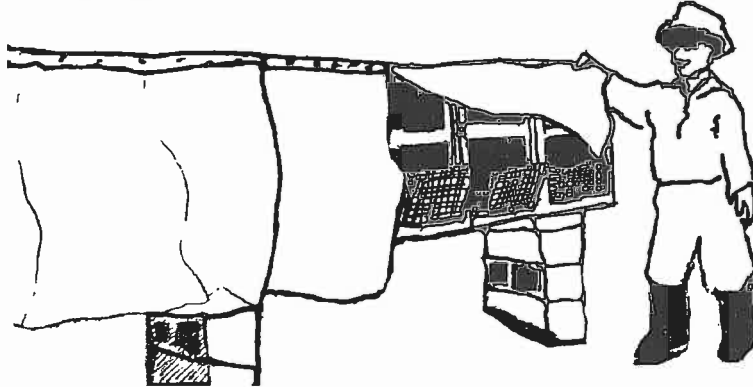

Protect rabbits from rain by hanging plastic sheets or burlap sacks in front of the hutch. Fold the covering back over the top of hutch during good weather to let in fresh air.

## Self-Cleaning Floors

Hutch floors must be “self-cleaning” to prevent disease.

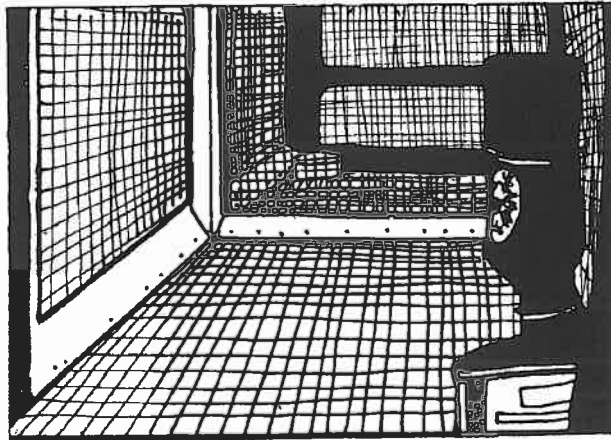

Manure will pass through the wire floor of this hutch.

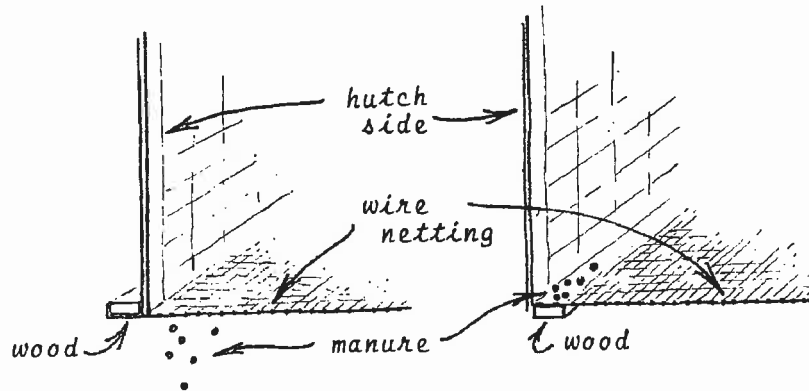

RIGHT — The manure will fall through the floor.

WRONG — The manure will collect on the piece of wood.

For convenience, the floor of the hutch should be no higher than waist high. Regardless of the materials you use, the floor should be self-cleaning. A self-cleaning floor can be made by stretching 1 cm (1/2 in) square wire netting in a frame. Wire floors help prevent rabbits from becoming sick and dying because manure and urine pass through the holes of the wire and drop to the ground. The inside of the hutch then stays, clean, dry, and sanitary.

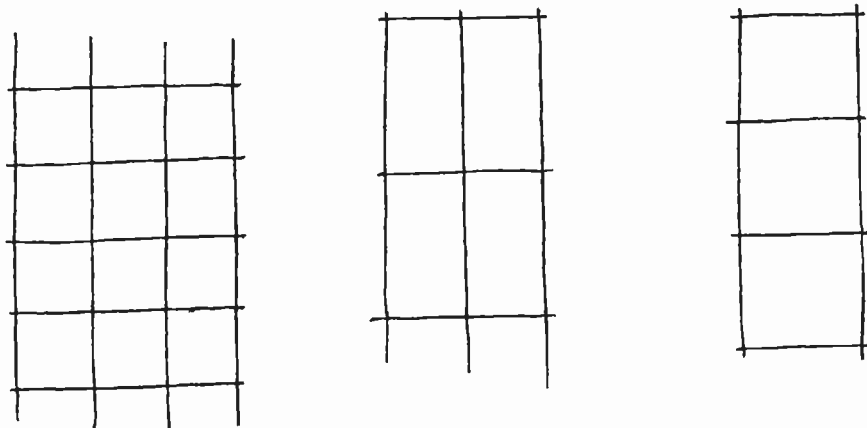

The three most common wire sizes used for flooring. Left — 1 cm (1/2 in) square — is good for most projects. Middle — 1 x 2 1/2 cm (1/2 x 1 in) — is the "ideal size," usually 16 gauge thick. Right — 2 cm (3/4 in) netting — is sometimes dangerous as young rabbits' legs can be broken by slipping through the holes of this size netting.

Self-cleaning floors can also be made of split bamboo, palm ribs, or sticks. Although floors of wire netting are the easiest to keep clean, floors made of split bamboo (smooth side up), palm ribs, and round sticks work well. In some respects, floors made from these natural materials have an advantage. A bamboo floor gives more support to the feet than a floor made of wire netting, so problems with sore feet (hocks) are minimized. However, care must be taken to run the slats from front to back with gaps about 2 centimeters so the manure pellets will fall through. The slats should not be spaced too far apart, or baby rabbits will slip through and fall to the ground.

The manure under the hutches should be gathered every few months and can be used on vegetable gardens. Rabbit manure is better than the manure of pigs, chickens, or cows for growing vegetables. Unlike chicken manure, which is considered too “hot” to use directly in the garden, rabbit manure can be mixed into the vegetable beds whenever an addition of fertilizer is needed.

## **Preparations for Feeding**

### **The Manger**

Rabbits can eat a lot of grass and leaves (forage). But these should never be scattered on the floor of the hutch. Greens on the floor of the hutch gets dirty with manure and urine, and this can make rabbits sick. It is easy to prevent this problem by building a simple manger, or feeding place, of wire netting or planks. This can be fastened to the outside or placed between two compartments of the hutch. The rabbits then pull the greens through the wire mesh and feed themselves as they are hungry. The manger should be large enough to hold plenty of grass and leaves.

Food being placed into a manger. Note the mesh which has been made by crossing pieces of wire. The holes are large enough for the rabbit to pull food through, but small enough to keep all but the tiniest rabbits from crawling into the manger.

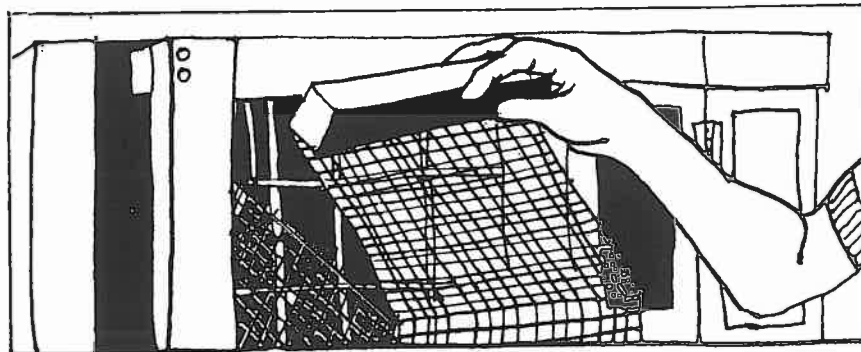
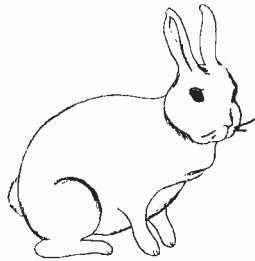
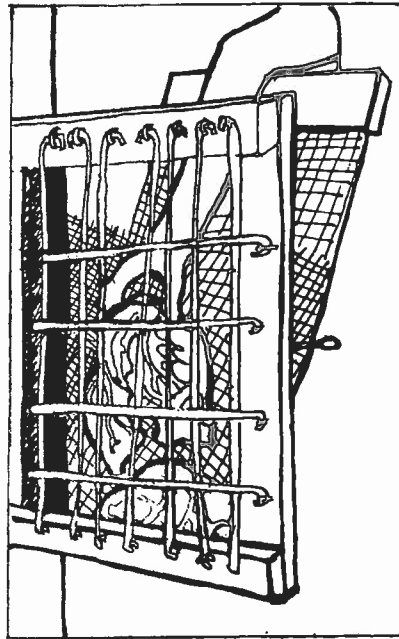

If you have a problem with baby rabbits crawling out of the cage into the manger, make a cover for it so the rabbits won't fall to the ground. A cover for a manger can be made by fastening a piece of wood to some wire mesh, which can drop or fasten into place.



It is not necessary to build a manger, but it *is* necessary to make the food available so that it is not lying on the hutch floor to get dirty. One way to do this is to tie grass and leaves in bundles with string or wire and hang it on the inside of the hutch near the front. This method will prevent the grass and leaves from becoming dirty or spoiled.

## Water

Rabbits need a lot of water. They get some water from eating grass and leaves, but they need more water than this. Make sure rabbits can get water whenever they wish to drink. Although heavy earthenware crocks with a flat broad base can be used, it is better to make an automatic water container.

To do this:



Turn a large bottle over and fasten it to the inside of the hutch so the lip of the bottle is inside a small tin can.  
*Make sure there are no sharp edges on the tin can.*



The lip of the bottle should be about 1 cm (1/2 in) below the top rim of the can.



Remove the bottle and fill the can and bottle with water.



Replace the bottle. As the rabbits drink water from the can, more water will fall from the bottle, thus providing them with a steady supply of clean, fresh water.

Fill the bottle as often as necessary to keep the water supply clean and fresh—probably at least once a day.

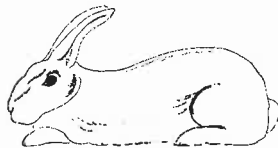

A simple bottle-and-tin automatic waterer.

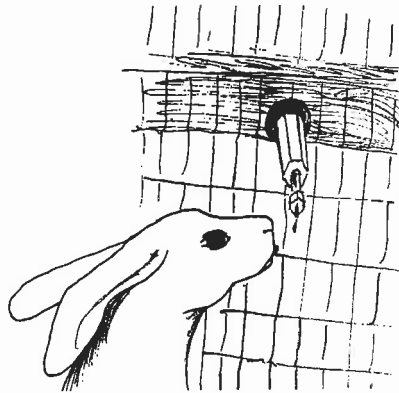
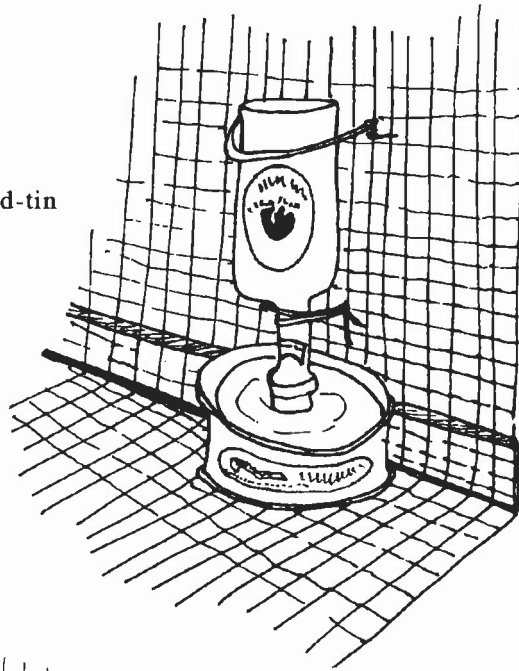

Professional rabbit raisers, caring for hundreds and thousands of rabbits, often install automatic watering systems using pipe and nipples.

## Feed Dishes

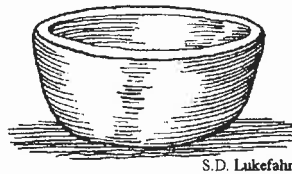

If possible select a heavy earthenware (clay) crock with about 8 cm (3 in) high sides. Heavy dishes cannot be tipped over by the rabbits. A coffee or butter tin can be used. Nail the can to a small board. Be sure there are no sharp edges on the can. Another

alternative is to use a split section of bamboo fastened to a small board to keep it from rolling.

Whatever kind of container you use, young rabbits will often climb into it. Usually rabbits will not urinate on their food but could contaminate it with their droppings. This will have to be watched and contaminated food thrown away.

If feed pellets are used, a feed hopper can be used like the one shown in Chapter 2, "The Hutch," or the model below. These have the advantage of always keeping the feed clean.

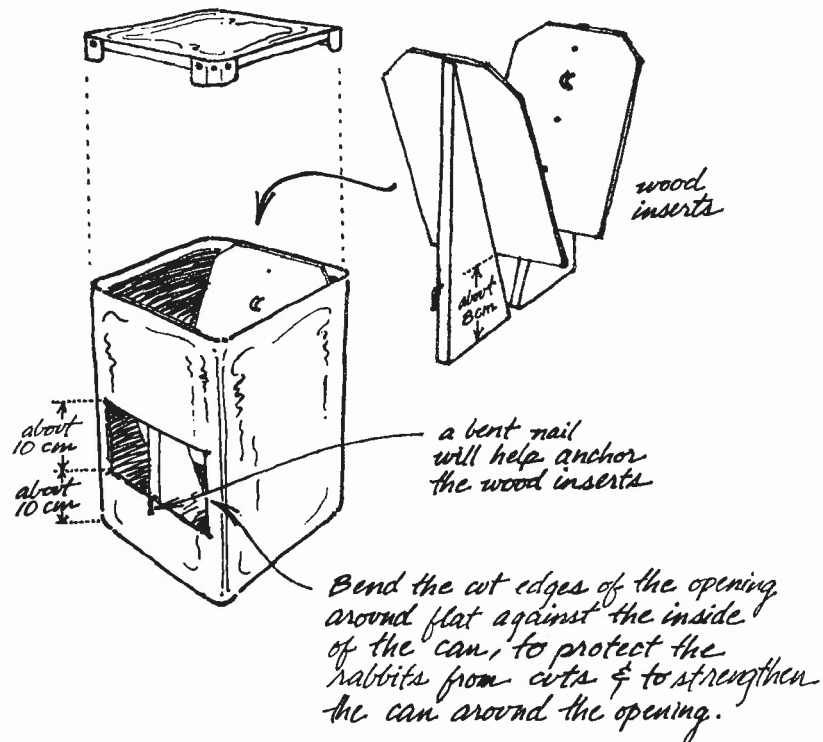

A feed hopper made from a square, metal 19 L (5 gal) tin and a few pieces of wood. Feed sits between the sides of the "V" shape piece and flows down toward the side opening.







## Caring For Rabbits

When the hutch is ready, the rabbit raiser can get started. This section presents guidelines for selecting, handling, and caring for rabbits.

### Check New Stock Carefully

The source of supply depends upon the area. In some places rabbits are available in the market, from another rabbit breeder, or perhaps from government sources. Wherever the rabbits come from, they must be checked very carefully before they are taken home. Remember that it is not possible to breed and raise healthy rabbits unless the rabbits you begin with are healthy rabbits.

You must be able to answer YES to all six of the following questions before you take the rabbit home:

-  Is the animal active and alert?
-  Are its eyes bright and clear?
-  Is its nose clean, not runny?
-  Are its ears clean and dry inside?
-  Is its fur smooth and clean?
-  Are its feet dry and free of sores?

If the rabbit fits these guidelines, ask about the litter from which the rabbit came. Choose rabbits that have come from large litters

and from females that have had good, large litters. Do not select brothers and sisters for breeding; they will not produce healthy young.

## **Handling Rabbits**

Rabbits are generally gentle and will not bite, but they do become frightened and can hurt themselves or the handler if they jump suddenly. It is always best to handle rabbits properly. Never lift rabbits by their ears or legs: they can be hurt if lifted this way.

### **Adult Rabbits**

There is plenty of loose skin at the back of the neck over the shoulders. Hold the rabbit by this loose skin with one hand and support its weight by placing your other hand under its rump (tail). Be sure to hold the rabbit's feet away from you to avoid scratches from the long toe-nails.

### **Small Rabbits**

Lift and carry small rabbits by holding them between the hips and the ribs. The heel of the hand should face the rabbit's tail; the rabbit's head should be pointed toward the ground.

### **Heavy Rabbits**

Grasp a fold of skin over the shoulder and lift. Hold the rabbit against your body with its head under your arm. The head should be in the armpit to cover the eyes. Covering the eyes tends to calm the animal. Your forearm should extend along the side of the animal, and your hand should be under the rabbit's rump to support the weight of the rabbit.



How to hold an adult rabbit.

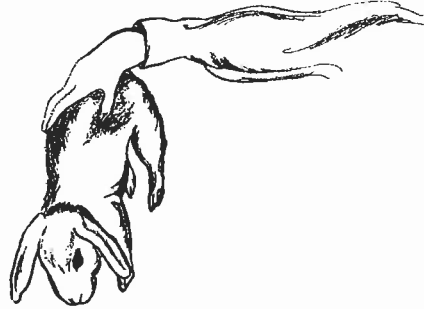

How to hold a small rabbit.



How to hold a heavy rabbit.

## Feeding Rabbits

Rabbits are not hard to feed because they can live on plants and other foods which are easy to find. Rabbits get the vitamins, minerals, and fiber they need by eating the leaves of plants. Maize (corn), peanuts, and other seeds can be eaten by rabbits and are good sources of protein. Crop residues, farm surplus foods,

agricultural by-products, and kitchen and market wastes can also be used.

It is important to feed rabbits well. Well-chosen food can help keep the rabbits free from disease while producing good growth at low cost. Breeding does must be especially well-fed to produce healthy young rabbits and the milk to feed them.

## **Elements in Foods**

### **Protein**

Protein is a substance which helps rabbits grow and stay healthy. Protein is contained in rabbit meat and is one reason why rabbit meat is so healthy to eat. Rabbits must be fed protein to produce protein.

Proteins from plants are best for rabbits. Rabbits can eat peanuts (groundnuts), sesame, linseed, hempseed, and cottonseed. These seeds are usually ground and added to rabbit mashes and pellets. Although soybeans are high in protein (36 percent), they are not enjoyed by rabbits unless the beans are ground into a meal or made into pellets.

Additionally, oil cake from soybeans, peanuts, sesame, flax, or cottonseed are good sources of protein.

### **Salt**

There is a noticeable difference in the amount of salt each rabbit consumes daily. For this reason, it is a good idea to place a block or spool of salt in each cage. Each rabbit will take what it needs by licking the salt.

Salt should not come in contact with metal cage parts, such as screening, because it will cause rusting and destroy them. Salt can

be added directly to the food in a quantity of 1/2 percent. If salt is added to the food, it is not necessary to use a salt block.

### **Vitamins**

Very little is known about a rabbit's requirement for vitamins, but rabbits do need vitamins A, D and E. Freshly cut green plants, some root crops, and high quality hay are excellent sources of vitamin A. The best source of vitamin D is found in cured roughages, especially field-cured lucerne. Fresh cut greens will also provide vitamin E. When labor and expense permit, rabbits should be given good quality green plants as part of their diet.

### **Minerals**

All dry and fresh green plants will contain some or all of the minerals needed by rabbits. If the rabbit's feed is properly balanced, there will be plenty of minerals for the rabbit.

### **Foods**

#### **Cereal Grains**

Rabbits will eat oats, wheat, barley, grain sorghums (milo, kafir, feterito, hegari, darso, and sagrain). These grains may be fed whole as soon as the young rabbits come out of the nest box at three weeks of age. Grains fed to rabbits should be plump and not spoiled or moldy. Soft varieties of maize (corn) can be eaten by rabbits, but the tougher, flintier types must be crushed or ground. Rabbits enjoy sunflower seeds, but these seeds are usually valued more for other purposes.

When rabbits are allowed to choose from several types of grain, their first choice will be oats, followed by soft varieties of wheat, grain sorghums, and barley.



Usually, it is a good idea to prepare a feed mixture which contains a number of grains. Here is one suggestion for a grain mix (the quantities are for a small number of rabbits — about three adults and their young):

 1 kg (2 1/4 lb) whole oats

 1 kg (2 1/4 lb) wheat

 1/2 kg (1 1/8 lb) crushed corn (soft varieties)

 1 kg (2 1/4 lb) soybean meal in pellet form

Nursing does should be full-fed (food continuously available) the grain mix. Dry does (females not nursing) and herd bucks (males) should be given as much as they will consume in 20–30 minutes.

Grains which are ground and made into a mash should be dampened with water before serving. Otherwise, dust will get into the rabbit's nose and cause irritation. When possible, feed should be made into pellets: there is less waste when pellets are used.

### **Green Feeds and Roots**

Rabbits enjoy green plants; tender cane tops have also been used with success. Rabbits also like sweet potatoes, carrots, sugar beets, turnips, and white potatoes. Some rabbit raisers maintain forage plots from which they harvest greens the year-round. Green plants and root crops contain protein, minerals, and vitamins; they are almost 90 percent water. These contents make them very important food for rabbits, particularly where other feed sources are scarce. However, if rabbits eat too many greens, they will not eat enough of concentrated feeds (like grain mixes). And these concentrated foods produce faster weight gain. Another point to remember is that feeding green feeds to animals that have diarrhea may worsen the situation.

*Never allow green feed to stand in piles and become heated before feeding it to rabbits.* Green feed which has been standing too long can cause serious digestive problems in the herd. Also, *never place greens on the floor of the cage* where they will become dirty. Disease is spread when greens are not hung up or placed in a manger.

### **Dried Plants (Hays)**

Lucerne, clover, peanut, lespedeza, vetch, and kudzu hays are excellent for rabbits. Hay must be of good quality: it should be leafy, small stemmed, green in color, free of dust and mold, and have a nice smell. Tender elephant grass and Sudan grass can be fed to rabbits but they contain less protein than the plants listed first. Rabbit raisers who maintain forage plots sometimes harvest any surplus and dry it for later use. However, in many countries weather conditions do not allow for the making or storing of hay. When hay is available, it can be placed before the rabbits at all times. They will eat about 55–85 gm (2–3 oz), daily.

### **Commercial Foods**

Many rabbit raisers prefer to buy a *complete* pelleted feed for their rabbits. With pellets it is easy to calculate how much to feed them and when. The packages should indicate the amount of protein, fat, etc. that they contain. The following chart shows how much of each of the listed substances rabbits require. If the concentrate contains these ingredients in about the same percentage amounts, it's considered a complete feed.

### **Suggested Rabbit Feed Analysis**

protein	15–20%
fat	3–5.5%
fiber	14–20%
nitrogen-free extract	44–50%
ash or mineral	4.5–6.5%

## **Coccidiostats**

Coccidiostats are preventive medicines for intestinal coccidiosis (see Chapter 6). However, they are of little value against hepatic (liver) coccidiosis. Coccidiostats can be added to the rabbits feed. A ration containing 0.025 percent of sulfaquinoxaline is effective for reducing the infestation of intestinal and liver types of coccidiosis in the herd. The use of medication should not take the place of good management. It is more economical to prevent than to cure coccidiosis.

Young rabbits are born free of this disease but may quickly become infected by licking their soiled feet, fur, or hutch equipment, or by eating feed or drinking water that is contaminated with the “eggs” (oocysts) of the disease organism (protozoans).

When rabbits are raised in areas where there is considerable humidity or long periods of rain or fog, the coccidia infestation may build up until it causes heavy losses. Manure pellets do not cause danger for 48 hours, but once they begin to break down or get mashed, the disease organism is released. Hutches with self-cleaning floors and proper food dispensors — plus good management practices — help reduce the possibilities of infection. Authorities on rabbit raising feel that it is impossible to get rid of the disease entirely, but they feel that good practices, such as those mentioned here, can reduce the problem considerably.

## **Other Foods**

Kitchen scraps, except greasy and spoiled food, are enjoyed by rabbits. By weight, dry or stale bread has about the same feeding value as the cereal grains. Bread can help reduce the cost of feeding rabbits. The fruits and rinds of oranges and grapefruits and the trimmings from vegetables can be fed to rabbits. Cow's or goat's milk is good for rabbits. Although poultry mash (formulated for growers and layers) is generally more expensive than rabbit feed, it is nutritionally adequate for homestead rabbits.

## A Note on Feed Storage

Keep feed dry and protect it against insects and rodents. Keep feed away from dogs and cats; they can be a source of tapeworm infestation if their urine or manure comes in contact with the feed.

## Proper Amounts and Combinations of Foods

Rabbits can be given a combination of foods as long as the total food intake is about the same. In general, herd bucks and dry does need only 1/8 L (1/2 cup) of concentrate each day; pregnant or nursing females require about 1/4 L (3/4–1 cup) per day.

### Bucks

Rabbits can be full-fed by leaving food in the hutch at all times. Rabbits fed by this method eat small amounts of food more often and gain weight more quickly. Herd bucks, however, should be hand fed. This means supplying them only with as much food as they can eat in 20–30 minutes. If herd bucks are allowed to eat all the time, they become fat and lazy. Two possible daily feeding plans for bucks are:



113–170 gm (4–6 oz) concentrate (depending upon weight), plus 15–minute feeding of greens

*or*



85 gm (3 oz) of grain mixture and all the good quality hay or greens they will eat

### Does

A doe at six months of age will eat at the rate of 3.8 percent of her live weight, daily. For example, a 4.5 kg (about 10 lb) doe will eat  $.038 \times 4.5 = .17 \text{ kg} = 170 \text{ gm}$  (or  $.038 \times 10 = .38 \text{ lb} = \text{about } 6 \text{ oz}$ ),

daily. If hay and grains are fed, she will consume 70 gm (2 1/2 oz) of grain mixture and about 100 gm (3 1/2 oz) of hay, to total 170 gm (6 oz).

The following chart is a good guide when feeding a combination of concentrate and greens:

### Concentrate/Greens Feeding Chart

Weight of Doe	Daily Ration
	45 gm (1 1/2 oz) or more greens, <i>plus</i> concentrate ration of:
2 1/4 kg (about 5 lb)	70–85 gm (2 1/2–3 oz)
4 1/2 kg (about 10 lb)	140–170 gm (5–6 oz)
6 3/4 kg (about 15 lb)	185–200 gm (6 1/2–7 oz)

*Note: The amount of concentrates can be reduced by increasing the amounts of greens fed.*

To feed a doe correctly, the rabbit raiser must know when she is pregnant. An experienced rabbit raiser can feel for the babies inside the mother at 14 days after mating (see Chapter 4, “Breeding Rabbits”). A doe must be given all the concentrates she will eat without waste while pregnant. After the young rabbits are born, continue to feed the doe and the young rabbits all the concentrates they will eat without waste. The doe’s diet should be reduced only when the young rabbits are removed and until pregnancy is noted again.

### Producing a 1 3/4 kg (4 lb) Fryer

Generally, it takes 7 kg (15 1/2 lb) of complete concentrate (pellets are best) to produce a 1 3/4 kg (4 lb) fryer in 8 weeks. The following chart shows four different feeding plans. This should help the rabbit raiser decide which plan is best for his situation.

Don't be discouraged if you don't produce a 1 3/4 kg (4 lb) fryer in 8 weeks, especially in a backyard situation. The highest quality stock (animals) and feeds are necessary to achieve this goal. The idea is to produce the most meat using the least amount of purchased feeds. A 2 kg average fryer weight attained at 4 months of age is considered good by many rabbit raisers, particularly when no feed concentrate or supplement is purchased. (See Chapter 9 for additional information on feeds and feeding.)

<b>Plan:</b>	<b>Concentrates</b>	<b>Luzerne Hay</b>	<b>Green Feed</b>	<b>Time</b>
<b>A</b>	7 kg (15 1/2 lb)	— —	— —	8 weeks
<b>B</b>	4 kg (8 3/4 lb)	1 1/2 kg (3 1/4 lb)	— —	8 weeks
<b>C</b>	4 1/2–5 kg (10–11 lb)	— —	1/2–1 kg (1–2 lb)	8 weeks
<b>D</b>	3 1/2–4 kg (8–9 lb)	— —	1 1/2–1 3/4 kg (3–4 lb)	10–11 wks

*Note: Amount of food to produce 1 3/4 kg (4 lb) fryer also includes a portion required for the doe from breeding through weaning.*

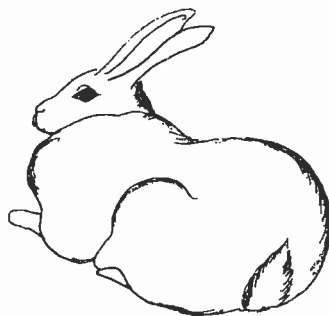

## Breeding Rabbits

When buying rabbits, find out how old they are. The minimum age for breeding depends upon the type of rabbit: heavy types take 9–12 months before they are old enough to breed; New Zealand Whites are ready to breed at 6–9 months of age. Many breeders in the United States use weight to determine when to breed their rabbits; New Zealands are bred at 3 3/4–4 kg (8 1/4–8 3/4 lb) regardless of age.

Do not breed females until they are old enough to handle the strain of nursing. One buck can service as many as ten does. Bucks can be used as often as they are willing with no ill effects. It was once thought that you could “wear out” a buck if he was used too often. It is now known that the need for limiting buck use is a myth. Under use is a much more serious problem—often resulting in a buck that is lazy and overweight.

It is usually best to breed does to the best buck available, except when such matings are brother-sister combinations. This is called “in-breeding” and should be avoided because it tends to fix characteristics—good and bad—more rapidly than other breeding methods. In some countries rabbit raisers maintain healthy stock and avoid in-breeding by exchanging unrelated bucks.

On the other hand, “line-breeding”—breeding father-daughter, father-grandmother, son-mother, and son-grandmother—often proves useful since it frequently strengthens desirable characteristics. However, the offspring from such matings must be closely examined because there may be unwanted defects present. Animals from two different lines (families) of line-bred stock often produce a new generation of animals that display an improved ability to live and a quicker rate of growth.

Mating two completely unrelated rabbits of the same breed is called "out-breeding." Out-breeding is often used to introduce new combinations of traits to a breeding line. Breeders that use this method carefully measure the offspring and keep records on the progress made toward developing the desired characteristics.

Remember, to produce good qualities, first identify the animals that carry the strengths you want and determine the breeding combinations that will produce the most desirable animals. A good breeding program requires close observation, knowledge of your rabbits, and identification of those traits that you wish to eliminate and those that you wish to strengthen.

## How To Mate Rabbits

The doe will probably object to having the buck placed in her cage and might attack or injure him. Therefore, *always* place the doe in the buck's cage for mating. Do not disturb the animals, and make sure people and dogs are not around. People and dogs can frighten the rabbits and they will not mate.

*Place the doe in the buck's cage*

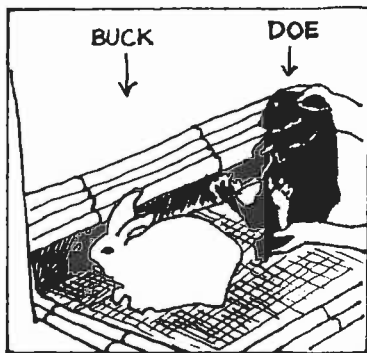

*The buck should mount the doe if undisturbed*

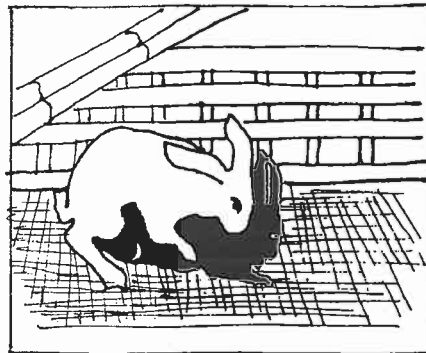

When the doe is placed in the buck's cage, he will probably mount her quickly. If after a few seconds the buck falls over on his side or



suddenly falls backwards, mating has taken place. Often when the buck falls, he will look as if his whole body has suddenly tightened. Allow only one or two falls. Then remove the doe and place her back in own cage.

*Do not let the doe stay with the buck all day long.* If mating has not occurred within the first few minutes, remove the doe and try again after a few hours. If left together for a long period of time they might fight.

As soon as the doe has been mated and returned to her cage, *write down the date of mating* on a small card attached high inside the hutch where the rabbit will not be able to chew it. If you fail to write down the date, you will not know when to feel for the young within the doe at 14 days or put a nest box in her cage before she gives birth.

### **Holding the Doe for Mating**



Sometimes a doe will hide in the corner of the buck's cage, and he will not be able to mount her. If this happens, help the buck by holding the doe for mating. This is very easy to do.

Use either hand to hold the ears and a fold of skin over the doe's shoulders. Place your other hand under her body and between her hind legs. Place one of your fingers on each side of the tail and push gently backwards. This action will throw the doe's tail up

over her back, so that the buck can quickly mount and mate her. If the doe's tail is down, the buck will not be able to mate her.

## Feeling For Young Rabbits

It is possible to feel the small, round babies inside the doe two weeks after breeding has taken place. Keep the doe in her cage. Hold her ears and a fold of skin over the shoulders as though holding the doe for mating. Slide the other hand under her stomach with your thumb on one side of the stomach and your fingers on the other. Gently press in on the stomach wall with your thumb and fingers and slide your hand backward and forward. If the doe is pregnant, you will be able to feel small, hard, marble-shaped lumps (bigger than manure pellets, about the size of ripe olives or grapes). This “test” is a good one, but must be practiced often to be successful.

## Kindling

Kindling is the act of giving birth. The doe will kindle 31–32 days after mating. A doe will probably eat less food two or three days before kindling. Four to five days before the kindling date, put a small box, called a nest box, inside the doe’s cage. She will give birth in this box. It is usually possible to find boxes which work very well, but if you must build a box, it should be lightweight and measure about 30 cm deep x 35 cm wide x 20–30 cm high (12 x 14 x 8–12 in).

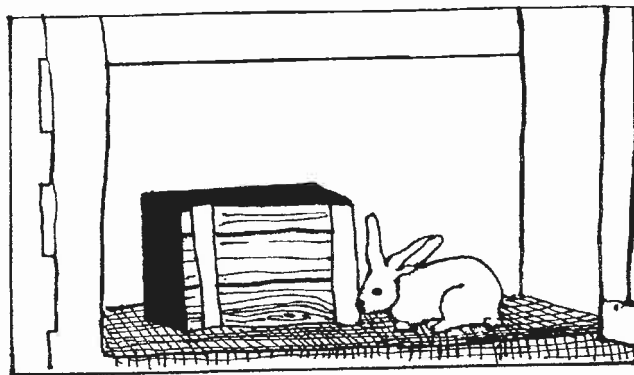

Place nothing in the nest box or the hutch if the weather is warm. The doe will pull fur from her stomach to make the box comfortable. If the weather is cold, place dry grass or straw in the hutch three days before kindling, and the doe will prepare her own nest.

Following are some examples of nest boxes you can make.

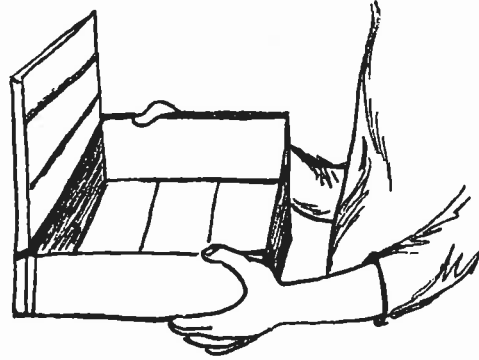

A simple raisin-case nest box. The cover has been turned up and nailed to one side of the case.

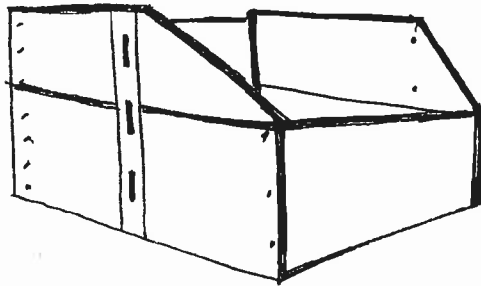

A nest box built with two raisin cases. This is a good box for nervous does who need more seclusion.

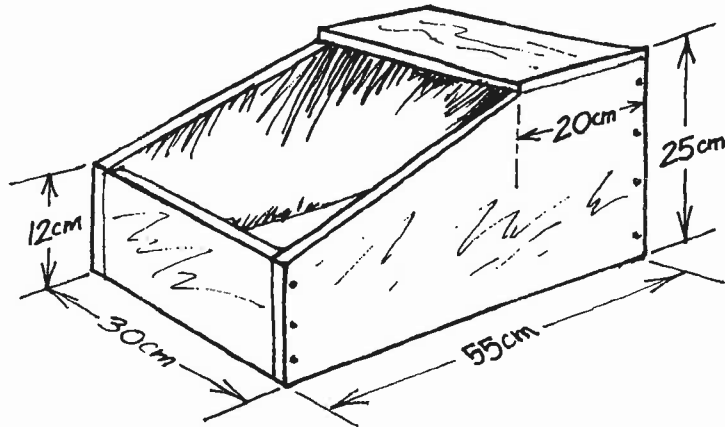

A winter nest box for medium breeds. 37

The closed-top winter nest box will hold the body warmth of the babies. These nest boxes can be made of 1 cm (1/2 in) or even 2 1/2 cm (1 in) lumber. One 1 1/4 x 2 1/2 m (4 x 8 ft) sheet of plywood will make four of these boxes, with just a little left over. Use wood for these boxes. If metal is used the box will “sweat” and create a health problem for the young rabbits.

The doe will use the top of the box to sit on. This allows her to get away from her young and keeps her feet warm. When the young are a few weeks old, they will start following the doe up to the top. Do not leave the nest box in the cage too long. The rabbits will quickly soil the wood surfaces and problems with coccidiosis could result (see Chapter 6, “Rabbit Diseases and their Control”). When the nest box is taken out of the cage, it should be scrubbed clean and dried in the sun before it is stored or used for another doe.

A nest box can also be made from a nail keg turned on its side and steadied with a piece of wood nailed across the front.

Does usually kindle at night. As each baby (kit) is born, the doe will lick it and give it milk. Does usually give birth to four or six kits the first time. After that, a doe usually produces six to eight kits at each kindling.

One or two days after the rabbits are born, carefully look inside the box for any dead kits. Move the fur to one side with a small stick or pencil. Remove any dead that you find.

When the doe is with her babies, it is important to keep children and dogs from bothering her. If the doe becomes frightened, she might injure her young by jumping into the box quickly and crushing them. And frightened does have been known to eat their babies. Does also will eat their young if they do not have enough protein food. If a doe continues to do this after a second or third time, however, she should be replaced.

## Weaning

Weaning means separating the kits from their mother. Young rabbits open their eyes 10–11 days after birth. They will come out of the nest box at about three weeks of age, and at this time they start eating food other than their mother's milk. The backyard rabbit raiser should remove the young from their mother at *eight weeks* and place them in another cage for fattening. If the young are separated before they are eight weeks old, they will stop gaining weight for a few days, and might even lose weight.

After weaning, breed the doe again. Wean and breed the doe on the same day. If the doe becomes pregnant each time she is bred, she can produce four litters in 12 months. But do not expect to reach this goal at first; it is sometimes difficult even for experienced rabbit raisers.

Especially strong, well-fed does, however, can be bred at six weeks after kindling. When this is done, the young should still stay with their mother for the full eight weeks before weaning. If the does are properly fed so they can stand the strain, this is a very good system of breeding. The doe is alone in her cage for only a short time before the next litter is kindled, and the hutch equipment is used to the best advantage. If you use this breeding schedule, you can expect each doe to produce five litters a year.

Breeding Schedule for 4, 5, & 6 Litters in a Year			
Litters per Doe per Year	Age to Wean Litter	Time to Rebreed Doe	Litter Interval
4	2 Months	2 Months	3 Months
5	1½-2 Months	1½ Months	2½ Months
6	2 Months	1 Month	2 Months

\* Based on Months of age of litter.  
\*\* Litter interval is the time between litters of the same doe. Interval is reduced if no misconceptions occur between litters.

Courtesy, S.D. Lukefahr, *the Rabbit Project Manual*, Heifer Project International, USA.

Some professional operations with access to high quality stock, a commercial diet source, ideal shelters, and medicines can produce even six litters a year. However, the productive lifespan of the does is usually only one year.

## Determining Sex



Determining the sex of a rabbit can be done at weaning time (eight weeks) or earlier, after you gain experience. Hold the young rabbit as shown *left* or place it on its back on a flat surface as shown *below*.

There are two openings near the tail. The opening nearest the tail is where the droppings come out. Above this is the outside opening of the sex organs. Place your thumb below this opening and your finger above it. Press down gently. You will see red, moist

flesh inside. As you press down you will see a *slit* or a *circle* with a small hole in the middle. If you see a slit, the rabbit is a female.



If you see a circle, the rabbit is a male. Sometimes at eight weeks the male's penis will protrude, so you will see more than just a circle.

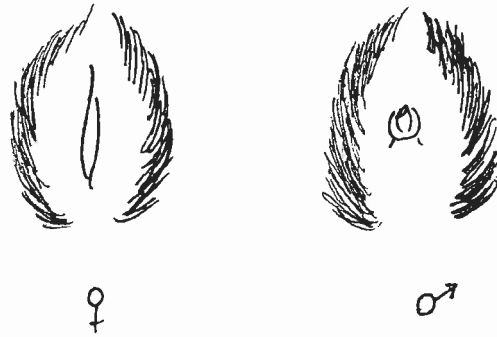

Appearance of the sex organs: female (left), male (right).

## Orphan Litters

Sometimes a doe dies at kindling or shortly afterward. Many rabbit breeders will not take time to raise orphan young, but young rabbits left without a doe can be fed whole cow or goat milk from a bottle until they are able to eat grains and grass at two weeks of age. When raising orphan litters, care must be taken to keep all feeding equipment sanitary.

## Balancing Litter Size

Some breeders mate several does at one time, so they will all kindle within a day or two of each other. If a doe has an exceptionally large litter (10–16) and another has a small litter (2–4), some of the rabbits from the large litter can be transferred to the smaller one. Orphan litters can similarly be handled in this manner. A litter of eight is an ideal size.

Handle young rabbits as little as possible, but do not worry about the scent of the human hand. As soon as the rabbits are placed in the nest box, any odor clinging to them is quickly destroyed.

## Failures To Conceive

The doe can be sterile (not able to produce young) if the food ration is unbalanced or the weather is too hot or too cold. High temperature stress can occur when the animals are exposed for prolonged periods of heat above 30°C. This can result in buck fertility problems. He may mate readily, but pregnancy does not occur. Under these conditions hutches should be constructed for maximum ventilation and placed in the shade. To provide evaporative cooling the ground under the hutches can be soaked and dampened cloths or burlap sacks can be hung inside the cages. Finally, remember to provide the rabbits with a steady supply of cool drinking water.

Bucks and does that are too old can account for conception misses. With excellent care and feeding a rabbit will remain profitable to breed for three to four years. After this time, does tend to give birth to small litters of two or three young.

A poor diet, sore hocks (feet) or other injuries can cause a loss of sexual vitality in both does and bucks. Rabbits *must* receive excellent care combined with proper management to achieve good breeding results.





## Keeping Records

If you are only raising rabbits in your backyard, you probably do not need to keep extensive records. The following forms should prove sufficient. However, once you get into a rabbit raising business, where keeping a production schedule becomes extremely important, more detailed records will be necessary.

The following basic sample records contain information essential to the careful rabbit raiser. Good records save time and allow planning of yearly production. Records are the key to successful breeding and handling of the litter. Make an individual record for each breeding animal and tack it somewhere in the cage where it will remain dry and won't be chewed on by the rabbit. In high humidity sometimes the cards become limp and blurry. If cellophane is available the cards can be covered to prevent this problem.

Animals which have been known to produce well for several years are of special interest to the rabbit raiser. Select rabbits from the litters of these outstanding does to keep aside for replacement stock.

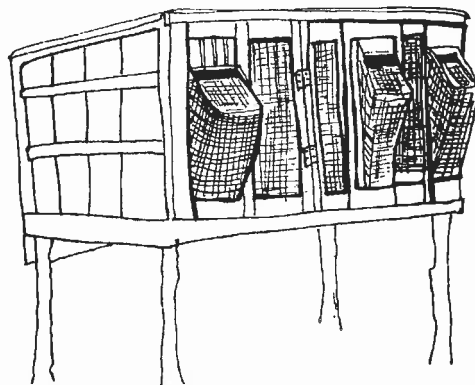

Place records high inside the hutch where they will be protected from rain and out of the rabbits reach.

## DOE RECORD

DOE NUMBER:	BORN:	BREED:	FATHER (SIRE):	MOTHER (DAM):		
1	Jan 3, '98	New Zealand	New Zealand, No. 2	New Zealand, No. 5		
BREEDING		KINDLED			WEANED	
Date of Breeding	Buck Number	Expected Date	Actual Date	Number Alive	Number Dead	Date
Jan 1, '99	1	Feb 1, '99	Feb 2, '99	8	0	April 4, '99

A sample doe record. Each rabbit has a name or number. The record shows: On 1 January 1999, the doe was bred by buck number 1. The expected day of kindling was 1 February 1999 (31 days), but she kindled on 2 February 1999. Eight babies were born alive; no dead ones. All babies lived to weaning on 4 April 1999 (8 weeks).

Some rabbit raisers include additional columns under KINDLED:

**Left:** When a litter is too large and you remove some of the kits from their mother, you can use this space to record how many kits were "left" behind.

**Added:** This column indicates the number of kits taken from another mother and added to this litter.

When a scale is available you can add a **Weight** column under WEANED to keep track of overall production.

BUCK RECORD					
BUCK NUMBER:	BORN:	BREED:	FATHER (SIRE):	MOTHER (DAM):	
1	March 10, 1978	New Zealand	New Zealand, No. 6	New Zealand, No. 12	
Doe Number	Date of Breeding	Result of Breeding -- Kindled		Number Weaned	Notes
		Alive	Dead		
1	Jan 1, 1999	8	0	8	BUCK is an active breeder

A sample buck record. Use this record only if you have more than one buck. If you have only one buck, you will know how the buck is doing by looking at the doe record. Even when a breeding record is not kept, his number, date born, breed, sire and dam (father and mother) should be written on a small card and hung in his cage. If many bucks are used for breeding, an individual breeding record should be kept for each. If scales are available a weight column can be added after NUMBER WEANED.

## Common Rabbit Diseases And Their Control

It is best to prevent disease; treating disease is often difficult. Following these simple rules can do much toward keeping rabbits free from disease:



Keep hutch, nest boxes, water cans, and mangers *clean*. Dry brush hutch and feeders every morning. Clean wire floors with soap and water, or a solution of a bleaching product, like Clorox, Cresyl, Izal (1 ml per liter of water), after each litter.



Give rabbits fresh food to eat. Remove stale food from the cage or mangers.



Protect rabbits from intense sun, rain, and drafts.



Keep unfriendly dogs away.



When possible use wire netting for hutch floors. Hutch floors should always be self-cleaning.



Take sick rabbits away from the other rabbits immediately.



Watch for signs of the following diseases.

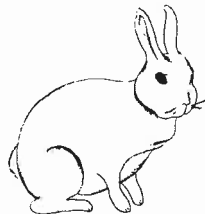

# **Abscesses**

## **Cause**

Bacterial infection introduced from a puncture or scratch from another rabbit or from a sharp object such as small sharp burrs on the cage wire or a piece of wire. These abscesses are frequently due to a spread of the snuffles bacterial organism, *pasteurella*.

## **Signs**

A well-developed lump (abscess) can occur almost any place on the rabbit's body. The most common areas are under the skin (subcutaneously), under the chin into the dewlap (fold of skin under the neck), between the front legs, on the back or the belly, and in the internal organs of the thorax or abdomen.

## **Treatment**

Allow adequate time for the abscess to soften and come to a head. The hair will fall out or easily pull out over the lump, leaving shiny skin with a soft center. Lance it open and squeeze and drain the pus from it. Then liberally use hydrogen peroxide or a good disinfectant, flushing well down into the opened abscess pocket. Keep the incision open to ensure complete drainage. Treat daily for 7 to 10 days, allowing the abscess to heal slowly from inside out to the skin incision. If skin is allowed to heal over too soon, these areas frequently re-abscess. An intramuscular dose of penicillin may be helpful after the abscess has been lanced and drained.

## **Prevention**

Do not overcrowd rabbits. Watch them closely after weaning — they are growing rapidly and easily become overcrowded. Do not keep future breeders in the same cage after they are 3 months old; with some breeds, even 3 months is too long. If the rabbits fight

through the wire, put a divider between cages. Remove any sharp objects from the hutch, and file or sand off all sharp cage wire burrs. It is a good management policy to cull rabbits that have abscesses.

## **Buck Teeth**

### **Cause**

Usually hereditary; on a rare occasion it may result from an injury such as pulling a tooth loose on wire, or from the animal not eating enough to wear down the front teeth evenly. Incisor teeth continue to grow throughout a rabbit's life; if the upper teeth do not touch the lower teeth (malocclusion), they cannot wear the opposite teeth down.

### **Signs**

One or more of the front teeth grow longer than the others, making it difficult for the animal to eat.

### **Treatment**

Clip the teeth evenly, using a dog's toenail clippers or wire cutters and file with an emery board if they crack off on sharp projections. To avoid getting into the nerve, do not clip any more than normal tooth length. Watch to see if the animal is able to eat effectively. There may also be a malocclusion of the molars and the rabbit will slobber and have difficulties eating. Teeth grow very rapidly, so routinely clip off excess incisor teeth every 1 to 2 months.

### **Prevention**

Do not breed animals that have buck teeth. Cull out all animals with this hereditary trait.

## **Caked Breast (Caked Udder)**

### **Cause**

Milk not being taken from the breasts fast enough. Doe may have too few young, or not be letting them nurse.

### **Signs**

In early cases, the breasts (one or more) are firm, pink, and feel hot to the touch. Later on, little knots can be felt in the breasts. Following this, the breasts may darken and become dry and cracked.

### **Treatment**

Reduce concentrates and provide plenty of green feed and clean water. Rub Lanolin (or oil or some other kind of skin-softening agent) well into the breasts and try to get milk to flow by massaging and encouraging young to nurse. If breasts crack, soften crusts and allow to drain, but do not lance with a knife.

If breasts start getting blue, the doe should have antibiotic injections (penicillin) at once. Isolate the doe and wash your hands thoroughly before taking care of other does.

### **Prevention**

Do not wean all the young rabbits from heavily milking does at the same time; take a few at a time from her. Breed heavy milkers a few days before weaning the young. If a heavy milker loses a litter, breed her again at once. Breeding helps to reduce the milk in the breasts.

# Coccidiosis, Liver and Intestinal

## Cause

A one-celled animal parasite living in the rabbit's liver or intestines.

## Signs

*Liver Form:* spotted liver; small, yellow abscesses scattered throughout the liver. *Intestinal form:* the animal may suffer from a loss of appetite, diarrhea, loss of weight; it may frequently grind its teeth and often sits in a hunched position. Many rabbits with a light infestation of coccidiosis show no signs of the disease.

## Treatment

Only quinoxaline is approved by the government in the United States of America. However, in other countries Mecryl Powder, Sulphamezathine, Amprol, and Eimryl Urgence are often used. These medicines are usually placed in the rabbit's drinking water. Commercial poultry coccidiosis dosages are effective and work well for the intestinal form of coccidiosis, but the spotted-liver form of coccidiosis is difficult to treat effectively.

## Prevention

Practice strict and regular sanitary management of cages and equipment. Keep hutches and cages clean of urine and droppings. Keep feeders clean. At least once a week, scrub floor surfaces and feeders with a solution of one part household ammonia diluted with ten parts water to disinfect and remove the buildup of organisms and filth. The intestinal form of this parasite is usually present in most rabbits, but the animal only develops clinical signs when conditions favorable to the parasite exist. Coccidiosis lowers



a rabbit's body defenses, making it more susceptible to other rabbit diseases.

Housing rabbits on a wire floor is very helpful. The hutch should be kept clean at all times: one dirty corner in the hutch could lead to an outbreak of this disease. If the hutch floor netting is stretched tight, there will be little need for additional supports. If you must use wood supports, build them as shown below.

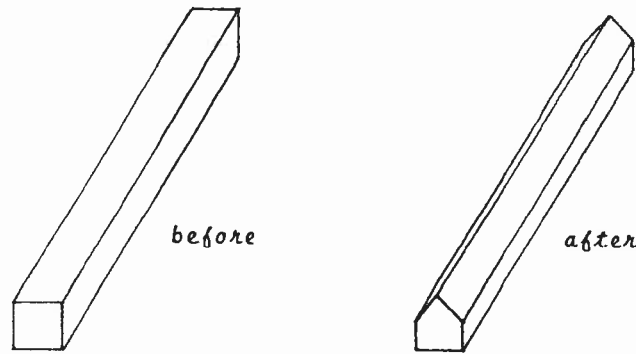

With only a pointed or knife edge supporting the wire, droppings will fall away on each side of the wood and keep the floor clean.

Coccidia eggs passed in the feces (manure droppings) are not infectious for one to three days, so elimination of manure contamination of the feeders, waterers, and nest boxes is an effective method of control. Try to select does that keep a clean cage and nest box. Cull (remove from herd) all rabbits from the litter of a doe diagnosed with a spotted-liver form of coccidiosis.

## **Colds or Snuffles**

### **Cause**

Bacterial infection (pasteurellosis) is a latent infection in the majority of rabbits, but incidence may increase due to any stress such as sudden change of weather, fluctuating environmental

temperatures, poor ventilation, drafts, dietary deficiencies, or movement from one place to another.

## **Signs**

The animal may sneeze or have a runny nose and weeping eyes, developing into a discharge of whitish to yellow pus. The rabbit wipes its nose with its paws, causing matting of the fur on the inside of the front feet. The majority of infections are an upper respiratory sinusitis; pneumonia may be a primary or secondary infection and cause difficulty in breathing. Infections may involve the middle ear (wry neck), uterus, mesenteric lymph nodes, lungs, and subcutaneous abscesses.

## **Treatment**

Try to eliminate stress conditions. Attempt to ease the animal's breathing by keeping its nose clean. Keep the animal eating by bribing it with greens and roughages. Rubbing the nasal cavities sometimes helps break congestion and allows it to drain. Humanely destroy an animal having a severe case of snuffles. Antibiotics are usually not effective.

## **Prevention**

Cull rabbits with snuffles.

## **Remarks**

This disease often attacks animals in over-crowded, damp, dirty hutches. Protect rabbits from rain.

# **Ear Mange or Ear Canker**

## **Cause**

Infestation of ear mites too small to see by the naked eye.

## Signs

A brownish-red, scabby crustiness develops inside the ear canal. Sometimes the ear droops and the rabbit may scratch it.

## Treatment

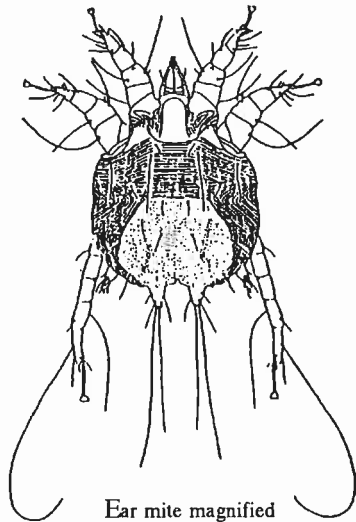

Ear mite magnified about 100 times.

There are several effective commercial miticides; or go to a pharmacy and ask for a solution of 0.25 percent Lindane in vegetable oil or a mixture of 2 parts iodoform, 10 parts ether, and 25 parts vegetable oil. In parts of West Africa people use a mixture of palm oil and kerosene (237 mL (1 cup) oil to a few drops of kerosene). Apply the medication at the top of the crusty area inside the ear and allow it to drain down into the ear, massaging the base of the ear to help work the medication down into the ear. Also treat the scabbiness at

the uppermost tip of the ear and around the margins and base of the ear.

Never put objects down into the ear to dig out the scabbiness; you may harm the inner ear structures.

As the medication kills the mites, the rabbit may shake its head vigorously to remove dead mites. A repeated medication schedule is needed to break the life cycle of the ear mites — mite eggs, which are resistant to miticides, can live as long as 30 days before hatching. Check and re-apply the medication once a week for 4 weeks.

Regularly check your animals for ear mange. Do not confuse this problem with wax, which is common in most rabbit's ears.

## **Prevention**

Do not allow fur to build up around the cages and in the rabbitry; mites and mite eggs may become attached to loose hair and float around in the air and infest other rabbits.

## **Enteritis, Nospecific and Mucoid**

*See intestinal coccidiosis.*

### **Cause**

Sudden changes in diet, spoiled food, low-quality, low-fiber and high-protein food, stress conditions, bacteria, virus, or internal parasites may cause intestinal inflammation or infection.

### **Signs**

Droppings may be semi-solid to liquid and often like a jelly. The rabbit goes off feed. The eyes become very dull and appear lifeless. The belly appears distended. The hindquarters and vent area often become matted and dirty with feces. The animal often sits crouched in a corner and grinds its teeth. If you pick up an animal with mucoid enteropathy (enteritis) and shake it, it sounds much like a half-full jug of water due to the liquid in the belly.

### **Treatment**

The above condition does not respond well to medication because the primary cause is not known, although the stress induced by poor rabbit husbandry practices increase the incidence of the condition. Good husbandry practices, including good sanitation, high-quality diet, regular feeding schedule, free-choice of clean, fresh water, and lowering of the incidence of coccidiosis will eliminate many causes that may lead to this condition. Mucoid does not respond satisfactorily to known methods of treatment,

but may be helped by removing all feed for 24 hours and then changing to a diet of all roughages, such as stemmy legume hay for 5 days.

### **Prevention**

Regularly sanitize and keep waterers, feeders, and cages clean. Do not overfeed, and keep the level of coccidiosis as low as possible. Keep clean water available at all times. Do not feed diets with protein in excess of 15 to 16 percent or fiber less than 16 percent.

## **Hutch Burn**

### **Cause**

Filth from urine and droppings in the cage floor sticking to and matting the hair around the tail and vent area.

### **Signs**

The animal suffers from an inflammation of the external genital organs.

### **Treatment**

Use water and a mild, non-irritating soap to gently soak off and clean the area. Then apply ointment to soothe the irritated skin. An intramuscular injection of penicillin for 3 days may be helpful in severe cases to reduce the systemic spread of infection.

### **Prevention**

This condition directly results from rabbits having to live in a filthy environment. Keep the areas clean and disinfect the floor whenever buildup occurs. Never breed an animal that has hutch burn.

# **Mastitis**

## **Cause**

Bacterial or fungal infections that enter through the nipple or abrasions, scratches, and puncture wounds over the breasts.

## **Signs**

The nipple line becomes caked, feverish, and dark in color; commonly referred to as “blue breast.”

## **Treatment**

For 3 days, give the doe the recommended intramuscular doses of Procaine Penicillin G, 20,000 units per pound of body weight. This treatment may help in some penicillin-sensitive bacterial infections, but it is of no value in controlling other types of mastitis. Hot packs and poultices are often helpful. Allow the doe time for complete recovery from the infection before breeding her again; if mastitis recurs with the next litter, cull the doe. Mastitis may develop into an abscess.

## **Prevention**

Keep the cage, nest box, and any other items that might come in contact with the doe’s nipple line clean and free of infection-causing agents. Make sure there are no rough spots or sharp projections that might injure the breasts as the doe jumps in and out of the nest box or moves around the cage.

Never foster out babies from a doe that has mastitis; the baby rabbits are carriers and can spread the mastitis to the foster doe. If the babies are too young to wean, it is usually best to dispose of them. You can try hand feeding the babies, but unfortunately many of them will have a bacteremia from their mother’s mastitic milk and die.

# **Myxomatosis**

## **Cause**

Virus disease transmitted by blood-sucking insects, especially the mosquito.

## **Signs**

Inflammation and swelling of eyes, ears, nose, and genitals accompanied by a high fever. If these signs are present, most of the animals die within 3 to 5 days. Pneumonia or pasteurellosis may develop as a secondary infection and there is a discharge of pus from the nose and ears.

## **Treatment**

There is no known treatment.

## **Prevention**

Practice strict insect control around the rabbitry and isolation of infected stock. A screened-in rabbitry plus regular use of insecticides is the most satisfactory method of reducing exposure of rabbits to blood-sucking insects. Vaccinate all stock 8 weeks of age or older against this disease if you live in an area where the disease is common. The stresses involved in being handled and vaccinated can sometimes give rabbits, with signs of snuffles (pasteurellosis), pneumonia which may be fatal. A few rabbits vaccinated in the face of an outbreak of this virus may develop myxomatosis. The immunity is short term (up to 9 months) and you may need to vaccinate twice a year, spring and fall, before the mosquito season. Myxomatosis is fatal and may wipe out an entire herd if you do not take precautionary measures.

A few rabbits may survive the disease. After 10 to 14 days, they may develop wart-like lesions around the face, ears, and over the body in the areas where they were bitten by the mosquito. These

lesions contain high levels of the virus and are highly infectious if a mosquito should feed from the wart and then bite another rabbit. Quickly cull animals with lesions if they are suffering, or quarantine them with netting around the cage to avoid mosquito biting and further spread of the virus.

## **Pneumonia**

### **Cause**

Bacterial infections, viruses, sudden chills, drafts, or inhalation of dust or liquids. While pneumonia may be the primary disease, it is quite often a secondary condition to another ailment.

### **Signs**

Congestion in one or both lungs causes labored breathing. The animal may refuse to eat, has difficulty in breathing, and extends its head while trying to breathe. Body temperature, as shown by a thermometer placed in the rectum, may be high (39.5-41°C or 103-106°F). As the animal gets worse, the eyes and ears may show a bluish color because of lack of oxygen. There is often a discharge of pus from the nose and, later, a crusty covering over the nose that makes breathing even more difficult.

Sometimes death occurs quite quickly without any of these signs. At other times, the animal may linger; in that case it should be humanely destroyed.

### **Treatment**

Giving the animal antibiotics or sulfonamides in the feed, water, or orally, or as an intramuscular injection, may sometimes help. A veterinarian will usually give 200,000 units plus 0.25 gm dihydrostreptomycin intra-muscularly in the hind leg. Continue medication for 3 to 5 days to allow effective levels to get into the rabbit's system and fight the infection.



## **Remarks**

The critical time for the doe is two weeks before and two weeks after kindling. Watch the doe closely during these times. Pneumonia also can follow right after many of the other diseases. Watch for it. Treat and isolate infected animals promptly.

## **Ringworm**

### **Cause**

Fungus “favus.”

### **Signs**

Usually a round, dry, crusty scab accompanied by a loss of hair.

### **Treatment**

Use a fungicide such as tincture of iodine. The fungus spreads from the outside rim of the circle so, when treating individual lesions, medicate an area slightly larger than the area of hair loss.

### **Caution**

While this form of ringworm is rarely contagious to humans, avoid contact with the infected area. After treating an infected animal, wash your hands thoroughly before handling another animal because the fungus may be very contagious from rabbit to rabbit.

## **Skin Mange and Lice**

### **Cause**

Mites that burrow under the skin, or chewing-sucking lice on the surface of the skin.

## **Signs**

A crustiness or a dandruff-like scaliness develops on the skin, usually on the back of the neck or around the margins of the ears and on the side of the face.

## **Treatment**

Use a dusting powder (such as dry flowers of sulfur) or liquid that will kill external parasites. Re-apply the powder or liquid in 7 to 10 days to break the life cycle of the parasites. Always thoroughly clean and spray the rabbitry with an insecticide to prevent re-infestation.

## **Caution**

Always carefully read and follow directions on the container bottle.

## **Sore Hocks**

### **Cause**

Poor flooring; rough wire on the cage floor; burrs or pieces of metal sticking up from the floor; nails protruding up into the flooring; floors that sag too much. Some people think there is a hereditary factor in some strains and breeds whose fur padding and skin are very thin, causing sores where the bone pushes against the skin as the rabbit sits in the cage; this pressure reduces the blood circulation and sores develop.

### **Signs**

Bruised, scabby, abscessed, or raw bleeding areas, usually seen on the hind foot pads but sometimes on the front pads.

## **Treatment**

Place the animal on lath flooring, on a flat board placed over the wire in the corner of the cage, or on the ground if the area is enclosed and clean (using indoor-outdoor carpeting is also helpful). Apply sulfonamide powder directly on the wound, and sprinkle it on the board the animal rests on. Zinc ointment and sulfathiazole ointment are sometimes used to treat the wounds. Do not use so much that the foot becomes sticky and picks up dirt.

Clean the remaining fur around the wound to help ease the pressure and promote healing. An injection of penicillin may help prevent the spread of the infection (bacteremia) throughout the bloodstream and the development of abscesses in other locations of the body.

Sore hocks often do not heal and are quite painful; if this happens, it is best to humanely destroy any affected rabbits.

## **Prevention**

Observe and run your hands over the flooring of the hutch to be sure there are no protruding wires, sharp burrs, or nails to injure the animal. Only breed those animals that have well-developed fully furred pads on their feet. Cull an animal with a severe case of sore hocks. Watch for recurring cases from a particular strain as this ailment may be a hereditary problem. It is usually better not to use an animal with sore hocks for breeding. Keep rabbits undisturbed so they do not bang their feet. Select replacement stock from quiet animals.

## **Caution**

Sore hocks develop into a secondary bacterial infection if not found in time and treated correctly.

## **Vent Disease or Rabbit Syphilis**

### **Cause**

A venereal disease.

### **Signs**

Infertility, resorptions, abortions, stillbirths, small litters, blisters, scabs, weeping lesions, and loss of hair around the vent (vulva or penis). These lesions may also appear on the rabbit's lips, nose, eyelids, ears, and feet. These same signs can occur with skin mange and hutch burn, so have a veterinary diagnostic laboratory make a positive diagnosis by testing the rabbit's blood serum for presence of rabbit syphilis antibody.

### **Treatment**

Rabbit syphilis responds to one intramuscular injection of penicillin. Inject the rabbit with Procaine Penicillin G, 20,000 units per pound of body weight. Most rabbits recover from the disease and can be used for breeding. Immunity does not follow recovery.

## **Wet Dewlap (fold of skin under neck)**

### **Cause**

Usually due to dragging the dewlap in a water crock.

### **Signs**

If the dewlap is always wet, a moist dermatitis (skin irritation) develops under the throat, sometimes turning the area green due to the growth of organisms.

## **Treatment**

Clip all the wet dewlap fur right up to the throat. Then apply a lubricant ointment to the reddened skin. Continue treatment until the area begins to dry and heal.

## **Prevention**

Place a brick or rock in the middle of the water crock to make it difficult for the rabbit to drag its dewlap in the water. Use automatic watering devices.

## **Wry Neck**

### **Cause**

Inner ear infection, sometimes caused by an injury, but usually an infection due to the bacteria *Pasteurella multocida* that travel from the upper respiratory tract up the eustachian tube into the middle and inner ear.

### **Signs**

The head twists to one side and may continue to get worse until the animal loses its sense of balance and rolls over; this is due to damage of the balance mechanisms and nerves of the vestibular apparatus in the inner ear.

### **Treatment**

There is no satisfactory treatment; it is best to humanely destroy infected animals.

*Source: University of California, Division of Agriculture and Natural Resources, Oakland, California USA and Raising Rabbits, H. Attfield, VITA, USA.*

## Killing, Skinning, and Tanning Rabbits

Animals are killed when they reach the desired market weight. In many cases, getting the meat is more important than worrying about the skin. When possible, rabbits are kept longer, gaining weight at a slower rate, so that they can be kept until the combined value of the meat (carcass) and pelt (skin) will bring the highest return.

In the United States, 80 percent of the rabbits marketed are classed as “fryers.” This means the meat is tender and suitable for quicker cooking methods. To become classified as fryers, medium and heavy breeds of rabbits are weaned and marketed at two months of age, when their weight averages 1 3/4–2 kg (3 3/4–4 1/2 lb). The meat that you actually are able to “dress” out of the animal — or fryer yield of the carcass — will average from 50 to 60 percent of the live weight. In countries where the dehaired skins and heads are eaten the carcass yield may differ.

At the time of slaughter there should be some fat over the ribs, along the backbone, in the flanks, and around the tailhead and the kidneys, increasing the dressing percent over that of the thin rabbit. To accomplish this, rabbits must be properly fed. Small bones and thin skin show quality in an animal. Because of this, medium breeds with small bones and thin skin will give higher dressing percent than ones with large bones and thick skins.

The amount of food in the stomach and intestines has an effect on dressing percent. If the rabbit is without food and water for a few hours before killing, the dressing percent will be lower.

The profit you get from a fryer will depend on how much feed and labor cost you have to subtract from the fryer's market price.

## Killing And Skinning A Rabbit



Rabbits are easier to kill and clean than any other farm animals. With experience, the whole job can be done in two or three minutes! Follow these steps:

Kill the rabbit quickly and painlessly. Hold it by the hind legs, head pointing down. In a few seconds he will stop struggling and hang quietly. With the edge of the palm of your free hand (or with a pipe or stick), give a quick "chopping" blow to the back of its neck. This blow will kill the rabbit quickly without pain.

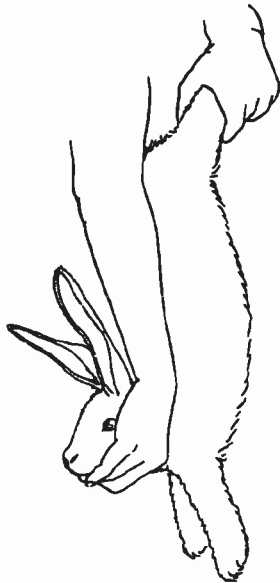

Some people prefer dislocating the neck to kill a rabbit. The operation is faster than the blow to the neck and well suited to the commercial rabbit raiser. Hold the rabbit by the hind legs with one hand. The thumb of the other hand is placed on the neck just behind the ears, with the fingers grasping the neck. Pressing down on the thumb while quickly pulling the rabbit upwards dislocates the neck.

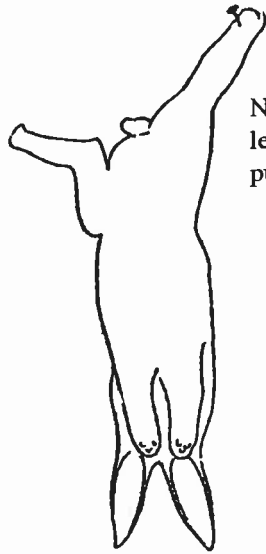

Next, hang the rabbit by one of the hind legs using a piece of rope or twine, or by putting a large nail through the hind leg.

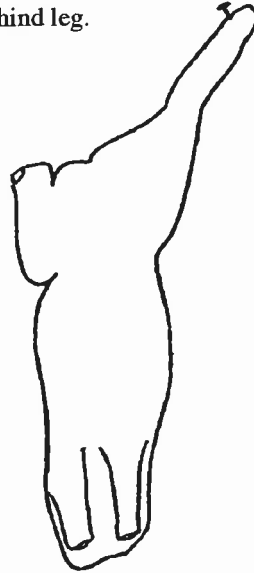

After this, cut off the head, front feet, and the one hind foot not attached by rope or nail.

Now, cut the skin on the inside of the leg of the foot attached by the rope or nail. Continue this cut to the tail and up the other leg.

Line of cut: from hock to hock around anus.

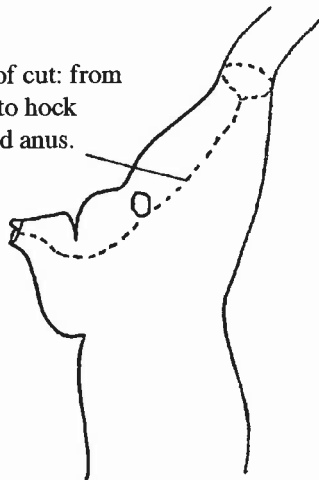

Complete the cut to the hock of the other leg.

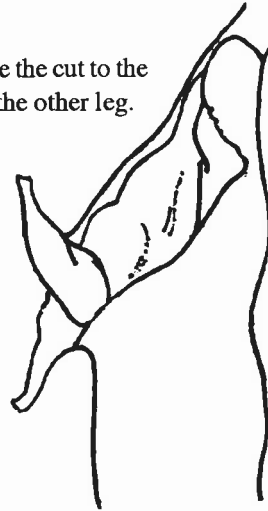



Peel the skin off both hind legs and cut the tail off. Start pulling the skin down.



If this is not a fryer, it will be necessary to cut some while pulling the skin down. Connective tissue forms between the skin and muscles starting at about 10 weeks. If these connections aren't cut, the muscles may be pulled off with the skin.



After the skin has been pulled completely off the body, cut the bone that holds the two hind legs together. Then slit the body of the rabbit down the middle of the belly, but do not cut the intestines.



To finish, remove everything except the kidneys, liver, and heart, which are good to eat. Be sure to pinch or cut the gallbladder away from the liver before cooking. Cut up the carcass or cook whole.

The carcass is often cut into seven pieces. "To serve more people, the larger carcass can be cut into twelve servings if you cut the

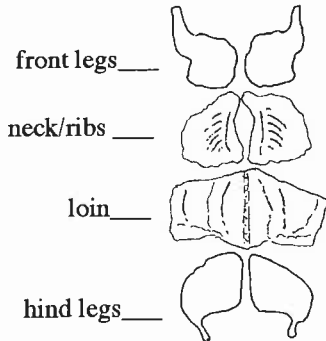

hind legs into two pieces, the loins and back portion of the ribs into five pieces, and the front portion of the ribs and each of the front legs into one serving each (*J.I. McNitt, et al, Rabbit Production, USA*).” It should be noted that 8 week old rabbits are best cooked quickly, either fried or cooked on an open flame. However, older rabbits which are tougher and more flavorful are better for dishes

that require longer cooking like stews and curries. In some countries the head, dehaired skin and intestines (tripe) are also eaten.

## Tanning A Rabbit Skin

In the introduction to this book it was said that many beautiful items could be made with rabbit skins. Rabbit skins must be tanned (treated so they will be soft and durable) before they can be used to make hats, rugs, and other articles. This is not very difficult to do and one method follows.



Take the skin and slit it up the middle of the belly. Tack it on a board or the side of the house with the fur side down and the skin side up.



The following day examine the skin to see if it is drying flat. Remove any patches of fat or meat. Let the skin dry completely.



After the skin is dry, soak it in clean, cool water. Change the water several times. When the skin is soft, lay it over

a pole or board and work over the skin side with a coarse file or dull knife to remove any tissue, flesh or fat. This will also remove any grease or oil. All the fat and oil must be out of the skin before continuing.



Now put the skin in warm water with 30 gm (about 1 oz) of soda or borax to the gallon (3.8 liters). Get soda or borax at the pharmacy. Add a little soap to help remove the grease and clean the skin. Wash the skin in this mixture and then remove the skin. Squeeze the water out of the skin slowly and carefully.



Wash the skin in a little gasoline which will remove the last bits of dirt and grease.



Now the skin is ready to be preserved with chemicals (tanned). You will need about .45 kg (1 lb) of ammonia alum (ammonia aluminum sulfate) or potash alum (potassium aluminum sulfate) to dissolve in one gallon (3.8 liters) of water. After this, add about 110 gm (4 oz) washing soda and about 225 gm (8 oz) of salt in 1/2 gallon (2 liters) of water. Pour the soda-salt-water mixture slowly into the alum-water mixture while stirring well.



Take about one cup (237 mL) of this mixture and add baking flour until you make a thin paste. Tack out the skin smoothly with the fur side down. Put the paste on the skin side about 1/2 cm (1/4 in) thick. Lay a piece of paper or cloth over it.



The next day scrape off most of the paste and put some more on again. Repeat this for two more days. (Repeat for only one more day if the skin is from a young, 2–3 month old rabbit.)



Now put another layer of paste on and leave it for four days.



Finally, scrape off the paste and wash the skin in a gallon (3.8 liters) of water with about 30 gm (1 oz) of soda or borax. Rinse the skin in cool water. Squeeze out all the water and stretch the skin in all directions. Pull the skin side back and forth over the edge of a board. Much of the success in making a soft skin depends upon this repeated work. After you have worked the skin for a long time it will become soft and dry. It is now ready to be made into beautiful rugs, hats, handbags, or collars for dresses.

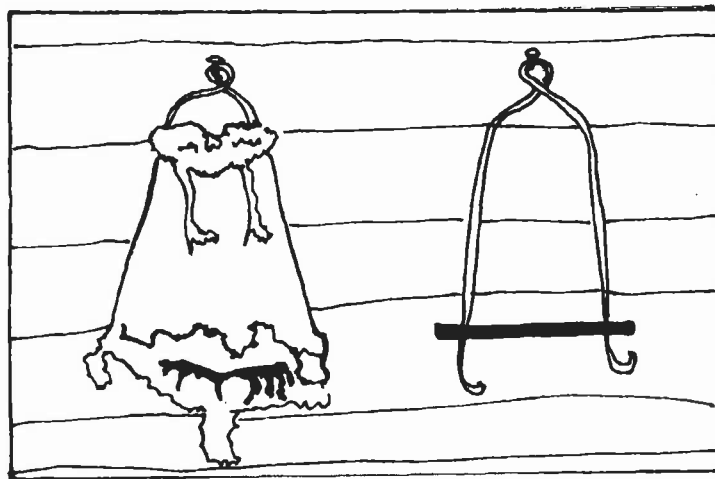

Rabbit skins can be stretched over wire, flesh side out, and kept dry for several months before tanning.

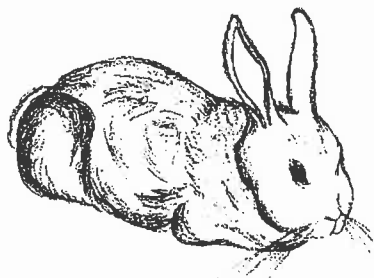

## Hutch Construction

Detailed step-by-step instructions for building a wood hutch with a wire mesh floor and a sheet metal roof are presented first. Following are a few sketches and notes on a variation on this basic hutch design, made with a wood frame and bamboo sides and roof. Both hutches provide good living and breeding space for rabbits.

VITA Volunteer George R. Clark has prepared these construction steps from plans provided by Harlan Attfield.

*Note: 1 cm is approximately equal to 0.4 in.*

### WOOD HUTCH WITH METAL ROOF

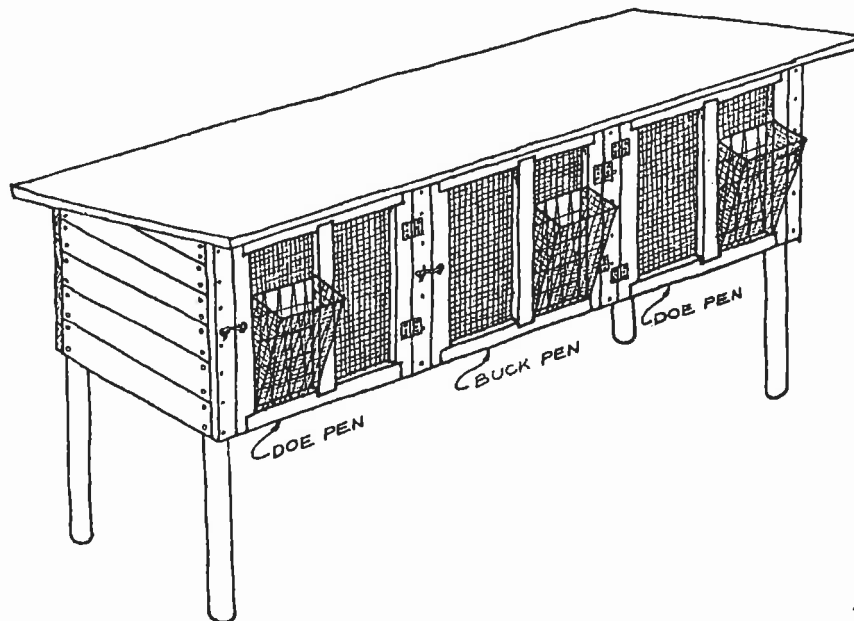

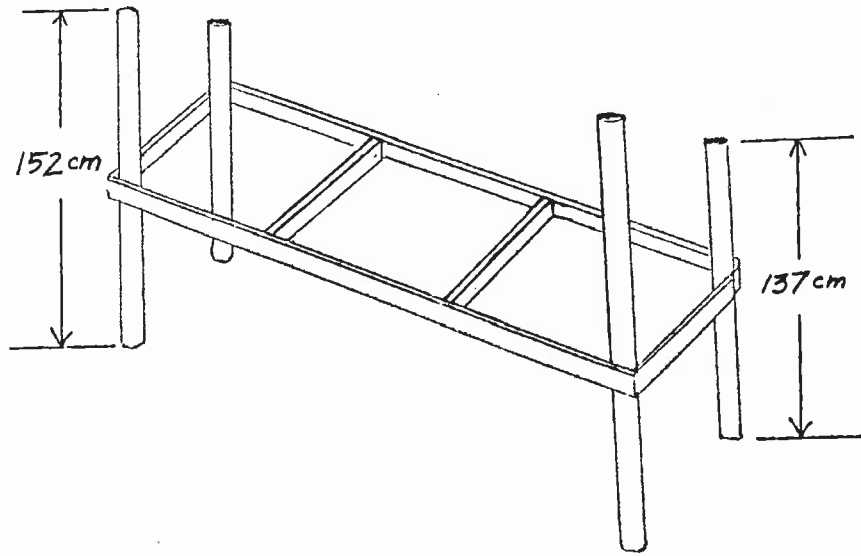

When building the base of the hutch, be sure all edges on floor are flush, so all rabbit droppings fall to the ground.

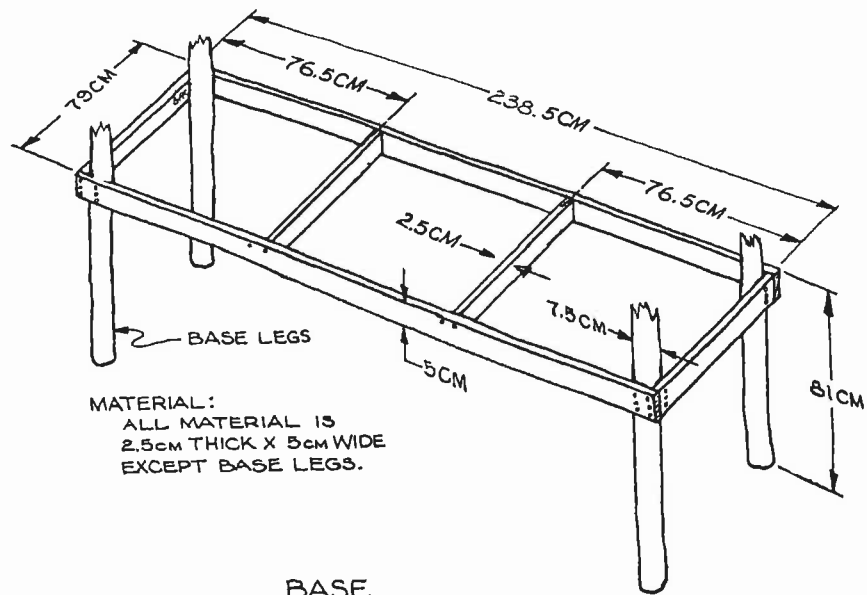

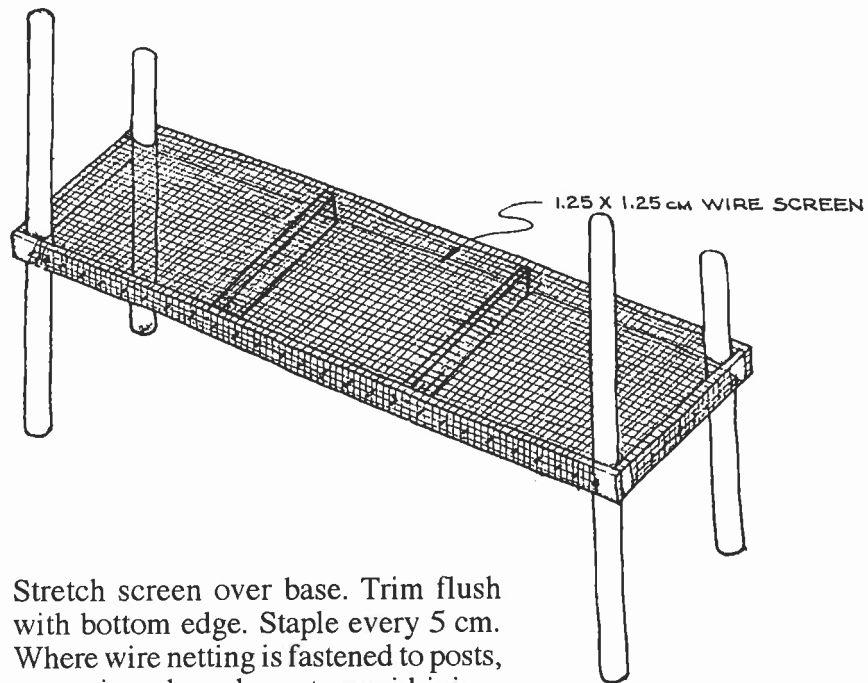

Stretch screen over base. Trim flush with bottom edge. Staple every 5 cm. Where wire netting is fastened to posts, turn wire edges down to avoid injury to the rabbits.

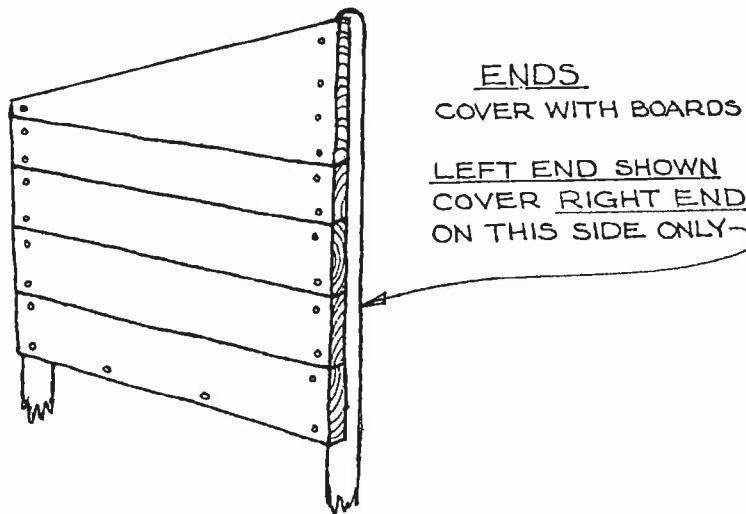

Option for covering the ends.

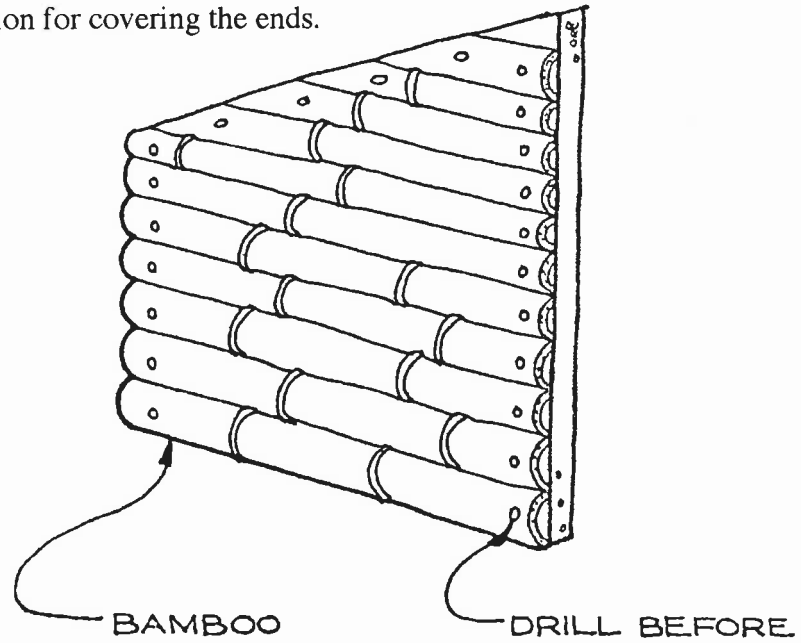

Some builders prefer to install reinforced end panels, as shown below.

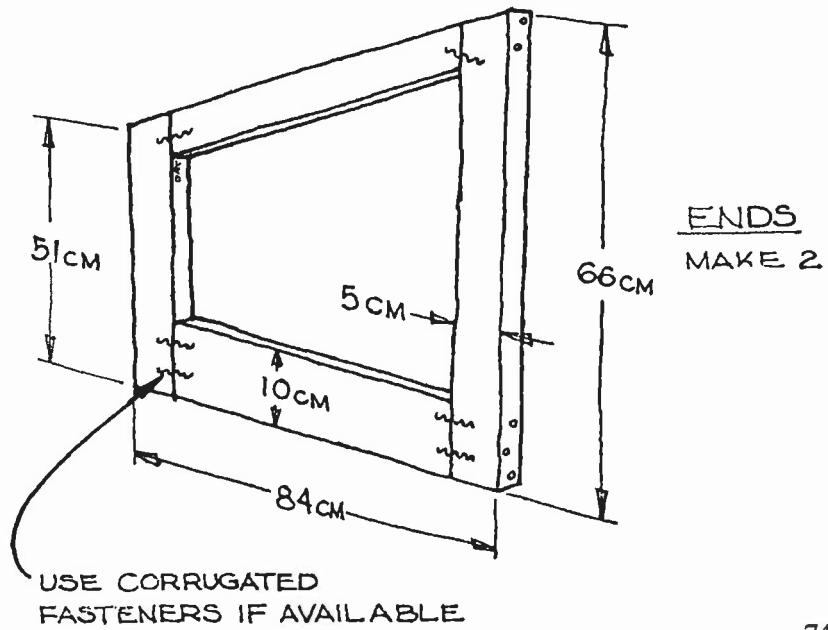



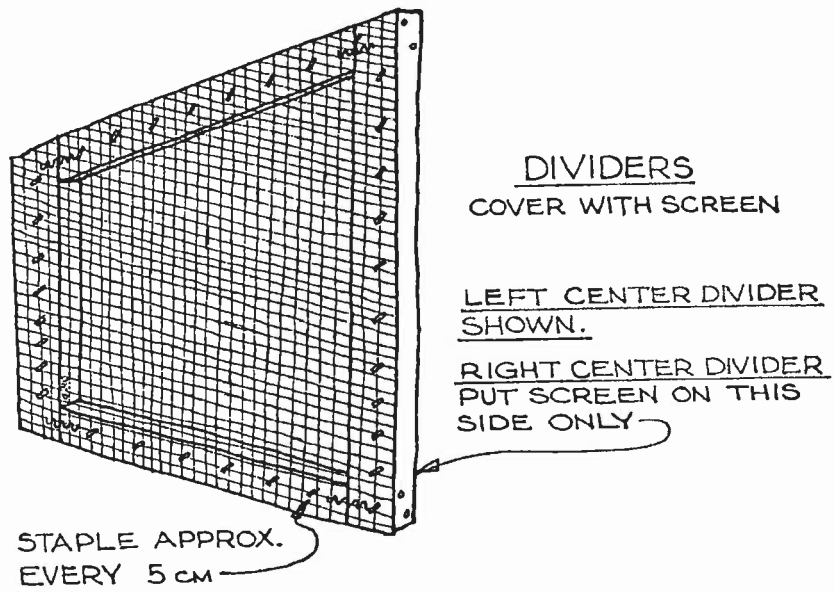
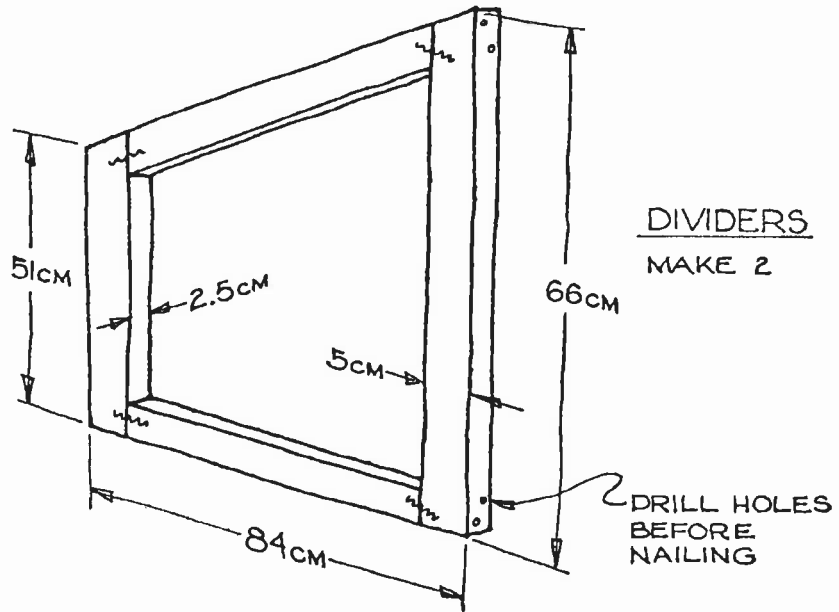

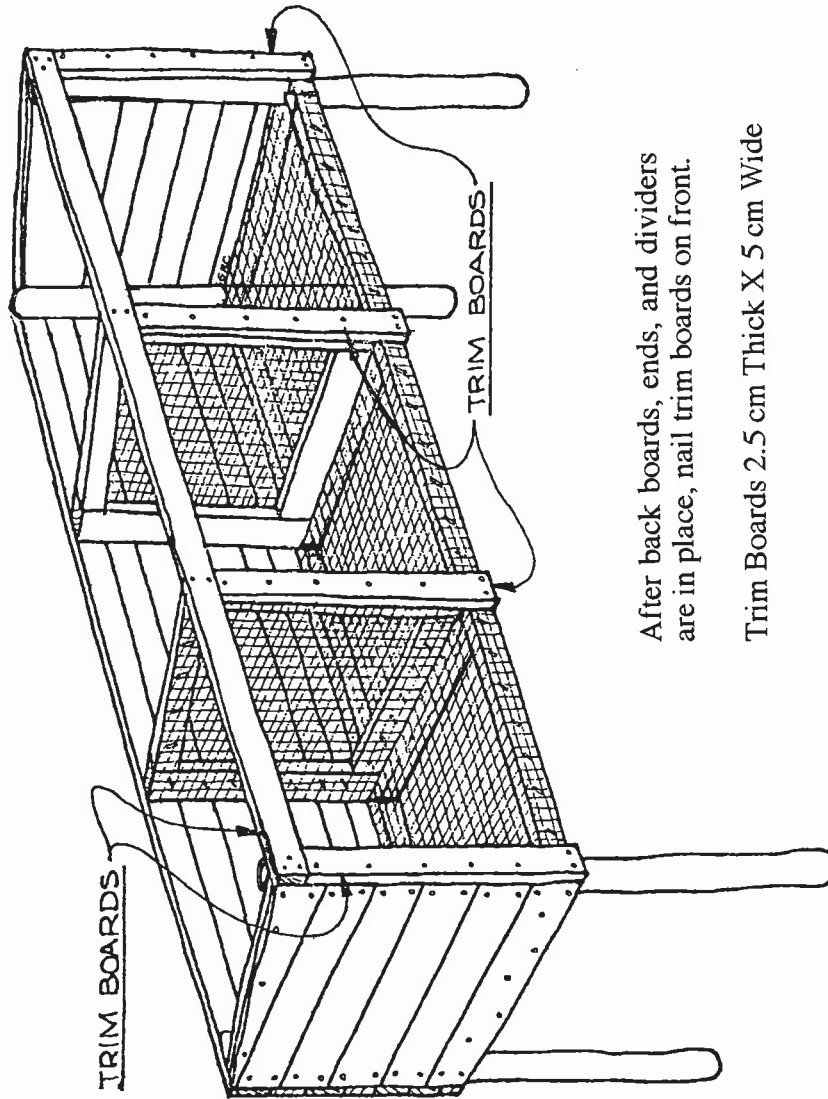

After back boards, ends, and dividers are in place, nail trim boards on front.

Trim Boards 2.5 cm Thick X 5 cm Wide

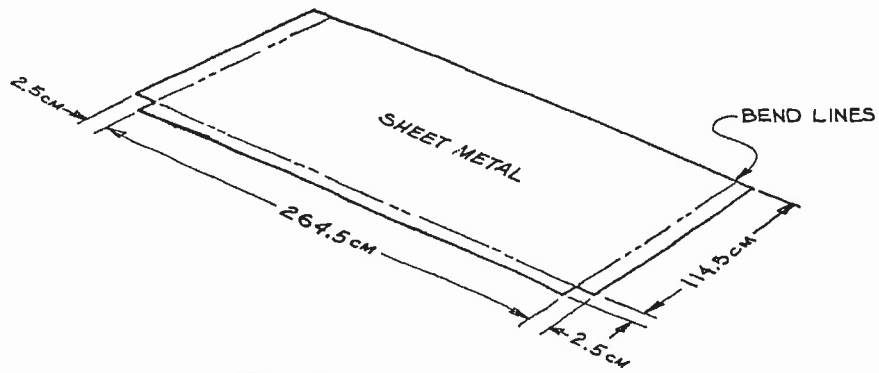

METAL HUTCH ROOF

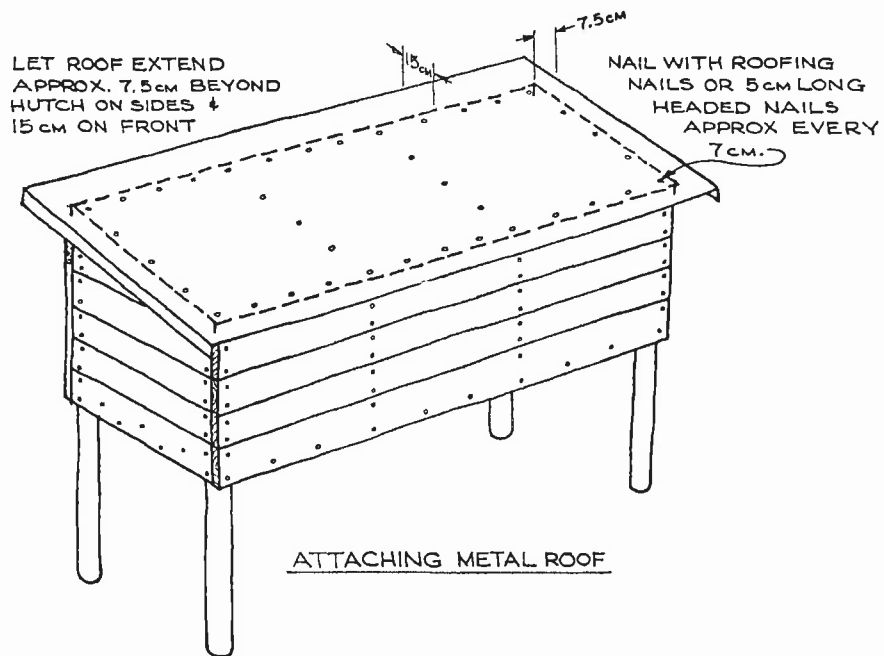

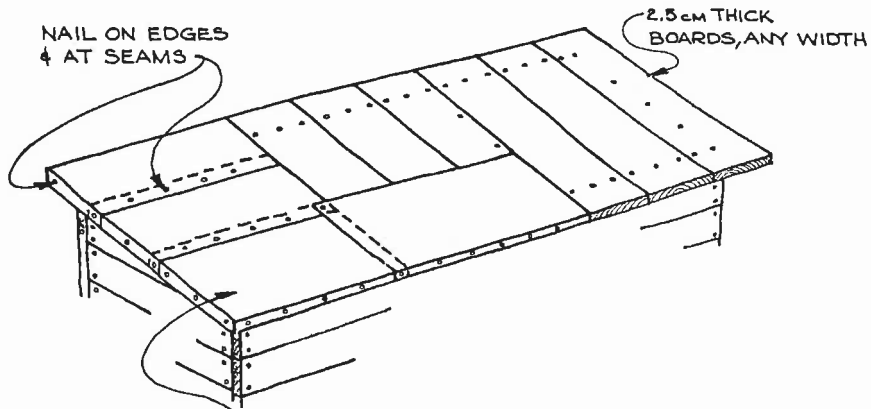

TIN CONTAINERS  
CUT OPEN & FLATTENED.  
START ROW AT BOTTOM  
BACK & WORK UP ROOF  
OVERLAPPING SEAMS ABOUT  
5cm. SEAMS MAY BE COATED  
WITH PITCH OR ROOFING  
CEMENT BEFORE NAILING,  
IF AVAILABLE.

### ALTERNATE ROOF FOR HUTCH

## Door Frames

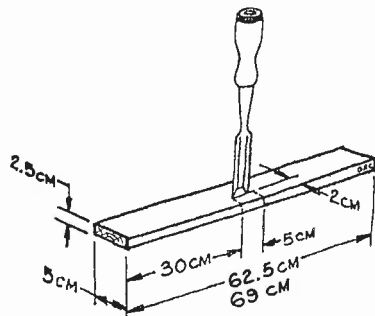
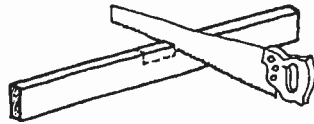

### STEPS

1. CUT BOARDS TO WIDTH & LENGTH.
2. MEASURE OFF POSITION & SIZE OF NOTCH.
3. MAKE SAW CUTS.
4. CHISEL OUT MATERIAL BETWEEN SAW CUTS

### MATERIAL:

- 2.5 X 5cm
- MAKE 2 PIECES 62.5 LONG
- MAKE 4 PIECES 69 LONG

### CUTTING DETAILS FOR DOOR FRAME PARTS TOP & BOTTOM FRAME MEMBERS

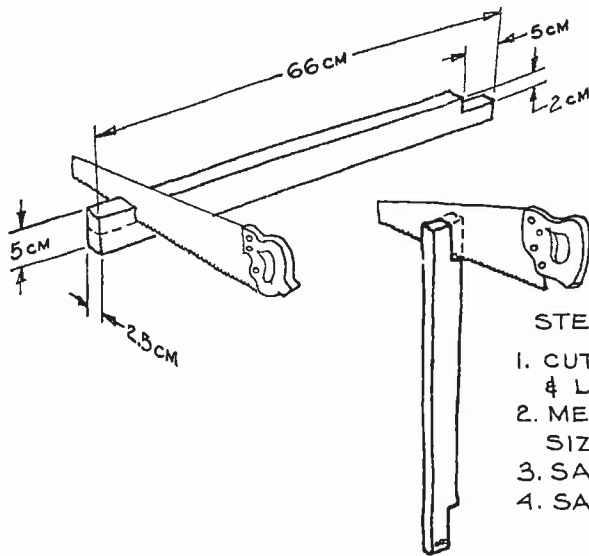

STEPS

1. CUT BOARD TO WIDTH & LENGTH.
2. MEASURE & MARK SIZE OF NOTCH.
3. SAW IN FROM SIDE.
4. SAW IN FROM END.

CUTTING DETAILS FOR DOOR FRAME SIDES

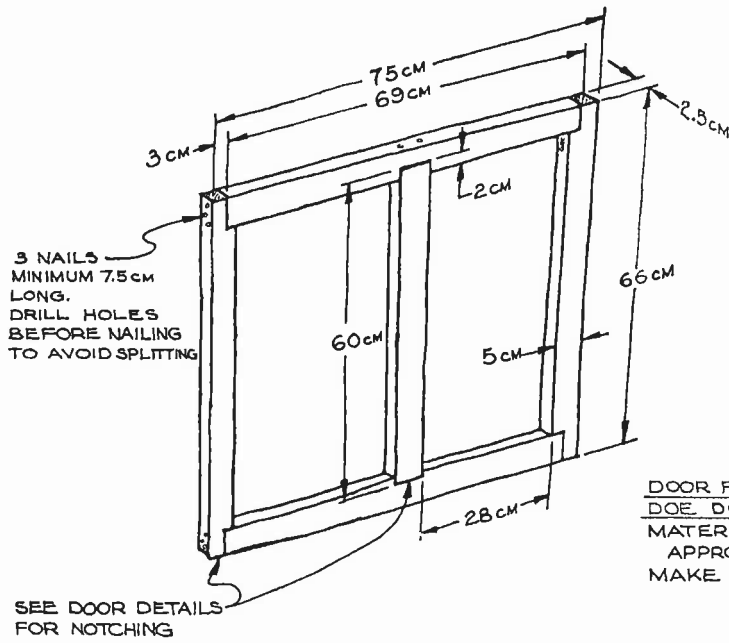

DOOR FRAMES  
DOE DOORS  
 MATERIAL:  
 APPROX. 2.5 X 5 CM  
 MAKE 2

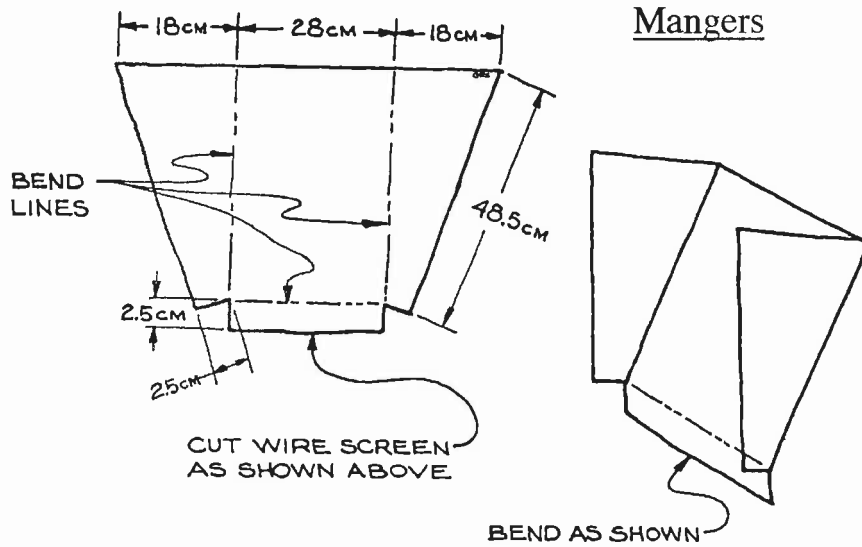
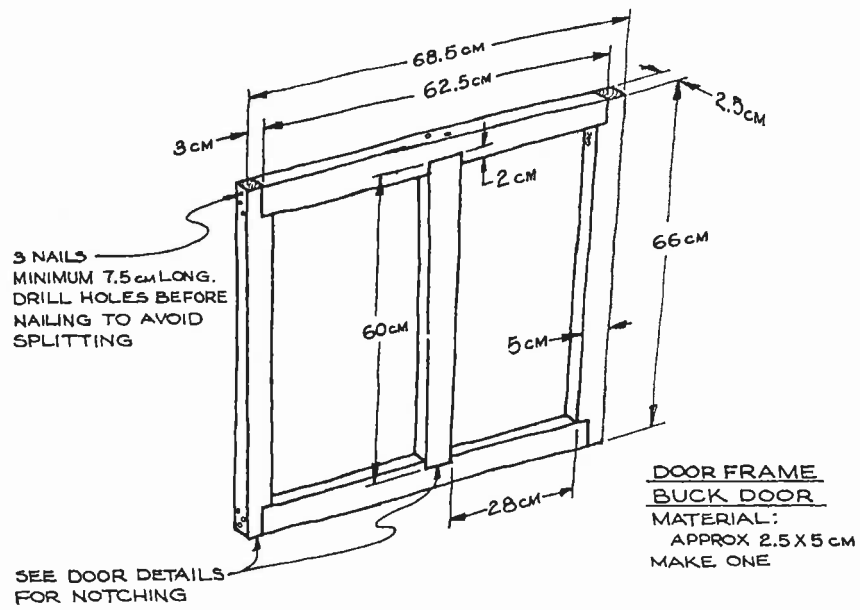

MANGER DETAILS

MATERIAL:

1.5cm SQUARE WIRE MESH SCREEN  
MAKE 3

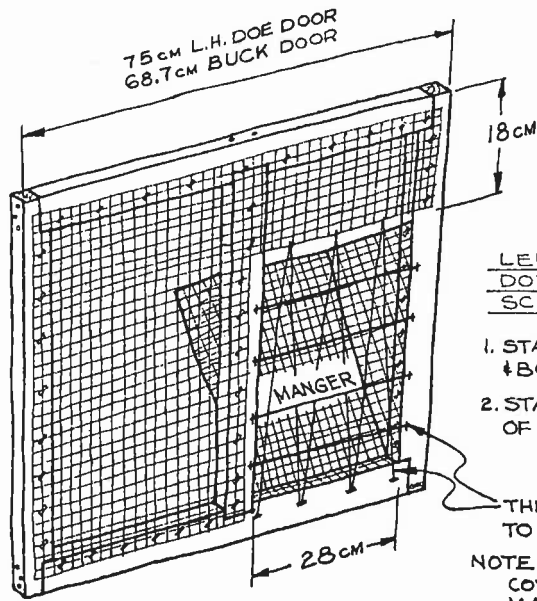

75 cm L.H. DOE DOOR  
68.7 cm BUCK DOOR

18 cm

28 cm

LEFT HAND  
DOE DOOR & BUCK DOOR  
SCREEN DETAILS

1. STAPLE MANGER TO INSIDE & BOTTOM OF FRAME OPENING.
2. STAPLE SCREEN OVER REST OF FRAME AS INDICATED.

THIN WIRE ACROSS OPENING TO MANGER

NOTE: MAKE A WIRE COVER FOR MANGER

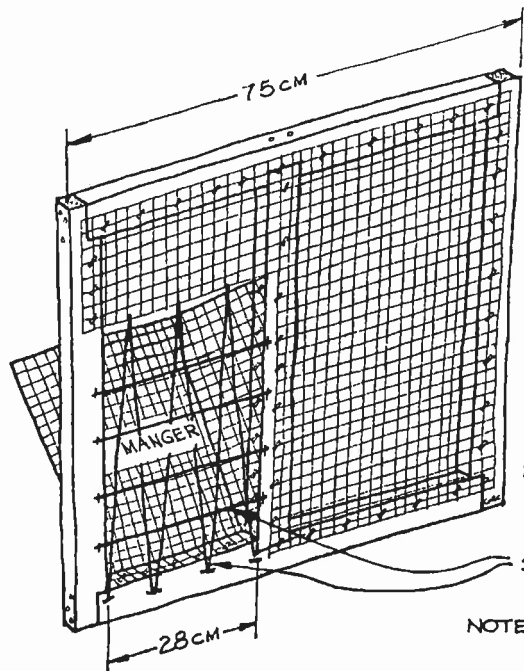

75 cm

28 cm

RIGHT HAND DOE DOOR  
SCREEN DETAILS

1. STAPLE MANGER TO INSIDE & BOTTOM OF FRAME OPENING.
2. STAPLE SCREEN OVER REST OF FRAME AS INDICATED.
3. THIN WIRE ACROSS MANGER OPENING.

NOTE: MAKE A WIRE COVER FOR MANGER

LEATHER STRAP &  
STAPLE

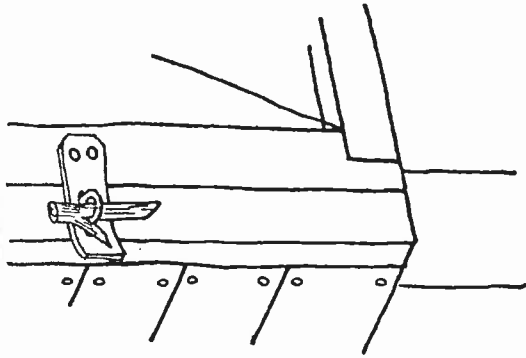

WOOD TOGGLE  
WOOD SCREW

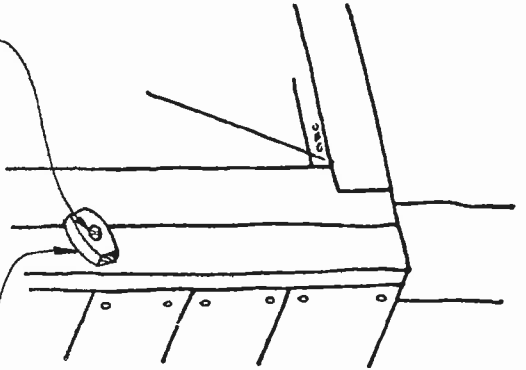

HOOK & EYE

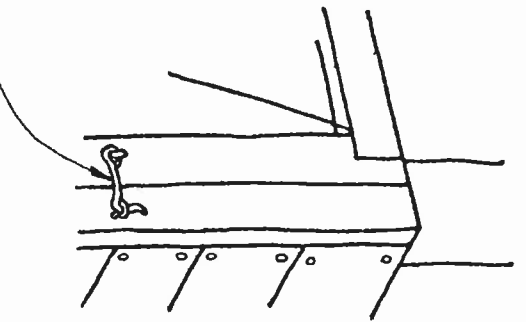

OPTIONAL DOOR LATCHES



## Wood And Bamboo Hutch

Assemble a wood frame.  
Attach a 1 x 1 cm (1/2 x 1/2 in)  
wire mesh floor.

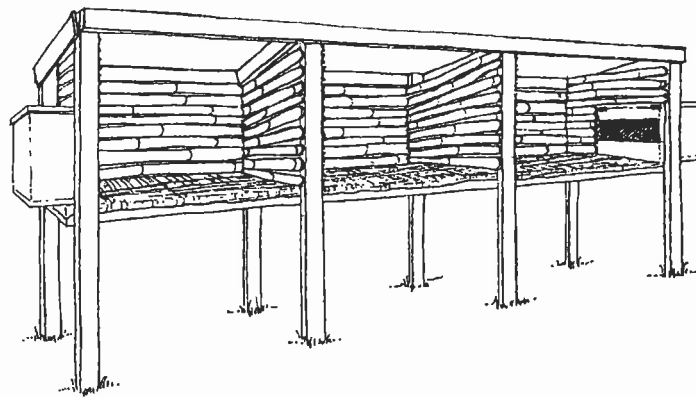
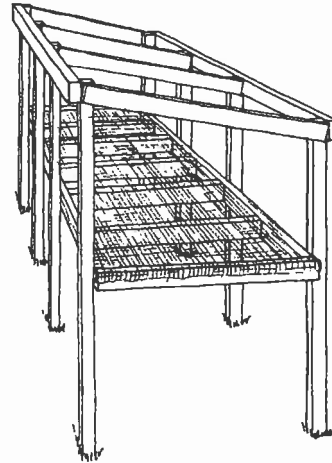

Nail full length strips of bamboo along the back wall.

Nail double walls of bamboo strips to form each divider between cages, and single walls of bamboo strips at each end of the hutch. Covering the interior walls with mud will help reduce the chewing of bamboo.

In this hutch, nest boxes made from wood crates have been built right into the outside wall of each of the end cages.

To make a roof, split bamboo lengths into halves, chip out the “nodes” with a hammer, paint the inside surfaces with a waterproofing substance like creosote or solignum, and nail down onto the top of the hutch frame in an interlocking pattern. Make the bamboo lengths long enough to overlap the front and back of the hutch.

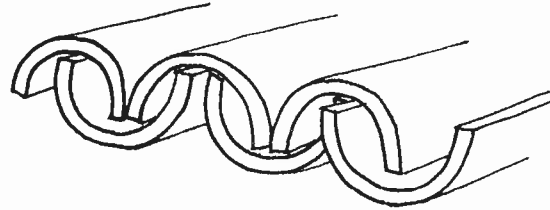

After nailing down the bottom pieces of the roof, you can either nail each top piece to the bottom ones, or lay all the top pieces into place without nailing, and hold them permanently in place by nailing every half meter or so through two or three half-sections of bamboo laid along the length of the hutch over the top pieces.

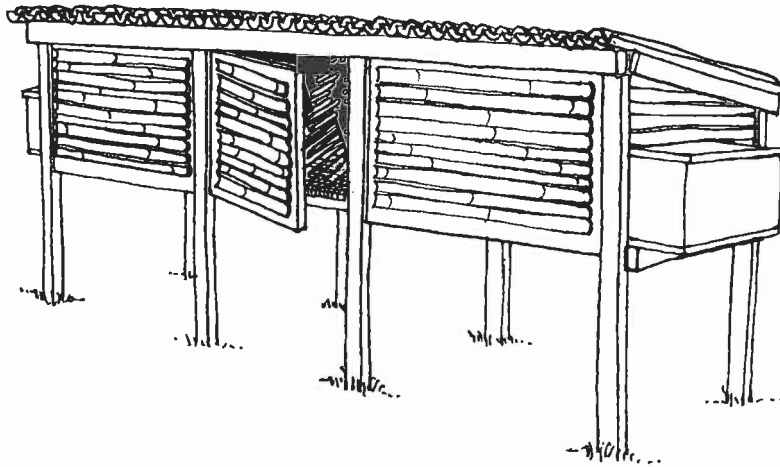

Frame a door to cover the entire front of each cage, and cover with bamboo strips nailed into each frame. Attach the doors to the hutch with two 4 inch hinges each and a latch for each.

## Commercial Feeds And Feeding In the USA

Careful observation and experimentation have greatly increased our knowledge of rabbit nutrition. Use the following recommendations as a guide. Observe your rabbits to see that they are growing at the rate you want and that breeding animals do not become over- or under-conditioned.

Tables 1 and 2 list recommended nutrient requirements for total digestible nutrients (TDN), crude protein (CP), and digestible protein (DP). Some requirements have been established for fat, vitamins, and minerals, but these are generally met by rations adequate in energy and protein. If allowed to, your rabbits will consume many different kinds of feed satisfactorily. Select feeds according to availability, cost, and quality.

**Table 1. Daily Nutrient Requirements of Rabbits.**  
(All feeds or rations are based on air-dry weights.)

Body Weight	Expected Daily Gain	Total Feed per Animal	Total Digestible Nutrients per Animal	Total Protein per Animal	Digestible Protein per Animal
pounds					
NORMAL GROWTH, DOES OR BUCKS. AVERAGE 6.5 POUND WEIGHT					
4 to 9	—	0.32	0.19	0.05	0.03
NORMAL GROWTH AND FATTENING, DOES OR BUCKS					
4		0.25	0.16	0.04	0.03
5	average	0.30	0.19	0.05	0.04
6	0.07	0.34	0.22	0.05	0.04
7		0.38	0.25	0.06	0.05
MAINTENANCE, DOES OR BUCKS					
5	—	0.20	0.11	0.03	0.02
10	—	0.33	0.18	0.04	0.03
15	—	0.45	0.25	0.05	0.04
PREGNANT DOES					
5	—	0.25	0.15	0.04	0.03
10	—	0.41	0.24	0.06	0.05
15	—	0.56	0.33	0.08	0.06

**Table 2. Nutrient Requirements of Rabbits in Percentages of Total Ration.**  
(All feeds or rations are based on air-dry weights.)

Body Weight	Expected Daily Gain	Total Daily Feed	Total Digestible Nutrients	Total Protein	Digestible Protein
pounds		percent			
NORMAL GROWTH, DOES OR BUCKS. AVERAGE 6.5 POUNDS					
4 to 9	—	5.8	60	15	11
NORMAL GROWTH AND FATTENING, DOES OR BUCKS					
4		6.2	65	16	12
5	average	6.0	65	16	12
6	0.07	5.7	65	16	12
7		5.4	65	16	12
MAINTENANCE, DOES OR BUCKS					
5	—	4.0	55	12	9
10	—	3.3	55	12	9
15	—	3.0	55	12	9
PREGNANT DOES					
5	—	5.0	58	15	11
10	—	4.1	58	15	11
15	—	3.7	58	15	11
LACTATING DOE AND LITTER OF 7					
5	—	—	70	17	13
10	—	—	70	17	13
15	—	—	70	17	13

High-energy concentrate feeds consist of whole grains, such as oats, barley, wheat, corn, milo, or by-products of grain processing, such as hominy, wheat bran, mill run, middlings, and shorts. These concentrates can be fed whole, coarsely ground, or pelleted. Be sure hard grains, such as flint corn or hard winter wheat, are cracked or ground to minimize waste.

Protein supplements include by-product meals of oil seeds, such as linseed, soybean, cottonseed, safflower, hempseed, and sesame. You can substitute any of these high protein supplements for each other on an equal protein unit basis in the diet. If you use cottonseed meal, be sure it is degossypolized as this substance is toxic to rabbits. Also, the amount of cottonseed meal should not exceed 5 to 7 percent of the ration, since there is some evidence that it may have a cumulative toxic effect. The above extracted meals are good feeds, but the original oil seeds, such as whole soybeans, are unpalatable. If original oil seeds are incorporated in the ration at

levels necessary to meet protein requirements, the rabbits may fail to consume the ration satisfactorily and go off feed.

For roughage, legume hays are preferred over grass hays mainly because they contain larger amounts of protein, calcium, and carotene (precursor of vitamin A). Alfalfa (lucerne) is usually the preferred roughage. Feed your rabbits roughages that are fine stemmed, leafy, of good green color, free of mold, and harvested at an early stage of maturity. If grass hays are fed, feed them in small amounts since their low protein and energy contents make it difficult to supply rabbits with adequate amounts of the required nutrients. Cut hay into 3 to 4 inch lengths to minimize waste.

To make sure that your rabbits get adequate salt, incorporate it into the ration or pellet at 0.5 percent or provide it free choice in a salt block or spool. If you are feeding locally grown feeds, find out if local livestock producers have had any problems with specific mineral deficiencies. If they have had problems, then you would probably want to use trace mineralized salt or a feed fortified in the lacking nutrient.

Most rabbit breeders use commercially prepared, pellet feeds. These feeds have several advantages. They are easy to store and feed and usually contain every nutritional element required for full feeding of pregnant and lactating does. Check the feed analysis tags to be sure they meet your rabbits' requirements.

An alternative to complete ration pellet feeding is to feed an all-grain pellet along with a high-quality roughage. An all-grain pellet usually consists of ground cereal grains, their milled by-products, protein supplement, and salt; while a complete pellet also incorporates a high-quality ground hay (at 40 to 60 percent of the pellet).

Rabbits should be feed pellets that are about 3/16 inch or less in diameter and 1/8 to 1/4 inch long. If the pellets are too long, then there will be considerable waste, especially with young rabbits

since they will have to bite off part of the pellet and may drop the rest of it on the ground.

If you wish to formulate your own rations and feed the ingredients separately or ground and mixed together, you can use the following method for calculating rations.

1. Pick a roughage and the proportion of the ration it will comprise. For example, if you use pre-bloom alfalfa for 40 percent of the ration, you can see from the nutrient analysis (Table 4) that alfalfa hay has 19.1 percent crude protein (CP) and 58 percent total digestible nutrients (TDN). Multiply these by 0.4 to get the following:

FEED	% OF RATION	CP	TDN
Alfalfa hay, pre-bloom	40	7.6	23

2. Add concentrates and repeat the process. For example, wheat and milo at 25 percent each give you:

FEED	% OF RATION	CP	TDN
Alfalfa hay, pre-bloom	40	7.6	23
Wheat grain, PCS	25	3.3	20
Sorghum, milo, grain	25	2.7	21
TOTAL	90	13.6	64

3. If you were formulating this ration for lactating does, you can see from Table 2 that it is low in protein and TDN. So, if you add 10 percent soybean meal, you get:

FEED	% OF RATION	CP	TDN
Alfalfa hay, pre-bloom.	40	7.6	23
Wheat grain, PCS	25	3.3	20
Sorghum, milo, grain	25	2.7	21
Soybean meal	10	4.6	8
TOTAL	100	18.2	72

**Table 3. Examples of Adequate Diets.**

Ingredients	% of Total Diet
<b>NORMAL GROWTH 4 to 9 POUNDS, AVERAGE 6.5 POUNDS</b>	
Alfalfa hay	60
Corn, grain	22
Barley, grain	15
Soybean meal	3
<b>NORMAL GROWTH AND FATTENING 4 POUNDS INITIAL WEIGHT; 8 POUNDS FINAL WEIGHT<sup>2</sup></b>	
Alfalfa hay	40
Wheat bran	5
Barley, grain	32
Oats, grain	18
Soybean meal	5
<b>MAINTENANCE, DOES AND BUCKS, AVERAGE 10 POUNDS WEIGHT</b>	
Alfalfa hay	70
Oats, grain	20
Wheat, grain	10
<b>PREGNANT DOES, AVERAGE 10 POUNDS WEIGHT</b>	
Clover hay	50
Oats, grain	44
Soybean meal	6
<b>LACTATING DOES, 10 POUNDS AVERAGE WEIGHT; LITTER OF 7</b>	
Alfalfa hay	40
Wheat, grain	25
Sorghum, grain	25
Soybean meal	10

From another look at Table 2, you can see that this ration will supply adequate protein and TDN for lactating does if fed in sufficient quantity. This ration is simple and could also be used to feed other classes of rabbits.

Table 3 presents additional rations that are satisfactory for various classes of rabbits. These rations also are suitable for pellets. This example of ration calculation illustrates the fact that you do not need complicated rations to supply adequate nutrients to your rabbits.

You can feed rabbits either by hand or by means of a feed hopper from which the rabbits may eat at will. Full feeding is satisfactory for pregnant does, does nursing litters, and rabbits being fattened for market. In addition to rapid growth, full feeding usually increases the efficiency of weight gains. Restricted feeding (usually done by hand feeding) is recommended for herd bucks, dry does, and young breeding stock to prevent them from becoming too fat. It is important that herd bucks, dry does, and young breeding stock be kept in good physical condition and not allowed to become too fat. It is also important to make sure that all your rabbits have plenty of clean, fresh water at all times.

**Table 4. Partial Composition of Feeds Commonly Included in Rabbit Diets.**  
(All data are on an as-fed basis.)

	DM	TDN	DE	CP	Ca	P	Carotene
	percent		Kcal/lb		percent		mg/lb
<b>CONCENTRATES</b>							
Barley grain	89	70	1450	11.7	0.08	0.42	0.18
Beet pulp, dried	91	70	1374	9.1	0.68	0.10	0.1
Bread, dried	96	100	1900	15.8	—	—	—
Brewers grain, dried	92	58	1342	25.9	0.27	0.50	—
Corn dent #2	89	82	1661	8.9	0.02	0.31	0.8
Cottonseed meal, solvent	91	66	1320	41.6	0.15	1.10	—
Linseed meal, expeller	91	70	1400	35.3	0.44	0.89	0.14
Milk, cows, whole	12	25	298	3.1	—	—	—
Milk, dehydrated	94	117	—	35.2	0.89	0.68	3.2
Oats, grain	89	65	1320	11.8	0.10	0.35	0.0
Sorghum, milo, grain	89	84	1680	11.0	—	—	—
Soybean meal, solvent	89	82	1640	45.8	0.32	0.67	0.1
Wheat grain, PCS	89	79	1595	13.0	—	—	—
Wheat bran	89	57	1193	16.0	0.14	1.17	—
<b>ROUGHAGES</b>							
Alfalfa hay, pre-bloom	89	58	1160	19.1	1.89	0.27	202.3
Alfalfa hay, early bloom	90	40	853	16.6	1.12	0.21	51.9
Clover, red, hay	88	43	874	13.1	1.42	0.19	15.0
Lespedeza, hay	90	39	837	14.8	—	—	—
Oat hay, early bloom	93	26	500	4.3	0.23	0.21	40.4
Soybean hay	89	45	683	14.5	1.15	0.20	14.4
Sudangrass hay	89	43	920	11.3	0.50	0.28	—
Vetch, common hay	86	46	945	17.6	1.20	0.30	183.0
<b>GREEN ROUGHAGES, ROOTS AND TUBERS</b>							
Cabbage, aerial	8	8.0	155	1.7	—	—	—
Carrots, roots	12	10.8	198	1.2	0.05	0.04	—
Rutabaga, roots	13	10.0	230	1.3	—	—	—
Potatoes, sweet, tubers	42	28.0	709	1.8	—	—	—
Turnips, roots	9	7.4	140	1.2	0.06	0.02	—

Source: *Rabbit Handbook*, University of California, Division of Agriculture and Natural Resources, Oakland, California, USA.



## Preparing For Exhibits And Shows

Agricultural youth clubs are popular in many countries throughout the world. Although they are called by different names— 4-H, Young Farmers, Future Farmers, etc.— they all share similar goals: to help youth develop into responsible, self-directed, productive citizens of the world, and to improve the well-being of youth and society through the use of learn-by-doing educational experiences.

Raising small animals— particularly rabbits— has always been a popular project activity. In addition to the rewards gained by raising rabbits for food, many people find pleasure in showing their best animals in shows and contests. Shows can also be used to recognize farmers who keep good records and achieve outstanding herd performance. Rabbit raising can be popularized through shows at the grass-roots level. Sometimes shows are combined with slaughter-skinning demonstrations and cooking contests. The following discussion (adapted from *Rabbit Handbook*, University of California, Division of Agriculture and Natural Resources, Oakland, California USA) presents some guidelines for showing rabbits and a glossary of terms often used by judges at competitions. The information should be modified to suit local needs.

Begin preparing rabbits for an exhibit or show several months before the event. Carefully select each rabbit from the best stock you have. Winning animals are the result of careful selection and long hours of care and attention— not just a few minutes of frantic effort.

Raise exhibit or show animals in clean, dry housing. If there are more than six animals in a litter, remove those that are small or weak and allow for maximum growth of the rest.

Feed rabbits a good quality ration on a regular schedule. Give the animals limited amounts of such supplementary feeds as hay or a seed that contains some fat or oil (such as sunflower seed or flax seed).

Periodically weigh each animal to check its rate of gain. If you need to slow the rate of gain, add a roughage material, such as a tablespoon of rolled oats, to the ration. Feed animals for condition, coat, and maximum class size and weight. Remember: extra fat on animals often causes the animal to shed. Have your animal in top condition, but not fat.

Regularly handle animals. Use a table or other flat area where you can pose and train animals. Cover the area with burlap or a piece of carpeting. Take animals from the cage, patiently train them to pose, gently pet them, and finally get them used to being handled as they will be when being judged or shown. Practice posing the animal in the position you expect to use for showing it. Do not allow the rabbit to stretch out or run around when you want it to pose. Start training early and continue working with each rabbit until exhibit or show time.

If you plan to exhibit does as pregnant, breed them so that they are at least 9 to 10 days from kindling on the day they are to leave the show.

To partly eliminate minor hutch stains, generously apply white vinegar to the stained areas. After applying the vinegar, sprinkle baby powder through the fur if the rabbits are white. Carefully examine each animal for last-minute disqualifications.

Condition the coat as much as needed. Lightly moisten your hands with water, then gently rub the fur (both the right and wrong way) to remove all loose hair. Wipe your hands often to remove the sticking hair. *Be sure to gently wipe the animal dry.* If necessary, repeat this process until the coat is free of loose fur. Never groom

your animal with a comb or brush since it may cause breaks in the hair or the skin. A lightly moistened chamois cloth is excellent for removing loose hair and gives the coat a sheen. Angora rabbits will require grooming with a comb or brush to remove mats from the wool. Clean the carrying cases and add fresh bedding. Keep your animals in the carrying cases for as short a time as possible. If the weather is warm, try to move your animals at night.

At the exhibit or show, coop your animals if that is allowed. Check on them regularly during the event.

When the animals are judged, be present to hear the judges' comments. If possible, get a copy of the comments.

When you take your animals home, handle them just as carefully as you did when taking them to the exhibit or show.

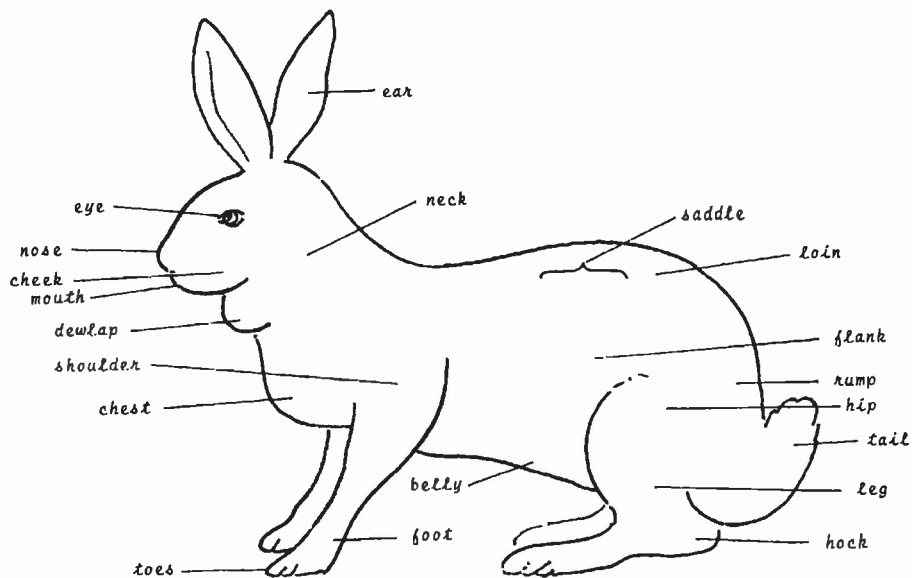

# **Glossary**

## **Agouti**

A specific fur color due to the fact that each hair shaft has three or more bands of color with a definite break in between the color bands. The hair is usually dark slate at the base, with two or more alternating light and dark bands or rings interspersed with black guard hairs.

## **Breed**

A race or special class of domestic rabbits that reproduces distinctive characteristics of fur markings and texture as well as animal shape, size, and growth. (See the following chart.)

## **Breeding Certificate**

A written certificate for a buck that shows its full pedigree and the date of breeding. The certificate establishes proof of ancestry for the off-spring.

## **Broken Coat**

A coat affected by molt; an undercoat that is exposed due to broken or missing guard hairs.

## **Chopped**

The back and loin of the body cut off sharply and the back is not gracefully arched.

## **Cobby**

The body is stout, stocky, short legged, and short coupled.

## Standard Rabbit Breeds And Varieties Raised In Many Parts Of The World

Source: *Rabbit Handbook*, University of California, Division of Agriculture and Natural Resources, Oakland, California, USA.

Breed	Variety	Pounds		Utility Value	
		Ideal Mature buck	Weight doe	meat	fur
Alaska	Black	7½	7	fair	fair
American	Blue, White	9	10	good	good
Angora, English	Black, Blue, Fawn, White	6	7	good	good
Angora, French	Black, Blue, Fawn, White	8	8	fair	fair
Belgian Hare	Black, Blue, White	8	8	fair	fair
Beveren	Black, Blue, White	9	10	good	good
Californian		9	9	very good	very good
Cinnamon		9	10	good	fair
Champagne D' Argent		10	10½	good	good
Creme D' Argent		9	10	good	good
Checkeder Giant	Black, Blue	11+	12+	good	fair
Chinchilla, American		10	11	good	good
Chinchilla, Giant		13 to 14	14 to 15	good	good
Chinchilla, Standard		6½	7	good	good
Dutch	Black, Blue, Chocolate, Gray, Steel Gray, Tortoise	4½	4½	small	fair
English Spot	Black, Blue, Chocolate, Gold, Gray, Lilac, Tortoise	6	7	small	fair
Flemish Giant	Black, Blue, Fawn, Light Gray, Sandy, Steel Gray, White	14+	15+	good	good

Florida White				5					good
Harlequin				7					good
Havana		Harlequin, Maggie Chocolate, Blue		6	5				good
Himalayan				3 <sup>1</sup> / <sub>2</sub>					fair
Lilac				6 to 7	6 <sup>1</sup> / <sub>2</sub> to 7 <sup>1</sup> / <sub>2</sub>				fair
Lop, English		Broken, Solid		10	11				fair
Lop, French		Broken, Solid		10	11				fair
Netherland Dwarf		Agouti, Patterned, Selfs, Shaded, Tan, Any Other Variety		2	2				fair
New Zealand		Black, Red, White		10	11				very good
Palomino		Golden, Lynx		9	10				good
Polish		Black, Chocolate, Blue-eyed White, Ruby-eyed White		2 <sup>1</sup> / <sub>2</sub>	2 <sup>1</sup> / <sub>2</sub>				fair
Rex		Black, Blue, California, Castor, Chinchilla, Chocolate, Lilac, Lynx, Opal, Red, Sable, Seal, White		8	9				good
Rhineland				8 <sup>1</sup> / <sub>2</sub>	9				fair
Sable				8	9				fair
Sable, Siamese				5 to 7	5 to 7				fair
Satin									
Silver		Black, Blue, Californian, Chinchilla, Chocolate, Copper, Red, Siamese, White		9 <sup>1</sup> / <sub>2</sub>	10				good
Silver Fox		Brown, Fawn, Gray		6	6				fair
Silver Marten		Black, Blue		10 <sup>1</sup> / <sub>2</sub>	10 <sup>1</sup> / <sub>2</sub>				good
Tan		Black, Blue, Chocolate, Sable		7 <sup>1</sup> / <sub>2</sub>	8 <sup>1</sup> / <sub>2</sub>				good
Vienna Blue		Black, Blue, Chocolate, Lilac		4 to 5 9 to 10	4 <sup>1</sup> / <sub>2</sub> to 5 <sup>1</sup> / <sub>2</sub> 10 to 11				good good

## **Condition**

The physical state of a rabbit, including health, cleanliness, texture and molt of fur, and general grooming.

## **Cow Hocks**

The hock turns or bends inward, causing the foot portion to turn outward.

## **Density**

A thick coat due to the compact growth of the fur.

## **Disqualification**

One or more permanent defects, deformities, or blemishes that make the animal unfit to win an award in competition and ineligible for registration.

## **Ear-Lacing**

A black or dark-colored line of fur that outlines the sides and tip of the ear.

## **Elimination**

One or more defects, presumed to be temporary and curable, that eliminates the animal from consideration for an award.

## **Eye Color**

The color of the iris, the circle of color surrounding the pupil.

### **Fine Coat**

The hair is very thin and lacks body. The guard hairs are usually very weak.

### **Flabby**

The flesh or fur hangs loosely on the animal, showing a lack of trimness and shape.

### **Flat Coat**

The fur lies flat, or close to the body, and lacks spring.

### **Fly Back**

Fur that, when stroked from the rear towards the head, quickly returns to its normal position.

### **Glossy**

The natural sheen of the fur enhanced by correct grooming.

### **Guard Hair**

The longer, coarser hair of the coat that protects the undercoat and provides sheen.

### **Hindquarters**

That part of the body composed of the loin, hips, hind legs, and rump.

### **Inner Ear**

The concave portion of the ear.



## **Intermediate**

A heavyweight rabbit that is at least 6 months old but less than 8 months old.

## **Junior**

A rabbit that is less than 6 months of age.

## **Kindle**

To give birth to rabbits.

## **Open Coat**

Fur that lacks density in the undercoat and usually has fine guard hairs and poor texture.

## **Lopped Ear**

A pendulous ear that is not carried erect and falls to the side or front.

## **Luster**

The brightness and brilliance of the fur.

## **Mandolin**

The back and saddle of the body arch toward the loins to make a noticeable large and broad hindquarters.

## **Marked**

The rabbit's basic color is broken up by an orderly placement of colored fur, usually on a white background.

**Massive**

The body is bulky, heavy, and usually large and compact.

**Meaty**

An animal that carries a goodly proportion of meat in comparison to its size and type; refers mainly to the forequarters and the hindquarters.

**Molt**

The process of shedding or changing the fur.

**Paunch**

The prominent portion of the abdomen.

**Pedigree**

A written chart of the male and female ancestors of a rabbit. A pedigree gives the date of birth, breed, variety, weaning weight, and past ownership of dams and sires for three generations.

**Pelage**

The fur coat or covering of an animal.

**Pot Belly**

A distended condition of the stomach and intestines.

**Poor Coat**

Fur that is molting, rusty, or rough due to poor health of the rabbit.

## **Racy**

An animal that has a hare-like body and legs and is slim, trim, alert, and active.

## **Rust**

A discoloration of the fur, usually on the sides, flanks, or feet. Rust may be caused by fading through overexposure to sunlight, dirty hutches, or dead hairs about to molt.

## **Self-Color or Self-Colored**

Animals that have the same color fur over the entire head, legs, body, and tail.

## **Senior**

If there are two show classes for a breed, it is a rabbit that is 6 months old or older. If there are three show classes for a breed, it is an animal that is older than 8 months.

## **Shadow Bars**

Weakness of self-color in the fur of both fore and hind feet; appears in the form of white or lighter colored bars running across the feet.

## **Spraddled**

If it refers to the front feet, it means they are bowed outwardly when viewed from the front. If it refers to the hind feet, it means the legs are not set parallel with the body, but turned outward from the hock joint.

## **Strain**

A race or stock of rabbits in any standard breed of the same family blood and having the quality of reproducing racial characteristics.

## **Tail Carriage**

The way a rabbit carries its tail.

## **Texture**

The quality of the fur, as determined by feel or touch, when stroked toward the head.

## **Ticking**

A wavy distribution throughout the fur of longer guard hairs distinct in color from the underwool or body fur. The ticking is usually produced by black-or white-tipped guard hairs and adds to the beauty of the rabbit.

## **Type**

The general description of the physical make-up of the animal; the body conformation of a rabbit or the shape of a particular part of an animal.

## **Undercoat**

The base of the fur hair, the shaft next to the skin; not the belly fur of the animal.

## **Variety**

A subdivision of a breed usually based on minor but distinctive characteristics, such as color.

### **Wall Eyes or Moon Eyes**

A cornea that has a milky film over it; colored eyes that have extremely light irises and a glazed appearance.

### **Wool**

The fur of Angora rabbits; the guard hairs and underfur are 2 1/2 to 5 inches in length and resemble fine wool in texture.

### **Wry Tail**

A tail that is abnormally and permanently bent, curled, or twisted to one side; a corkscrew tail with one or more turns.

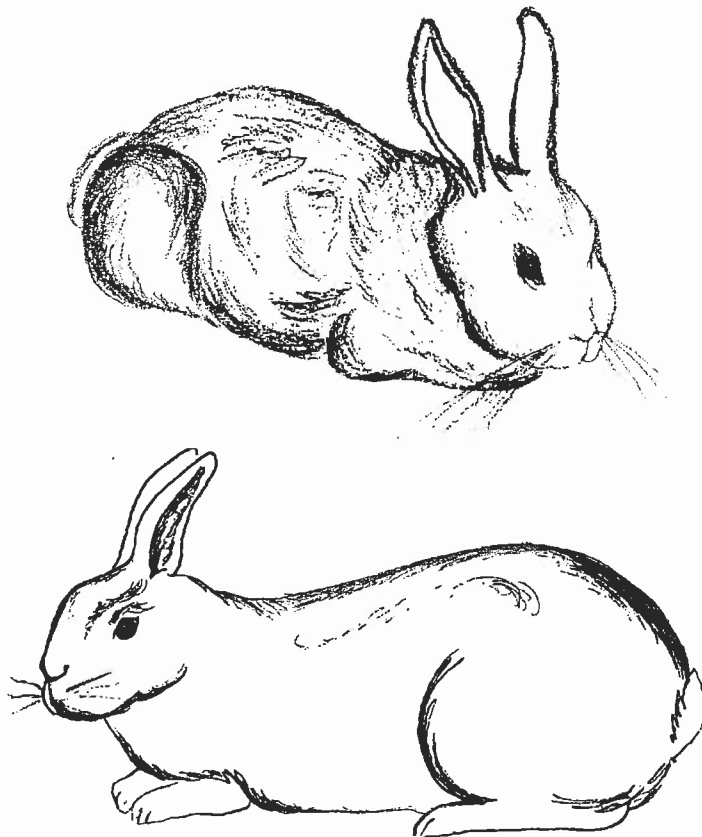

## Worm Husbandry

Turn your rabbit manure accumulation into a home for one of the farmer's greatest friends—the earthworm.

Growing worms is easy and the advantages are many. Rabbit manure and waste feed falling through the wire make good food for earthworms.

Dig pits or place shallow bins below the hutch floors, and stock them with worms. The worms will consume and compost the pellets, creating finely ground fertilizer of the very highest quality.

Bins or shallow pits can be formed from cement, cinder blocks, or lumber 2" x 12" (5 x 30cm) and are sunk a few inches (or centimeters) into the ground. Since worms breed best at temperatures above 4.5°C (40°F), pits should be sunk low enough to ensure against soil temperatures colder than this during the fall. During the winter the worms will slow down or become dormant. The colony will quickly re-activate during the spring when the soil temperature rises.

Bins or pits should be a few centimeters or inches larger than the actual size of the hutch so they will catch every pellet.

“Pit-run” worms are economical to start with and are obtainable from earthworm growers and many rabbit raisers. To start a “worm farm” lay down a starter mix of 50 percent rabbit manure and 50 percent peat moss or fine compost. If moles are a problem, 1 cm (1/2") square wire mesh can be used to line the bottom and sides of the pit. A few inches of crushed limestone can be placed at the

bottom of the pit to correct manure acidity and provide a porous base for drainage.

Keep the pits moist by sprinkling them with a little water. Some rabbit and worm growers make a habit of emptying the water crocks directly into the worm bins when refreshing the rabbits' water supply. The only other work involved is levelling the pits as the compost "grows" and forking over the bin contents every 2 or 3 weeks to keep it loose.

When the bins get too full of worms some of them should be forked out (a shovel will cut the worms), and deposited in the garden, flower beds, or greenhouse, or they can be sold.

Books packed with information on earthworm husbandry are available from, Shields Publications, P.O. Box 669, Eagle River, Wisconsin 54521 USA.



## Raising Guinea Pigs (Cavies)

Actually this animal is not a pig and it doesn't come from Guinea; it is a rodent from South America, first tamed by the Incas of Peru. Guinea pigs were a major meat source for Andean Indians long before the arrival of the Spaniards in the 1500s. It is thought that some of these animals were taken by English and Dutch slave traders to Guinea and then on to Europe which may explain the name *guinea pig*. The only similarity with the pig is a low grunt made by the animal when it is hungry. The guinea pig is more correctly called a cavy (pronounced K-V). Cavies are raised for food throughout many parts of Africa, Asia, and South America. It is estimated that 70 million cavies are consumed in Peru alone.

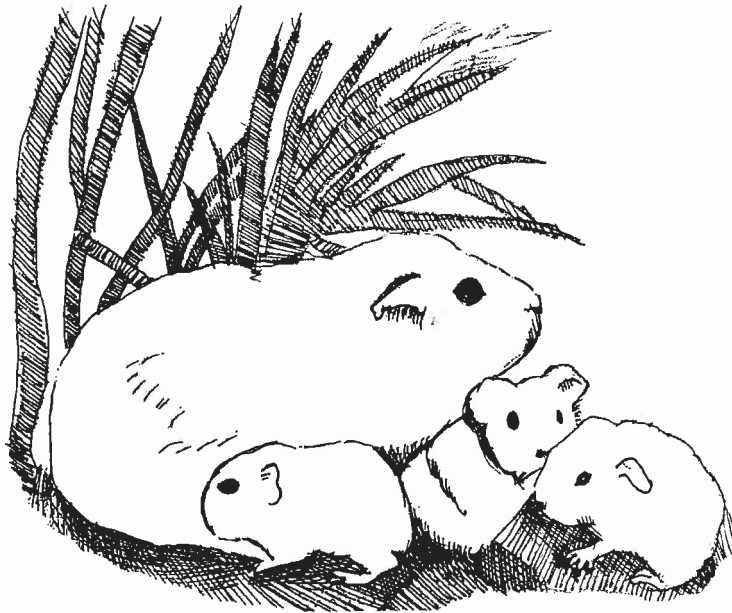

Most mature cavies weigh less than a pound (.45 kg) although there are some improved types that can weight between 1.5 and



2.0 kilograms. Unlike larger animals, such as pigs and goats, the cavy can be consumed in a single meal thus eliminating the need for refrigeration. Cavy meat is dark, very flavorful, and low in fat. It has a protein content of about 21%, which is higher than the protein content of pork, mutton or beef.

In some countries, the skin is not an important by-product because it is often eaten along with the other edible parts. However, the fur of cavies *can* be cured and the pelts made into garments, handbags, house slippers, or braided into ropes.

Cavy manure contains nitrogen and phosphorus making it a welcome addition to the home garden. It is also high in protein—about 18 percent. On some farms this “naturally pelleted” manure is used as a feed ingredient for other livestock.

Cavies are gentle, prolific, and easy to care for, and when fed kitchen scraps and legumes, are efficient meat producers. Twenty females and two males can provide adequate meat year-round for a family of six.

Unlike rabbits, cavies can be noisy. They squeal when hungry or frightened, and murmur as they eat. However, some people enjoy these sounds. Cavies enjoy colony life (living with others) and often seek out dark places where they can hide.

The cavy comes in a wide variety of sizes and colors. They adapt themselves very well to different environments but do not thrive under cold conditions for prolonged periods of time. There is one type of cavy that lives in the desert plains and one that lives in water. Coat type (short-haired, long-haired, rough-haired) and color are often used to distinguish varieties of cavies. Among the breeds are Abyssinian (short, wiry hair in rosettes), the American (short, silky hair), the Peruvian (dense, silky, long hair), the Satin (hollow hairs giving a sheen), and the Silkie (long silky hair). Another cavy—the *Macabeo*— is large in size and often used for

meat production. Because the long-hair breeds require special care and grooming they should be avoided by the novice.

## Selecting

It is best to start with animals that are six to eight weeks old after they have been weaned from their mother. Young animals easily adapt to new homes and will settle down quickly. Choose animals that have large brilliant eyes, broad shoulders, sound teeth and a good coat. The animal should be active and full of spirit. When given proper care and feeding, the life span of a cavy is about 6–8 years, although many cavy raisers replace their breeders every 18–24 months.



## Handling

Cavies are very timid animals by nature and do not bite, although they can scratch when frightened. Because of their gentle nature, young children often enjoy participating in cavy raising projects. When picking up a cavy, you must take care not to lift it by the shoulders or the top of its body. You should support its weight with your hand or it could

twist suddenly and injure its internal organs. Also, it should not be dropped as it will usually land on its head and probably die.

Lift the cavy by sliding your hand under its belly, palm up, with its chest and front legs resting on your wrist and your other hand supporting and steadying it. Babies should be handled as soon as possible to make them tame and even tempered.

## Feeding

Cavies enjoy a broad range of grasses, legumes, weeds and herbs. These plants are also an important source of vitamin C— a vitamin that is essential to its life and one that it cannot manufacture on its own. Cavies can be fed similar to rabbits, although cavies enjoy more dried grasses and legumes. These hays help the animal to digest what has been eaten. Without it a cavy will often chew its own hair and not grow properly. In addition to hays, cavies can be fed fruits, vegetables (tops, roots, parings), rabbit pellets, poultry mash, grains, and bread. In Peru, they are usually reared on the kitchen floor of the home and fed kitchen scraps, wild grasses, barley, and alfalfa (lucerne).

Cavies generally do not like strong smelling foliage or foliage known to be high in oxalic acid. Leaves known to be poisonous to people should not be used. Cavies prefer soft, tender foliage and cannot utilize woody parts. The foliage of many trees can be fed to cavies but they may reject the tough, older leaves.

Too much succulent food (containing lots of moisture) can lead to bloating and even death. Partial wilting of the greens before feeding can reduce this problem. This is easily accomplished by placing the plant material on a simple drying rack for a few hours before feeding time. Many breeders feed their animals the main meal at night, when cavies eat most of their food. The foliage should be kept off the floor—either tied and suspended or placed in a manger—to prevent the animals from fouling it with urine and feces (their droppings). Water should be provided and is particularly important in hot weather when the female is pregnant or nursing young.

## Housing

Cavies require very little space. Ten females and one male can be housed comfortably in a cage or pen measuring 1 by 1.20 meters (39" by 47"). In many parts of Latin America above-ground pens



are more commonly used for cavy rearing than cages. The amount of floor space needed for each cavy depends upon its size. The minimum floor space is approximately .75 square feet (700 sq. cm). Because cavies do not climb the depth of their cages can be from 14 to 22 inches (36–55 cm). In Peru, cavies are traditionally raised by women and children in the farm home.

In many parts of West Africa, they are confined to one part of the “country kitchen” or bedroom of a family compound. They can also be housed in hutches with self-cleaning floors made of 1/2 x 1/2 inch (1 centimeter square) hardware cloth, bamboo, or other natural materials (see Chapter 2). When using wire floors provide small wood platforms or a small, removable open box (no top or bottom) turned on its side, so the animals can sleep on a solid

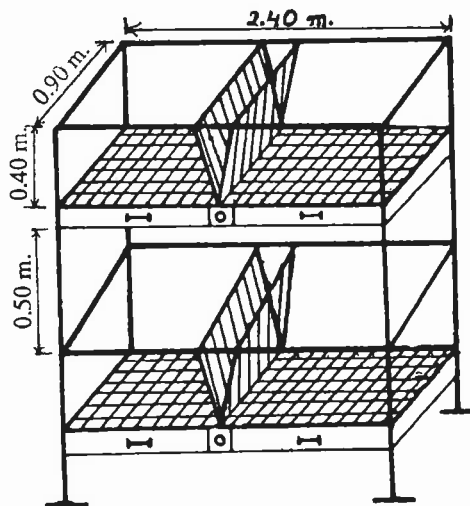

surface. The later provides *two* resting areas; females and young will often seek shelter within the box while larger animals will sleep on the upper surface.

Left, is an example of a cage used by people who have access to manufactured wire products. In some countries, where wood is costly, all wire cages maybe inexpensive to build. This two-tier cage provides

mangers for hay and forage material. The sides can be of wire, or a solid material if more insulation is needed—when placed outdoors, a simple roof with a good overhang will be required. Slide-out drawers, layered with some sort of absorbent material (sawdust, hay, etc.), are often used to collect the manure and urine. To eliminate the cost and manufacture of drawers, a wood or metal sub-floor can be installed just a few inches below the wire floor and slanted to the rear of the cages. This allows the manure and urine to roll off and collect on the floor behind the cages. Some cavy raisers place leftover forage and hay at the “drop-zone” to soak up the urine. To prevent flies from breeding the “pre-composted” material is removed every few days and added to the compost pile.

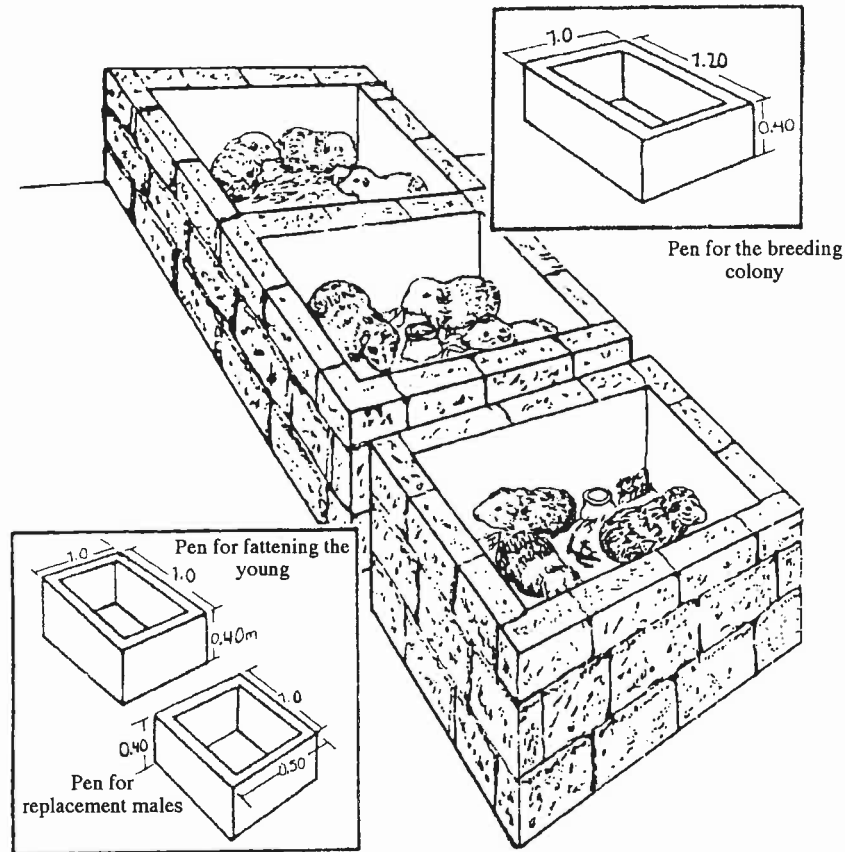

In many parts of Latin America, cavies are housed in pens like the ones shown, left. Only a small area is needed such as the corner of a room. A wide variety of materials can be used for building pens. Solid walled pens can be constructed of wood, stones, mud and cement bricks, with a mud or cement plastering.

The pens are of three sizes. The largest is for the breeding male (sire) and his female mates (dams); the second largest is used to hold (and fatten) recently weaned young; and the smallest is for a replacement male or two. Many breeders recommend *two* holding pens—one for males and one for females. The floors of the pens can be covered with sawdust, leaves, hay, etc. The recommended number of animals for this system is one male for every 7–10 females. With proper care and feeding it is possible to obtain approximately 100 offspring a year.

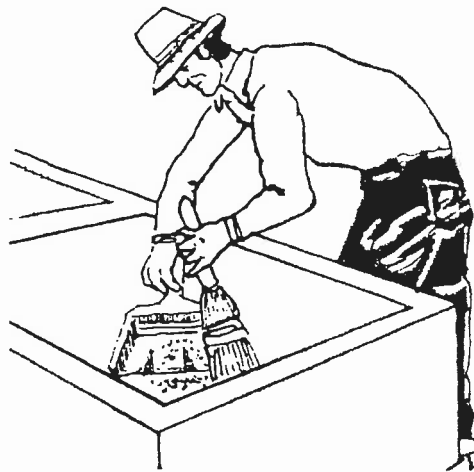

Those interested in raising cavies on a larger scale can build a small shed to hold more breeding pens with their respective smaller pens.

Good sanitation is a must when this system of housing is used. The pens must be kept clean and dry. The droppings should be swept out and the bedding changed every 15 days. Rats and other animals must be kept out of the boxes or areas where food is stored.

Whatever type of housing you provide, make sure it is a dry place, protected from drafts, with good air circulation.

## Mating

Females begin breeding at two to three months of age and produce up to five litters a year. Males are used for breeding at about four months of age. However, there are times when cavies may take many months before they decide to mate. Sterility among females can be a problem, especially with age. Many cavy raisers routinely replace their breeders every 18–24 months.

Cavies prefer colony life and a male with several females seems very content. Five to ten females can live with one male, but never put two males together where there are females present or

they will fight and injure themselves. Animals being kept for fattening should be separated at weaning according to sex to prevent fighting and inbreeding.

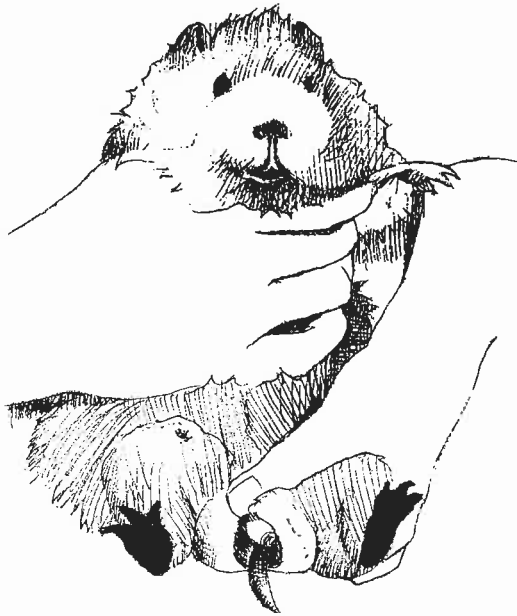

The sex of an animal of breeding age becomes obvious if you press on the lower abdomen (stomach); with males the penis will quickly protrude, left. Some breeders identify males by watching for mounting behavior and signs aggression.

The gestation period (time from mating until birth) is about 70 days, although there are some varieties that take 65–75 days. Litters consist of 1–6, with three being the average. Litters of just two are common in the absence of good feeds and management. The babies are born with their eyes open and their bodies

covered in soft fur. They are able to eat solid food almost immediately after birth. The young can be weaned when they are three to four weeks old, although some cavy breeders remove the young when they are only two weeks old. When raised under good conditions the dam can bear young five times a year. However, four matings a year is recommended to reduce breeding stress. Two problems can result when cavies are kept in colonies:

**Inbreeding**—Brother–sister or parent–offspring matings can result in unhealthy, unproductive animals. One practical measure to eliminate this problem is to remove the young from their parents before they are of breeding age, and place them in separate pens. Another line of defense is to trade breeding males from unrelated colonies, with other cavy raisers every six months.

**Post-partum matings**—It is very hard on a breeding female if a male mates with her just after she gives birth because she has little time to rest between litters. Fortunately, many of the non-fancy breeds used in developing countries are hardy and can handle a demanding mating schedule when well-fed and managed properly. However, to maintain maximum production throughout the year it is recommended that breeding females be replaced after producing six litters.

There have been several attempts to improve the production of meat from cavies. One Peruvian breeding program reported average weights had increased from .7 to 2.0 kilograms, due to its accelerated growth rate. Check with your local agriculture office or university extension program to see if improved cavy breeds are available in your area.

## **Ailments**

The cavy is a hardy animal and when properly fed and cared for it experiences very few health problems. Good management practices include the regular sweeping of manure and feed wastes,



and adding these materials to the compost pile for later use in the home garden.

There are usually fewer disease problems and less deaths with cavies than with rabbits. Major causes of death include stillbirth, trampling, predation, disease, and general neglect. Sick animals are often listless (not active), huddle in a corner, refuse to eat, and lose weight. Common ailments affecting them are lice, mange and ear mites, diarrhea (often caused by too many green vegetables fed too often), colds (caused by dampness and drafts), sore eyes, cuts, and abscesses (see Chapter 6). Also, if cavies consume an abundance of rich feeds (concentrates or mash) they may die due to “overeating disease.” Special precaution must be taken to provide safe shelters to protect the animals from cats, dogs, rats and snakes.

## **Killing And Skinning A Cavy**

Cavies can be killed by three methods: a strong blow to the back of the neck; by twisting and dislocating the neck; and by placing a thumb on the neck just behind the ears and quickly pressing down while pulling the cavy upwards (see Chapter 7).

Virtually the whole animal is edible. In some countries, the skin, head, soft bones, lungs, liver, and intestines are all relished.

Once killed, cavies are usually prepared by three methods. In the first, the hair is softened by putting the cavy in a container of hot but not boiling water, followed by scraping. The abdomen (belly) is then opened and the animal is cleaned. In the second method, after the animal is killed it is hung by a hind leg and the throat is cut to drain the blood. The skin of the abdomen is then pulled forward and slit with a knife or scissors. The cavy is then skinned. The third method is popular in many African countries— the animals are simply gutted and roasted over a low burning fire. The singed hairs are scraped off the skin with a dull knife.

In addition to the roasting method, the cleaned animal can be cut into pieces and fried, or boiled whole in a broth. In some countries, maximum use is made of the meat by cutting it into several large pieces and boiling it until soft. The meat is then shredded and the small bones are removed. Finally the meat is added to seasoned soups and stews. 🐷

Source: Author's notes; *Guinea Pigs* by Kay Ragland (T.F.H. Publications Inc. Hong Kong); "Guinea Pigs for Meat Production" by Dr. Franklin Martin (ECHO, North Ft. Myers Florida 33917 USA); "The current stage and future prospects of guinea pig production under smallholder conditions" (global overview and Cameroon case) by M. Nuwanyakpa, S.D. Lukefahr, et.al. (Livestock Research for Rural Development); and *Environmentally Sound Small-Scale Livestock Projects* (VITA, 1600 Wilson Blvd, Suite 500, Arlington, Virginia 22209 USA). Additional information on caviae can be obtained by writing the American Rabbit Breeders Association Inc., 2401 E. Oakland Avenue, Bloomington, IL 61701 USA, and Heifer Project International, 1015 Louisiana Street, Little Rock, Arkansas 72202 USA.

### *About this book . . .*

Emphasis was placed on readability. Sans serif typefaces, small print (under 10 pts.), and justified margins were avoided. Finally, the Flesch-Kincaid and Bormuth tests were applied to verify the book was reader friendly.