

# **AT** MICROFICHE REFERENCE LIBRARY

A project of Volunteers in Asia

Pictorial Handbook of Technical Devices

by: Otto B. Schwarz and Paul Grafstein

Published by:

Chemical Publishing Company  
155 West 19th Street  
New York, NY 10011 USA

Paper copies are \$14.50.

Available from:

Whole Earth Household Store  
Building D  
Fort Mason Center  
San Francisco, CA 94123 USA

Reproduced by permission of the Chemical  
Publishing Company.

Reproduction of this microfiche document in any  
form is subject to the same restrictions as those  
of the original document.

# PICTORIAL HANDBOOK OF TECHNICAL DEVICES

by Otto B. Schwarz and Paul Grafstein

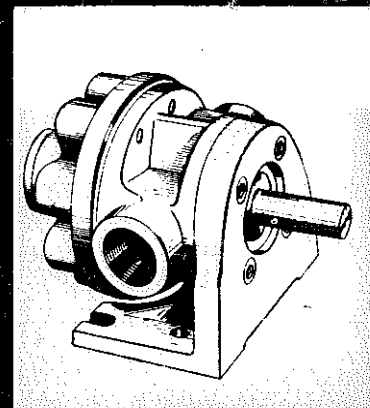
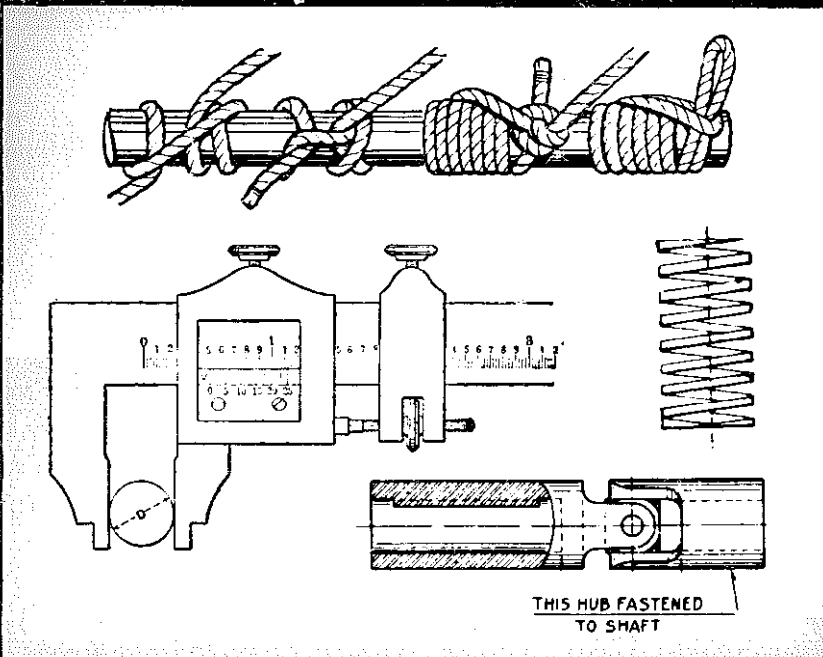
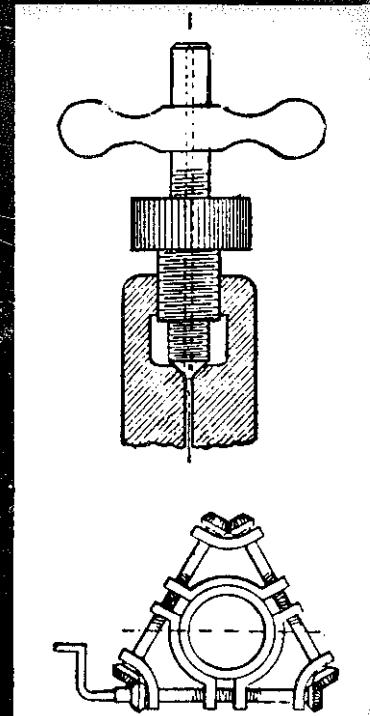
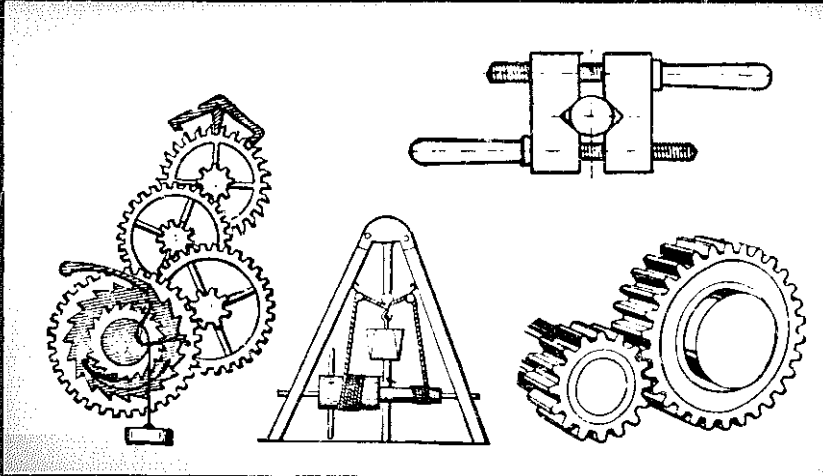

A basic modern reference book showing detailed designs of every conceivable part and device used in constructing mechanical movements and assembled objects. This book contains hundreds of new and up-to-date machine parts useful to the hobbyist and engineer alike.

Over 5,000 Illustrations

---

# PICTORIAL HANDBOOK OF TECHNICAL DEVICES

Paul Grafstein  
Otto B. Schwarz

TO THE PRACTICAL MAN-professional engineer or "Sunday inventor" alike-a properly drawn sketch, cutaway diagram or photograph is worth many pages of description. In this encyclopedic reference guide you will find nearly *5000 illustrations of* mechanical movements, devices, tools and elements, all of them systematically classified and arranged for instant use.

If you design or build machinery of any kind, from the most basic to the most sophisticated, you will probably find exactly the part or movement you need within these pages. Illustrations of related parts are logically grouped for their suggestive value, and, where necessary, an explanation of the method by which they accomplish their particular function is given.

Unprecedented in scope and comprehensiveness, the book is divided into ten main sections, each packed with visual aids to simplify the task of choosing or copying the right part or element to make machinery work: Machine Technology; Magnetics and Electronics; Light and Optics; Fluid Technology; Industrial Processes;

Power Generation; Structural Engineering; Comfort Heating and Cooling; Transducers; and Metrology. Hundreds and hundreds of new and up-to-date machine parts are included in addition to the tried and tested standbys.

In short, this is a time-saving, work-saving, money-saving book that belongs on the desk or in the shop of anyone who works with machinery, from the hobbyist and draughtsman to the manufacturer and patent lawyer.

# PICTORIAL HANDBOOK OF TECHNICAL DEVICES

**PAUL GRAFSTEIN**

B.S.M.E., Cooper Union  
Professional Engineer, New York State

**OTTO B. SCHWARZ**

B.M.E., Cooper Union  
M.M.E., Polytechnic Institute of Brooklyn



1971

CHEMICAL PUBLISHING CO., INC. NEW YORK



© 1971  
CHEMICAL PUBLISHING CO., INC.

Printed in the United States of America

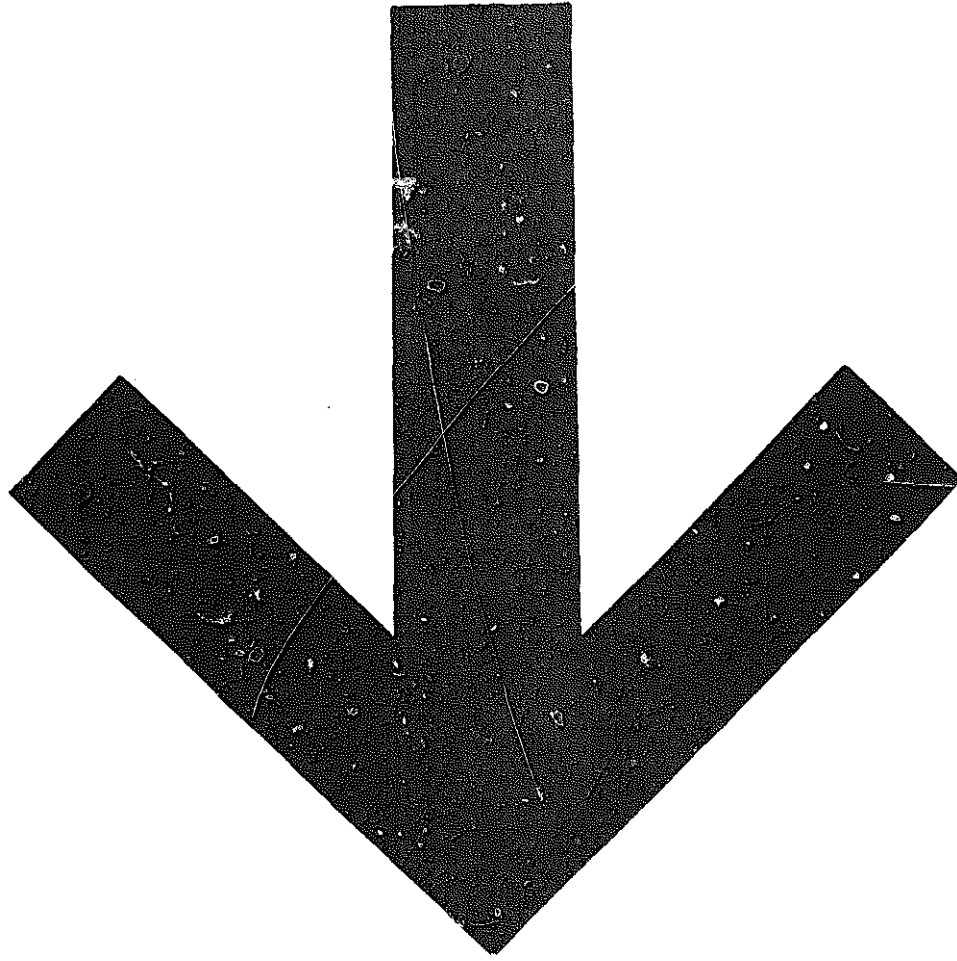

## CONTENTS

<b>I-Machine Technology</b>	<b>1</b>
A--Machine Elements	2
B--Gearing	58
C-Mechanical Transmissions	76
D-Mechanisms and Kinematics	116
E-Fastening and Fasteners	170
<b>II--Magnetics and Electronics</b>	<b>223</b>
A-Magnetics	224
B--Electricity	232
C--Electrical Devices	252
D--Electronic Devices	276
E-Computer Technology	300
<b>III-Light and Optics</b>	<b>317</b>
A-Light Sources	318
B-Lenses, Prisms and Mirrors	322
C-Cameras and Projectors	336
D-Optical Instruments	346
<b>IV-Fluid Technology</b>	<b>353</b>
A-Hydraulic Elements	354
B-Pumps	364
C-Valves	374
D-Hydraulic Components	380
E-Hydraulic Systems	386
<b>V--Industrial Processes</b>	<b>391</b>
A--Tools	392
B-Machinery	410
C-Fabrication Methods	424
<b>VI--Power Generation</b>	<b>441</b>
A-Engines	442
B-Turbines	448
C-Rockets and Jets	456
D-Electric Power	460

<b>VII-Structural Engineering</b>	465
A-Structures	<b>466</b>
B-Cranes, Derricks and Elevators	<b>484</b>
<b>VIII-Comfort Heating and Cooling</b>	497
A-Refrigeration	<b>498</b>
B-Air Conditioning	<b>502</b>
C-Steam Heating	512
D-Heating Systems	<b>520</b>
<b>IX-Transducers</b>	<b>533</b>
A-Displacement Types	534
B-Pressure Transducers	542
C-Temperature	54.8
D-Force and Torque	556
E-Velocity and Acceleration	564
<b>X-Metrology</b>	<b>569</b>
A-Dimensional Measurement	570
B-Volume, Weights and Area	582
C-Pressure and Weight	584
D-Torque and Temperature	588
E-Velocity	590
F-Angles	592
G-Miscellaneous Measuring Instruments and Techniques	594
H-Time	598
Index	800

**I MACHINE TECHNOLOGY**

**A-Machine Elements**

**I-SPRINGS**-Elements to give sizable deflection under load. Used to store energy, alter vibratory characteristics, reduce shockloads, restore energy, or measure force (scales).

**a-Helical compression** spring, plain.

**b-Helical compression** spring, squared and ground ends.

**c-Helical tension** spring with full round hook.

**d**--Same as "c", except threaded plug to fit spring.

**e**--Same as "c", except coned end with swivel hook.

**f**--**Volute** spring, wound in form of paraboloid.

**g-Conical spring**, wound in form of triangle.

**h--Single volute band** spring, telescoping, saves space. Compression at rapidly increasing spring rate.

**j-Torsion** spring, resists torque.

**k--Double volute** spring, for extension or compression. Used in mattresses, seats etc.

**l**-Flat spiral spring for clocksprings etc.

**m-Torsion** spring of ribbon stock.

**n-Torsion** wire spring, resists torque.

**o**-leaf spring with link suspension.

**p-Ribbon torsion** spring. Spring action depends on material.

**q**--**Belleville** spring.

**r**--**Slotted washer** spring.

**s-Ribbon torsion** spring.

**t**-**Curved washer** spring.

**u**-**Finger washer** spring.

**v**-**Wave washer** spring.

SPRINGS

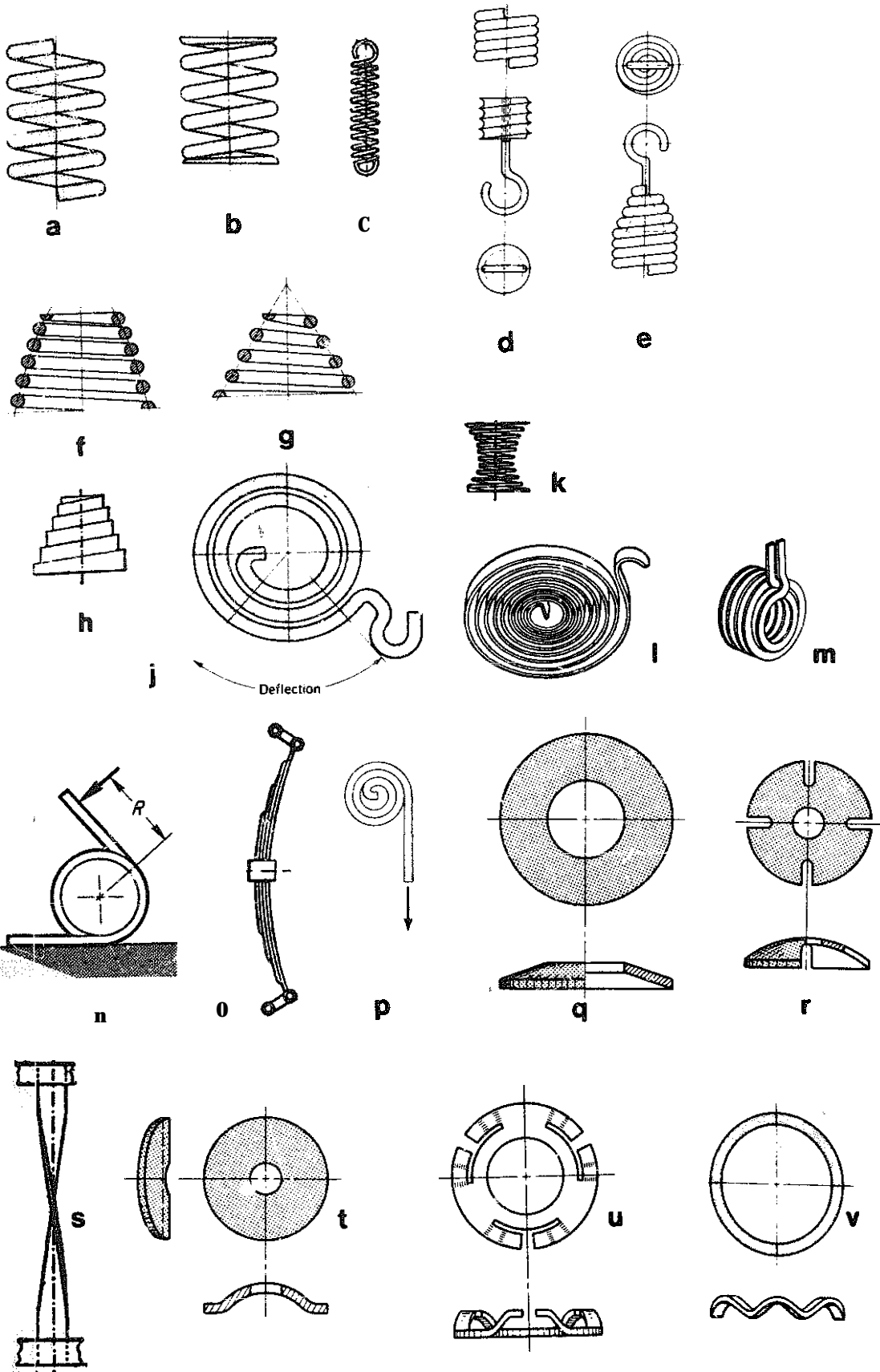

## A-Machine Elements

### I-SPRINGS (Cont)

**w-Split ring** spring, used on drafting instruments, tools etc.

**x-Air cushion** or spring, piston type, like dashpot.

**y-Sear** spring types, as used on guns.

**z-Flat spring.**

**aa-Flat spiral** spring.

**ab-Compound** curved washer spring.

**ac-Compression** spring used for tension load.

**ad-Hair** spring, for precise repeatable torque.

**ae-Neg'ator** spring. A constant force or torque spring, regardless of deflection. (Hunter Spring)

**af-Motor Spring.** Delivers constant torque. Principle: Wound spring, when released recurls to preset curvature. (Hunter Spring)

**ag-Neg'ator** Clamp. Provides constant pressure for widely adjustable opening. (Hunter Spring)

**al-Torsion Bar** spring, as used on automobiles.

**aj-Flex'ator** spring. Load substantially constant over working range.

**ak-Concentric** springs for higher capacity. Note the left and right helix to avoid jamming.

**al-Roiamite**, Wilkes Rolamite can be designed with any desired force-deflection characteristic.

**an-Spindle** shaped compression spring.

**ap-Liquid** spring, compression.

**ar-Liquid** spring, tension.

**as-liquid** spring, double acting. Liquid springs are not shock absorbers, but act in a similar way.



# SPRINGS

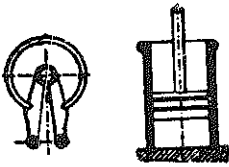

W

X

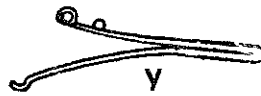

V



Z



aa



ab

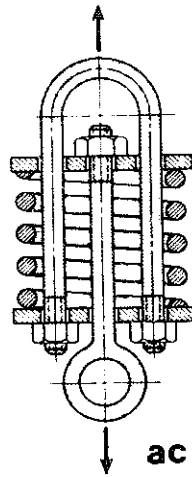

ac

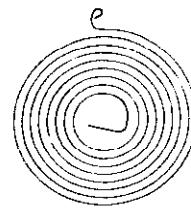

ad

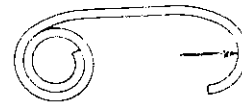

ae

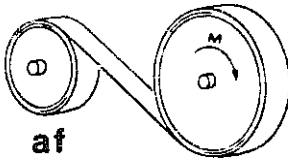

af

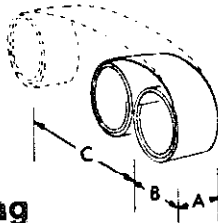

ag

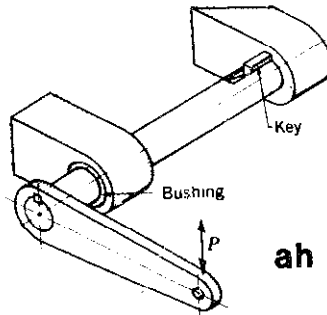

ah

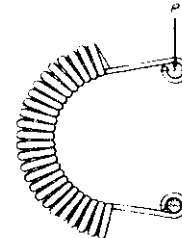

aj

ak

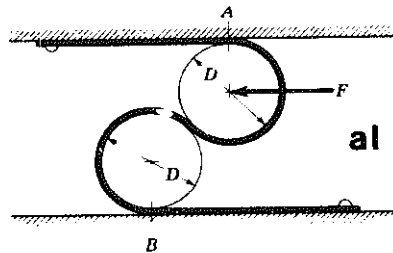
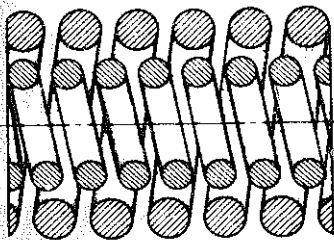

al



am

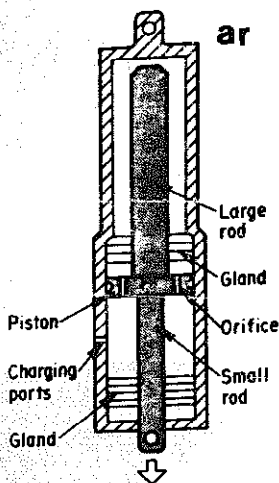

ar

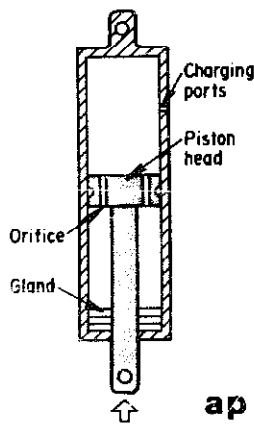

ap

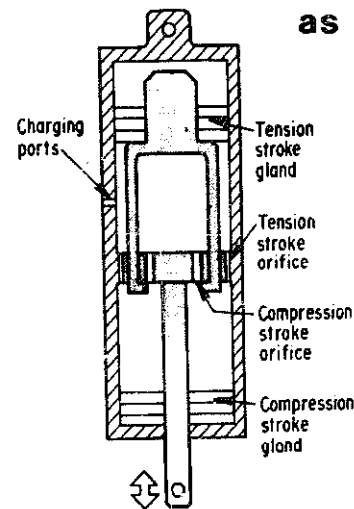

as

## A-Machine Elements

2--CLUTCHES AND BRAKES--Clutches are elements used to connect and disconnect shafts. The following four major classifications may be used: positive clutches, friction clutches, fluid clutches (hydraulic or pneumatic) and electromagnetic clutches. Brakes connect a moving member to a stationary frame.

a-Spiral-jaw clutch. Used for positive, unidirectional drive.

b--Square-jaw clutch. This unit can transmit torque in either direction.

c--Conical clutch. Was used for cars.

d-Friction clutch face with V-grooves.

e--**Spring** friction clutch.

f-Adjustable friction clutch with double grip bearings.

g-Cone friction clutch.

h-Automotive type single plate clutch. Driven disc has friction material on both sides, and transmits torque through splined shaft. Flywheel and pressure plate are connected to engine crankshaft. (Borg-Warner Corp. Rockford Clutch Div.)

j-Double togglejoint friction clutch.

k-One-way clutches. They run free in one direction, and grip instantaneously in the other direction. Also called overrunning or freewheeling clutches.

l-Friction **clutch** bevel gear.

m--**Pin** clutch. Bell crank operates splined disc. Pins engage holes in disc.

n--**Friction** clutch of German design.

p-Twin Cone Friction clutch.

# CLUTCHES & BRAKES

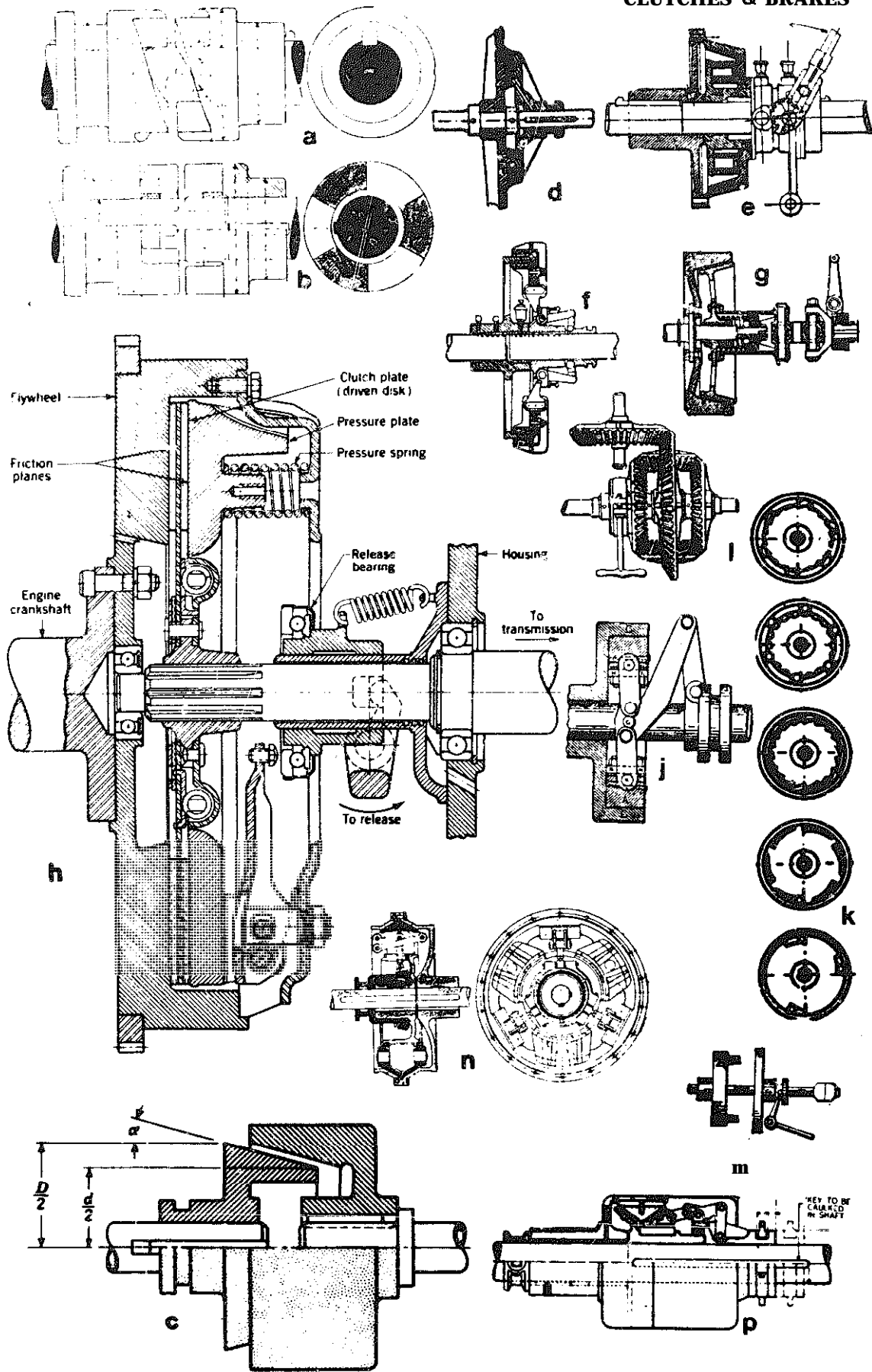

A--Machine Elements

2--CLUTCHES AND BRAKES (Cont)

**r-Maxitcrq multiple-disc** clutch. Designed for wet or dry operation. If sleeve moves to left, wedge depresses lever which in turn presses the plates together. Position of adjusting ring determines plate pressure. (Carlyle Johnson Machine Company)

**s-Fawick Airflex** clutch. Clutch actuated by compressed air. The actuating tube is part of the driving member, and carries the friction shoes. When compressed air expands tube, shoes clutch driven member. Torque is a function of the air pressure. (Fawick Airflex Division, Eaton. Yale and Towne Inc.)

**t-Fawick** clutch, **standardized for punch presses.** To save power for short-time peak loads, the clutch is incorporated into flywheel. Air cylinder, timing switch etc. are supplied as standard unit.

**u-Centrifugal** clutch. For smooth load pick up. Clutch engages through centrifugal force so motor can start easily. Note, that as driven member comes up to speed, the total torque capacity increases, since the shoes in the driven half engage the driver section. (Formsprag Company)

**v-Mercury centrifugal** clutch. As driving member of clutch increases speed, centrifugal force drives mercury out of reservoir, forcing shoes against drum with integral pulley. (Automatic Steel Products, Inc.)

**w,x-Formsprag overrunning** clutch. Specially shaped wedges "x" are held in contact with inner and outer race by garter spring. In the drive direction, wedges (sprags) lock the races. Freewheeling, sprags tilt and sliding action occurs. (Formsprag Company)

**y-Caliper disc** brake. Wheel disc rotates, caliper is on non-rotating member. Actuated, caliper presses shoes against disc. (Aviation Products Division, The Goodyear Tire and Rubber Company)

# CLUTCHES & BRAKES

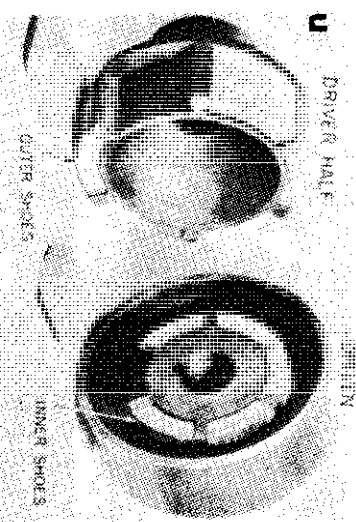
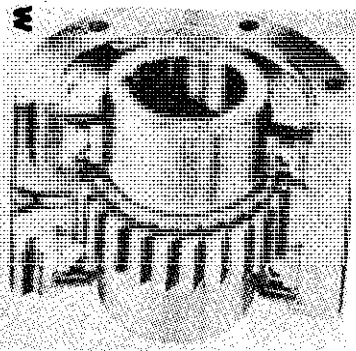
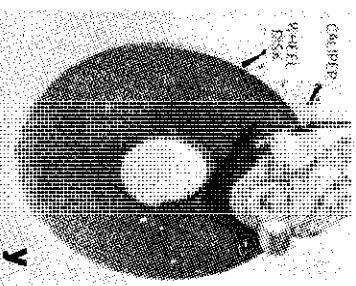
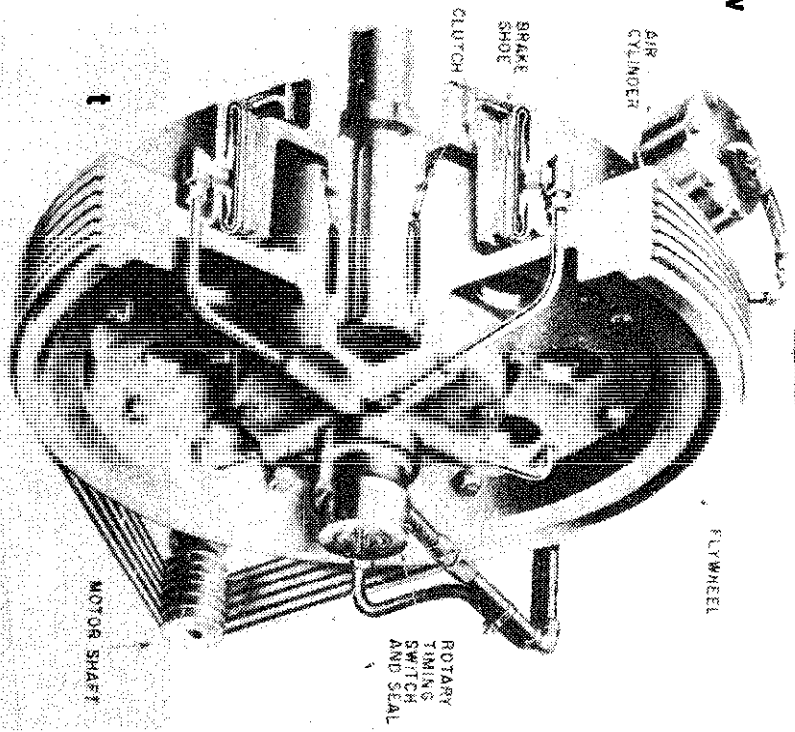
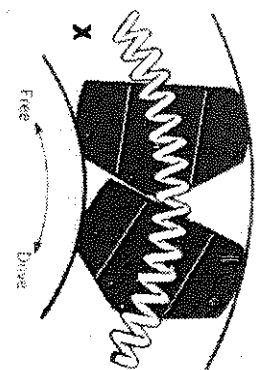
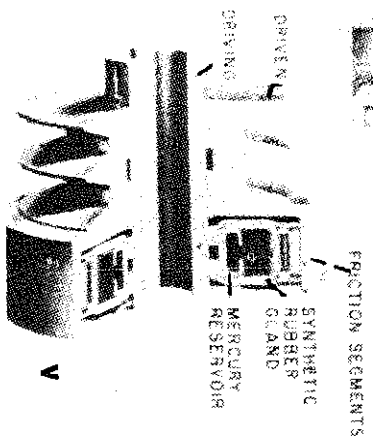
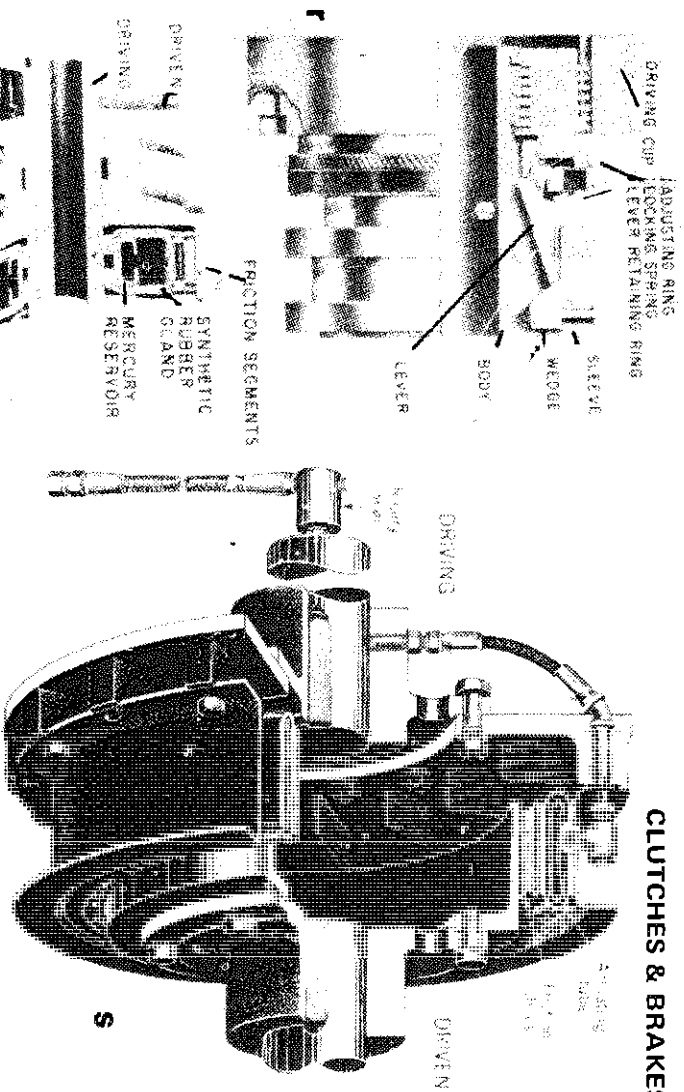

## A-Machine Elements

### 2-CLUTCHES AND BRAKES (Cont)

**z-Magnetic particle** clutch. Ferromagnetic particles are magnetized by the field coil current. Shear resistance of particles depends on current intensity. Note that this unit mounts directly on a shaft on a standard C-face motor. (Electric Products Div., Vickers Inc., Sperry Rand Corp.)

**aa-Hydraulically operated automotive** brake, single cylinder. When actuated, two hydraulic pistons in common cylinder press against brake shoe levers forcing them to engage brake drum of wheel. (Drum not shown.) Cams adjust for wear.

**ab**-same as "aa", but two hydraulic cylinders. Both shoes self energizing.

**ac**-same as "aa" except two shoes with single anchor pin and adjusting link.

**ad-Simple handbrake**, used on hoists etc. Applied force usually hydraulic.

**ae-Double shoe** brake. Pull on lever releases brake. Fail-safe type.

**af-Combination disc and jaw** clutch. The purpose of the discs is to pick up the load. The purpose of the jaws is to prevent slipping. (Rockford Clutch Div., Borg-Warner Corp.)

**ag-Helical spring** clutch. Load picked up if latch on end of coil is withdrawn. To release clutch, latch is reengaged, causing spring to unwind slightly.

# CLUTCHES & BRAKES

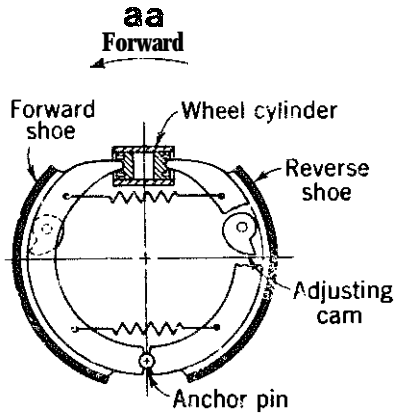
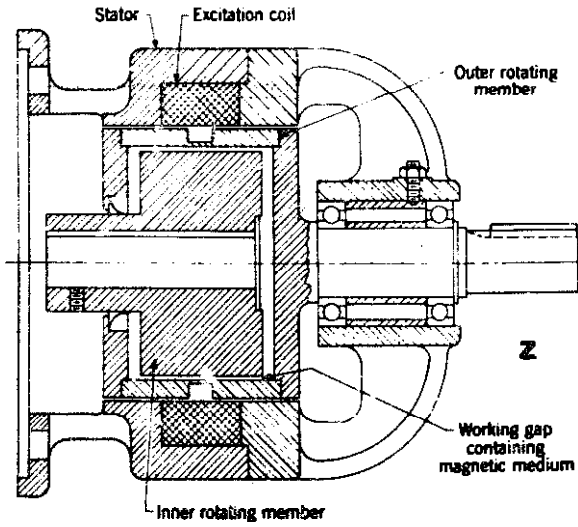

**ab**  
Forward

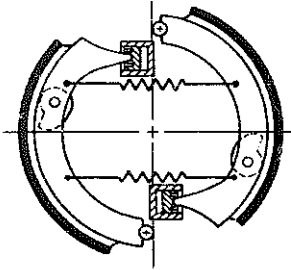

**ac**  
Forward

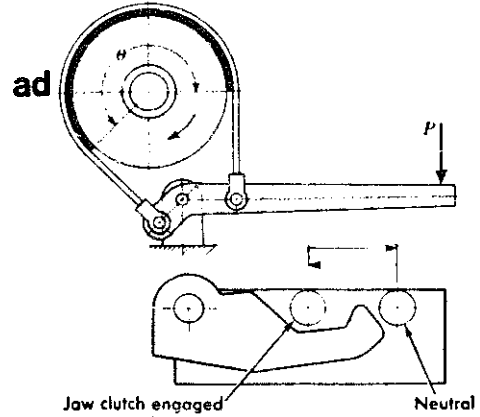
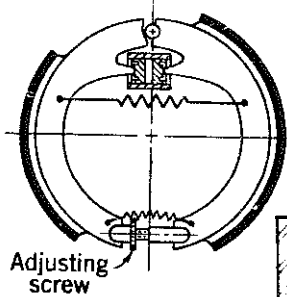

**ag**

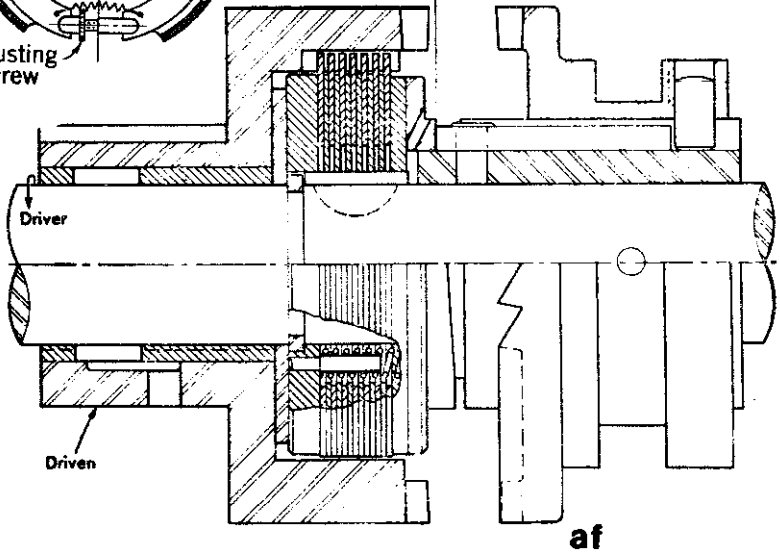
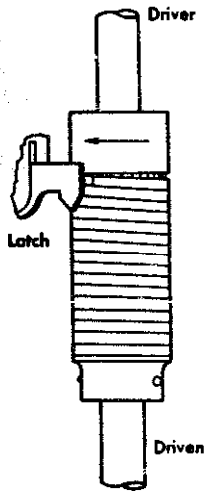

**ae**

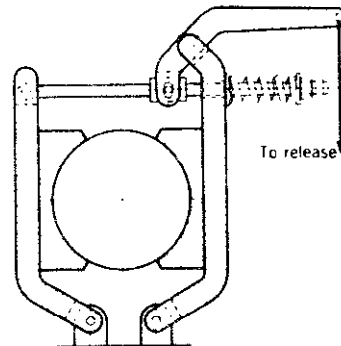

## A-Machine Elements

3-RIGID COUPLINGS. These do not permit misalignment.

**a-Flanged shaft** coupling. Capable of transmitting large torques. If properly aligned, bolts share evenly in carrying load.

**b-Keyed** sleeve coupling.

**c-Precision** sleeve coupling for Servo applications.

**d-Split-box shaft** coupling. Key prevents slipping.

**e-Seller's cone shaft** coupling. (Cone Compression Coupling)

**f-Combination, pulley and coupling.** (German)

**g-Flange** coupling with filler piece. (German)

**h-Friction clip shaft** coupling (sleeve type)

**j-Plain** sleeve coupling, keyed.

**k-Multi-jaw** coupling. Used for light loads only

**I-Flange compression** coupling. Double coned sleeve provides clamping action.



RIGID COUPLINGS

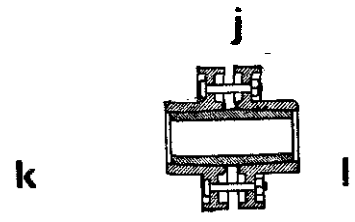
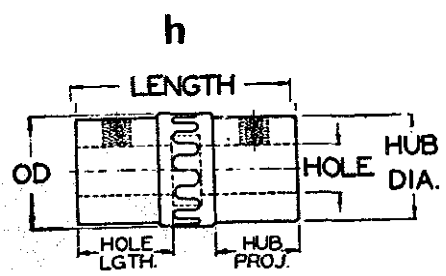
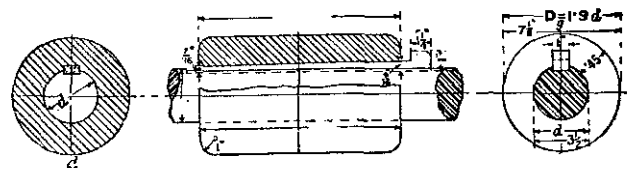
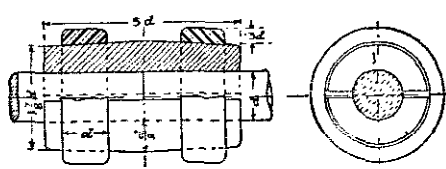
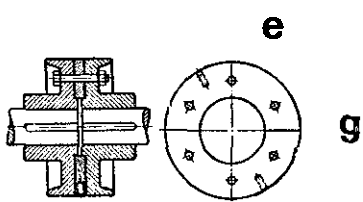
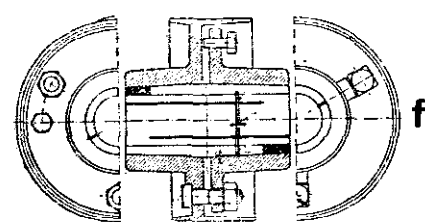
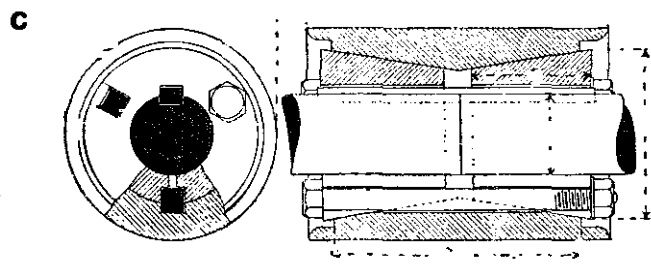
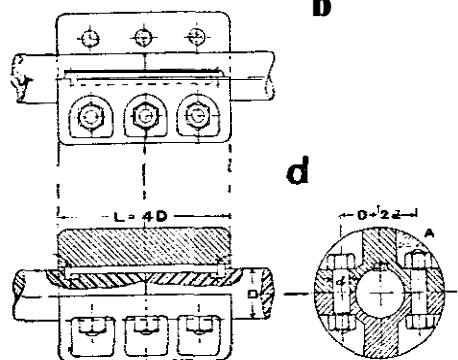
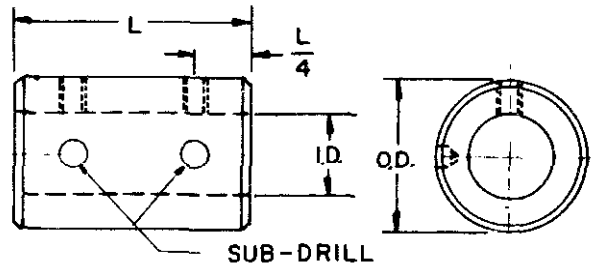
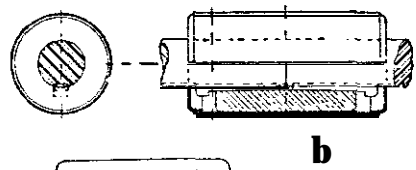
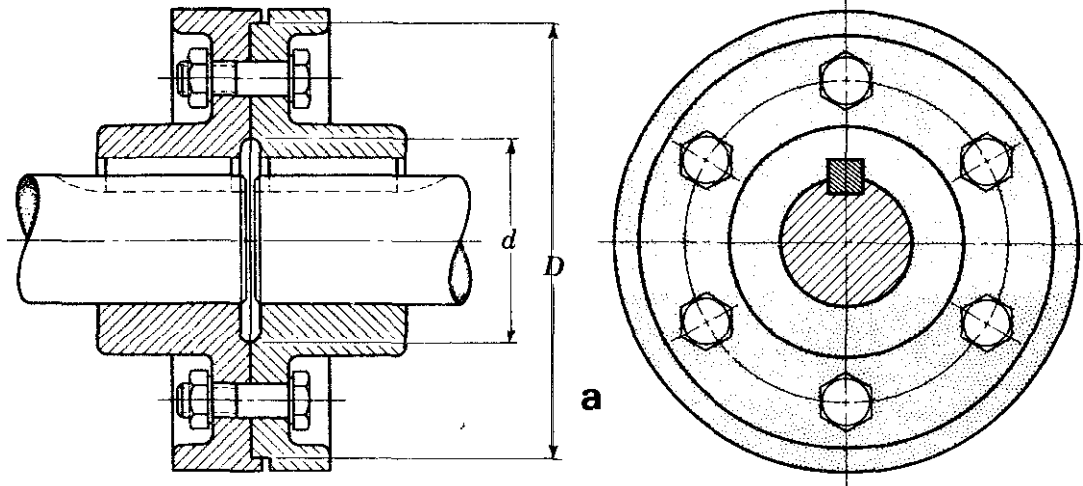

k

**A-Machine Elements**

**4-FLEXIBLE COUPLINGS.** These couplings permit slight misalignment of shafts.

**a-Flexible coupling.** Jaws with non-metallic insert. (Boston Gear Works)

**b-Reinforced rubber hose with metal hubs.** Flexibility, shock-absorbing, vibration dampening. (Guardian Products Corp.)

**c-Same** as "b" but bonded rubber. (Lord Manufacturing Co.)

**d-American flexible coupling.** Considerable axial, angular, and parallel misalignment possible without backlash. (Mechanical Drives Division, Zurn Industries Inc.)

**e-Internal gear type.** Some angular and axial misalignment possible. (Ajax Flexible Coupling Company)

**f-Roller chain and sprocket type.** Easy to disassemble by opening roller chain. (The Diamond Chain Company)

**g-Flexible-ring coupling.** Permits all types of minor misalignment. (Thomas Coupling Div. Rex Chainbelt Inc)

**h-Oldham coupling.** A floating center permits all three types of minor misalignment.

**j-Falk Steelflex coupling.** The resilient member is an alloy-steel grid spring. As load increases, tapered grooves shorten unsupported length of spring. (Falk Corporation)

**k-Ajax flexible coupling.** Axial steel pins ride in bronze bushings mounted in resilient rubber bushings.

**I-Morflex coupling.** Permits considerable axial misalignment. (Morse Chain Co., Div. of Borg-Warner Corp.)

**m-Metal bellows** permit considerable misalignment. Used mostly in instrument work, but are available for low horsepower range.

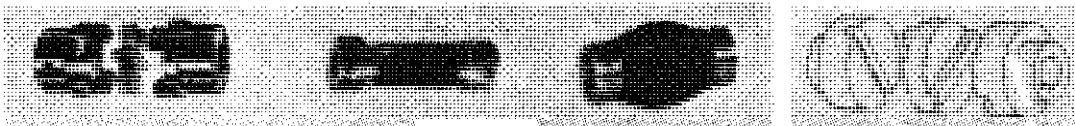

a

b

c

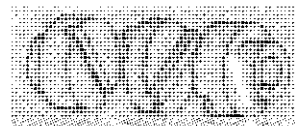

h

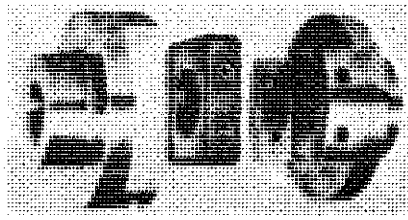

d

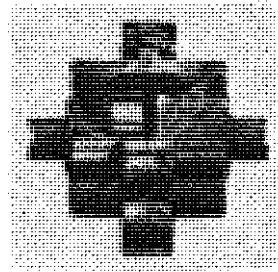
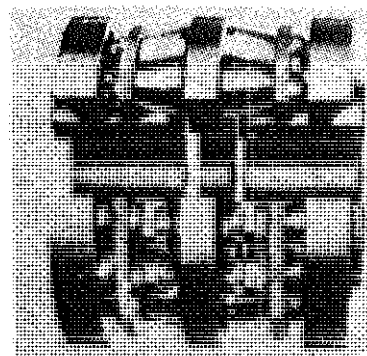

f

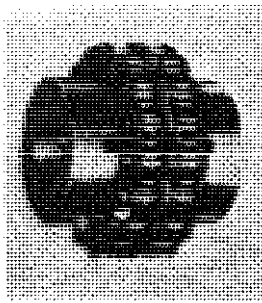

e

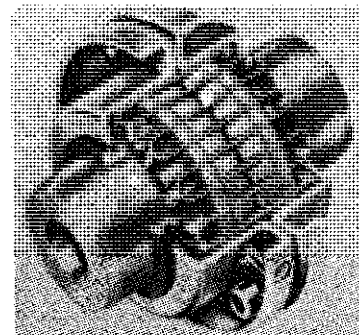

j

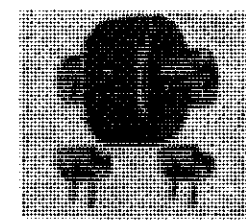

m

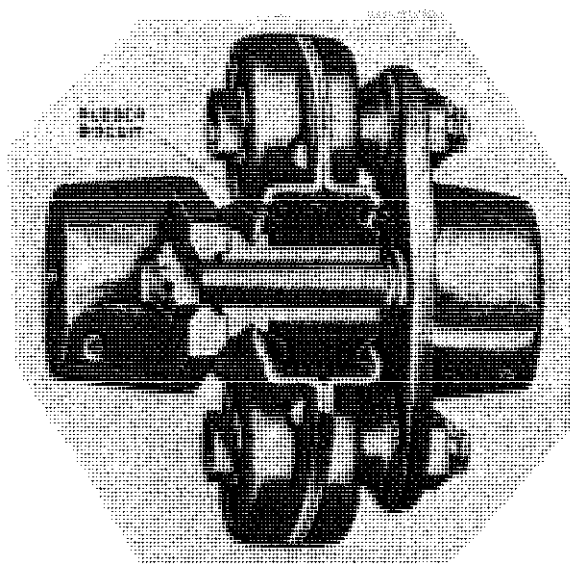

l

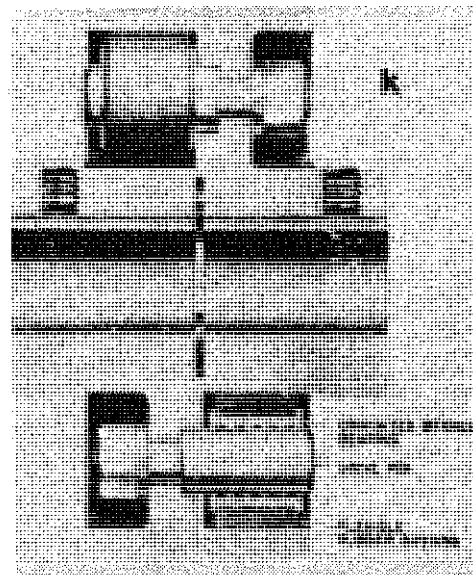

k

## A-Machine Elements

### S-ANGULAR COUPLINGS AND UNIVERSAL JOINTS

**a-Bent-pin coupling.** Angular coupling for shafts at any angle, (shown at 90°) consisting of four bent pins sliding and revolving in holes bored in the ends of shafts.

**b-Angular shaft coupling.** Works well if swivel rod well lubricated.

**c-Flexible angular coupling** for light work.

**d-Pin and slot shaft coupling.**

**e-Sliding contact shaft coupling** with bar sliding in two yokes on the offset shaft.

**f-Hook's coupling** or Cardan joint consists of two forks and an intermediate block, with pins in form of a cross. Most common universal joint. Angles up to 12° recommended, for larger angles rpm must be low.

**g-Application** If angles between input shaft 2 and shaft 3, are the same as between 3 and 4, then constant angular velocity.

**h-Bendix-Weiss constant-velocity universal joint.** Force and motion transmitted through four steel balls. (Bendix Products Div., Bendix Corp.)

**j-Double-link universal joint** for greater angles.

**k-Ball and socket universal joint.**

**l-Rzeppa constant velocity universal joint.** Cage keeps six balls in homokinetic plane, and is guided by two spherical surfaces. (Con-Vel Div., Dana Corp.)

**m-Flexible shaft.** Used for light loads, like portable grinders. Great flexibility. Minimum bending radius of shaft is important. (Stow Manufacturing Co.)

# ANGULAR COUPLINGS & UNIVERSAL JOINTS

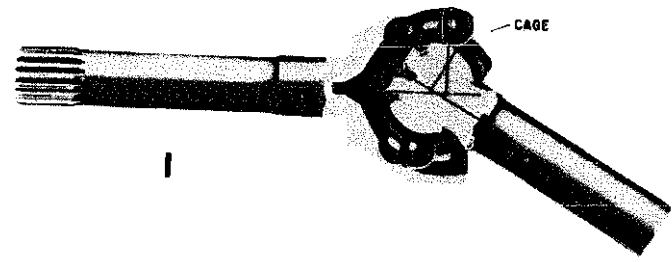
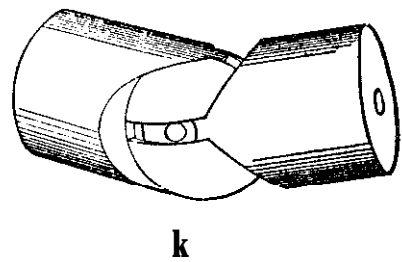
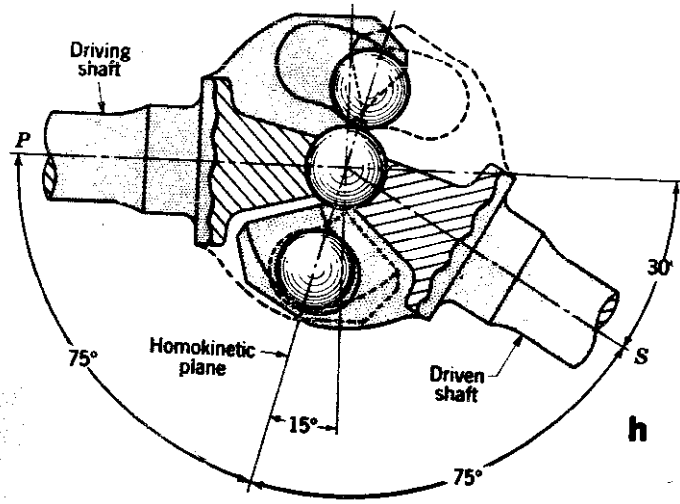
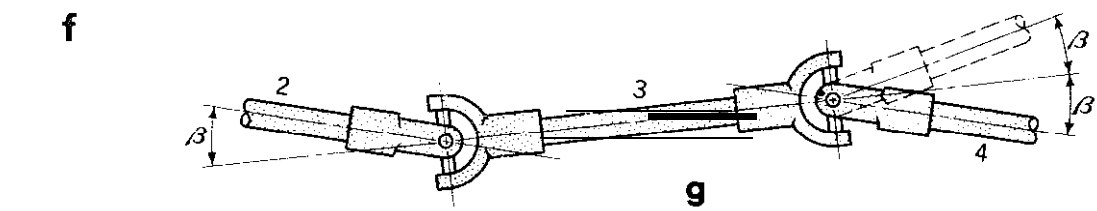
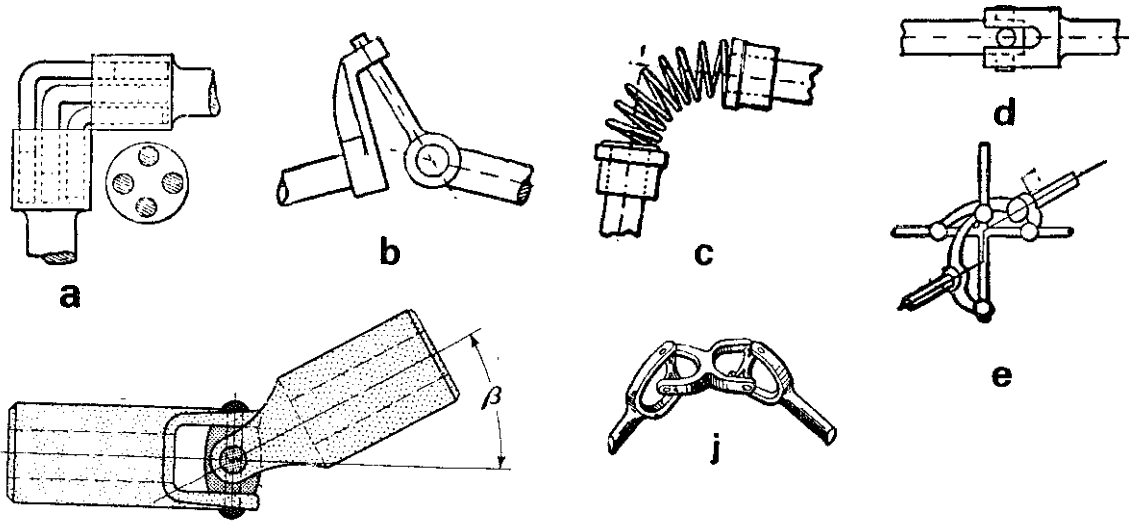

## A-Machine Elements

### 6-GUIDES AND SLIDES

**a-Double V-bed.** Adjustments made by set-screws.

**b-Typical guide bed** for planer.

**c-Deep V-guide,** used for crossheads, etc. which require accurate motion.

**d-Lathe bed** with square guides and adjustment for wear.

**e-Double V-bed** for planing machine.

**f-v-guide** with beveled strip and set-screw.

**g-Guide-bed** with square guides, and replaceable strip adjusted by set-screws.

**h-V-guide** with V-strip. Adjustment by means of set-screws.

**j-Crosshead** guide with two slide bars.

**k-V-guide** with renewable strip. Design often incorporates a slight taper, so strip can take up wear.

**l-V-guide** with adjustment from top.

**m-V-guide** with bevelled adjusting strip.

**n-V-guide** with set-screw adjustment.

**p-Rope** guide.

**q-Rope** guide.

**r-Cross-head** guide with two slide bars.

**s-Engine crosshead** with adjustable guide brasses, set up by taper key and nuts.

**t-Radial slide** for tool holder.

**u-Plain bar** used as guide.

**v-Sliding bed** guided by grooved guides. Screw adjustment.

**w-V-guides.** Loose V-strip adjusted from above.

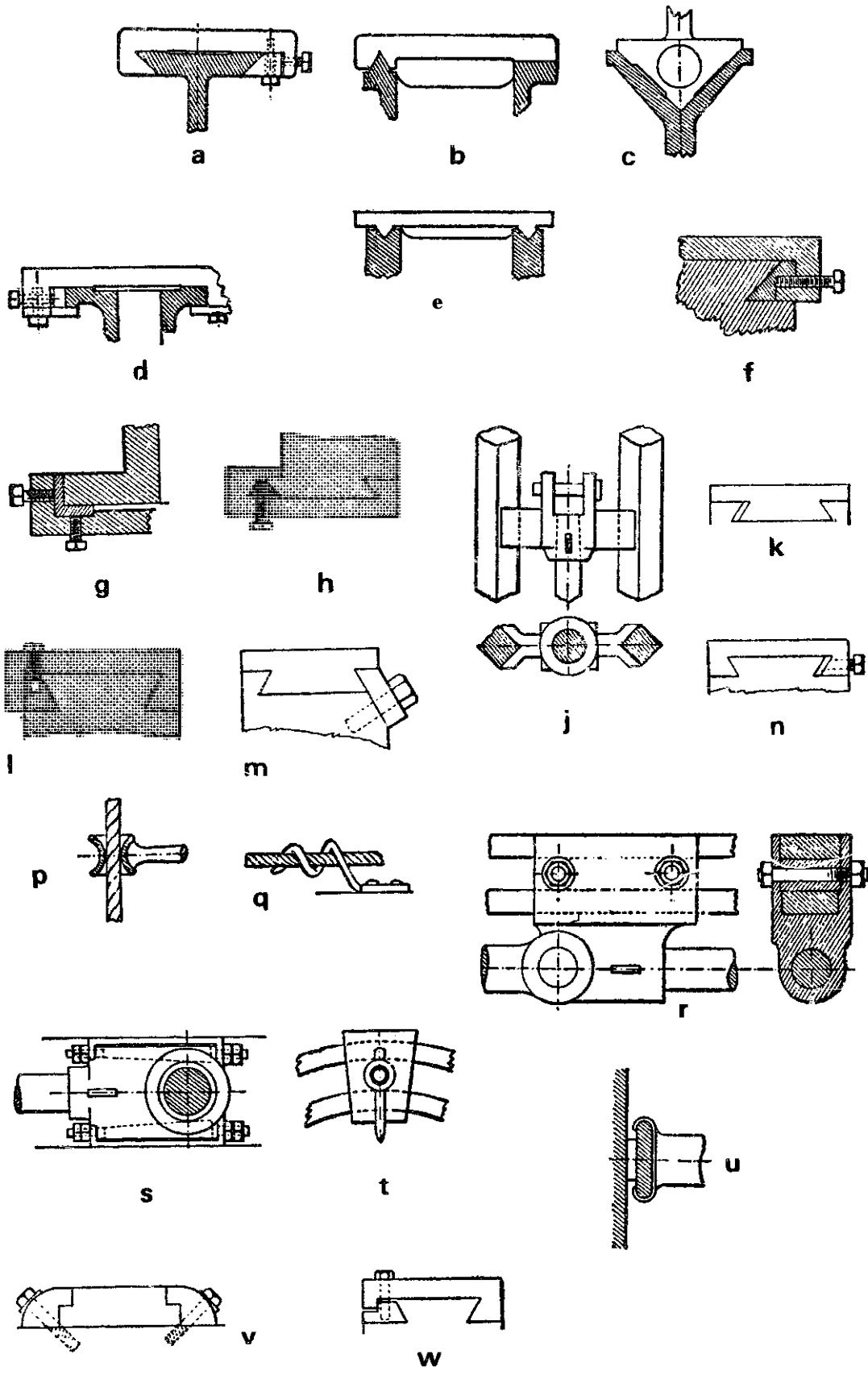

## A—Machine Elements

7—PULLEYS. Pulleys for flat belts are crowned, to prevent the belt from running off the pulley.

**a-Crowned pulley.**

**b-Double coned pulley.**

**c,d,e,f-Sections of pulley rims.**

**g-Detail of pulley with straight arms, and cross section of arms.**

**h-Cross section through pulley with curved arms.**

**j-Pulley with double curved arm.**

**k-Cast split pulley.**

**l-Same as “k.”**

**m-Expanding pulley, adjustable to rim.**

**n-Wooden split pulley.**

**p-Pulley design: arms and hub cast, and then rim fastened to casting.**

**q-Detail: Countersink in flange. Countersunk rivet head pulls rim in.**

**r-Split steel pulley.**

**s-V-belt sheave on cone clutch.**

**t-Timing belt pulley with positive drive belt (timing belt).**



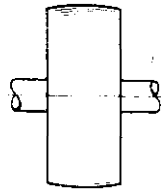

a

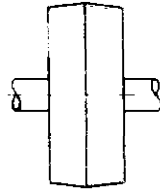

b

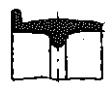

c



d



e



f

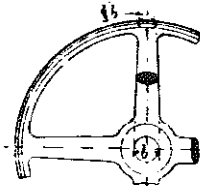

g

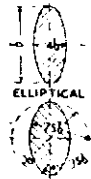

h

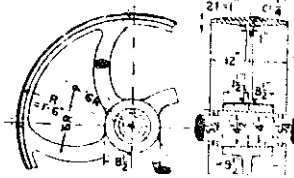

i

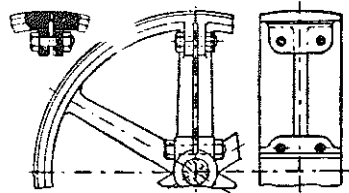
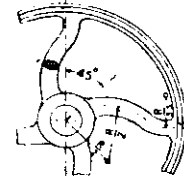

k

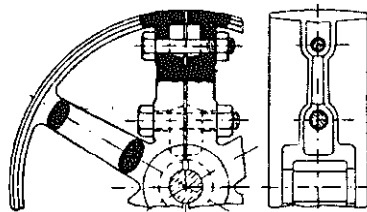

l

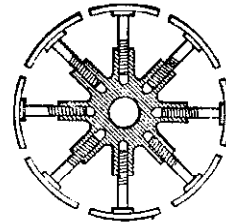

m

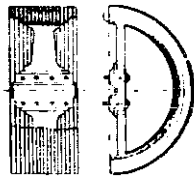

n



o



p

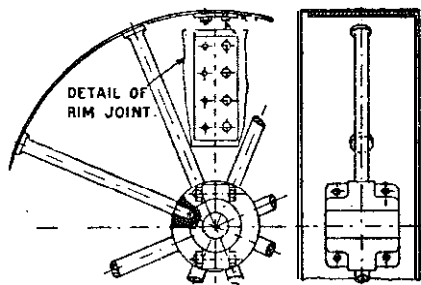

r

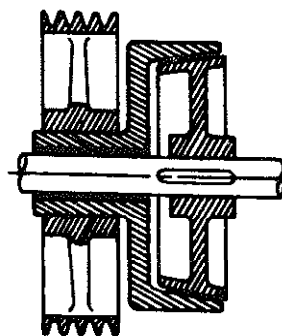

s

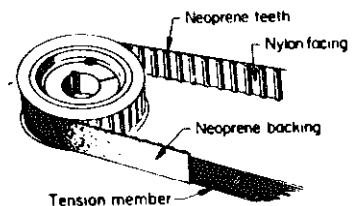

t

**A-Machine Elements**

**8--HANDLES**

**a--Faucet handle.**

**b-Dished handwheel.**

**c-Locked handwheels.** Used if valves have to be operated in a given order.

**d-Ventilated twisted handle.** Used for oven doors etc.

**e-Hand crank.**

**f-Hand-wheel lock nut.**

**g-Hinged spanner** for glands.

**h--Key handle** for cock etc.

**j-Bent looped-end handle.**

**k-Capstan handle.**

**l-Capstan.**

**m-Cross handle.**

**n-T-handle.**

**o-Handle bar.**

**p-Loop handle,** fixed.

**q-Loop handle,** hinged.

# HANDLES

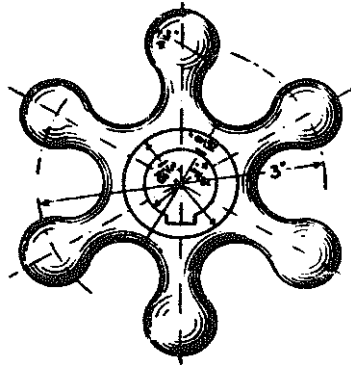

a

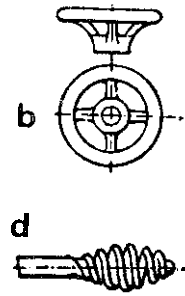
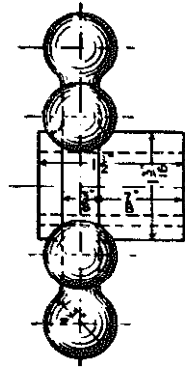

b

d

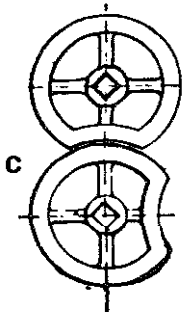

c

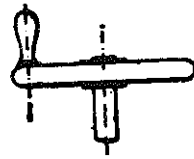

e

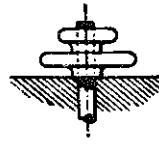

f

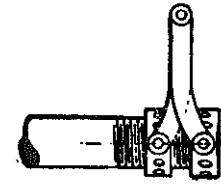

g

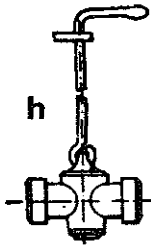

h

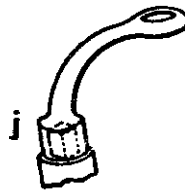

j



k

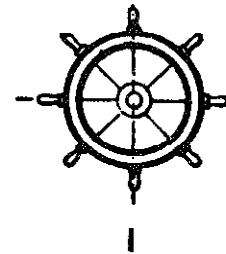

l

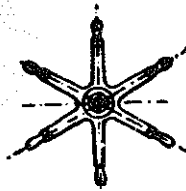

m

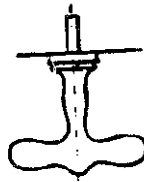

n

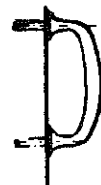

p

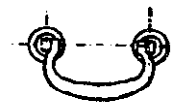

q

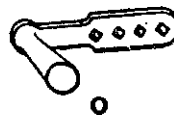

o

**A-Machine Elements**

**&HANDLES (Cont)**

**r-Handle bar.**

**s-Hinged lifting lever.**

**t-Knob.**

**u-Bent handle for radial motion.**

**v-T-handle.**

**w-Stirrup handle.**

**x-Swing-door handle.**

**y-Handle for tap-wrenches.**

**z-Same as "y" but tapered handle.**

**aa,ab-Handles used on machine tools.**

**ac-Handle for tap wrench.**

**ad-Tap wrench handle for small tools, taps etc. (L. S. Starret Co.)**

**ae-T-handle tap wrench. (L. S. Starret Co.)**

**at-aj-Commonly used handles.**

**al-Bow or lifting handle.**

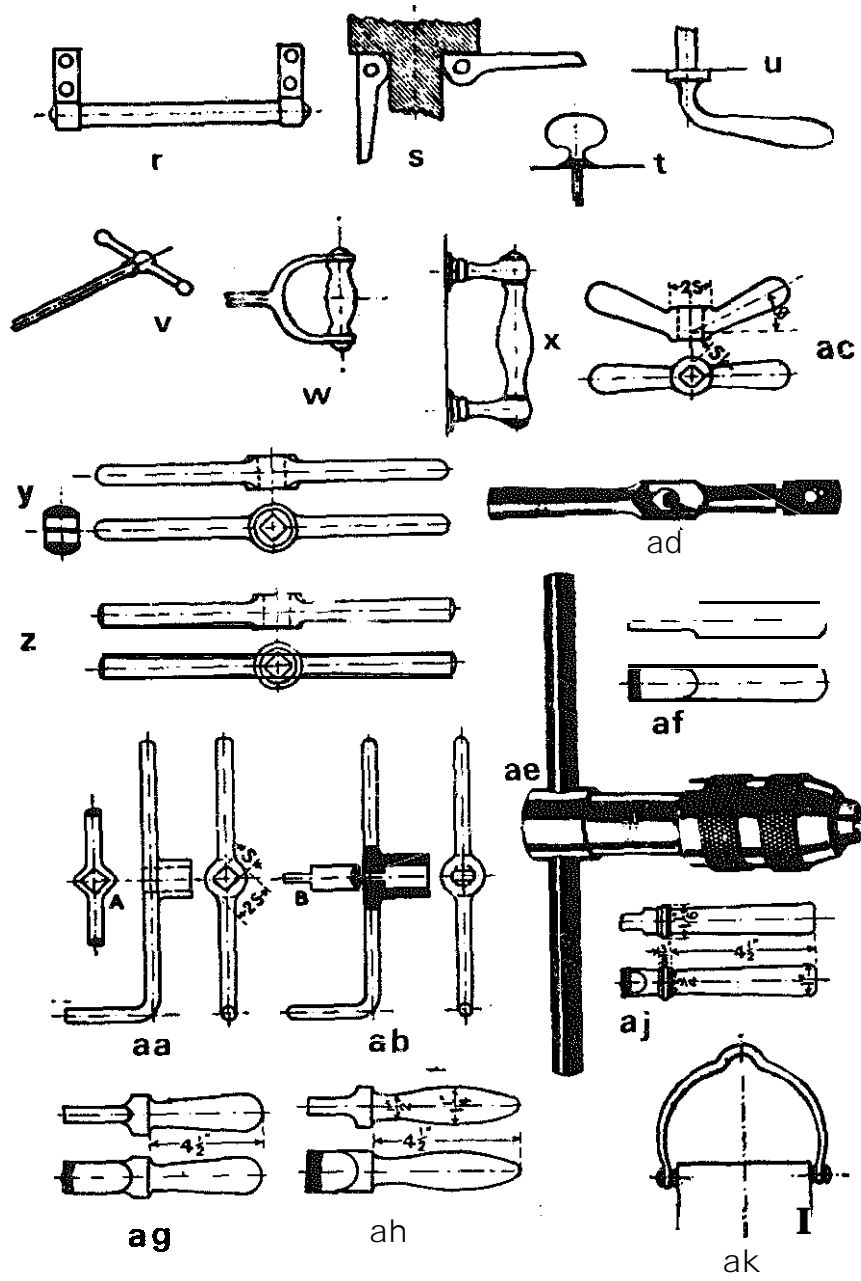

## A-Machine Elements

**9-BALL BEARINGS.** They consist of a grooved inner and outer race, separated by a number of caged balls. Usually made in series as extra light, light, medium and heavy, and in grades ABEC 1 through 9.

**a-Deep-groove** ball bearing. Most used type. Will take thrust and radial load. (New Departure Hyatt Bearings Div., General Motors Inc.)

**b-Filling-notch** ball bearing. Permits insertion of more balls. Takes radial and thrust load. (New Departure-Hyatt Bearings Div., General Motors, Inc.)

**c-Split** ball bearing. Permits greater number of balls to be inserted.

**d-Angular-contact** bearing. Can carry relatively large axial loads, though only in one direction. Usually used in pairs. (New Departure-Hyatt Bearings Div., General Motors, Inc.)

**e-Duplex** ball bearing. Matched pairs for maximum rigidity. Obtainable with specified preload. (New Departure Hyatt Bearings Div., General Motors Inc.)

**f-Double** row ball bearing. Radial contact type shown. Also angular contact type available. (SKF Industries, Inc.)

**g--Self-aligning** ball bearing, externally. Outer race has spherical surface. Used when alignment not precise. (Fafnir Bearing Co.)

**h-Self-aligning** ball bearing, internally. Inner surface or outer race spherical. (The Fafnir Bearing Co.)

**j-Fan or water pump** bearing. Originally designed for automobile use.

**k-Flanged miniature** bearing. For instrument use only.

**I-Pivot** bearing. These miniature bearings often replace jewel bearings. Require conical pivot shaft. (RMB)

BALL BEARINGS

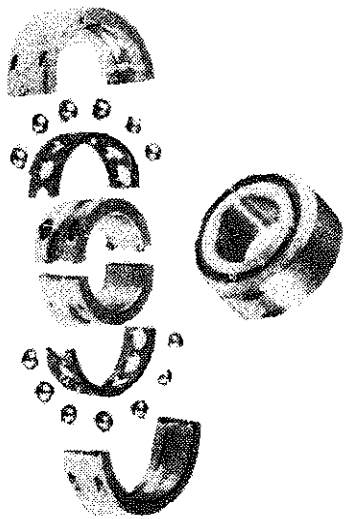
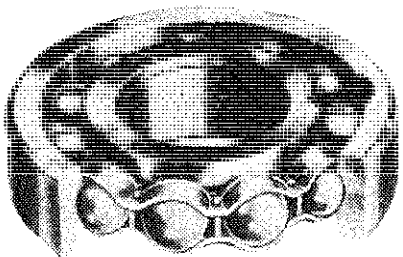
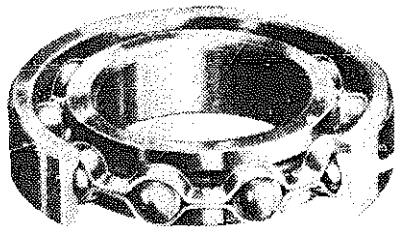

a

b

c

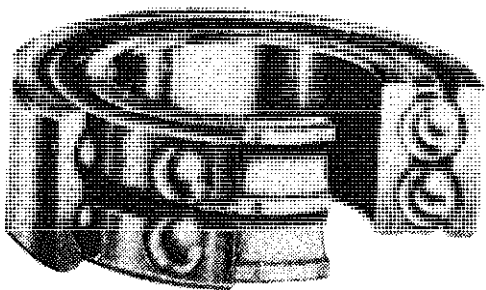
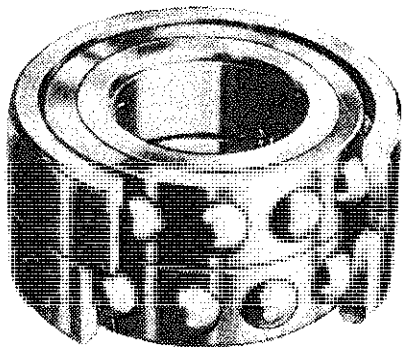
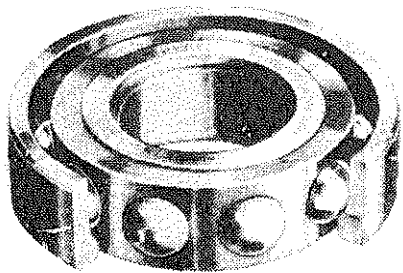

d

e

f

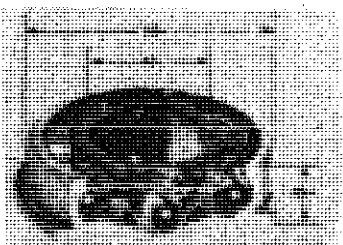
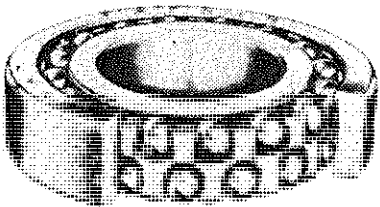
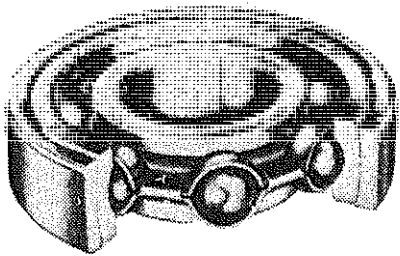

g

5

k

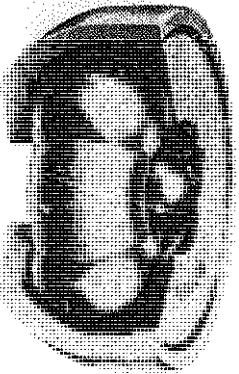

1

1

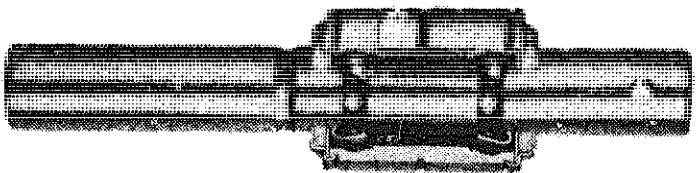

## A-Machine Elements

### 9-BALL BEARINGS (Cont)

**m-Ball bushing.** Unit designed for linear motion. Compared to plain bushing less friction, no binding or chatter, higher speeds possible. (Thomson Industries Inc.)

**n-Ball bearing flange unit.** Flange provided for easier mounting. (Aetna Bearing Company, Textron Div.)

**p-Reciprocating ball bearing.** Used where oscillation or rotation and linear motion occurs.

**q-Single row ball bearing pillow block.** Single row radial ball bearing seated in housing with built-in seals.

**r-Front wheel bearing.** Three piece separable construction, when assembled becomes angular contact bearing. Originally designed for cars.

**s-Ball thrust bearing** This type can carry comparatively high loads. Permissible speeds 60% of radial bearing speeds. (The Fafnir Bearing Co.)

**t-Ball spline.** Used for linear motion and torque transmission. Balls roll in grooves of the outer race and grooves on the shaft. (Saginaw Steering Gear Div., General Motors Inc.)

**u-Snap ring bearing.** Snap ring aids in mounting of bearing. Unit is sealed and shielded on one side. (New Departure-Hyatt Bearings Div., General Motors Corp.)

**v-self-aligning rod-end bearing.** These are useful in linkages. (Fafnir Bearing Co.)

**w-Ball bearing, flanged housing.** (SKF Industries Inc.)



**BALL BEARINGS**

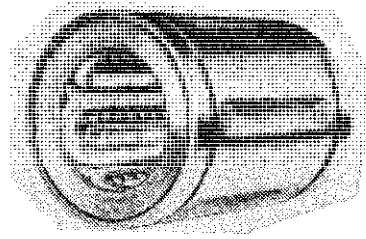

**m**

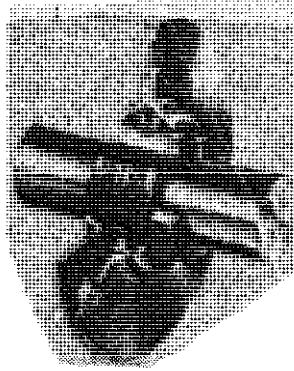

**n**

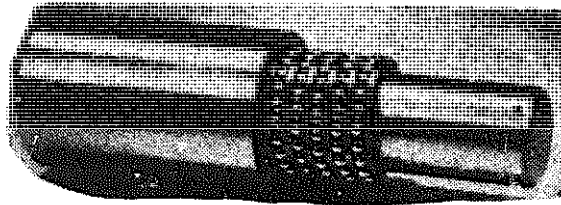
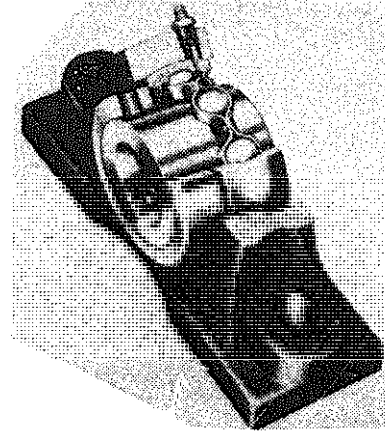

**p**

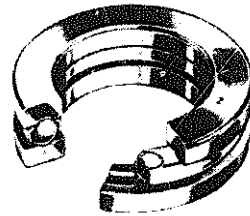

**q**

**s**

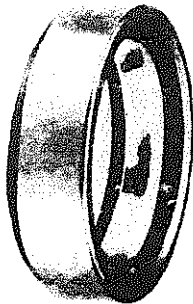

**r**

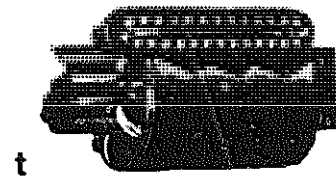

**t**

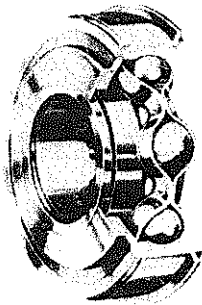

**e**



**v**



**w**

**A-Machine Elements**

**IO-ROLLER BEARINGS AND NEEDLE BEARINGS.** Roller bearings are used when heavier loads are required. The point contact of the ball bearing is replaced by line contact.

**a-Cylindrical** roller bearing. Have low coefficient of friction, and are used for high speeds. (SKF Industries Inc.)

**b-Spherical double-row** roller bearing. Raceways ground in form of a sphere. They can stand misalignment up to  $1\frac{1}{2}^{\circ}$  and can carry thrust loads in both directions. (SKF Industries Inc.)

**c-Spherical thrust** roller bearing. Used for heavier thrusts. (SKF Industries Inc.)

**d-Tapered roller thrust** bearing. (The Timken Roller Bearing Co.)

**e-Tapered roller bearing.** Bearing can carry radial and thrust loads. Bearings used mostly as opposite pairs, arranged with preload. (The Timken Roller Bearing Company)

**f-Spherical-roller bearing pillow block.** Most of these units are heavy duty units and self-aligning. (Rex Chainbelt Inc.)

**g-Needle bearing.** These can carry high loads. Roll needles are closely spaced together and no cage is required. This bearing is designed to run directly on hardened shaft. (Rockwell C 56 to 60)

**h--Double row needle** bearing for heavy duty. This unit has an inner race, so shaft does not require hardening.

**j-Needle bearing cam follower.** High radial load, resistance to shock, good for cam and track movements. (Orange Roller Bearing Co.)

**k-Self-aligning needle** bearing, aircraft-type. Good capacity, permits slight misalignment. (The Torrington Co.)

ROLLER BEARINGS & NEEDLE BEARINGS

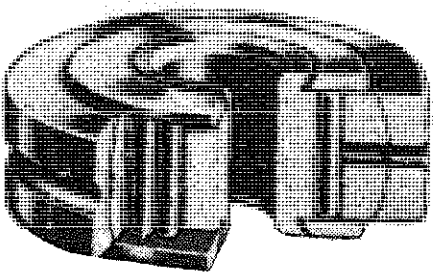
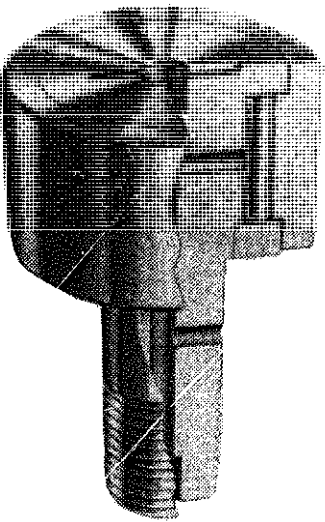
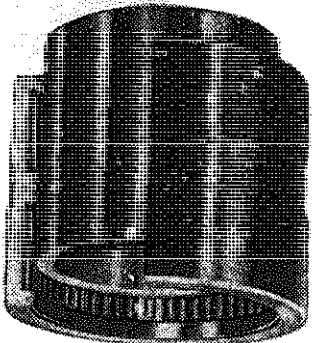
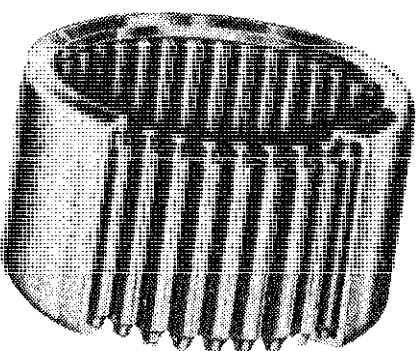
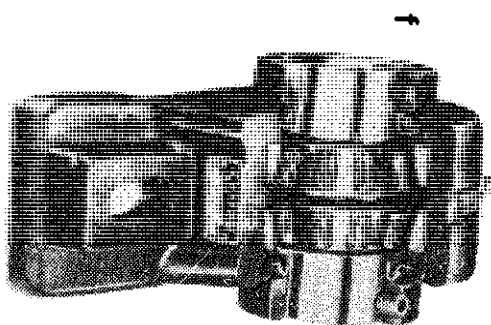
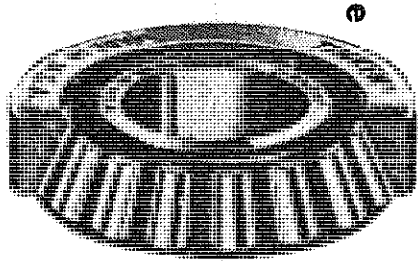
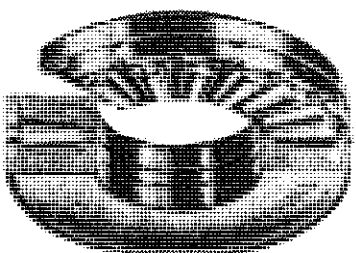
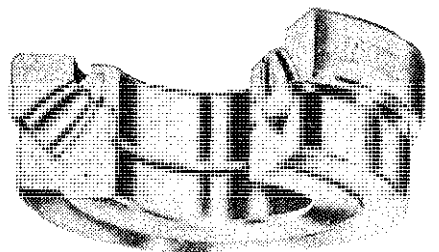
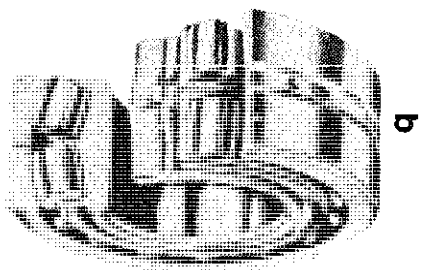
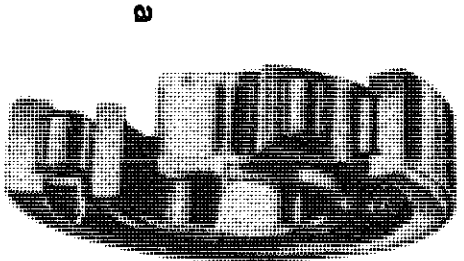

## A-Machine Elements

### 11 -METHODS OF BEARING MOUNTING

**a-Lockwasher, locknut, shaft,** and bearing assembly to shaft.

**b-Typical shaft mounting.** One bearing mounted with lockwasher and locknut to shaft, and clamped to housing by end cap, the other floating.

**c-Duplex bearings before preloading.**

**d-Duplex bearings after preloading.**

**e-Mounting** of single row angular contact type bearings.

**f-Typical arrangement** in motor housing.

**g-Common double row bearing mounting.**

**h-Mounting** of bearing with **snapping.**

**j-Mounting** of **bearing with** wide inner race to housing with internal retaining ring and to shaft by means of two set screws.

**k-Bearing on split adapter.** Total assembly is put on shaft. Tightening of nut clamps adapter to shaft.

**l-Bearing** held against shoulder of shaft by end cap. Shaft is tapped so cap screw can hold plate.

**m-Both bearings locked to shaft.** One bearing clamped to housing, the other floating.

# METHODS OF BEARING MOUNTING

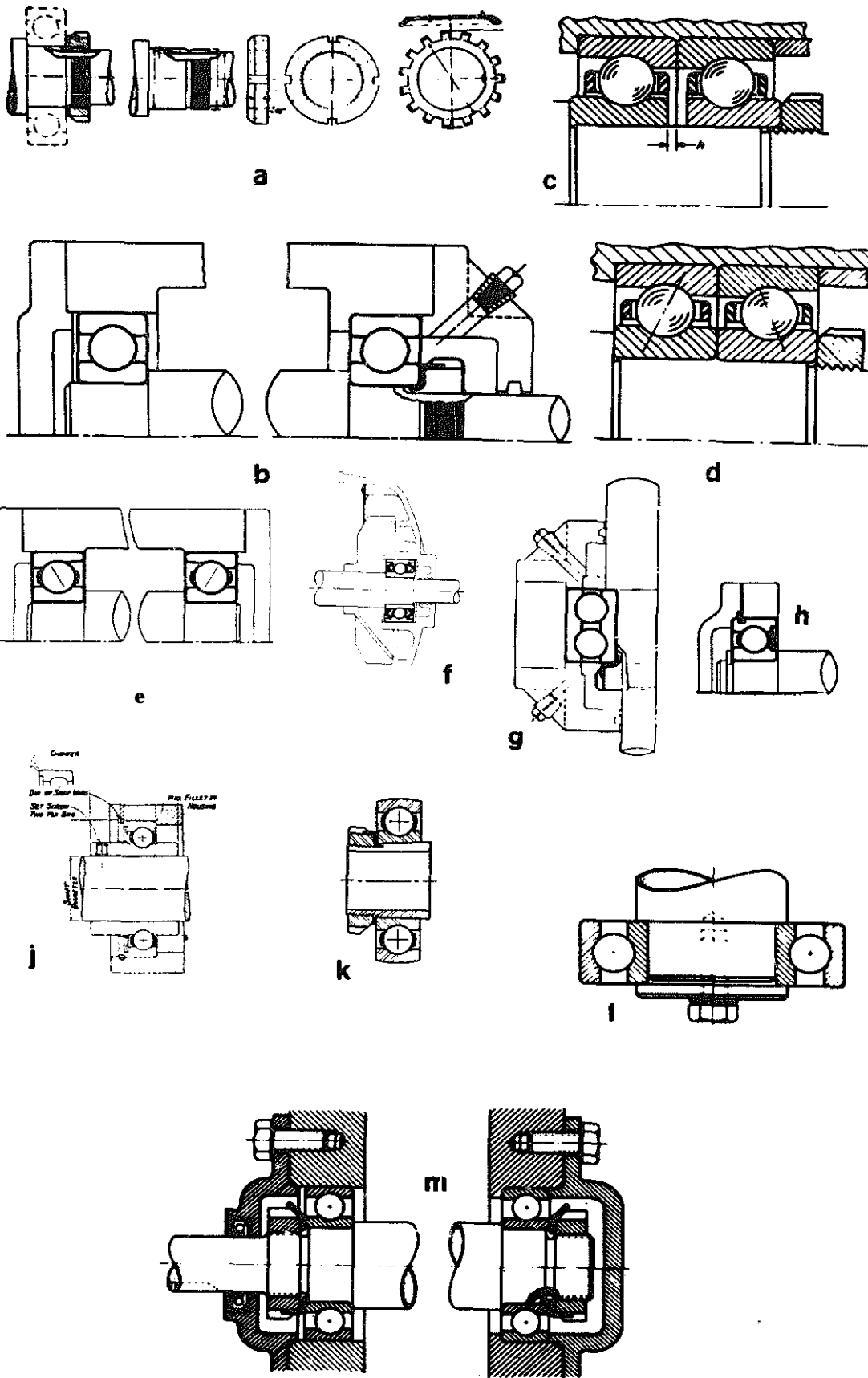

**A-Machine Elements**

12—**PLAIN BEARINGS.** Also called. sliding bearings. Many subdivisions are possible. For example thick film bearings for complete separation of surface types, thin film bearings where surfaces partially contact, and zero film bearings, for bearings without any lubrication.

**a-Solid bearing.** Hole is drilled into housing.

**b-Plain bushing** press-fitted into housing.

**c-Two shoulders** locate shaft axially in split journal bearing.

**d-Double flanged bearing** with oil-grooves.

**e to m-Variou s oil groove patterns.**

**n-Babbit layer** in casting to act as journal bearing.

**p-Shaft shoulder** against bearing takes up thrust.

**q-Multiple thrust collars** for high thrusts to reduce psi, and decrease wear. Mostly replaced now by hydrodynamic thrust bearings.

**r-Pivot** for vertical shaft. Bottom of bearing often V-shaped, steel ball is dropped in, and shaft turns on bearing ball.

**s-Split journal** for turned down shaft.

**t-Bearing metal** fitted in solid strips like a key.

**u-Bearing metal** fitted in solid strips like a key, machined after assembly.

**v-Principle of hydro-static journal bearing.** High pressure from outside source can support loads, even without relative motion between members.

**w-Tilting pad journal bearing.** Used only for special purposes. This design method used on hydrodynamic thrust bearings.

**x-Graphited bronze thrust bearing** has graphite compressed into drilled holes.

**y-Graphited bronze bearing** has graphite compressed into dove-tailed grooves.

**z,aa,ab,ac,ad,ae,af,ag-Methods** to adjust large journal bearings.

**ah-Water-lubricated rubber bearing.**

**aj-Half section of vertical thrust bearing.**

**ah-Half bearing** for car wheel.

# PLAIN BEARINGS

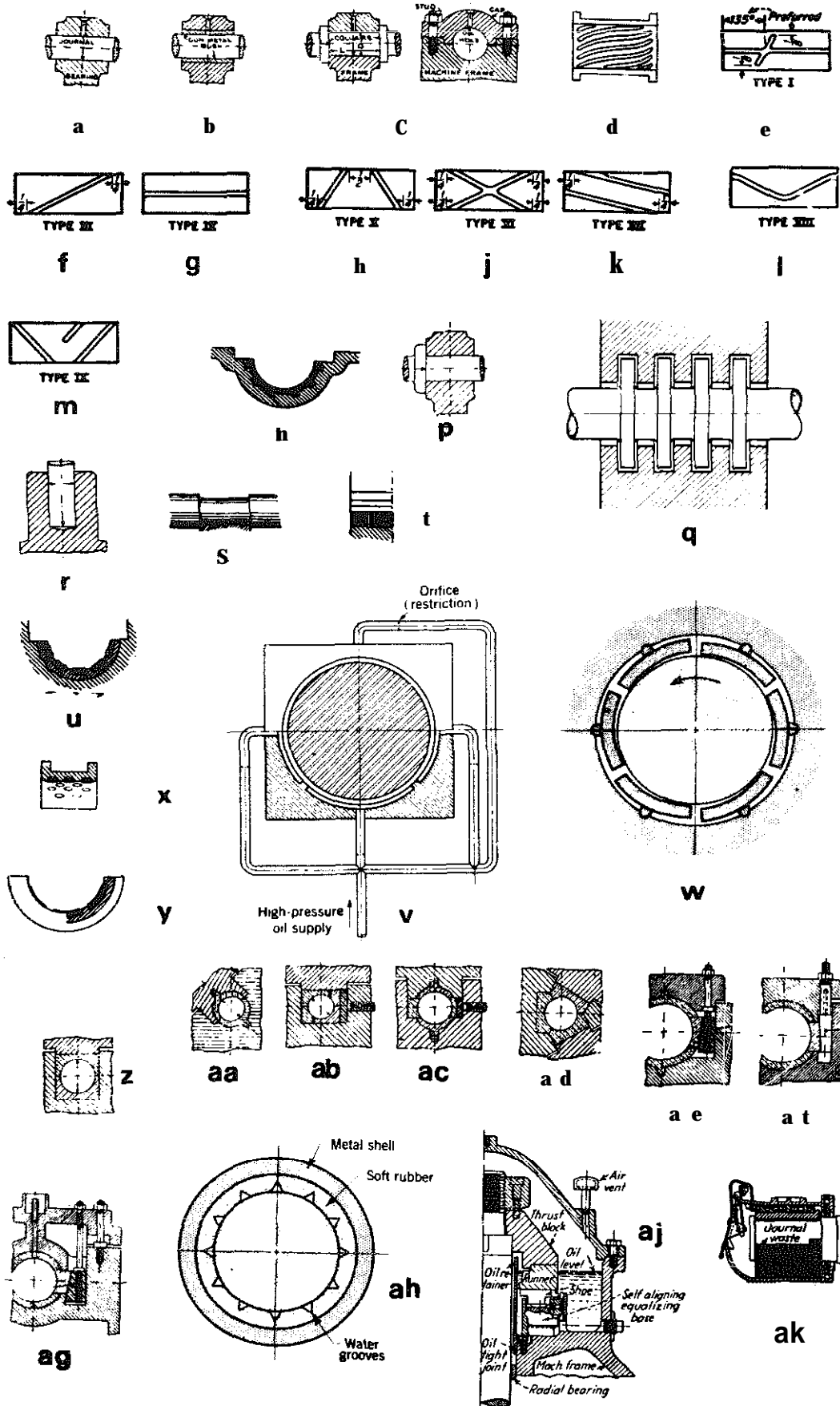

## A-Machine Elements

### 13-BEARINGS, JOURNALS AND HANGERS

**a-Transmission-shaft** bearing. Hanger type with ring oiling.

**b-Typical pedestal.**

**c-Ceiling** hanger, to be attached to ceiling.

**d-Hanger** designed to be attached to **I-beam**.

**e-Self-aligning** shaft-bearing in hanger.

**f-Ceiling** hangers, of German design.

g-Same as "f."

**h-Wall** hanger.

j-Wall hanger.

**k-Ring-oiling** for solid bearing.

**I-Typical modem ring-oiled bearing.** Notice the sealing and air by-pass.  
(Westinghouse Electric Corp.)



BEARINGS, JOURNALS & HANGERS

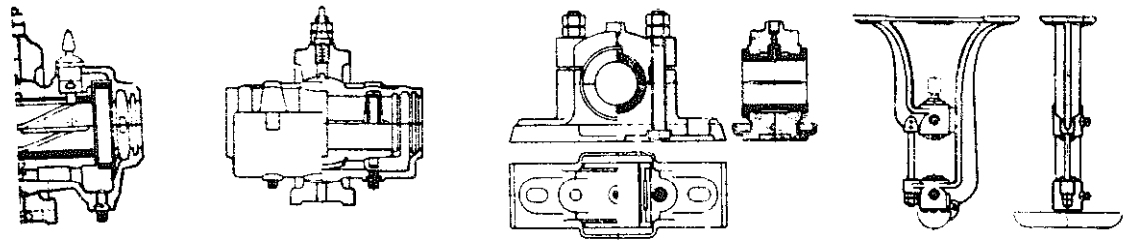

a

b

c

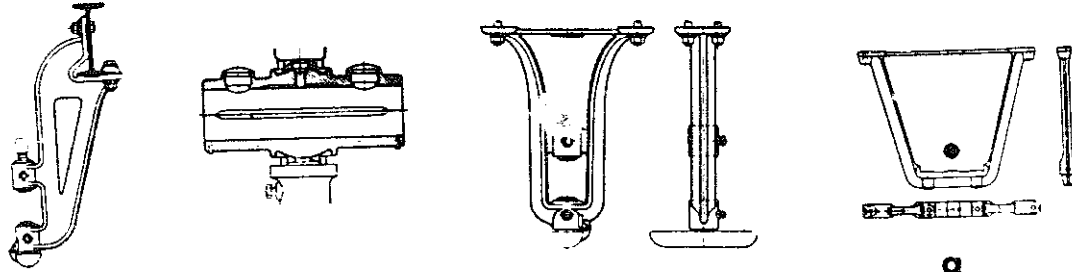

d

e

f

g

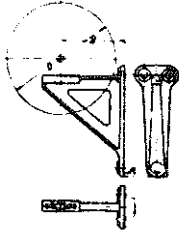

h

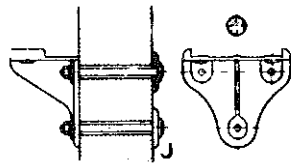

i

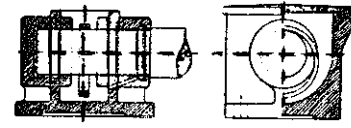

k

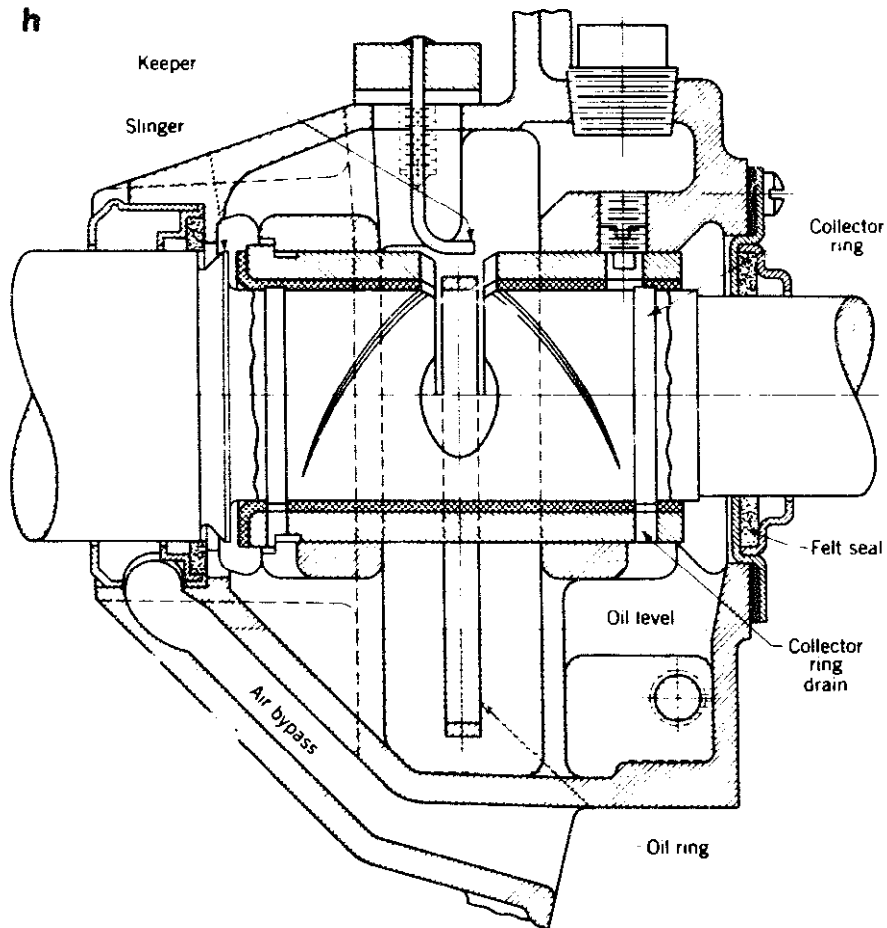

l

**A-Machine Elements**

**14-BEARINGS, MISCELLANEOUS**

**a-Pivot bearing** with cupped steel discs.

**b-Slot bearing** for rising or falling spindle.

**c-Pivot for verticle spindle.** Oil being forced through the channels under pressure, returns from a well to the pump.

**d-Sliding bearing** with vertical or horizontal travel.

**e-Spherical journal** permits shaft to run out of line.

**f-Oval journal** permits shaft to run out of line.

**g-Groove in collar and pin in housing** performs function of thrust bearing.

**h-Ball and socket bearing** permits misalignment.

**j-Plain double bearing** with one cap and bolt.

**k-Ball and socket arrangement** for shafts out of line.

**l-Tapered shaft** for mounting grinding wheels etc.

**m-Horizontal pivot** and set screw. Set screw should have locknut.

**n-Vertical instrument pivot.**

**p-Double-V bearing** accomodates various shaft sizes.

**q-Half bearing.** Pin prevents shaft to leave bearing. Pin may not be necessary.

**r-Adjustable (intermediate) bearing** for hanging shaft.

**s-Vertical pivot** with hardened screw. Screw should have locknut.

**t-Bearing for rocker arm** with tapered spindle. Wear is taken up by the screw.

**u-Self-aligning bearing.**

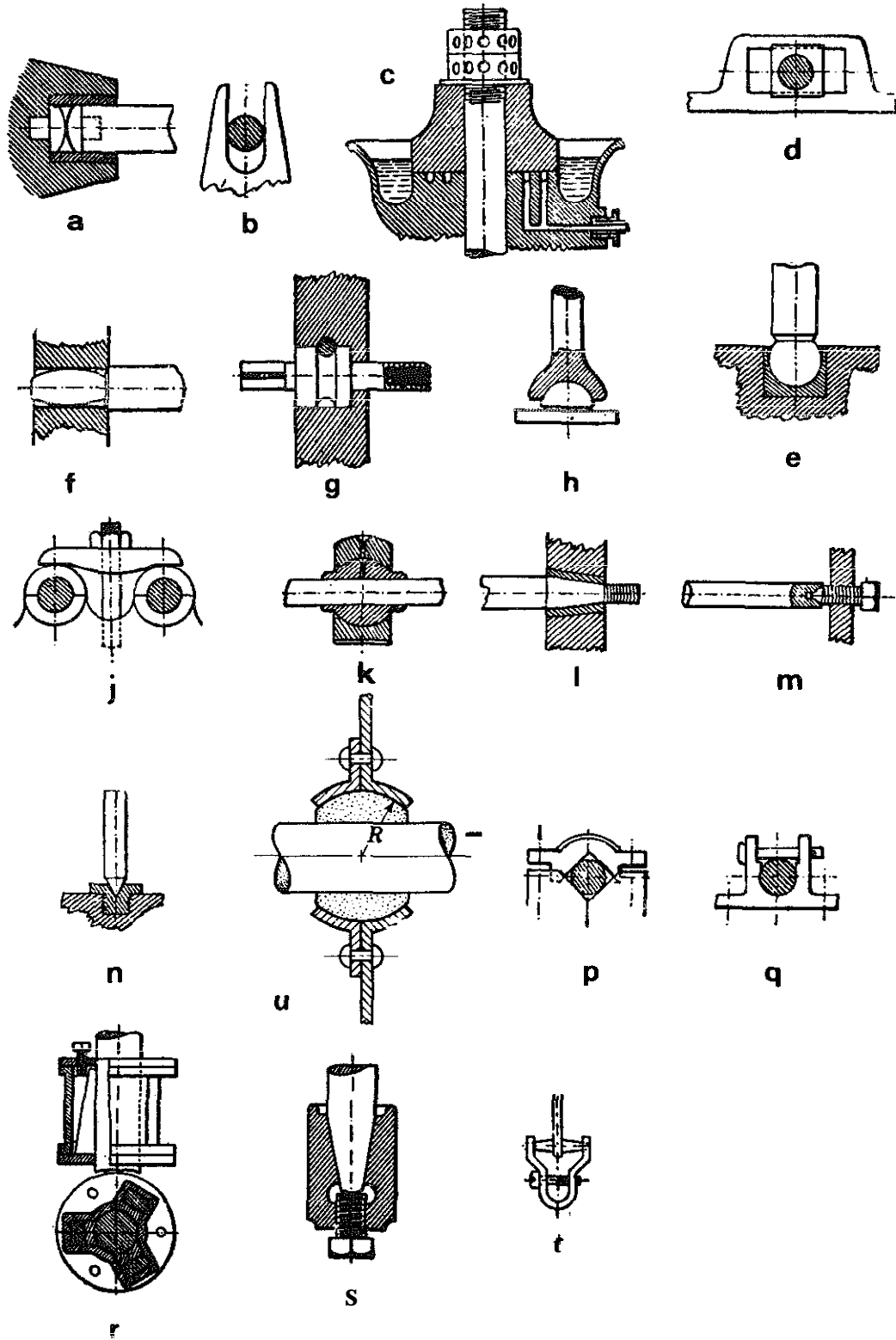

## A-Machine Elements

### 1 S-HINGES

**a-Common double leaf hinge.**

**b-Elevator hinge,** causes door to rise slightly on opening. It will then close by means of its own weight.

**c-Pintle hinge.**

**d-Hinge** for a door that lies flat against wall at either side when open.

**e-Link hinges.** Used for reversing car seats.

**f-Hinge** for heavy door.

**g-Door hinge.**

**b-Door hinge.**

**j-Gate hinge.**

**k-Door spring hinge.** Roller is attached to spring. Cams on door press against roller and return door to closed position.

**l-Multiple door hinge.** Uses one bolt only.

**m-Link hinge** for trap door. Allows door to lie flat when opened.

**n-Hinge** permitting door to lie flat against wall.

**p-Cup and ball hinge.**

**q-Tape hinge,** similar to folding door use.

**r-Door hinge** with tension springs, return door to closed position.

**s-Link hinge** to reverse a door, shutter etc.

**t-Door hinge** with return mechanism.

**u-spring hinge.**

**v-Hinged handle** with **hinge hasp.**

**w-Slip pin hinge.**

HINGES

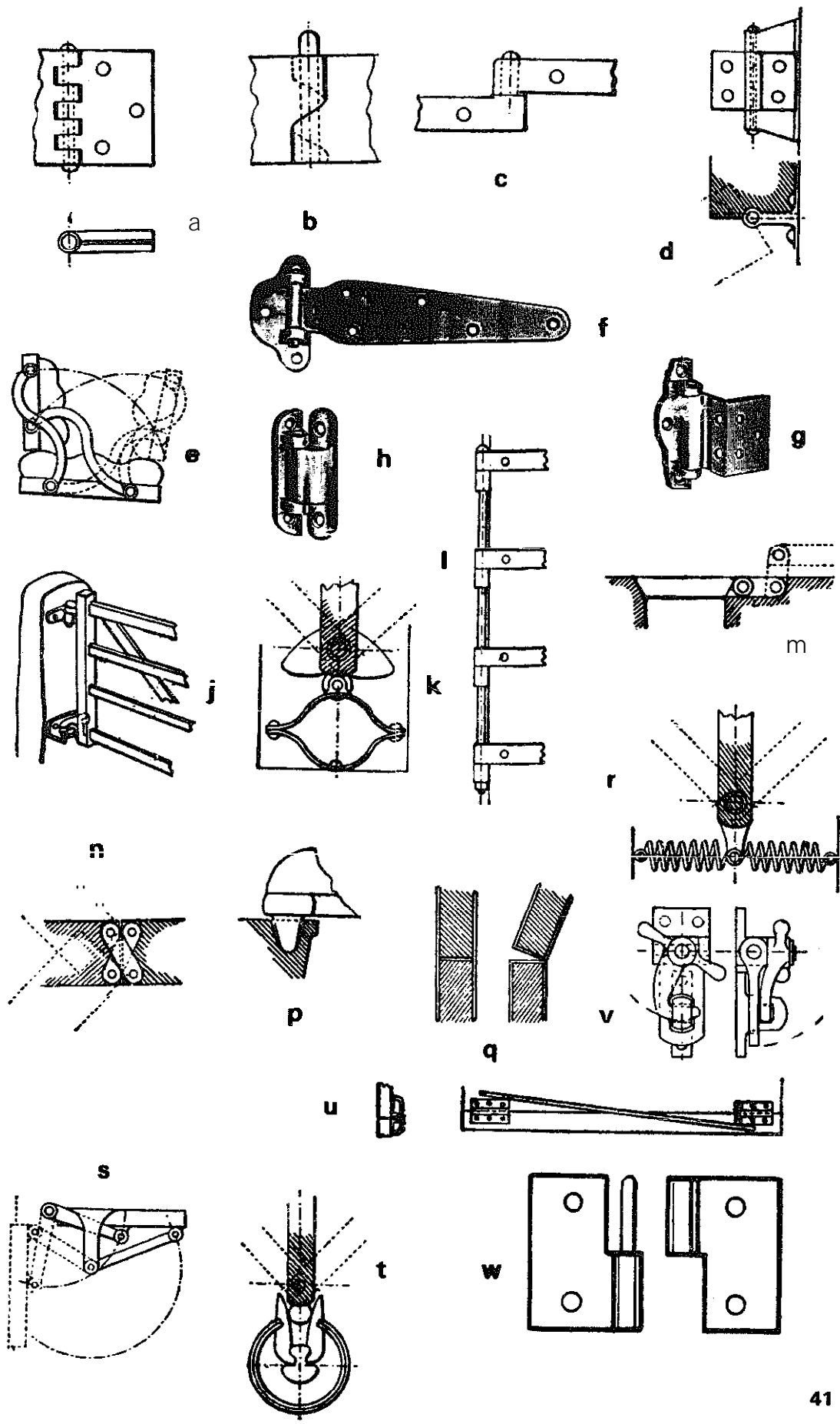

**A-Machine Elements**

**16-LEVERS.** Rigid pieces that transmit or modify forces or motions, when forces are applied at two points and it turns about a third.

**a-Plain** lever, with bosses for rod attachment. This lever is called first-class lever.

**b-First-class** lever. Fulcrum between force and weight.

**c-Second-class** lever. Weight between fulcrum and force.

**d-Third-class** lever. Force between fulcrum and weight.

**e-Bell crank.**

**f-T or double crank** lever.

**g-Lever** formed from plates and spacers.

**h,j,k-Brake release handles.**

**l-Double hand** lever.

**m-Slotted valve** lever.

**n-Wrist plate or t-lever.**

**p-Equalizing** lever for brake applications etc.

**q-Double lever** handle for pumping of old time fire pumps.

**r-Straight second-class** lever.

**s-Foot treadle frame.**

**t-Equalizing** levers for variable movements and springs.

**u-Lever and rack lifting** device.

**v-Balance weight** lever.

**w-Starting** lever with spring catch.

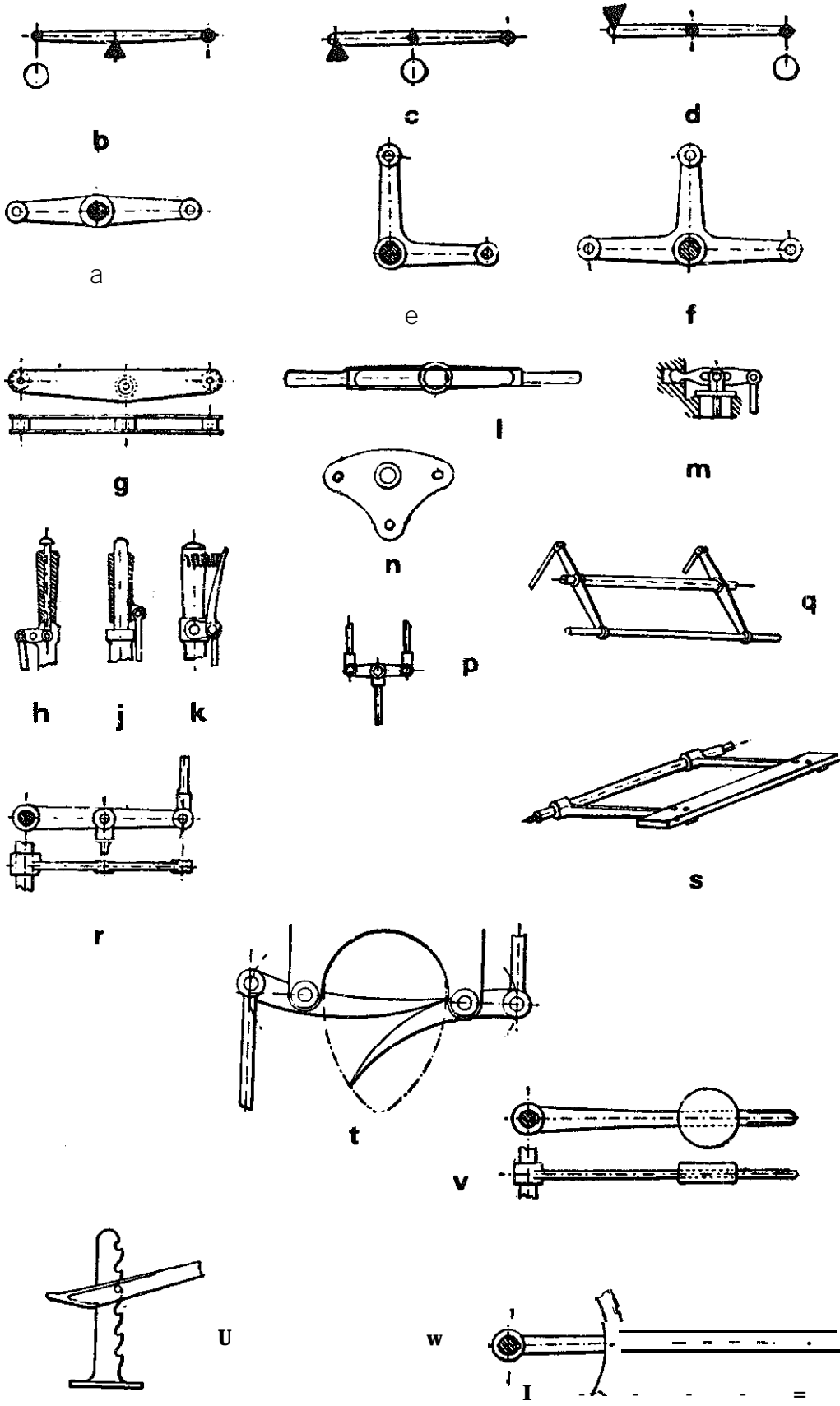

**A-Machine Elements**

**16-LEVERS (Cont)**

**x-Handlever** with adjustable length.

**y-Starting** lever with catch, hooked into holes in sector plate.

**z--Foot** lever.

**aa-Spherical washer**, nut and, lever for pull rod.

**ab-Spring** actuated lever stops in two positions only.

**ac-Two** levers connected through ball joint. Permits multi-directional motion.

**ad-Lever** with **universal motion**.

**ae-Rope-Twist** bar.

**af-Compound-lever** cutting pliers. Makes use of toggle joint principle.

**ag-Lever and ratchet** device for cash register.

**ah-lever and ratchet** device for cash register.

**aj-Lever action** applied to a typewriter roller.

**ak-Toggle joint** lever press or punch. Used in old printing or stamp presses.



LEVERS

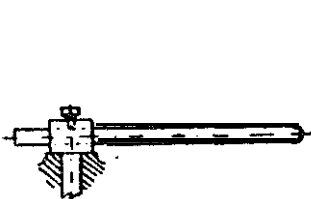

x

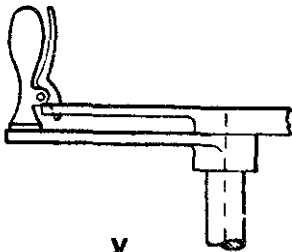

y

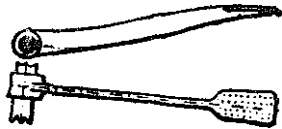

z

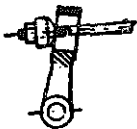

aa

ab

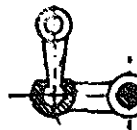
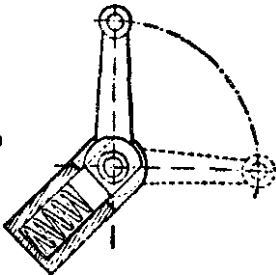

ac

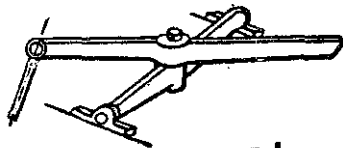

ad

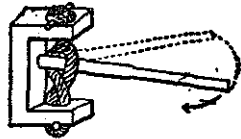

ae



af

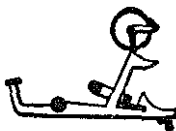

ag

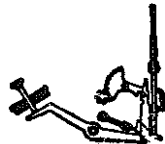

ah

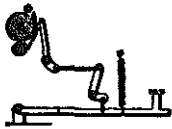

aj



ak

**A—Machine Elements**

**17—LINKS AND CONNECTING RODS**

**a-Link** without adjustment.

**b--Link** like “a” with raised bosses for facing and wear.

**c-Adjustable link.** Turnbuckle type arrangement. Locknuts should be added to prevent coupling from working loose.

**d-Solid rod end,** split with screw bolt tightening arrangement.

**e-Connecting rod head.** Split halves held together by through bolts.

**f-Forked end-rod.**

**g-Solid end** for connecting rod. Capstan screw adjusts brasses.

**h-Straphead** connecting rod with threaded cotter.

**j-Marine connecting** rod end with brass cap.

**k-Forked end** with cap.

**l-Rod end** with hinged strap and bolt.

**m-Rod end** with side strap.

**n-Solid end-rod.** Brasses are slipped in sideways, and locked with cotter and set screw.

**p-Exploded** view of connecting rod and oil slinger (3), crankshaft (5), piston, rings and pin assembly (2).

**q-Covered solid end** for crank pins with screw adjustments for the bearings

LINKS & CONNECTING RODS

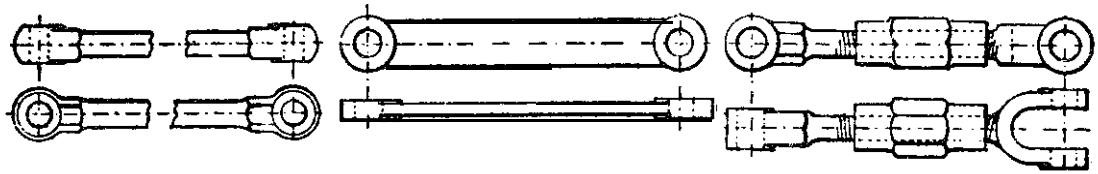

a

b

c

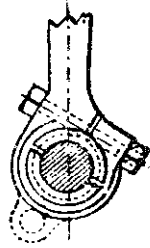

d

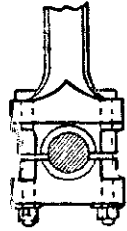

e

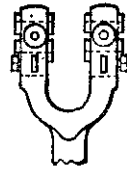

f

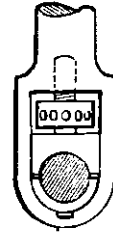

g

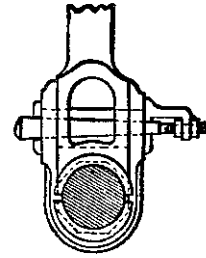

h

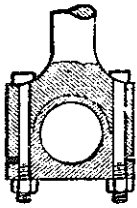

j

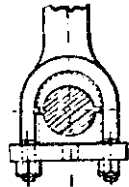

k

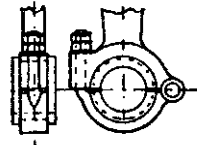

l

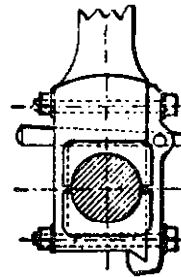

m

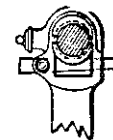

n

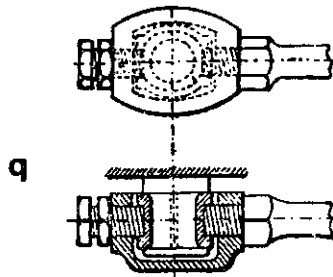

q

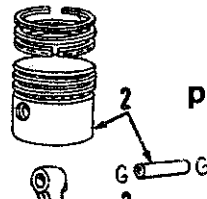

p

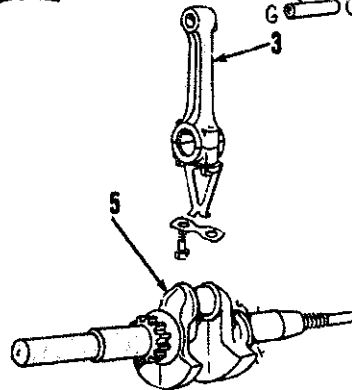

5

## A-Machine Elements

### 1&KEYS, COTTERS, PINS AND SPLINES.

**a-Plain square** key. Square cross section, (plain parallel key).

**b-Plain taper** key. Taper 1/8 in. per 12 in.

**c-Gib-head taper** key. Taper 1/8 in. per 12 in. Used where key cannot be driven out from small side.

**d-Woodruff** key. Used mostly for machine tools.

**e-Saddle** key, for light work only. Shaft not modified to hold key. Might turn under shock and damage shaft.

**f-Flat** key. Flat surface machined onto shaft. For light loads, but heavier than "e".

**g-Sunk** key for heavy work.

**h&Double keying** of shafts. For very heavy loads.

**k-Typical feather** key arrangement. Hub can slide axially.

**I-Round** key, Pin is cylindrical or tapered.

**m-Round** taper pin key

**n,p-Tapered** pin key,

q-Boss for strengthening housing.

**r-Hub staked** to shaft.,

**s-Cotter.** A cotter is a form of a key. Cotter (AC), forces straps (EF) and (GH) to move as per dotted line.

**t-Spline** act like multiple feather keys and are standardized for 4, 6 and 10 and 16 splines. There are parallel side splines and involute splines.

**u-Cotter held by screw.**

v-Use of set screw with cotter.

**w-Gib** combined with cotter.

**x-Two gibs** with cotter. Only one is tapered.

**y-Split** pin. After assemble, split end is forced apart.

**z-Cotter** pin. Used with threaded members as a positive locking device. After assemble ends are forced apart.

**aa-Typical cotter joint.**

# KEYS, COTTERS, PINS & SPLINES

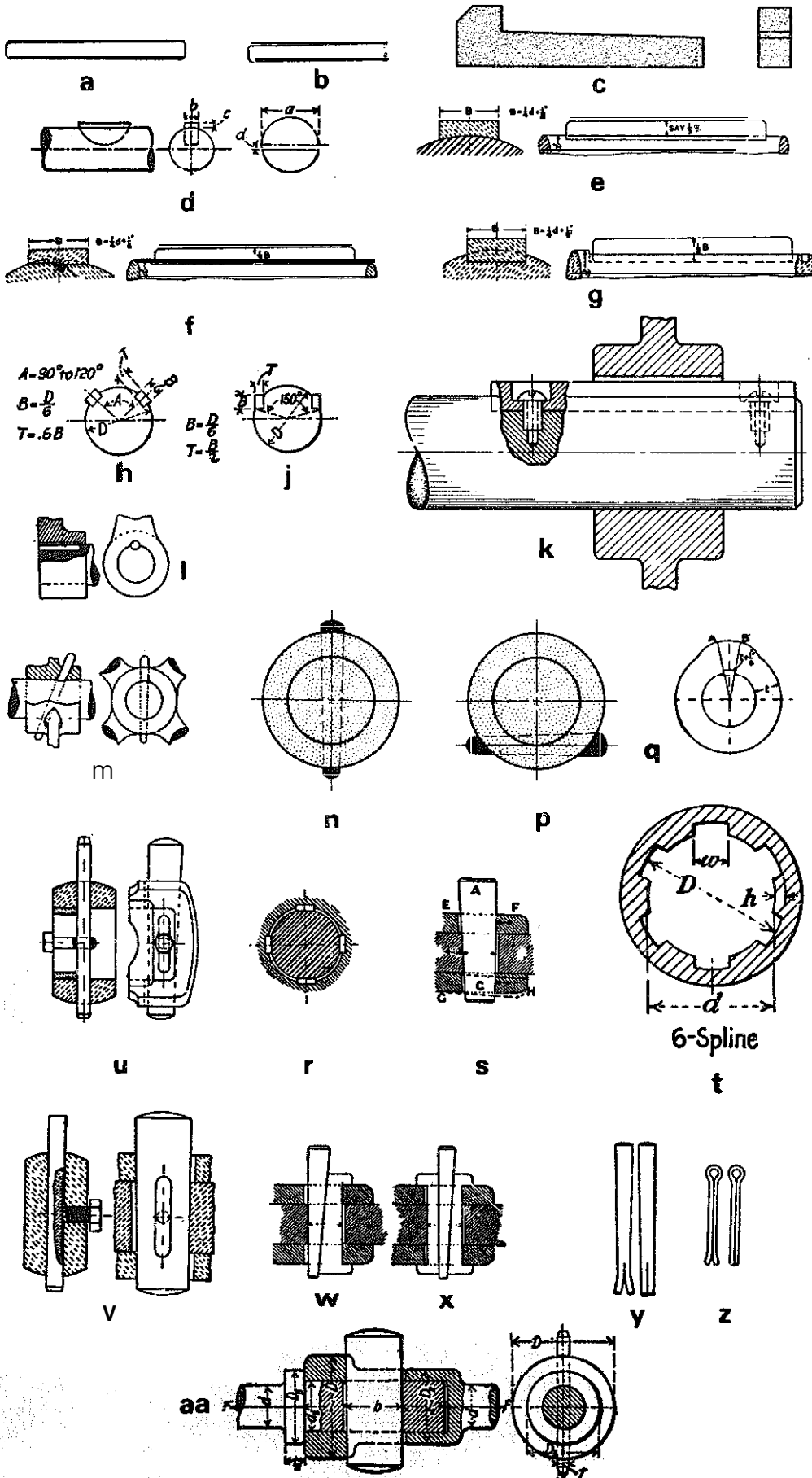

**A-Machine Elements**

19—GASKETS, SEALS AND PACKINGS. Gaskets are compression-type static seals. Usually gaskets are considered special packings. Seals are used between surfaces having relative motion. They prevent entrance of contaminants and loss of oil. If zero leak is required, a packing must be used.

**a,b,c,d,-Use of gaskets in bolted flanges.**

**e-Another type of gasket installation.**

**f-o-ring used as seal.**

**g-Application:** rubber – incompressible. Under pressure it flows laterally.

**h-Application:** cork – compressible. No lateral clearance required.

**j-Press-fitted cork seal.**

**k-Cork seal mounted with removable plate.**

**l-Grooved shaft labyrinth seal.**

**m-Typical felt seal.**

**n,p-Labyrinth with oil slinger.**

**q-Rubbing double-seal.**

**r-Non-rubbing double seal.** Two types of labyrinth seals combined.

**s,t,u-Metal gaskets.**

**v,w,x,y-Diaphragms as seals.**

**z-Double seal.** Sliding action maintained by garter spring.

**aa,ab-Gasket applications.**

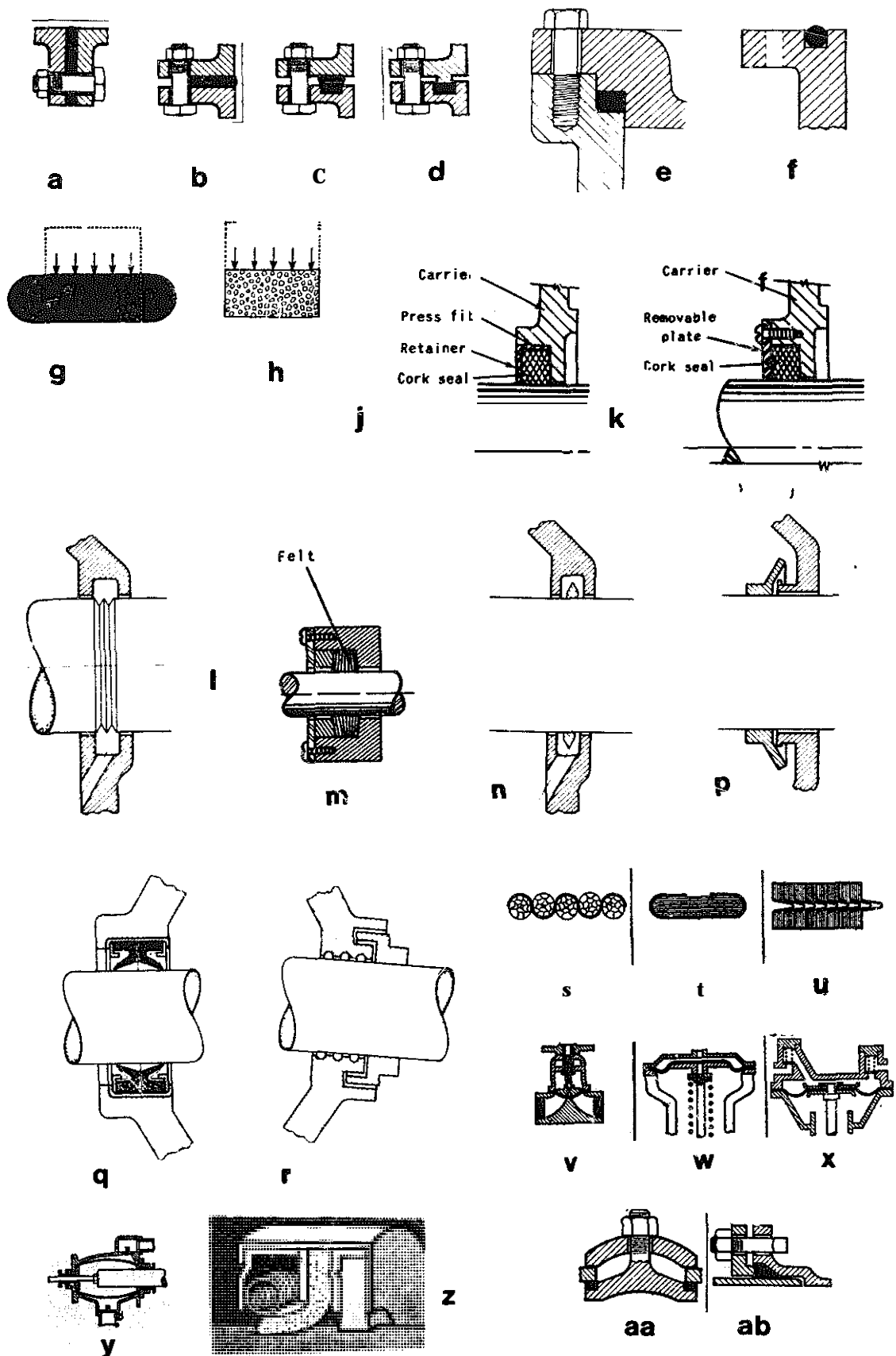

**A-Machine Elements**

**19—GASKETS, SEALS AND PACKINGS (Cont)**

**ac-Piston rings,split**

**ad-Split rings** tightened by gland.

**ae-Cups** used as seals.

**r&Labyrinth** packing.

**ag-Square rod plunger** packing with end rings.

**ah- Nested V-packings** are superior to “ag”.

**aj-Conical** packing.

**ak-Floating metal ring** packing. Made up from radial or tangential segments. They are assembled in pairs and held together by garter springs.

**al-Packing** for small plunger pump.

**am-V-leather** packing, before and after application of pressure.

**an-V-ring type hydraulic** packing.

**aq-Condenser tube-sheet ferrule.**

**ar-Gasket** used for “boltless” autoclave doors.

**as-pump** valve. Valve disc is a specialized gasket.

**at-Valve seat** of rubber.

**au,av,aw,ax—Various sliding contact** packings.



GASKETS, SEALS & PACKINGS

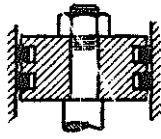

ac

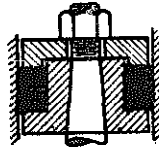

ad

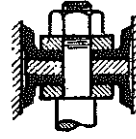

ae



af

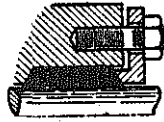

ag

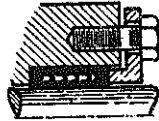

ah

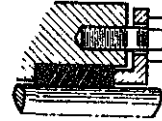

aj

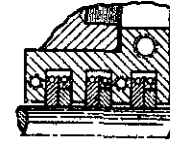

ak

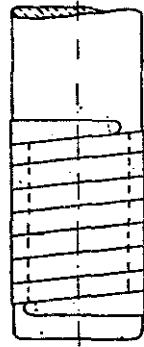

al



am



an



aq



ar

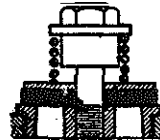

as



at



ax



aw

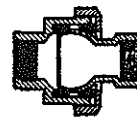

av



au

**A-Machine Elements**

**20--LUBRICATION**—The art of reducing frictional resistance occurring at the surface of two solids, forced to slide over each other. Oils and greases are the most common lubricants. Emulsions of oil and water and solids may also be lubricants.

**a-Oil-pressure** distribution around the circumference of sleeve bearing.

**b-Axial** pressure distribution. One oil hole supplies bearing.

**c-Axial distribution** with circumferential groove in bearing.

**d-Fluid** lubrication of collar bearing.

e-Lubrication of **pivot**.

**f-Needle method of fluid** lubrication.

**g-Syphon method** of lubrication.

**h-Pad method** of lubrication.

**j-Bath method** of lubrication.

**k-Ring method** of fluid lubrication.

**l-Oil cup** lubrication using wick feed.

**m-Sight gravity-feed oiler** with needle valve shut-off and breather tube.

**n-Gits wick-feed multiple** oiler. Has flushing features.

**p-Lubrication fitting** for grease gun. (Alemite Div., Stewart-Warner Corp.)

**q-Oil cup** for gravity feed. Shown with screwed on cap.

LUBRICATION

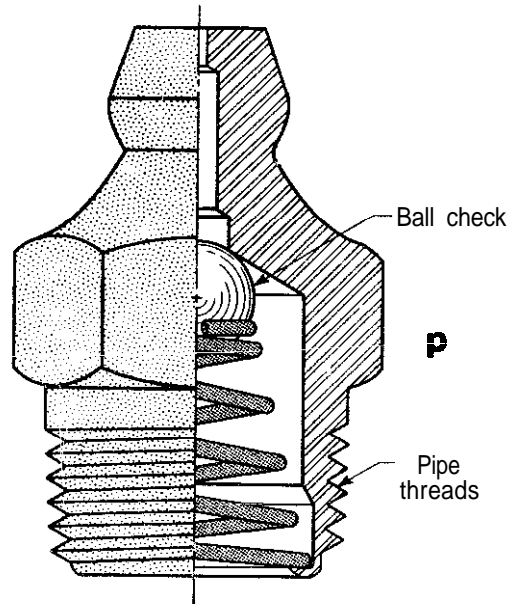
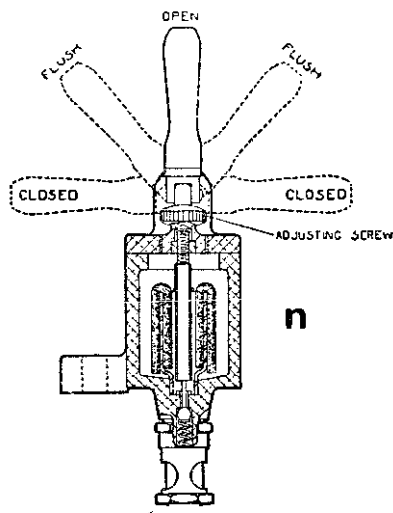
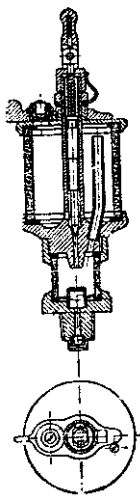
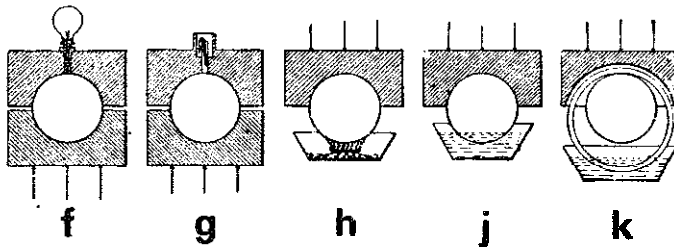
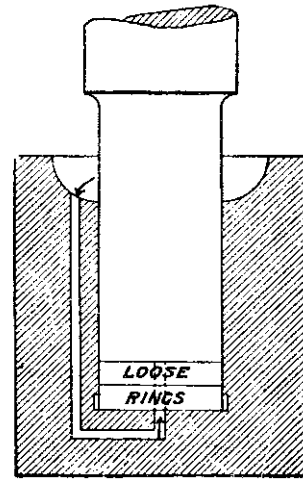
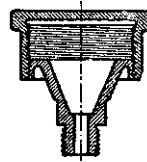
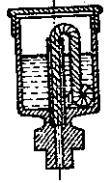
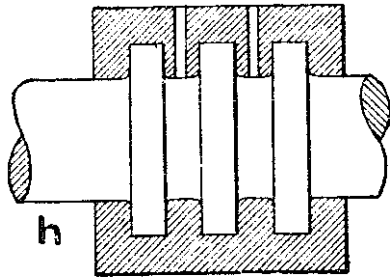
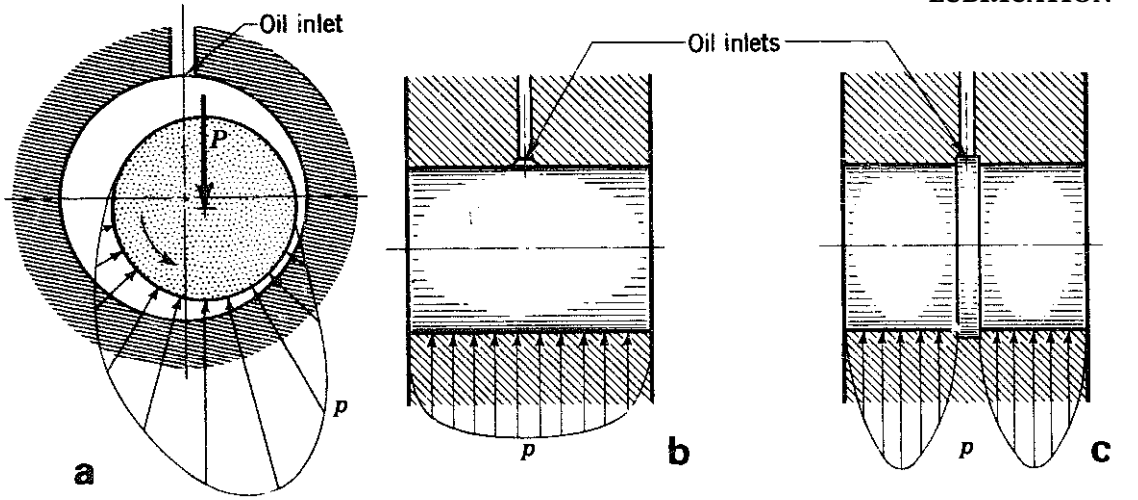

**A-Machine Elements**

20-LUBRICATION (Cont.)

**r-Force feed** lubrication. Oil supply pump supplies filtered oil to bearing under pressure.

**s-Lubricator.** Atomizes oil into mist by means of compressed air. Oil inlet (1), reservoir (2), air regulator (5), passage for low air pressure (7), oil flow regulator (8), venturi tube (9), strainer (10), baffle (11), supply line to bearings etc. (12). (Alemite Corp.)

**t-Jet** lubrication. Jets directed between cage and inner race of unloaded side of bearing.

**u-Cross feed** lubrication. Note flow of oil through bearing.

**v--Puddling** lubrication. Oil does not flow through bearing.

**w-Oil mist** lubrication.

**x-Wick** lubrication.

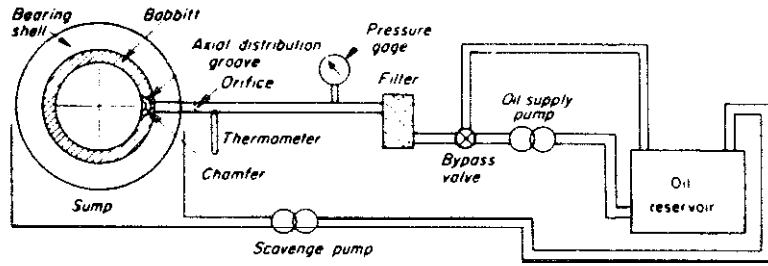

r

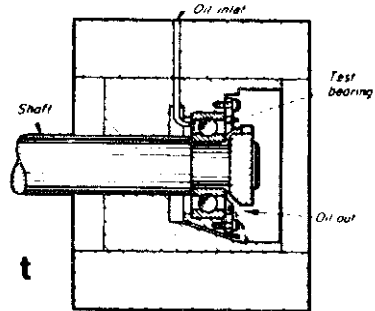
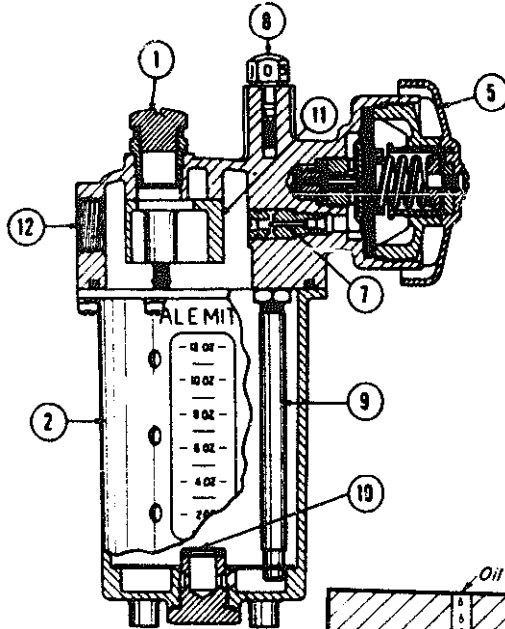

t

s

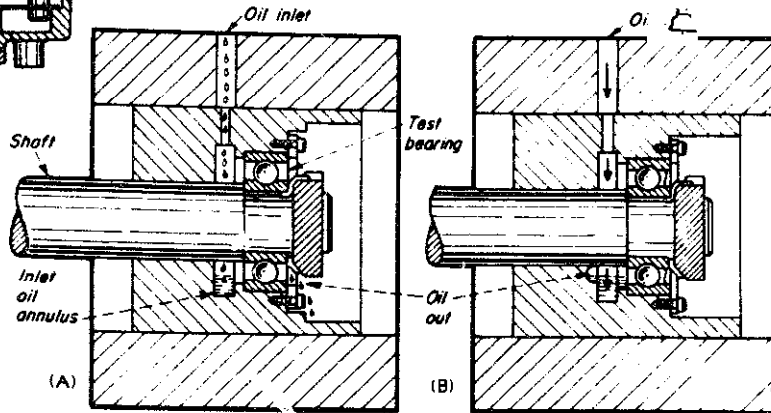

u

v

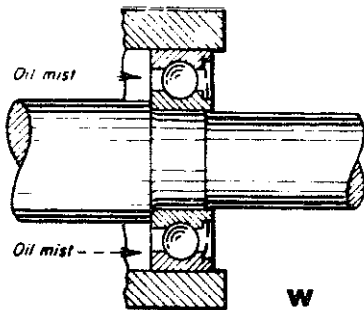

w

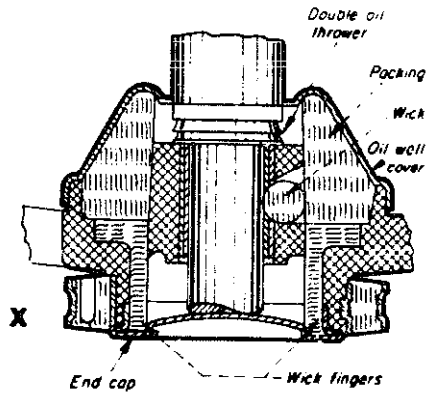

x

**B-Gearing**

**l-TOOTHED GEARING.** Gears are toothed wheels which insure positive means of transmitting rotation.

**a-Spur** gears; parallel axis; external contact; constant speed ratio.

**b-Internal spur** gear; parallel axis; internal contact.

**c-Spur** gears; parallel axis; rack and pinion.

**d-Involute helical** gears on parallel shaft.

**e-Double helical** gear. These are used because the axial thrust forces are balanced.

**f-Continuous-tooth herring bone** gear. Axial thrust forces balanced.

**g-Spur** gear engages pin-wheel.

**h-Bevel** gears; intersecting axes. Mitre bevel.

**j-Spiral bevel** gears; intersecting axes.

**k-Bevel** gears; intersecting axes; crown bevel.

**l-Helical** gears meshed with axes at  $90^\circ$  angle.

**m-Zerol bevel** gear. A spiral bevel gear with zero spiral angle. Gives larger contact ratio and more gradual contact during engagement of teeth.

**n-Worm and worm** gear; non-intersecting, non-parallel axes. **The** worm shown is cylindrical.

**p-Double enveloping** worm (hourglass worm) and worm gear.

**q-Hypoid gear;** non-intersecting and non-parallel axes.

# TOOTHED GEARING

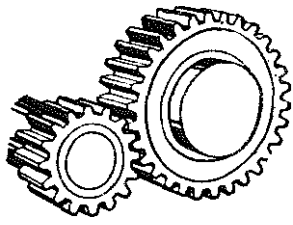

a

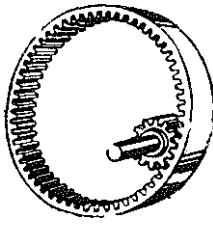

b

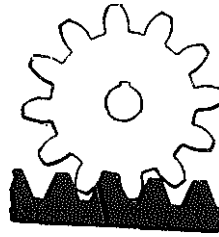

c

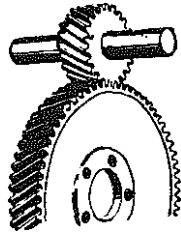

d

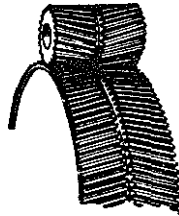

e

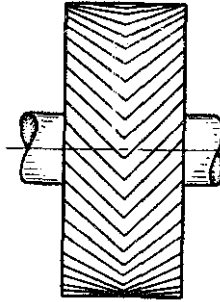

f

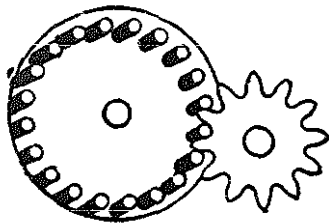

g

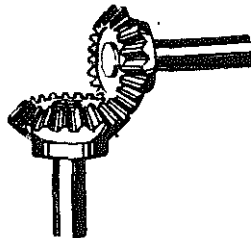

h

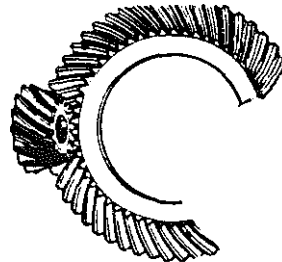

j

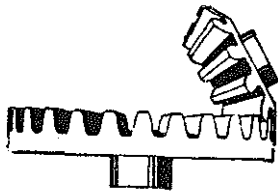

k

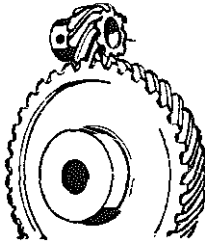

l

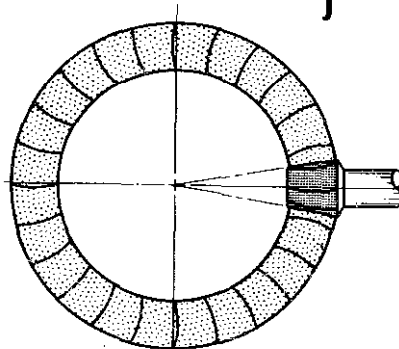

m

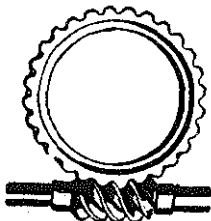

n

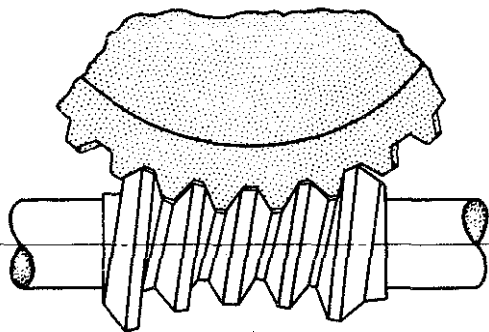

p

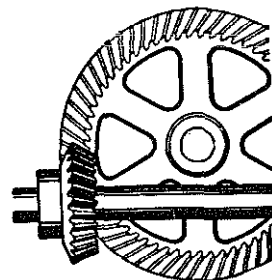

q

## **B-Gearing**

### **I-TOOTHED GEARING (Cont)**

**r-Spur gear** with helical teeth.

**s-Spur pinion and face gear.** Intersecting or skew shafts.

**t&Tapered** gears; intersecting or skew shafts.

**u-Epicyclic train;** Gear (C) is fixed and arm (D) moves around its axis at (A). Gear (B) will rotate in opposite direction to gear (A). Gear (A) will rotate in the direction of arm (D) but with increased rotational speed. If gear (A) is fixed (B) and (C) will have unequal forward motions.

**v-Epicyclic gear train.**

**w-Change motion** gearing.

**x-Sun and planet crank motion.** Connecting arm determines gear centers. Wheel "A" revolves twice for one revolution of gear "B". First used by James Watt on his steam engine.

**y-Sun and planet winding** gear.

**z-Alternating motion** of driven shaft at right angles to driver shaft. Lever shifts double clutch to desired input.

**aa-Epicyclic bevel** gears, Arm "FG" is fastened to arm "AA". Differential motions of gears "D" and "C", loose on shaft "AA" will produce rotation of arm "FG" around shaft "AA". Or, by making arm loose on shaft "AA", differential motion of shaft and arm can be obtained.

**ab-Continuous shaft** motion from an alternating driving shaft.

**ac-High-speed epicyclic** gear train. Bevel gear "C" is the driver.

**ad-Automatic clutch** motion for reversing.

**ae-Ball wheel** with limited angular traverse, gearing into one or two pinions.

**af-Spur** gears with long teeth or star wheels. Used on roller mangles where the centers rise and fall.

**ag-Pin wheel** and pinion gear.

**ah-Variable speed square** gear.



TOOTHED GEARING

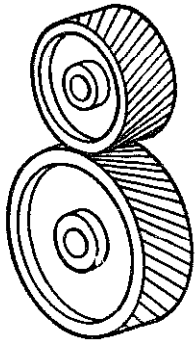

r

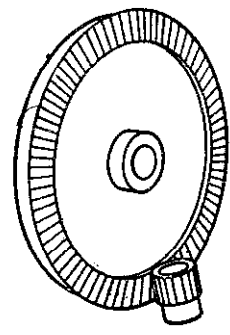

s

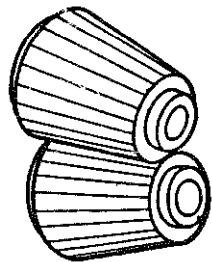

t

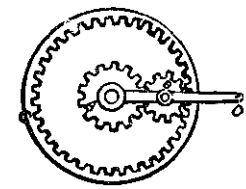

u

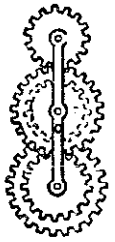

v

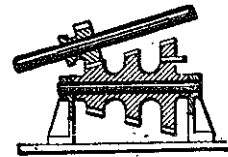

w

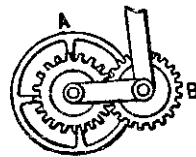

x

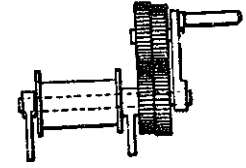

y

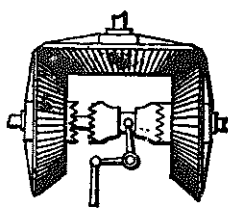

z

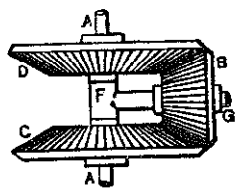

aa

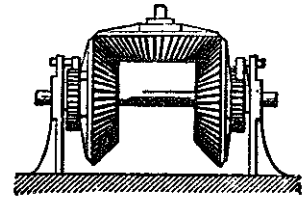

ab

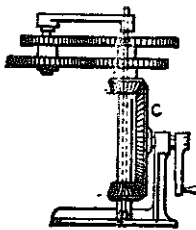

ac

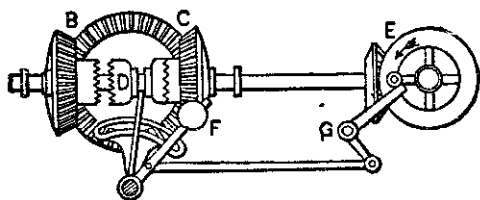

ad

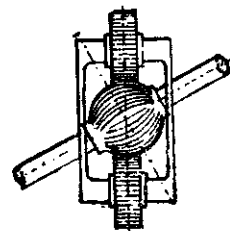

ae

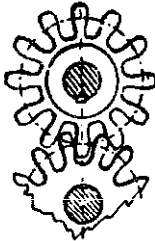

af

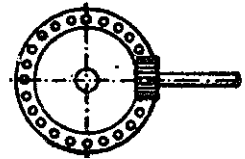

ag

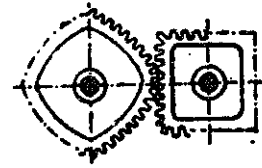

ah

**B-Gearing**

I-TOOTHED GEARING (Cont.)

**aj-Lantern wheel.**

**ak-Combined spur and bevel gear.**

**al-Irregular gear.** With each change of radius of driving gear, output speed changes.

**am-Scroll bevel gear.**

**an-Plain bevel gears** with shaft at obtuse angle.

**ap-Snail worm gear.**

**aq-Obsolete mechanism** of worm and crown gear. Provides low speed for two shafts in opposite directions.

**ar-Oval gears** linked together.

**as-Scroll ratchet.**

**at-Conical rotary gear,** as used on reaping machines.

**au-Hook tooth** and pin gear.

**av-Segment reversing gear.**

**aw-Bevel gear** with roller teeth in one wheel of the pair.

**ax-Planetary motion** as applied to an apple-pareing machine.

**ay-Uniform speed** of a sectional spur gear during part of a revolution.

**az-Variable sectional motion** from sector gears.

**ba-Scroll gearing** for increasing or decreasing the speed gradually during one revolution.

**bb-Miter intermittent gears.** The driver makes one revolution to one-quarter revolution of the driven gear.

**bc-Variable vibrating motion** for rod "A".

**bd-Differential spur gear.**

TOOTHED GEARING



aj

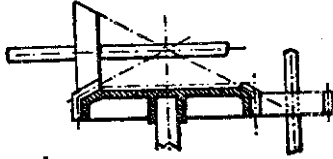

ak

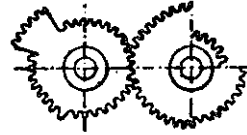

al

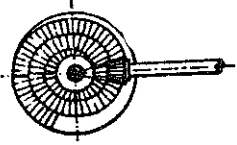

am

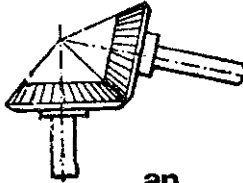

an

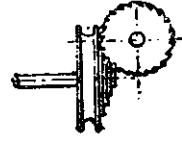

ap

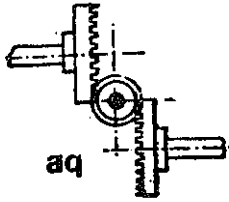

aq

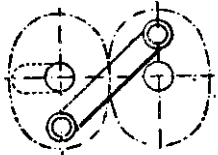

ar

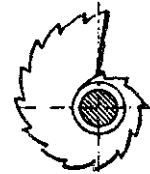

as

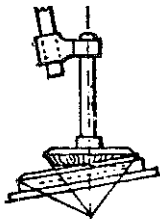

at

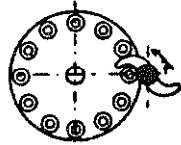

au

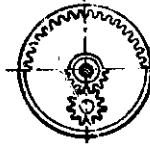

av

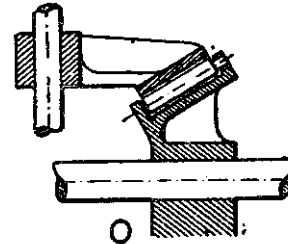

aw

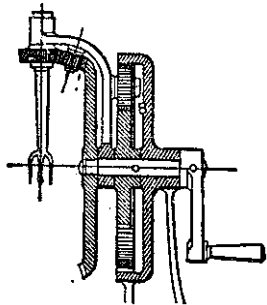

ax

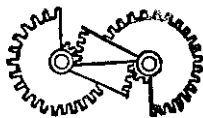

ay

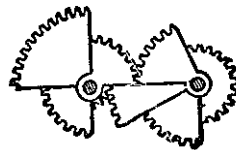

az

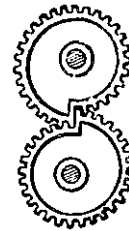

ba

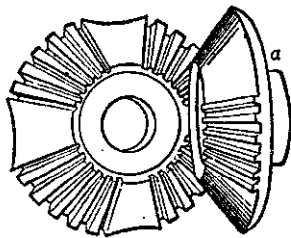

bb

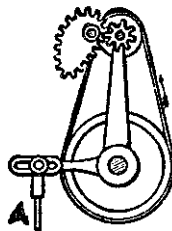

bc

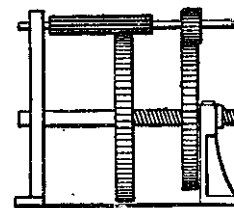

bd

## B-Gearing

### 1-TOOTHED GEARING (Cont)

**be-Three** unequal gears and two walking beams give variety of motions to connecting rod.

**bf-Hunting tooth** worm gear, used for planetary or clock motion. The double-worm gear may have one or several teeth more in one section than in the other. The motion of the worm advances one wheel in proportion to the difference in the number of teeth.

**bg-Elliptical spur** gear for variable speed. Often used on printing presses.

**bh-Irregular circular motion.**

**bj-Intermittent rotary** motion. Sector toothed wheel rotates continuously. Pins on wheel strike pinion lever.

**bk-Irregular vibratory motion** of arm "A" from rotary motion of pinion "B".

**bl-Stop roller motion** in wool-carding machine.

**bm-shows back** of "bl".

**bn-Spiral stop motion** gear. In addition to the stop, a variable motion is given to the driven wheel "B"; the dotted section at "G" shows the mesh of spur "K" of the stop wheel. "A" is the driving gear.

**bp-Intermittent motion** of spur gear in which dogs "G" and "F" form a part of driven gear "B"; this allows variable stop and/speed motion of the two gears; "A" is the driving gear.

**bq-Irregular circular** motion.

**br-Fast and slow-motion** spur gear. Also used for quick return motion on slide-crank motion.

**bs-Variable reciprocating motion** from a rotating spiral spur sector, meshed in racks inclined to the plane of motion. Pitch lines of rack are curved to fit pitch line of spiral sector. Pins on sector mesh with the stop jaws "J", "K", on the rack frame, alternately at each half revolution.

**bt-Differential epicycloidal gear.** Pinion and gear are loose on shaft and eccentric; one gear has one tooth more than the other.

**bu-Mangle machine** gear. Large gear toothed on both faces. Pinion moves from one side to other through open space.

**bv-Right and left hand worm gear** for operating drums or feed rolls.

**bw-Mangle wheel** is given **uniform** motion through major part of revolution and then a quick return.

**bx-Spiral hoop** gear. One revolution of disc moves gear by one tooth.

**by-Three-part** worm for operating three worm gears for a chuck.

**bz-Two toothed pinion** transmit; motion to a wheel having teeth alternating on each side.

TOOTHED GEARING

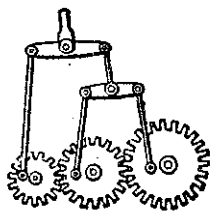

be

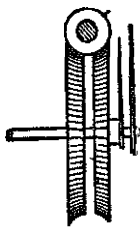

bf

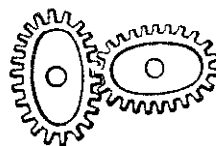

bg

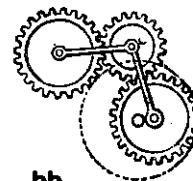

bh

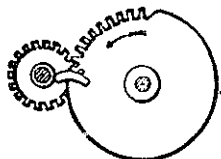

bj

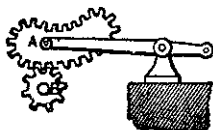

bk

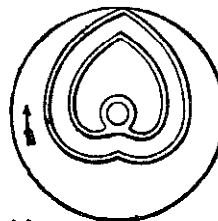

bl

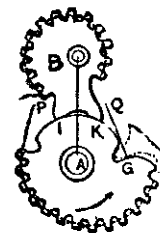

bn

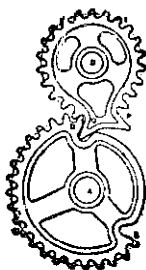

bp

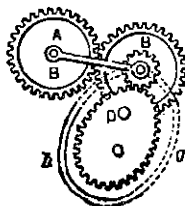

bq

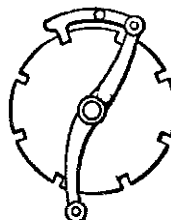

bm

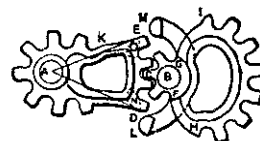

br

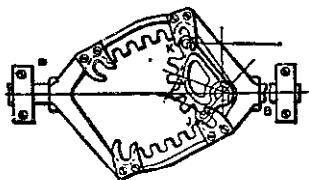

bs

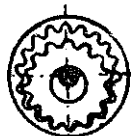

bt

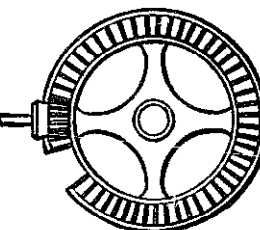
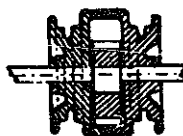

bu

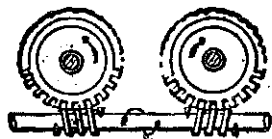

bv

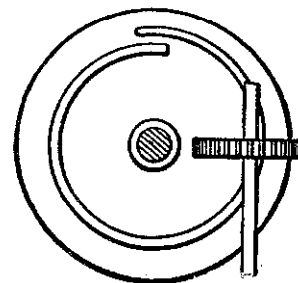
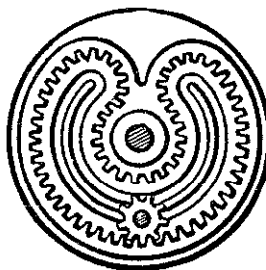

bx

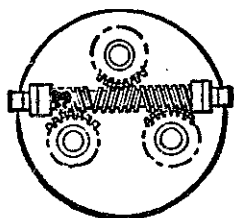

by

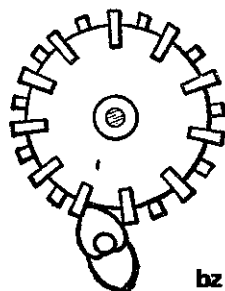

bz

**B-Gearing**

**2-RACK AND PINIONS**

**a -Rack and pinion** for obtaining reciprocating motion from circular or rectilinear motion.

**b-Pinions** in mesh produce reciprocating motion.

c-Circular rack and pinion gear.

**d-Pump movement.**

**e-Worm screw rack.**

**f-Rectilinear** vibrating motion.

g-Mangle **rack**; reciprocating motion of frame to which a pin tooth rack is attached, the pinion being guided by the shaft riding in a vertical slot, not shown.

h-Rack motion for air pumps. Racks are directly connected to the pistons of a single acting pump.

**j-Doubling** the length of a crank stroke.

**k-Disc** rotates at uniform speed. Rack has quick return motion.

l-Same as "k". Weight eliminates backlash.

**m-Vertical drop hammer** movement or impact rod.

**n-Mangle rack** with stationary pinion.

**p-Sector pinion** and double rack. Sector pinion rotates continuously producing rectilinear reciprocating motion.

**q-Rectilinear reciprocating motion** of bar with endless mangle rack. Pinion shaft, moving in slot guides pinion around end of rack.

**r-Mangle rack**, guided by rollers and driven by a lantern half pinion. Teeth in rack act as guides to insure tooth mesh at end of each stroke.

**s-Alternate rotation** of pinion from rectilinear motion of sector rack gear.

**t-Reciprocating double rack** alternately meshes with pinion. Cam running in smooth track of rack, lifts rack into and out of gear at end of each stroke.

**u-Crank substitute.** Two loose pinions with reverse ratchets attached to a shaft with pawls on the pinion ratchets. Each rack meshes with the reverse pinion for continuous motion of the shaft.

**v-Sawmill feed.**

**w-Reciprocating rectilinear motion** of a double rack, gives continuous motion to the central crank. Each stroke of rack engages one or the other sector alternately. Curved stop on center gear catches on the pins in the rack, engaging it with the opposite sector.

# RACK & PINIONS

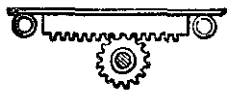

a

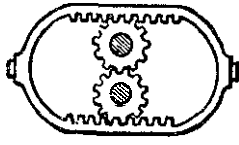

b



c

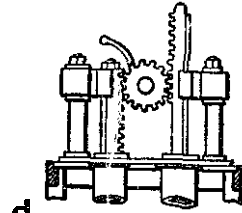

d



e

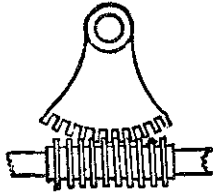

f



g

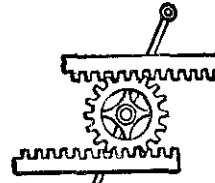

h

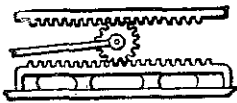

i

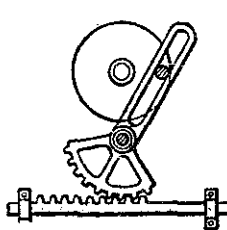

k

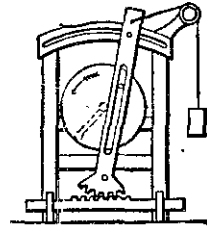

l

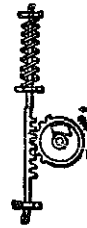

m

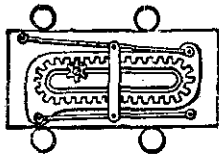

n

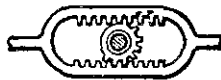

o

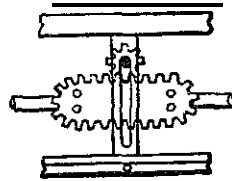

p

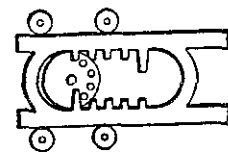

q



r

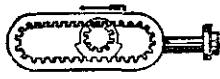

s



t

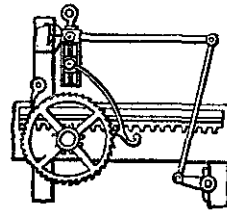

u

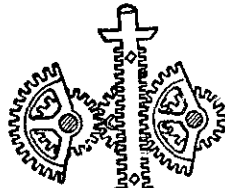

v

## B-Gearing

### 3-PAWLS AND RATCHETS

**a-Vibrating arm and pawl** acting on a ratchet wheel produce circular intermittent motion.

**b-Ratchet lift;** vibrating lever operates two hooked pawls on ratchet bar and lifts the bar; used in jacks and stump pullers.

**c-Double acting ratchet mechanism;** lever lifts pawls, one of which moves the ratchet on the upstroke, the other on the downstroke.

**d-Double acting ratchet mechanism.** Lever "a" vibrates with pawls "b" and "c," producing nearly steady rotary motion. Units with more pawls are possible.

e-Same as "d" except hook pawls.

**f-Intermittent circular** motion from a reciprocating rod.

**g-Continuous feed** of a ratchet by reciprocating motion of a rod having two pawls on the arms, pivoted by links to reciprocating rod.

**h-Pawl lift.**

**j-Intermittent circular** motion. Motion of planers.

**k-Intermittent motion** of ratchet by oscillation of a knuckle jointed tappet arm.

**l-Ratchet and lever pawl.** Ratchet drops by weight of the lever. Pulling of rope unhooks the pawl.

**m-Pawl wheel rotating** continuously moves ratchet wheel one tooth for every revolution. Check pawl prevents ratchet moving backwards.

**n-Oscillating motion** of sector into rotary motion by a straight and crossed belt running on two ratchet pulleys. Ratchets are keyed to shaft.

**p-Ratchet head** with spring pawls. Clockwise motion locks pawls into engagement and locks inner wheel. Counter clockwise motion forces pawls back.

**q-windlass grip pawl.** Oscillation of lever and attached rod make grip pawls grip windlass wheel.

**r-Continuous rotary** motion by check ratchet and oscillating beam.

**s-Intermittent rotary** motion. Disc and its spring rotate. Spring on disc lifts pawl spring and moves ratchet one tooth.

**t-Ratchet crown wheel** is given intermittent motion by reciprocating lever with pawl.

**u-Friction** pawls. Intermittent circular motion from oscillating motion of lever by friction pawls.

**V-Intermittent motion** of toothed wheel. Revolving pinion with single recessed tooth advances toothed wheel by one tooth for each revolution.

w-Same as "v." Teeth replaced by pins.



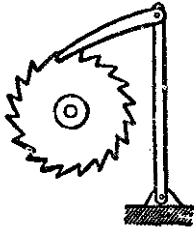

a

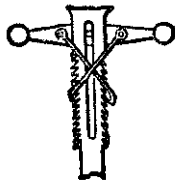

b

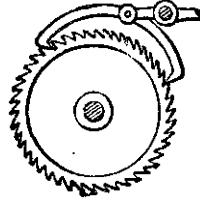

c

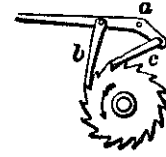

d

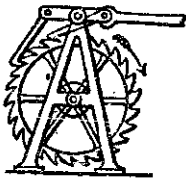

e

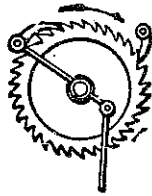

f

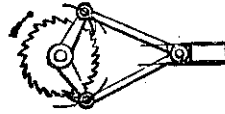

g

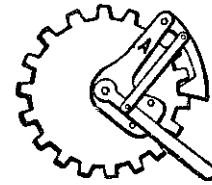

h

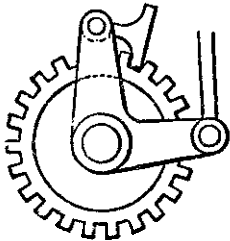

i

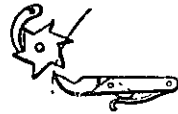

k

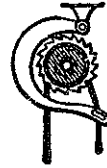

l

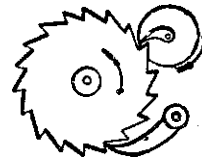

m

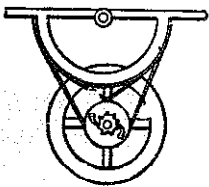

n

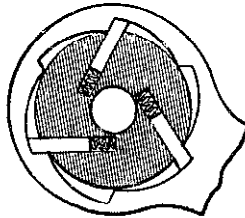

p

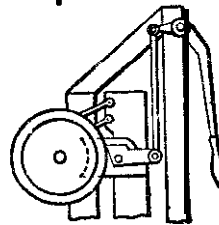

q

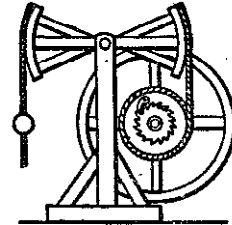

r

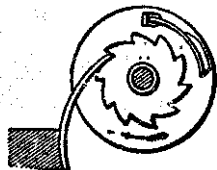

s

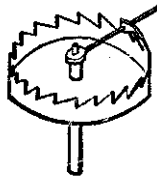

t

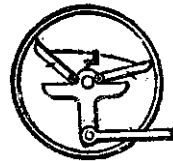

u

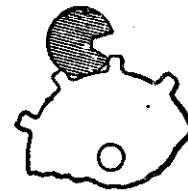

v

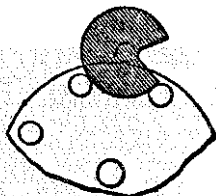

w

**B-Gearing****3-PAWLS AND RATCHETS (Cont)**

**x-Rack** and pawl lifting jack. The lower pawl is operated by a lever.

**y-Intermittent movement** of pin wheel by oscillating hooked arm.

**z-Roller stop and latch stop** for lantern wheel.

**aa-Intermittent rotary motion** for counters and meters. For one revolution of a toothed wheel, mating wheel advances one notch.

**ab-Same** as "aa"

**ac-Stops** for ratchet wheels: spring pawl, hook pawl and gravity pawl.

**ad-Revolution of segmental ring** causes intermittent motion of segmented wheel.

**ae-Rocking escapement.** Section teeth of wheel pass eye in the rocking cylinder at each half revolution.

**af-Ratchet bosses**

**ag-Ratchet brace** with slotted pawl.

**ah-Ratchet brace** without pawl; handle is hinged to socket arm. A tooth gears with the ratchet. It is thrown in and out of engagement by movement of the handle.

**aj-Ratchet brace.** Pawl is a fixed tooth and lever is slotted to allow it to clear teeth on back stroke.

**ak-Detail of cylinder escapement.** Shown: escape wheel tooth entering cylinder.

**al-locked intermittent motion.**

**an-Reverse** ratchets for continuous feed from an oscillating arm. Has two bevel gears and ratchets with pawls on opposite sides, causing a forward motion of the spindle at each stroke of the arm.

**an-Slot wheel and pin gear.**

**ap-Reciprocating circular motion** changed into intermittent circular motion.

**aq-Pendulum and double-ratchet wheel escapement.**

**ar-Pendulum** and ratchet escapement.

**as-V-pawl.** It operates through wedging of pawl into V-groove

**at-Rack and screw press.**

**au-Fixed pawl and star wheel.** To convey intermittent motion to a screw on a revolving disc for boring bars, slides etc.

**av-Gravity pawl** and ratchet wheel.

**aw-Pin wheel** rotates and lifts pawl out of engagement tooth on pin wheel advances gear one or two teeth.

**au-Rotary motion** from reciprocating motion of two racks meshing alternately with a gear wheel; racks are pinioned at "a", "a". The curved slots "b" guide the racks in and out of gear. Bell crank lever "c" and spring "d" serve to disengage the rack at the end of the upstroke.

PAWLS & RATCHETS

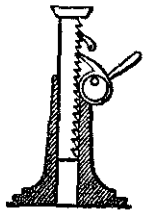

x

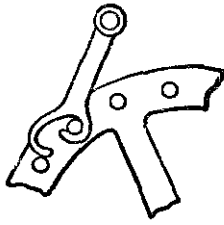

y

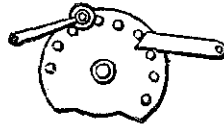

z

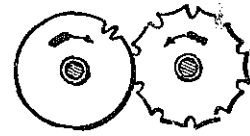

aa

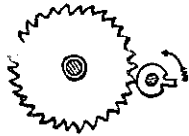

ab

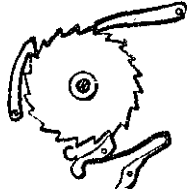

ac



ad

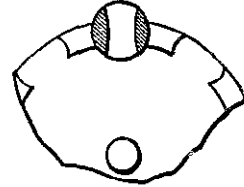

ae

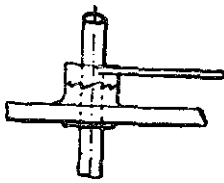

af

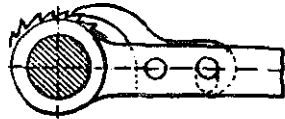

ag

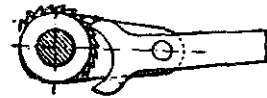

ah



aj



ak

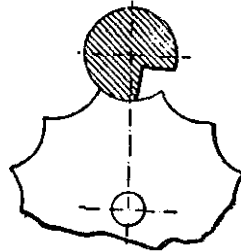

al

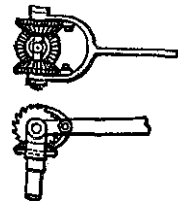

am

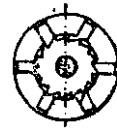

av

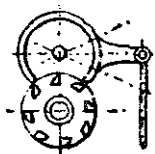

ap

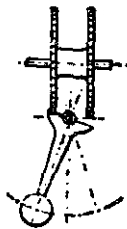

aq



ar



as

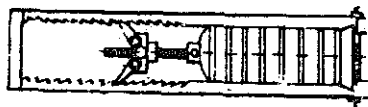

at

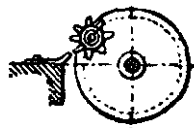

au

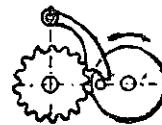

aw

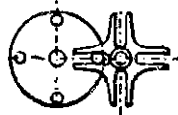

an

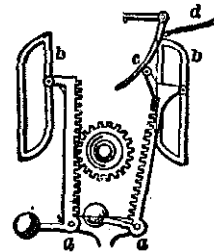

ax

## B-Gearing

**4-FRICTION GEARING**—Friction gears depend for their driving action upon friction between driving wheel and follower.

**a-Variable rotary motion** from a friction pulley traversing a concave drum.

**b-Variable motion** to right angled shaft by curved conic friction pulleys with intermediate swinging pulley. Used for light power.

**c-Friction bevel gears.**

**d-Variable speed** gear arrangement. Upper shaft drives; lower shaft is driven. Radius of frictional contact of wheels varies as they move closer or further apart.

**e-Wedge gearing** with spring grip adjustment.

**f-Friction gear** traversing motion.

**g-Wedge surface friction gearing.**

**h-Grooved spur friction gears.**

**j-Friction gear.** Pair of friction discs on parallel shafts with traverse pinion give a great range of speed.

**k-Friction gear.** "B" is a swivelling yoke with driving and friction pulley. Output speed depends on position of yoke.

**l-Friction gear,** variable speed. Pivoted swinging pulley transmits motion to in-line shafts. Speed depends on angle of tilt.

**m-Variable speed friction gearing.** Position of driving pinion determines output speed of shaft.

**n-Transmission of rotary motion** to an oblique shaft by rolling contact of drums with concave surfaces,

**p-Friction gearing.** Double faced friction pinion moves on line "A B" and is in contact between driving cone and driven cone. Speed determined by position of pinion.

**q-Plate friction clutch.**

**r-Variable drive** with V-belt. Space between discs can be varied by hand lever or screw motion.

**s-Variable friction cone drive.** Adjustable leather band forms gripping medium between cones.

**t-Friction drive** consisting of solid wheel and rubber-tired driving pinion. (Phonographs)

**u-Antifriction rolling contact.** Shaft runs in V between two rollers.

**v-Friction drive,** variable speed and reverse motion. Left lever changes direction of rotation; bottom lever the output speed.

# FRICTION GEARING

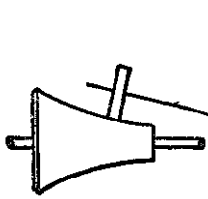

a

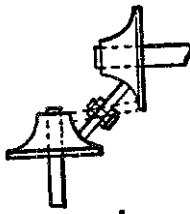

b

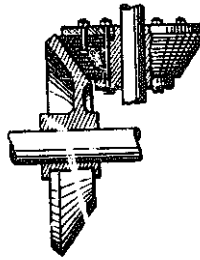

c

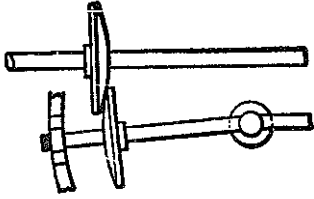

d

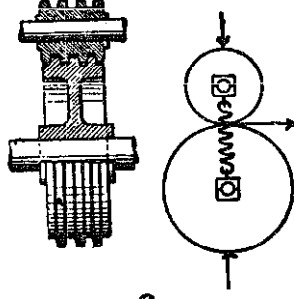

e

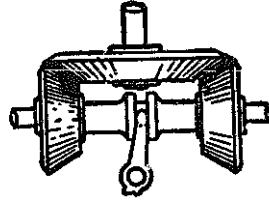

f

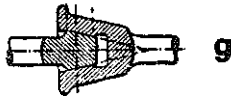

g

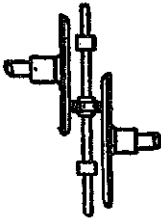

h

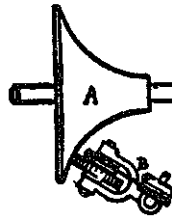

i

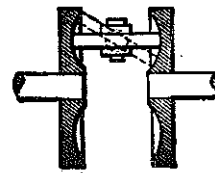

j

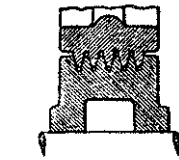

k

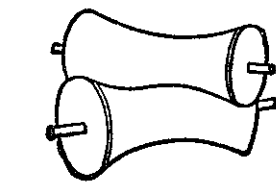

l

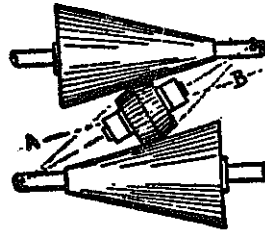

m

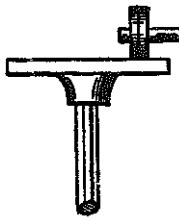

n

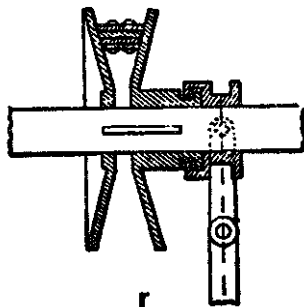

o

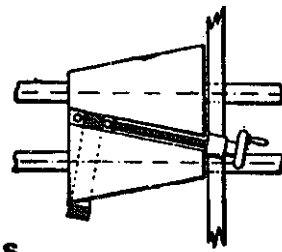

p

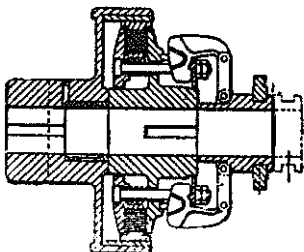

q

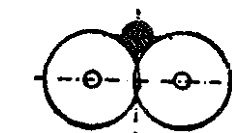

r

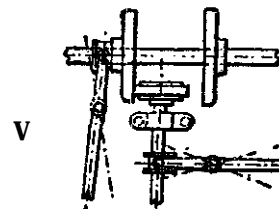

s

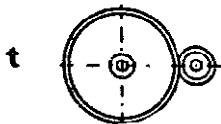

t

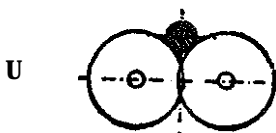

u

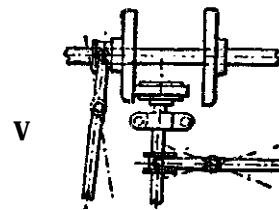

v

## B-Gearing

**S-EPICYCLIC GEARING** – also called planetary. One or more gears in train revolve about others.

**a-Single planetary** arrangement in which the planetary gear revolves within an internally stationary gear and around a central gear (sun gear). The planetary gear rotates on its axes.

**b--Compound planetary** arrangement. Here the planetary gear is a compound gear.

**c--Planetary** arrangement with four-armed spider.

**d-Planetary** arrangement. Frame=0, driver=1, follower=4.

Velocity ratio =  $\frac{2D_2D_4}{D_1(D_2-D_3)}$  is the ratio of the driver to the follower.

**e-Planetary** gear train for chain hoist. Frame=0, driver=1, follower=4.

Velocity ratio =  $1 + \frac{D_2D_0}{D_3D_1}$

**f-Planetary** gear train.

Velocity ratio =  $1 - \frac{D_2D_0}{D_3D_1}$

**g-Planetary** gear train. Frame=0, driver=1, follower=3.

Velocity ratio =  $1 + \frac{D_0}{D_1}$

**h-Section of automobile differential gear.**

**j-Epicyclic** train. If arm "A" makes 20 turns clockwise, and gear "B" 10 turns clockwise, gear "D" will make 30 turns clockwise, and gear "C" 13 1/2 revolutions about its own axis.

EPICYCLIC GEARING

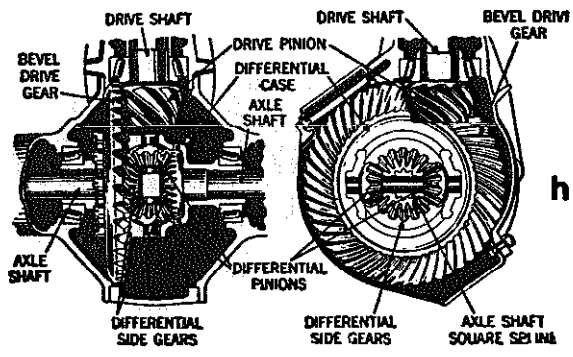
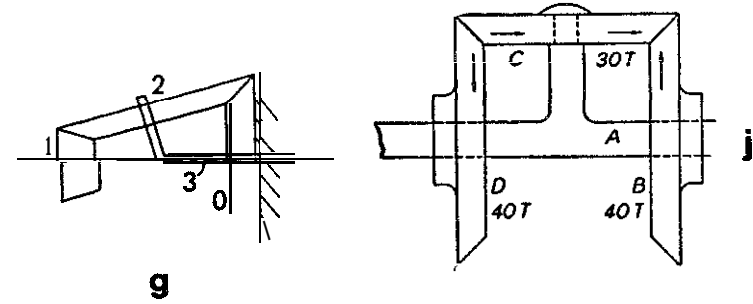
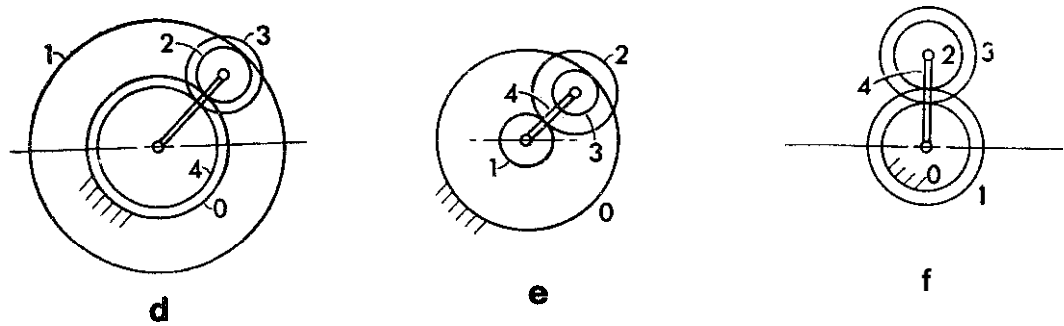
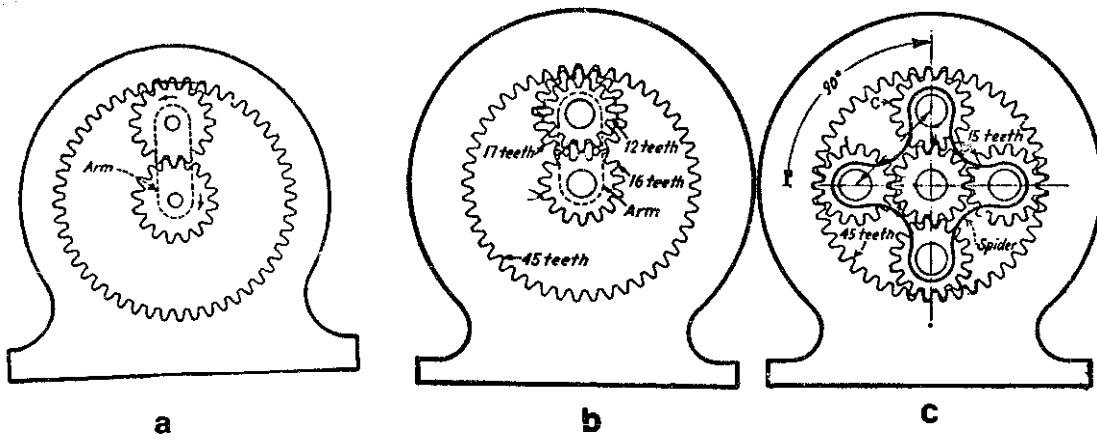

## C-Mechanical Transmissions

1—**WIRE ROPE** — In designating wire-rope construction, it is customary to state first, the number of strands; second, the number of wires in a strand; third, the kind of center or core whether fiber, hemp, wire strand or wire rope. When wire rope remains in a fixed position (such as in cables for suspension bridges) or where little bending is required, a wire core is desirable. For transmission of motion, flexibility over grooved pulleys is desirable and is secured by thinner wires and hemp or fiber cores.

6 X 7 haulage and guy rope. For use under severe operating conditions.

6 X 19 class wire rope, formerly called standard flexible hoisting rope.

8 X 19 class wire rope, formerly called extra flexible hoisting rope, has somewhat greater flexibility than 6 X 19 rope.

6 X 37 class wire rope, formerly called special flexible hoisting rope.

For high-speed use on cranes or where sheaves are small.

a-3 X 7; fiber center.

b-6 X 7; fiber center.

c-7 X 7; wire center.

d-6 x 8; hemp center.

e-6 X 13; hemp center; filler wire.

f-6 X 16; fiber center; filler wire.

g-7 X 19; wire-strand center.

h-6 x 19; fiber center; two stranding operations.

j-6 x 19; hemp center. (Seale)

k-6 x 37; fiber center; tiller wire.

l-6 X 4 1; wire-rope center.

m-18 X 7; nonpinning type hoisting rope.

n-6 X 19; flexible wire-rope center. (Seale)

o-6 X 19; hemp center. (Warrington)

p-6 X 19; hemp center; filler wire.

q-8 X 19; hemp center. (Seale)

r-8 X 19; fiber center; filler wire.

s-8 X 19; hemp center. (Warrington)

t-6 X 19; wire-rope center; filler wire.

u-6 X 22; wire-rope center; filler wire.

v-6 X 3 1; fiber center.

w-8 X 19; fiber center; two stranding operations.

x-6 X 12; one hemp center.

y-6 X 12; seven hemp centers.

z-6 X 37; wire-rope center. (Seale)

aa-6 X 37; fiber center; two stranding operations.

ab-6 X 37; hemp center; three stranding operations.

ac-6 X 24; seven hemp centers.

ad-6 X 42; seven hemp centers; most flexible; called "tiller" or "hand rope."

ae-3 X 37; wire center.

af-Typical wire-rope center.

ag-Typical hemp or fiber center.

ah-Typical strand center.

aj-Steel wires twisted into a single strand of nineteen wires.

ak-Steel wires twisted into a single strand of fifty-one wires.

al-Armored wire rope: 6 X 19; fiber center; sometimes wire center; used under severe hoisting conditions, such as dredging and heavy steam-shovel work.

am-Marline-covered rope; 5 X 19; hemp center; used for ships's rigging and hoisting service where moisture is encountered. (American Chain and Cable Co.)

an-Stone sawing strand; three wires twisted together.

ao,ap-Regular-lay (right and left) wire rope; wires in strands twisted together in one direction and strands twisted in opposite directions.

aq,ar-Lang-lay (right and left) wire rope; wires in strands and strands twisted in the same direction.



WIRE ROPE

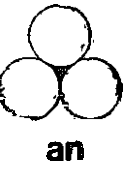
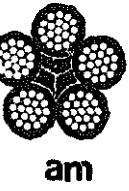
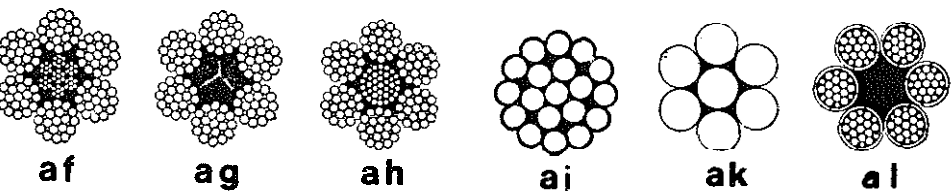
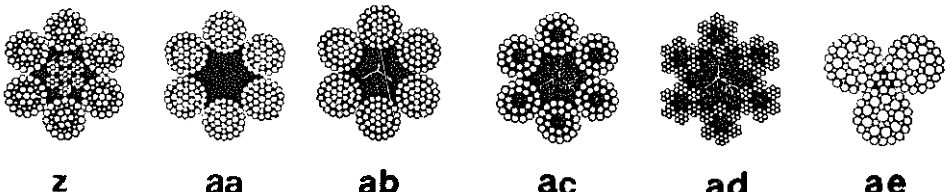
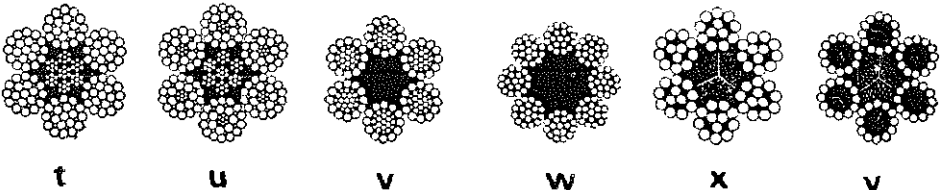
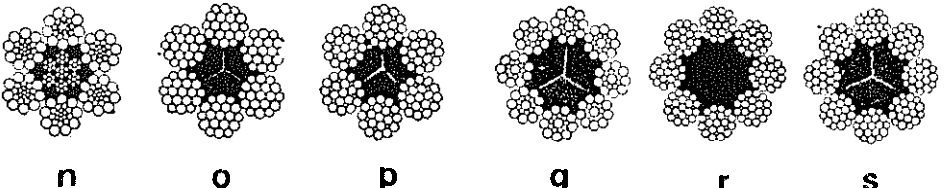
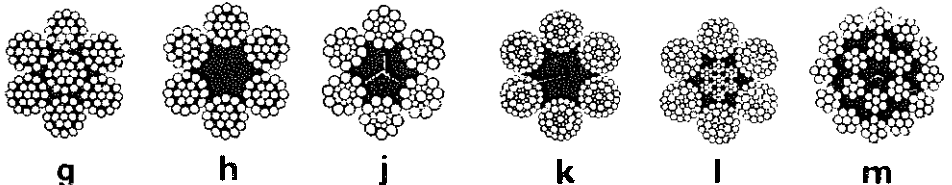
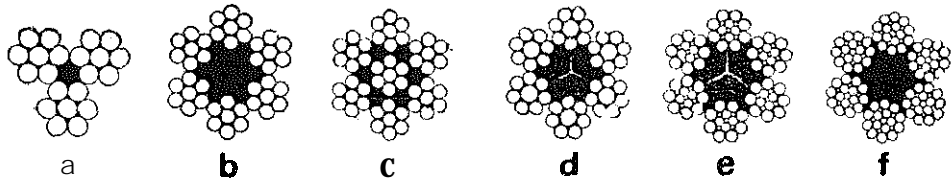

## C-Mechanical Transmissions

### Z-WIRE-ROPE PULLEYS

**a-Guide** pulley or support; the bottom of the groove fits the wire rope.

**b-Driving** pulley; the bottom of the groove is lined with a material softer than metal, generally leather, but wood, rubber, etc., are also used. Presently a polyurethane coating is preferred.

**c-Two-grooved lined pulley**

**d-Clip** pulley; the rim is divided into a series of toggles with pin joints at B and C causing the wire rope to be gripped with a force which varies with the tension of the rope (Fowler)

**e-Differential wire-rope** pulley; each groove is formed in a ring complete in itself; they are placed side by side with a combined clearance of  $1/32$  inch for six grooves; the rings adjust themselves automatically to all conditions of the load; the rope never slips in the groove, and the friction between rings and rim is sufficient for all purposes; a grease lubricator is shown at L: if ring slippage occurs, the flanges at F are tightened up; an elastic cushion C is placed between the flange and the pulley. (Walker)

**f-Mining** car connected to wire cable by a screw grip G, or by knotting a chain around the cable to engage a projecting bar C.

**g-Tramway** cable grip.

**h-Shackle** for wire rope.

**j-Single-rope lined sheave.**

**k-bolted steel line-grooved hoisting sheave.**

**I-Correct** arc for the bottom of the groove to give intimate contact.

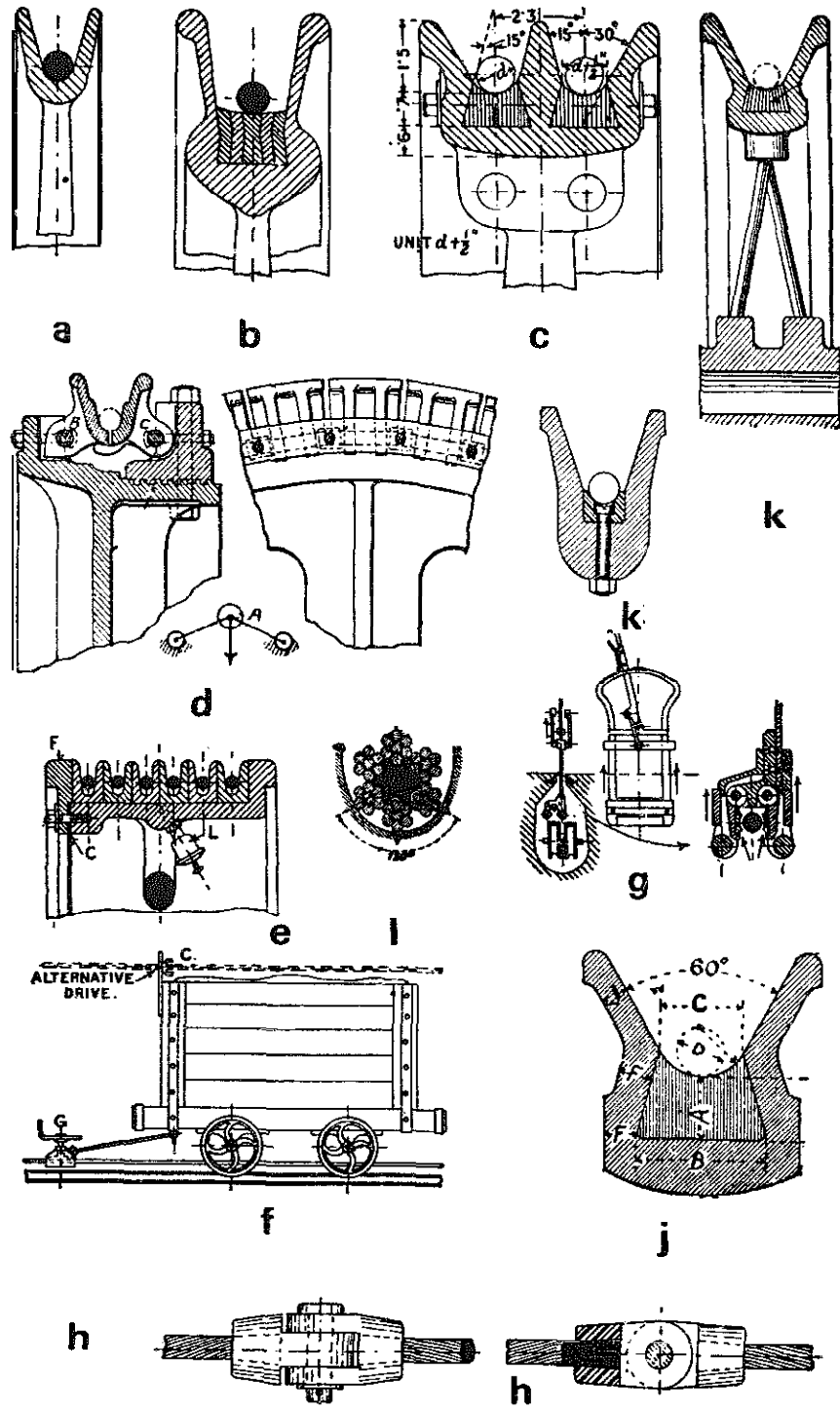

## C-Mechanical Transmissions

3-WIRE-ROPE TRANSMISSIONS-Formerly favored for long distance transmission of power; now used mainly for elevators, mine hoists, cranes, ski-lifts or other aerial conveyors, haulage devices and suspension bridges.

a-Transmission **without supporting** pulleys.

h-Transmission **with supporting** pulleys; driving side is at the bottom.

c-Transmission **with supporting pulleys**; driving side is at the top.

d-Transmission **over hilly ground**.

e-Transmission with **long-space intermediate pulleys**.

**f-Guide pulley.**

**g,h-Use of toothed gearing.**

**j-Mounted intermediate pulley.**

**k-Mounted pulley.**

**l-Angle-bar guide** for mounting rope.

m-Driving **friction drum** for low speeds.

**n-Tension producer** for low speeds.

**o-Rope-supporting** underground haulage.

p-Grooved driving and counter pulleys.

**q-Rope clips** and clamps (Bullivant).

**r-Shackles** for wire rope.

**s-Wire rope socket**, closed pattern.

# WIRE-ROPE TRANSMISSIONS

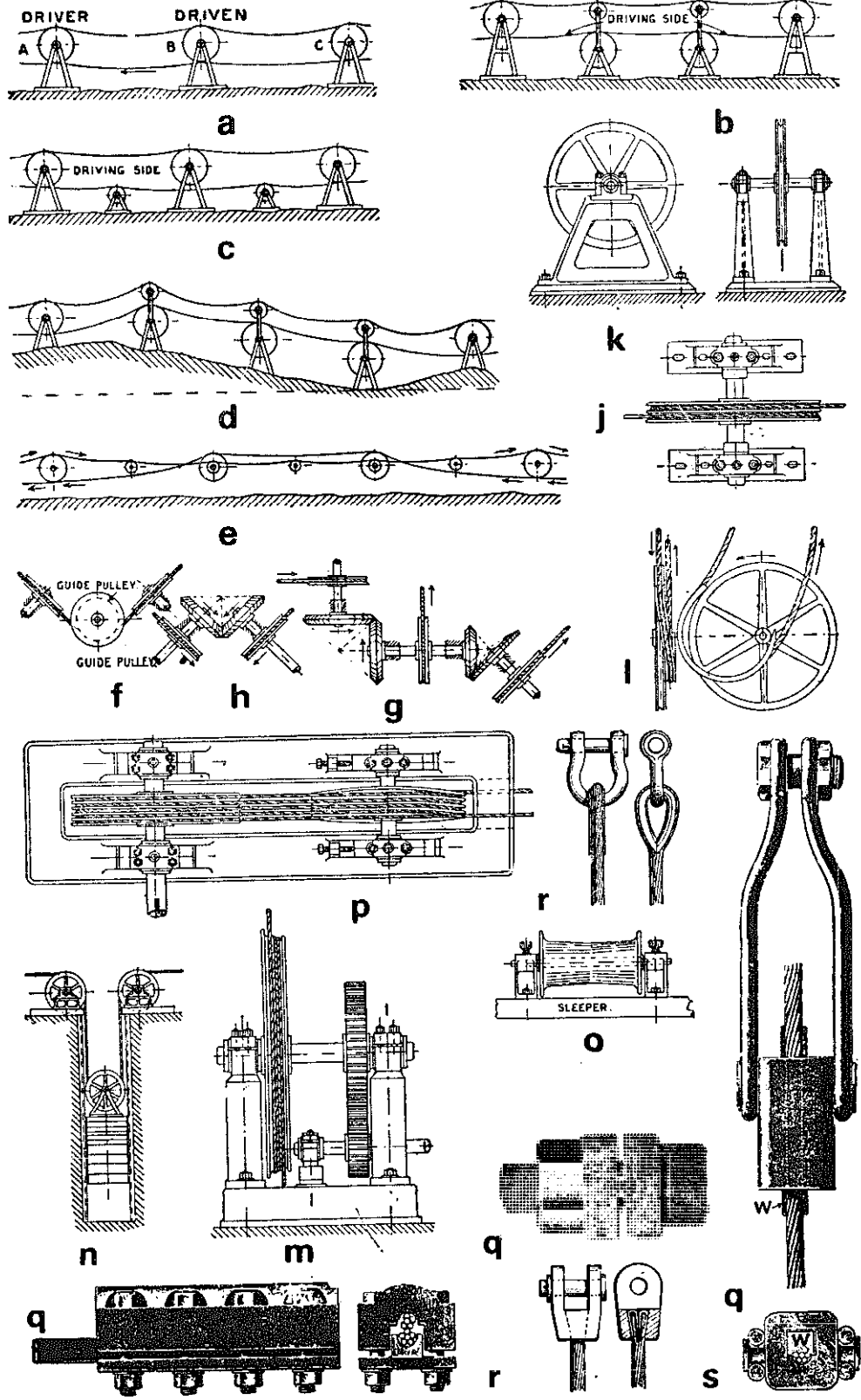

## C-Mechanical Transmissions

**J-TEXTILE ROPE TRANSMISSIONS**-Of the textile ropes, the most important ones are manila, hemp, cotton and jute. Of the synthetic fibers nylon and dacron ropes are the most used.

**a-Detail**-Textile rope drive. Form and proportion of pulley grooves; the unit diameter equals the diameter of the rope.

**b**-Rope drive with separate textile ropes (English system).

**c**-Rope **drive** with continuous rope (old American system).

**d-Pulley for hand** rope.

**e-Guide pulley**; the rope rests on the bottom of the groove.

**f-Canted** groove for oblique drive.

**g-Canted groove**, showing advancing sections of the rope; permissible with rope drive.

**h-Groove** for double obliquity.

**j-Short splice** for textile ropes.

**k-long splice** for textile ropes.

**l-Rope fastening** for coupling textile ropes.

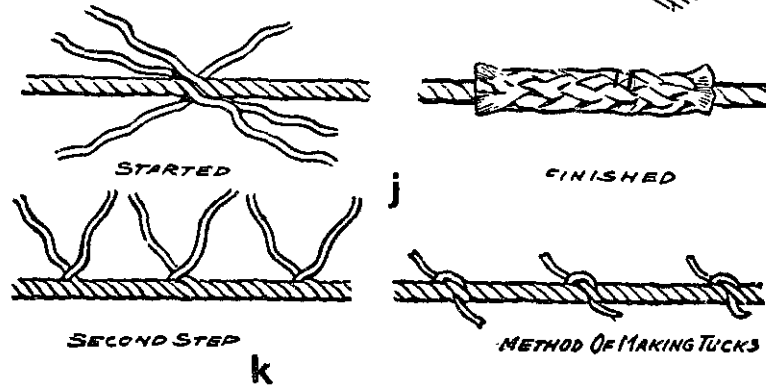
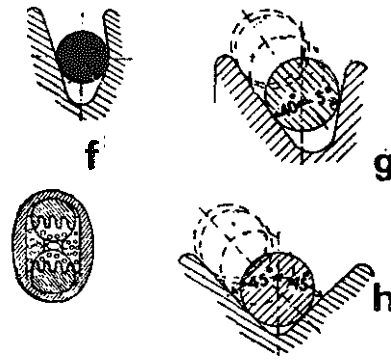
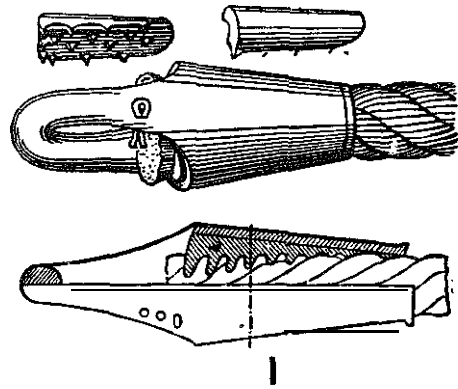
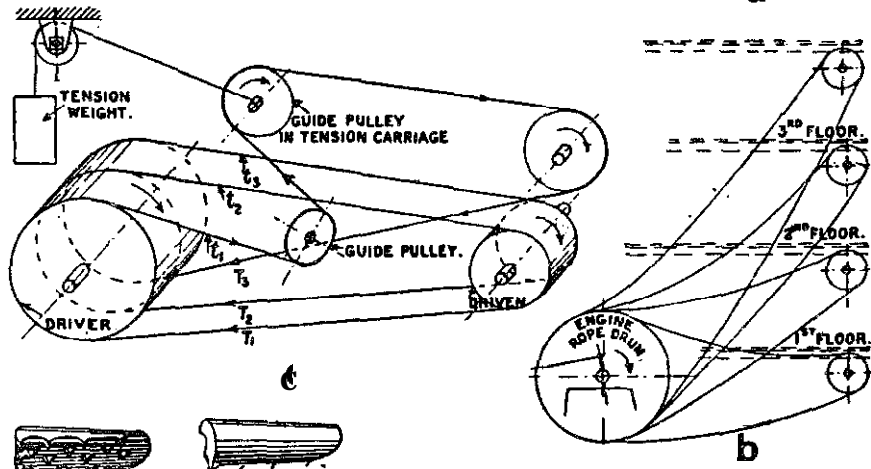
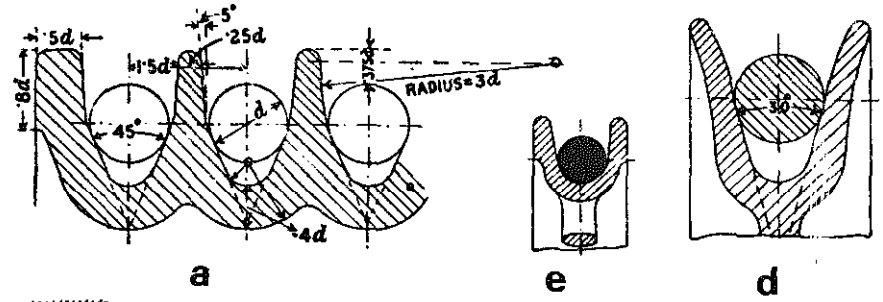

## C-Mechanical Transmissions

### 4-TEXTILE ROPE TRANSMISSIONS (Cont)

**m-Improved American continuous rope** drive with winder. (Medart)

**n-Split driven pulley;** section of figure "p" on line a, b.

**p-Split driven pulley.** See "b."

**q-Split driven pulley** section through MN of figure "p."

**r-Flywheel rim** with grooves for a rope and teeth for barring a pawl.

**s-Section of the rim** of an engine-rope drum.

**t-Mill driven** by cotton ropes. (Great Britain)

**u,v-Pulley** acting as flywheel of an engine; the wheel is 32 feet in diameter and has thirty-six grooves for ropes  $1 \frac{3}{8}$  inches in diameter.

**w-Travelling crane** driven by a cotton rope. (Great Britain)



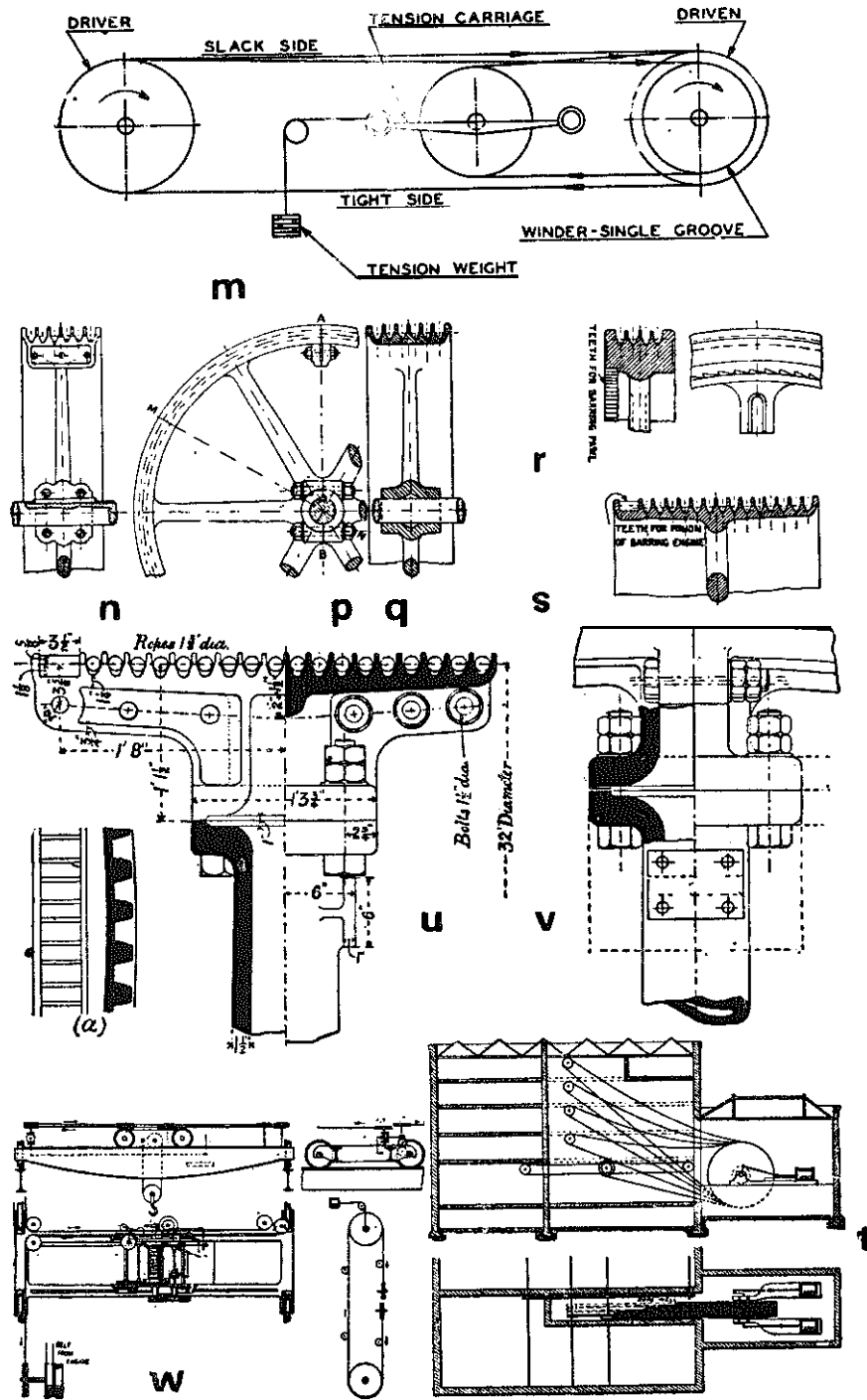

**C-Mechanical Transmission**

4-**TEXTILE ROPE TRANSMISSIONS (Cont).** Texrope and leather rope drives.

**x-variable-pitch sheave;** two grooves; low speed. (Allis-Chalmers)

**y-Variable-pitch sheave;** two grooves; high speed.

**z-variable-pitch sheave;** single groove; low speed.

**aa-Variable-pitch sheave;** single groove; high speed,

**ab-Texrope Vari-Pitch** speed changer at low speed,

**ac-Texrope Vari-Pitch** speed changer at high speed.

**ad-Square leather-rope drive.** Three belts shown. (Tullis)

**ae-Core leather-rope with cover.**

**af-V-core leather rope.**

**ag-Twisted leather rope.**

**ah-Round leather rope,** two and three-ply.

**aj-Twisted leather rope.**

**ak-Sheave** for twisted leather rope.

**al-Square-core leather rope.**

**an-Double control** sheaves arranged together to drive with twice-single variable-pitch range. (Allis-Chalmers)

**an-Round leather flexible** sectional belt.

**ap-Veelos** laminated adjustable V-belt. (Manheim Manufacturing and Belting Co.)

TEXTILE ROPE TRANSMISSIONS

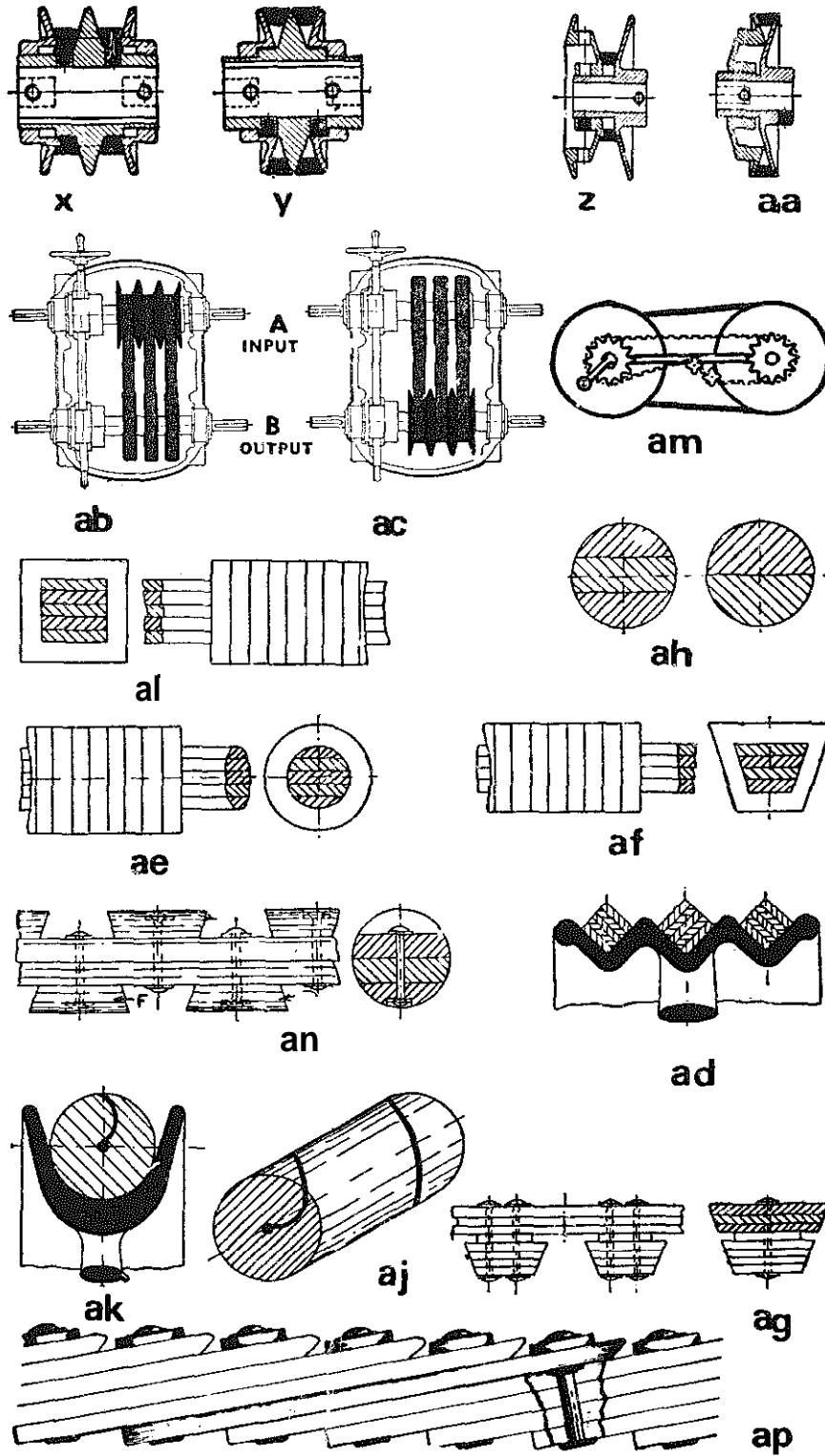

**C-Mechanical Transmission**

**5-BELT TRANSMISSION**-Most machines were driven from flat belts operating from a line shaft. The majority of new machines have individual motor drives and the V-belt replaces the flat belt more and more.

**a-Quarter-turn** method of flat-belt arrangement with shafts at right angles.

**b-Arrangement for shafts inclined to each other;** the center line of the belt advancing on the pulley should be in a plane passing through the midsection of the pulley at right angles to the shaft.

**c,d-Guide pulley positions** for an inclined shaft.

**e-Three-step cone pulley.**

**f-Five-step cone pulley.**

**g-Belt gear** for variable-speed machinery.

**h-Safety cap** for gib-headed key.

**j,k-Guide pulley positions** for an **inclined** shaft.

**l-Use of guide pulleys** to lengthen the belt when the shafts are too close together.

**m-Guide pulleys** with their axes in line; pulleys **M** are moved to right to receive the belt from pulley **A**.

**n-Use of guide pulleys** with shafts at right angles.

**o-Belt gear** for slow forward and quick return motion. Note open and crossed belts.

# BELT TRANSMISSION

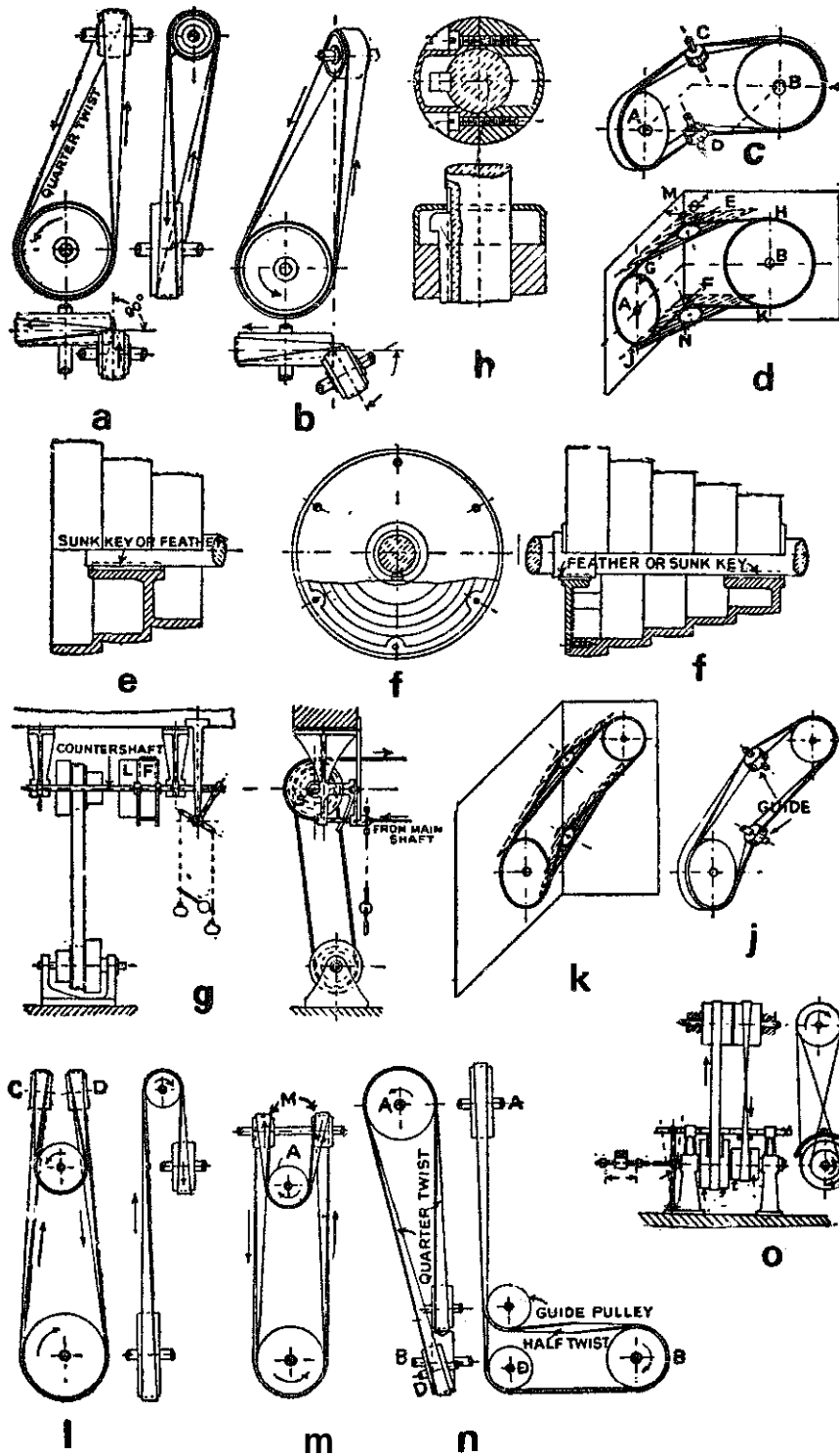

**C-Mechanical Transmission**

5-BELT TRANSMISSION (Cant)-V-belts are the most widely used form of belting. Their shape produces a wedging action in the grooves of the sheave and, therefore, a greater effective coefficient of friction is obtained.

**p-V-belt cross-section** showing textile cord as load carrying member. (Gates Rubber Company)

**q-V-belt cross-section** with steel-cord as load carrying member. (Browning Manufacturing Company;

**r-Keyed V-belt sheave** with three grooves, split taper bushing and key. (Browning Manufacutring Company)

**s-Double V-belt.** (Gates Rubber Company)

**t-Poly V-belt.** (Browning Manufacturing Company)

**u-Gilmer timing belts,** used where synchronism is a must.

**v-Gilmer timing belt** on cam shaft drive of racing car engine

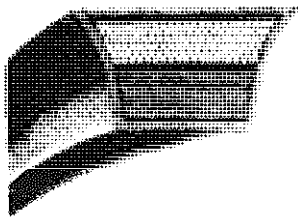

p

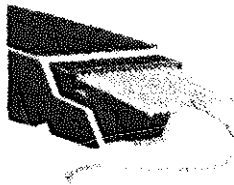

q

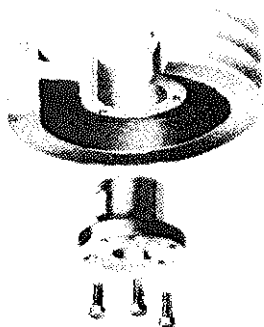

r

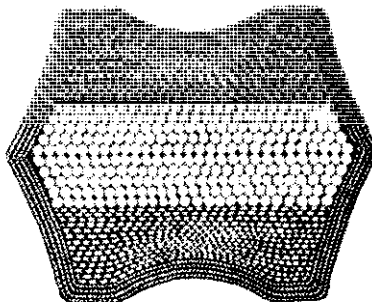

s

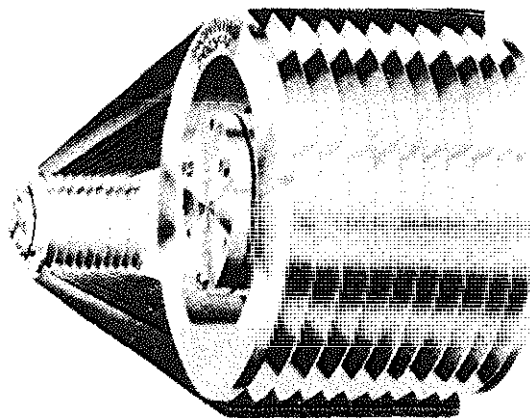

t

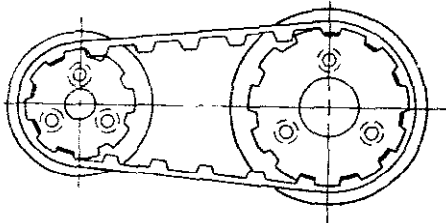

u

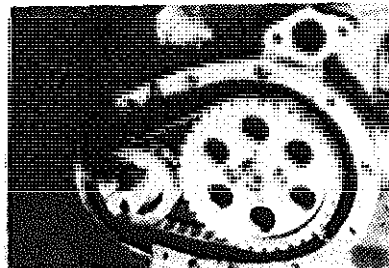

v

## C-Mechanical Transmission

### 6-BELT TIGHTENERS AND PULLEYS

**a-Belt tightener;** adjustable by spring tension or weight. This arrangement is also used for V-belt drives.

**b-Alternate method** of belt tightening.

**c-Tandem drive.**

d-Pulley.

e--To **shift the** position of a belt on a pulley, the advancing part of the belt must be displaced by the shifting fork.

**f-Displacing the retreating part** of a belt is wrong.

**g-Crowned pulley;** the belt will climb to the largest diameter and remain there; shifting or idler pulleys are flat while power transmitting pulleys are always crowned or rounded.

**h-Vertical pulley;** it has a flange or shroud at the bottom to take up the weight of the belt.

**j-Fast and loose pulley** arrangement for relief tension.

**k-Fast and loose pulleys** for the shaft of a machine. The fast pulley is keyed.

**l-Detail of a loose-pulley** bushing.

**m-Fast and loose pulleys** without bushing.

**n-Pulley arrangement** on the driving shaft with relief tension.

**o-Wall guide pulley** and fittings.

**p-Ceiling or floor guide pulleys.**

**q,r,s,t,u-Miscellaneous flat-belt** arrangements.



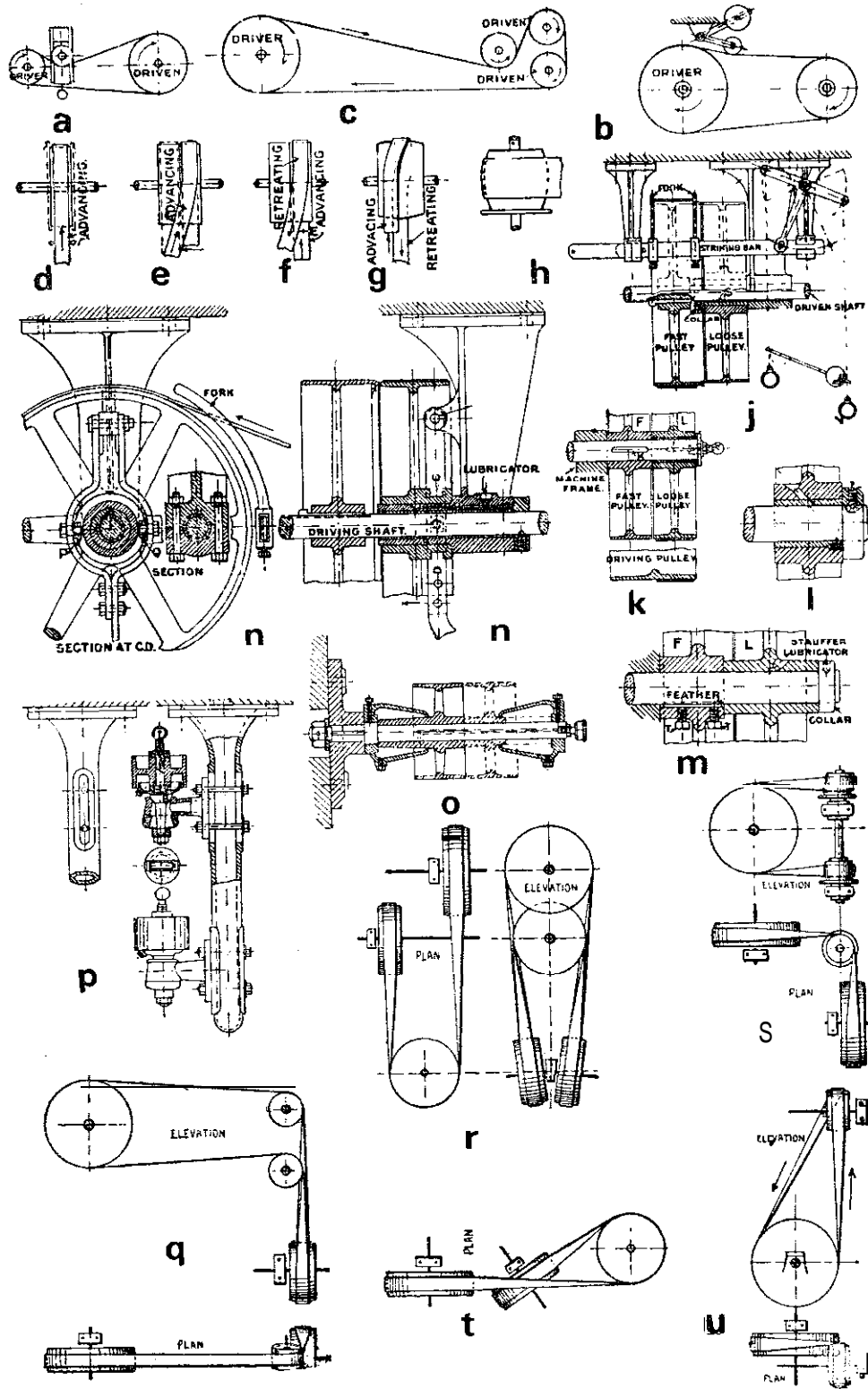

## C—Mechanical Transmission

7—BELT JOINTS AND FASTENERS—Belt Materials. Oak-tanned, center-stock, doubly-ply leather, made endless by cementing, is usually considered best for heavy-duty work. There are two general methods of arranging short-center drives of the flat-belt type. One consists in applying an idler pulley or tension roller on the slack side, near the smaller pulley. The other type consists of a pivoted motor to increase or decrease belt tension. Flat belts made of rubber are used in damp places. Textile belts made of cotton and hair are used where first costs are limited. When considered over a period of years, leather is more reliable than rubber or cotton flat belting. Thin flat steel belts have been used in Germany and the users claim many advantages.

Joints in Belting. Wherever possible, leather belts should be made endless with cemented laps. Endless belts cost less to maintain, wear longer and give better performance.

V-belts are now used in the majority of new applications.

**a,a—Preparing laps** for endless single leather belts.

**b,b—Preparing laps** for endless double leather belts.

**c,c—Alternate method** for laps of endless double leather belts.

**d—Belt stretcher** and clamp for cementing endless leather belts.

**e—Wire hooks** for round belting up to 3/8 in. diameter.

**f—Sewn joint** for rubber belt.

**g—Flanged and bolted joint.**

**h—Moxon's fastener** (Great Britain). 42

**j—Laminated** leather belting.

**k—Link** leather belt.

**l—Link** leather belt for rounded pulleys.

**m—Link** leather V-belt.

**n—Flat-link** leather belt.

**p—Moran steel-belt coupling** for round leather belts.

# BELT JOINTS & FASTENERS

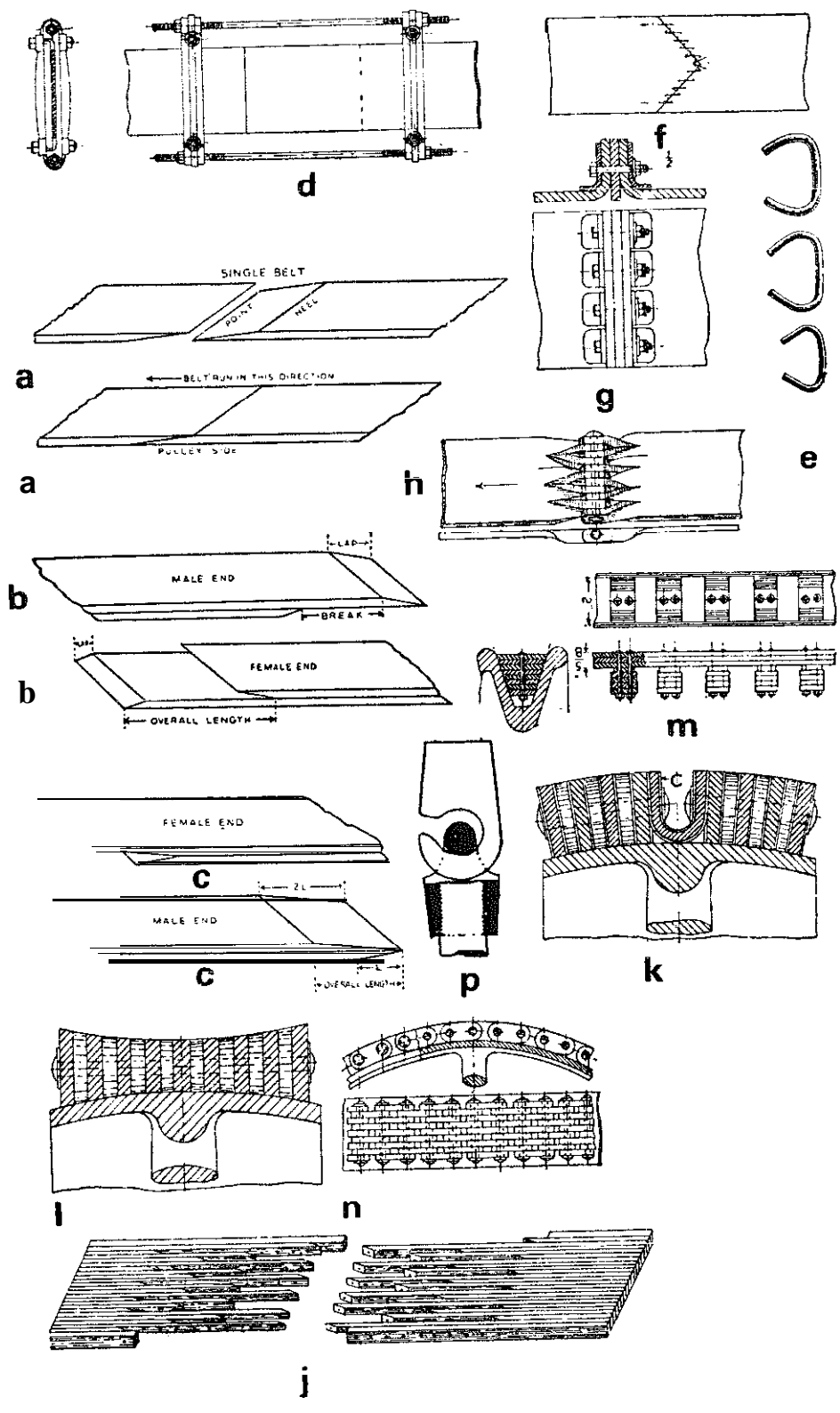

## C-Mechanical Transmission

### 7-BELT JOINTS AND FASTENERS (Cont)

q-**Stitched and cemented** belt joint.

r-**Double** belting.

s-**Laced lap** joint.

t-**Butt joint** with apron piece.

u,v-**Laced butt** joints.

w-**Pin and link** joint.

x-**Riveted and cemented** joint.

y-**Lacrelle's** fastening.

z-**Flattened-hook** joint.

aa-**Blake's stud** fastener.

ab-**Hook and eye** joint.

ac-**Hinge** fastening.

ad-**Metal spikes** used as belt fasteners.

ae-**Sonnenthal's** belt screw.

af-**Green's** belt stud; the ends of the belt are butted together and holes are punched through simultaneously; the fasteners are put in as shown at "a," twisted 90"; the band is next pulled straight and flattened with a hammer; the completed joint is shown at "b."

ag,ah-**Pin and link** joints.

BELT JOINT & FASTENERS

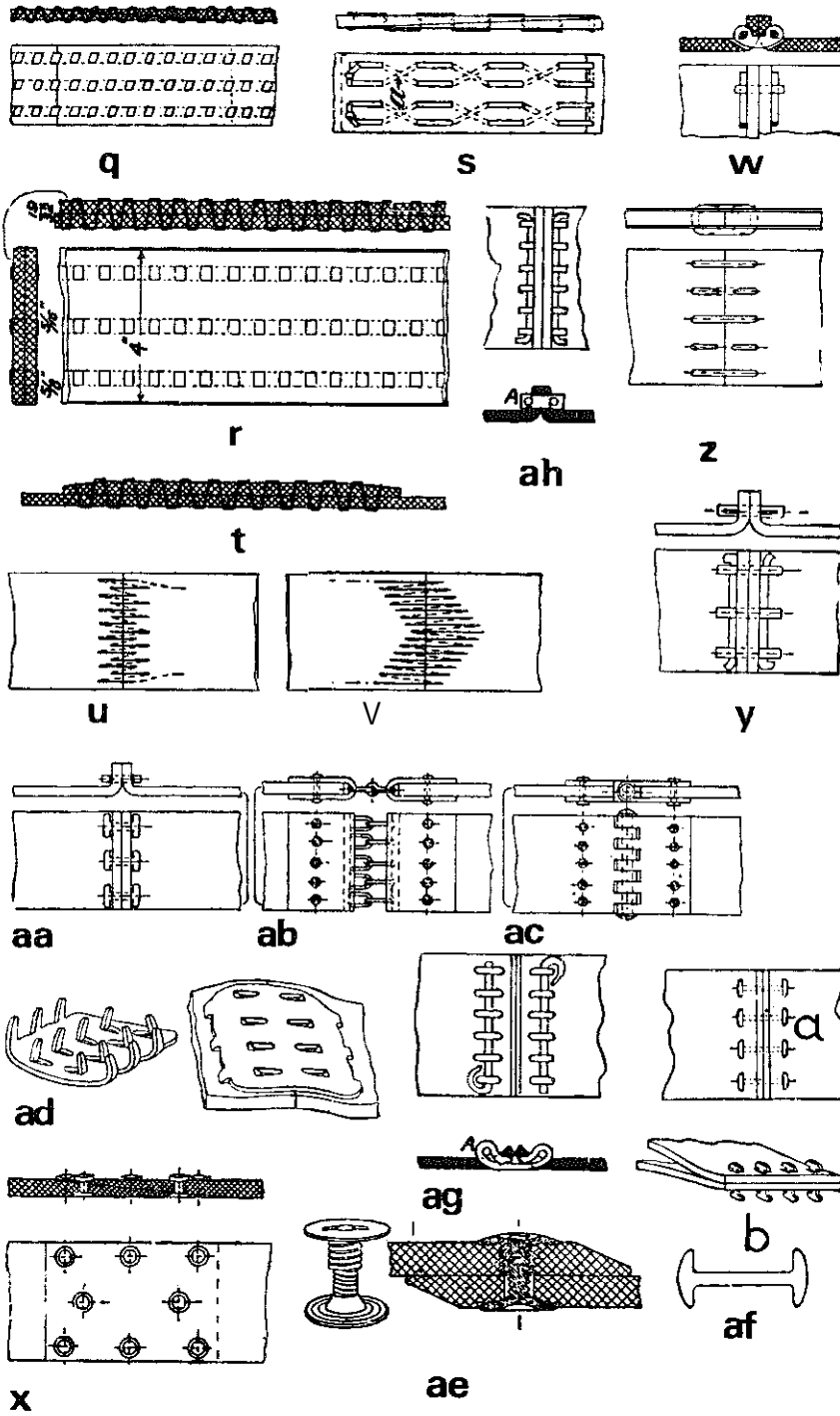

## C—Mechanical Transmission

### 8—CHAIN DRIVES

**a—Single flat-link** pitch chain without rollers; used on speeds up to 800 feet per minute; shown on sprocket.

**b—A.S.A. Standard roller** chain.

**c—Double flat-link** pitch chain.

**d—Benoit roller** chain.

**e—Block** chain.

**f,g—Renold's chain** shown on sprocket. (Great Britain)

**h—Morse silent** chain for high speeds.

**j—Frictionless rocker joint** for H.

**k—Morse roller** chain in double width.

**l—Morse roller** chain with extended pin; used on timing devices and in conveying.

**m—Brampton block** chain. (See "e").

**n—A.S.A. Standard triple strand** roller chain.

**o—Ladder** chain for light drives.

**p—Appleby's adjustable** chain for bicycles and light drives. (Replaced by standard chains).

**q—Appleby's machine** chain.

**r—Hornsby's** chain link.

**s—Hall's detachable** pitch chain.

**t—Ewart's detachable** link belt.

**u—Drip-feed** lubrication of chain drives.

**v—Oil-bath** lubrication.

**w—Sprocket-wheel and pitch-chain** assembly for very light duty.

**x—Link** belt and sprocket.

**y—Toothed** linked chain.

**z—Link** chain and sprocket. (German)

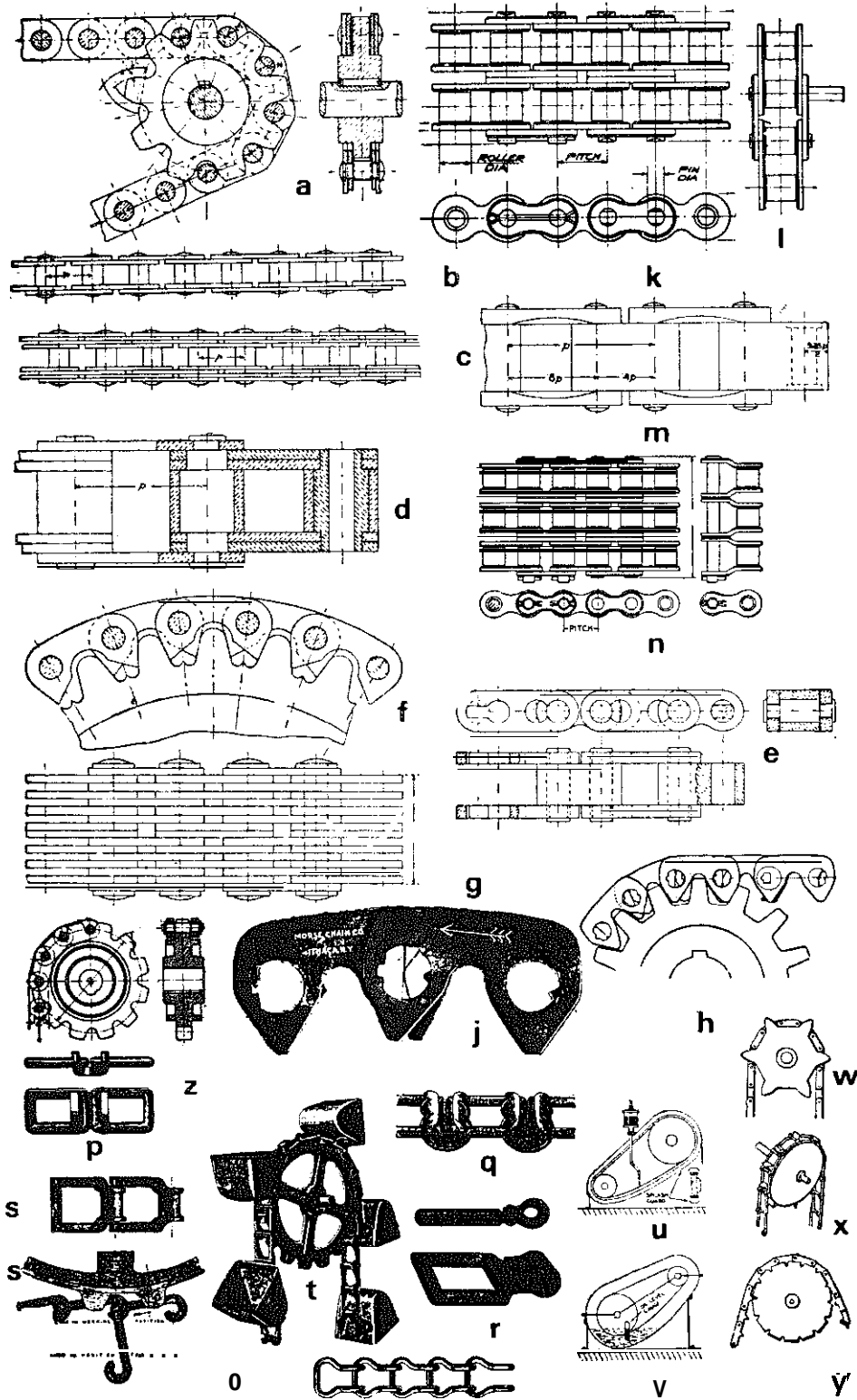

**C—Mechanical Transmission**

**8—CHAIN DRIVES (Cont)**

**aa—Bead chain.** This chain is used for very light drives.

**ab—Ewart detachable chain.** (Link-Belt Div. FMC Corp.)

**ac—Pintle chain.** (Link-Belt Div. FMC Corp.)

**ad—Inverted tooth chain.** (Silent chain).

**ae—Various pin links.**

**af—Straight link plate extension** for double pitch roller chain. (Link-Belt Div. FMC Corp.)

**ag—A.S.A. double pitch** drive chain.

**ah—Double pitch** conveyor chain.

**aj—Hollow pin chain double** pitch, rollerless type.

**ak—Deirin** clip-top chain.



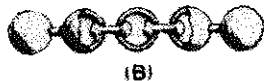

(B)

aa



ab

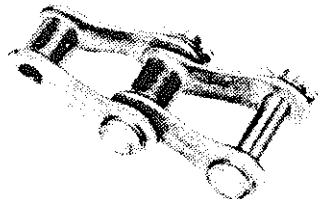

ac

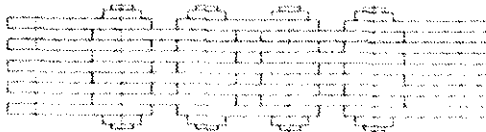

ad

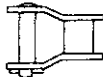
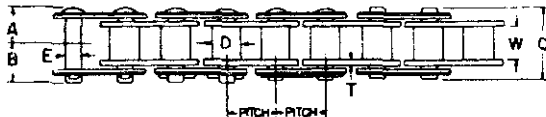

ae

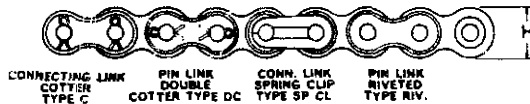

OFFSET LINK

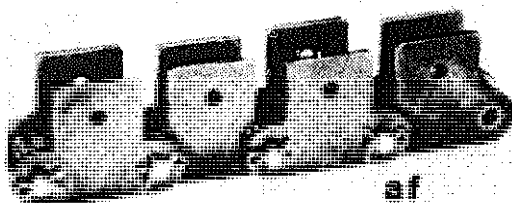

af



ag



ah

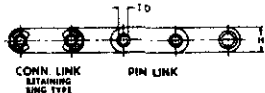
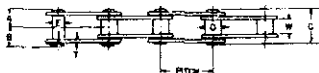

OFFSET SECTION

aj

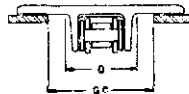
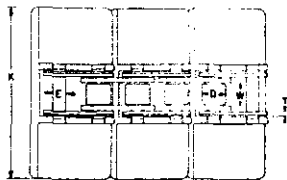

ak

## C-Mechanical Transmissions

### 9-DIFFERENTIAL PULLEYS AND WINCHES

**a**—Moore's **differential pulley block**.

**b**—**Weston's differential pulley block**; consists of a two-grooved pitched chain sheave having different numbers of teeth, in combination with a return block and endless chain.

**c**—Worm gear **pulley block**.

**d**—**Differential pulley block**. (German)

**e**—**Differential pulley block** for light work. (German)

**f**—**Hoisting drums** and quadruple block. (German)

**g**—**Electric hoist**. (German)

**h**—**Hand hoist**. (German)

**j**—**Travelling hoist**.

k—**Jack**. (German)

**m**—**Chain offset**. (German)

**n**—**Chain sheaves** and fittings.

DIFFERENTIAL PULLEYS & WINCHES

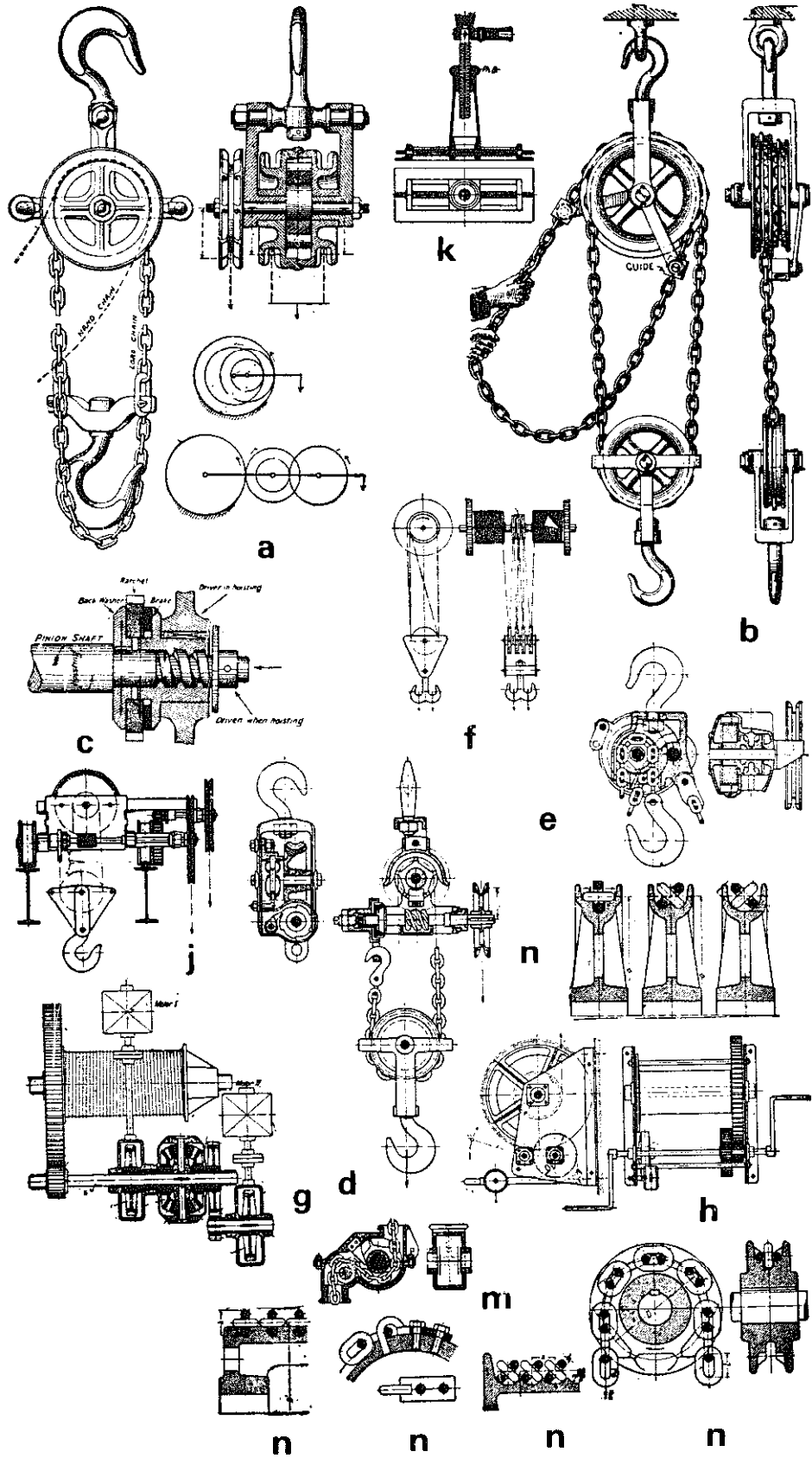

C—Mechanical Transmission

10—CHAINS, HOOKS AND FITTINGS

a—Links of ordinary close chain, short link, rigging or crane chain.

b—Oval stud link with broad-headed stud.

c—Oval stud link with pointed stud.

d—Parallel-sided stud link.

e—Obtuse-angled stud link.

f,g—Scarfed joints.

h,j,k—The effect of wear on links.

l—Spring catch which prevents the chain from working loosely.

m—Ball-bearing hook which reduces friction in swiveling.

n—Foundry-charge hook.

o—Ramshorn or double-crane hooks.

p—Ordinary swivel hook.

q—Ramshorn or double hook.

r—Single-sling or lashing chain.

s—Shackle and swivel.

t—Stopper for riding bits. (Blake)

u—Ordinary cable swivel.

v—Chain with shackle.

w—Screwed messenger link.

x—Screwed D-shackle (ordinary chain type).

y—Cotter messenger link.

z—Francis split link.

aa—Split link.

ab—Harp shackle with forelock (anchor type).

ac—Screwed connecting link.

ad—Chain tighteners or screws for sling chains.

ae,af—Chains allowing alternate links to lie flat on the sheave.

ag,ah—Chain sheaves with curved groove.

aj—Variety of “ag.”

ak—Cargo hook.

al—Shunting hook (Liverpool type).

am—Locking device.

CHAINS, HOOKS & FITTINGS

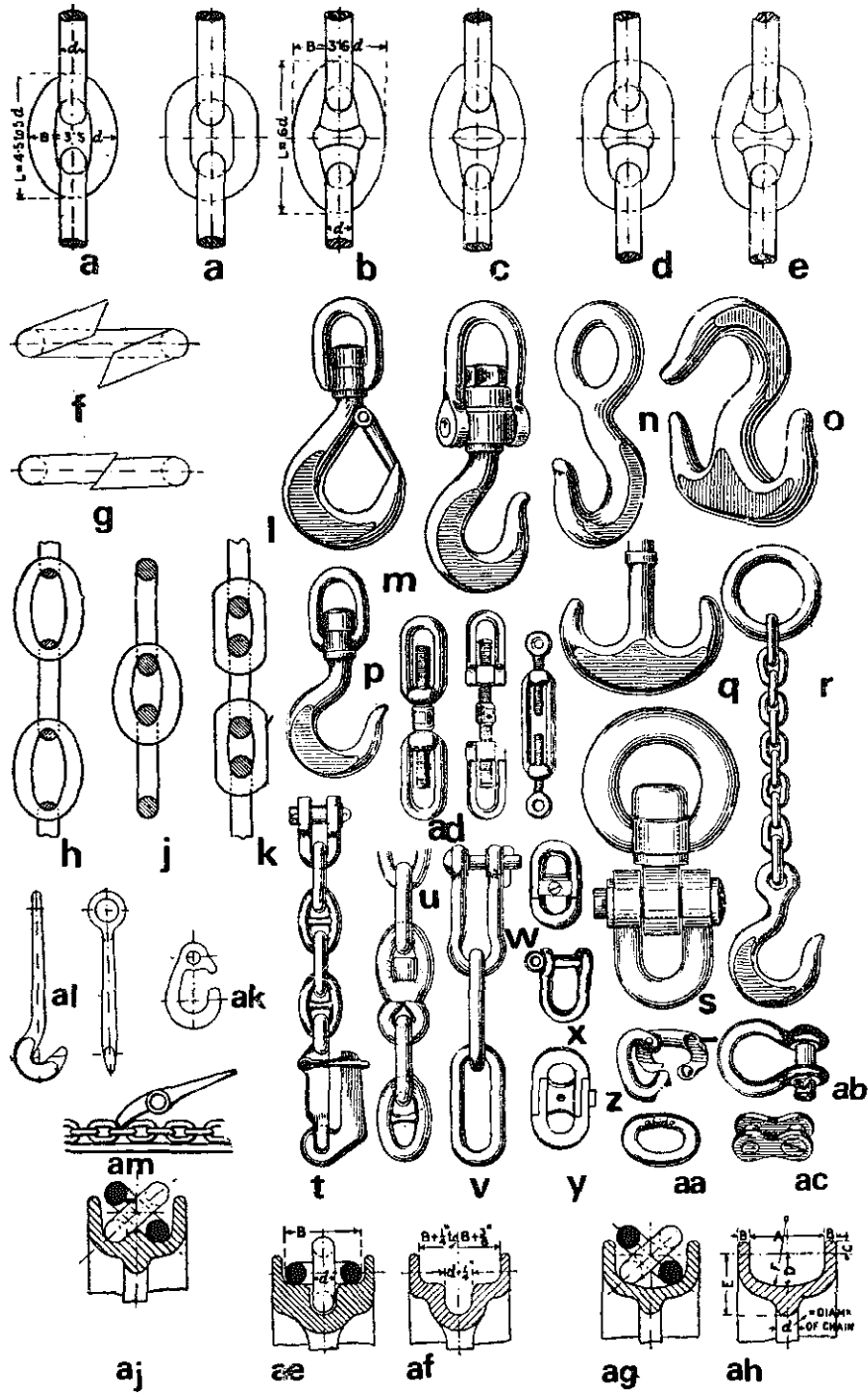

## C-Mechanical Transmissions

### 10-CHAINS, HOOKS AND FITTINGS (Cont)

- an—Fixed-bar hook with snap.
- ap—Snap hook.
- aq—Slip hook with catch.
- ar,as—Slip hooks.
- at—Double or **match hooks**.
- au—Self-locking hook with pin and inclined shoulder.
- av—The common “Lewis.”
- aw—Self-gripping claw grab.
- ax—Grab bucket.
- ay,az,ba—Double S-links.
- bb—Snap link.
- bc—Automatic slip hook.
- bd—Self-locking draw-bar hook.
- be—Safety link; it has a flat on the link to slip through a notch
- bf—S-link.
- bg—Split link.
- bh—Hook with rope grip.
- bj—Split link.
- bk—Hook eye for guy rope.
- bl—Slip hook for pile driver.
- bm—Loop or eye shackle.
- bn—Swivel-snap hook.
- bp—Swivel shackle.
- bq—Spring-snap hook.
- br—Grip hook.
- bs—Slip hook for towing.
- bt—Towing hook with mousing rope.
- bu—Swivel-snap hook.
- bv—Double link and bolt connection.

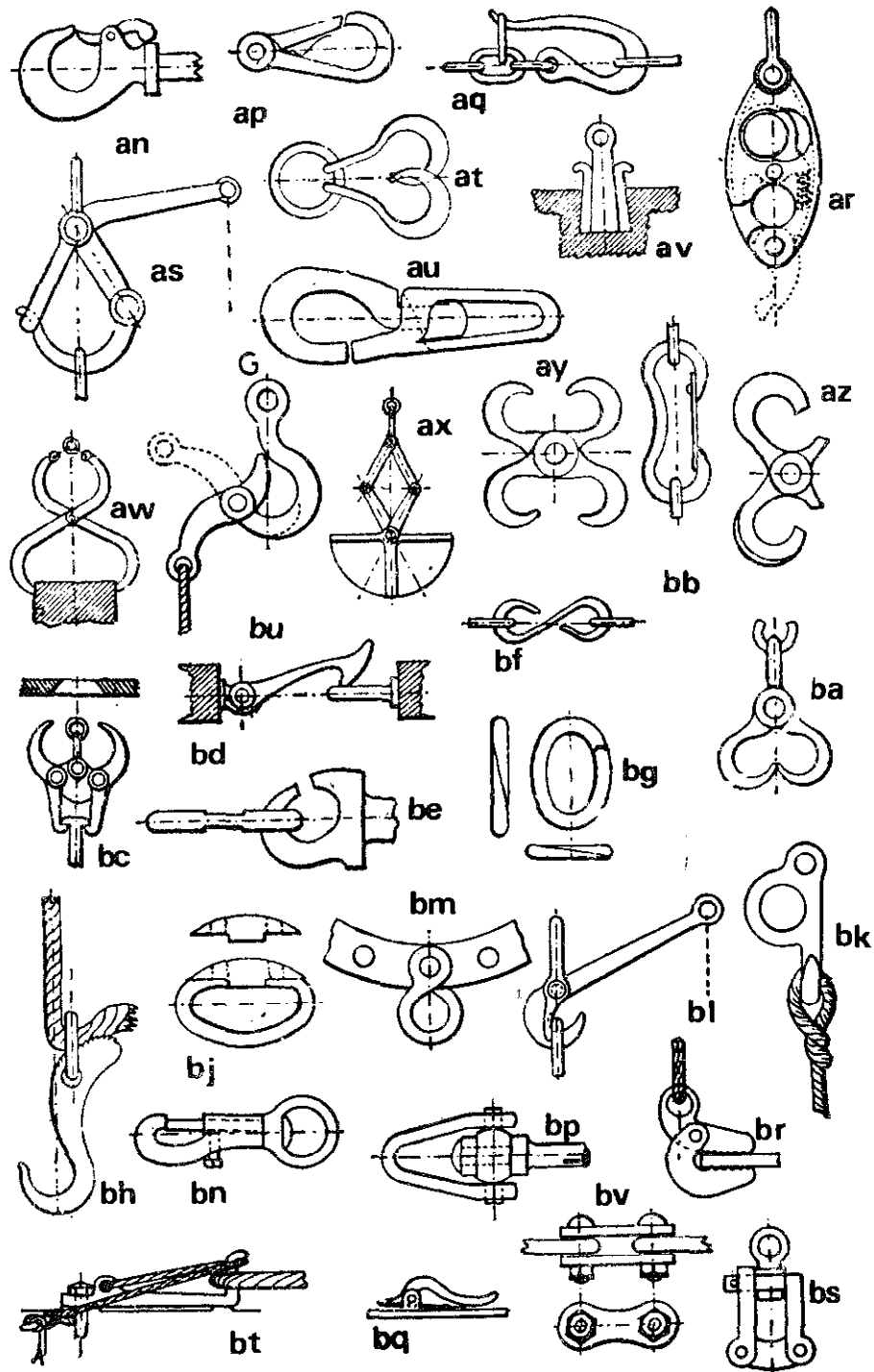

11-BLOCKS AND TACKLES

a-Differential pulley;  $W \div P =$



is the mechanical advantage

**b-Block and tackle;** it has a mechanical advantage of 2 for each movable pulley; in this case  $3 \times 2 = 6$ ;  $P = W \div 6$ .

**c-Single whip;**  $P = W$ ; \*  $\frac{P}{W} = \frac{11}{10}$ \*\*

**d-Single whip with block at weight;**  $\frac{P}{W} = \frac{10}{20}$ ;  $\frac{P}{W} = \frac{12}{20}$

**e-Gun tackle purchase;**  $\frac{P}{W} = \frac{10}{20}$ ;  $\frac{P}{W} = \frac{12}{20}$

**f-The same inverted;**  $\frac{P}{W} = \frac{10}{30}$ ;  $\frac{P}{W} = \frac{13}{30}$

**g-Luff tackle;**  $\frac{P}{W} = \frac{10}{30}$ ;  $\frac{P}{W} = \frac{13}{30}$

**h-The same inverted;**  $\frac{P}{W} = \frac{10}{40}$ ;  $\frac{P}{W} = \frac{14}{40}$

**j-Double purchase;**  $\frac{P}{W} = \frac{10}{40}$ ;  $\frac{P}{W} = \frac{14}{40}$

**k-The same inverted;**  $\frac{P}{W} = \frac{10}{50}$ ;  $\frac{P}{w} = \frac{15}{50}$

**l-Spanish Burton;**  $\frac{P}{W} = \frac{10}{30}$ ;  $\frac{P}{w} = \frac{13}{30}$

**m-Double Spanish Burton;**  $\frac{P}{W} = \frac{10}{50}$ ;  $\frac{P}{W} = \frac{15}{50}$

**n-Bell purchase;**  $\frac{P}{W} = \frac{10}{70}$ ;  $\frac{P}{w} = \frac{17}{70}$

**o-Luff upon luff;**  $\frac{P}{W} = \frac{10}{160}$ ;  $\frac{P}{W} = \frac{26}{160}$

\*In c to o, the first equation shows the ratio of power to weight friction not considered.

\*\*In c to o, the second equation shows the ratio of power to weight friction considered. (10% Loss Assumed).



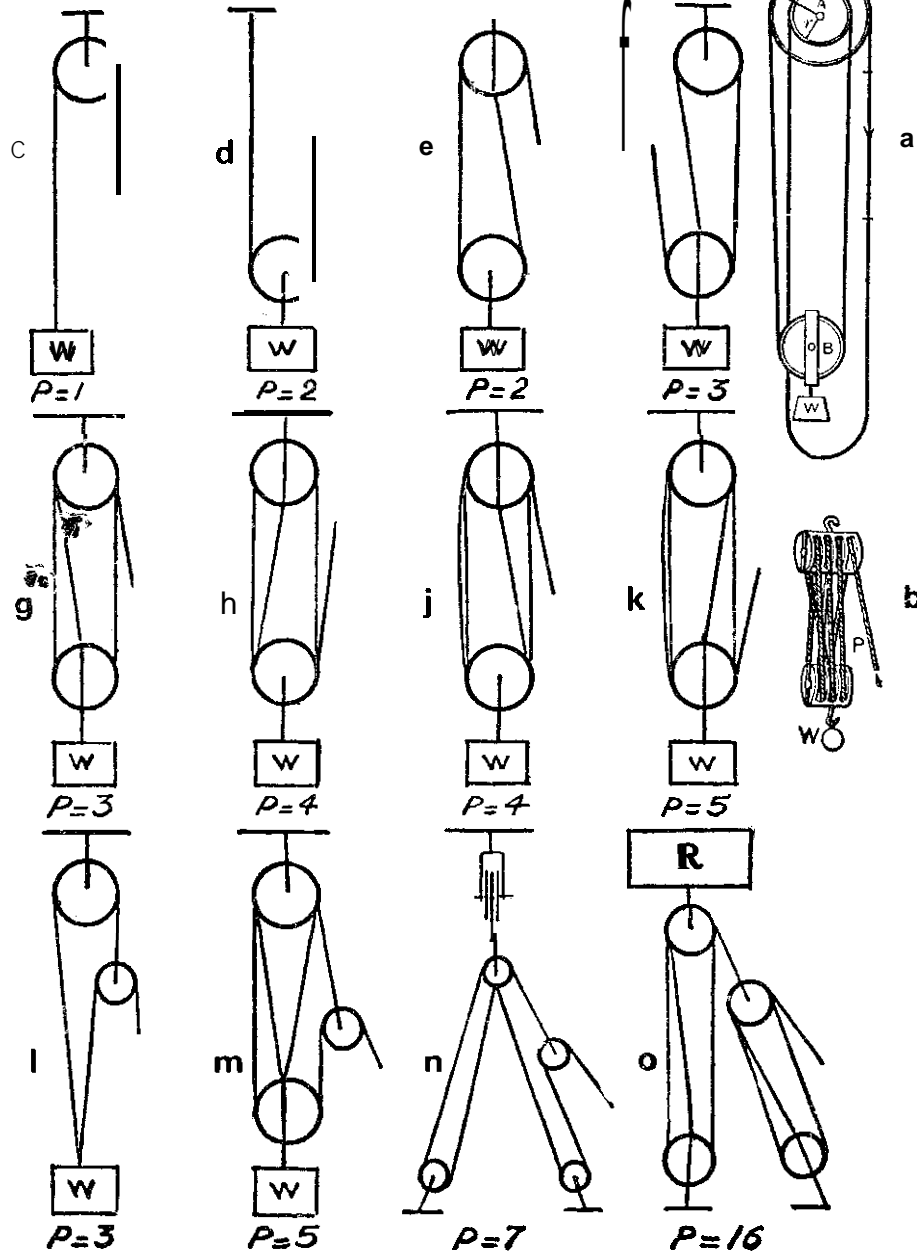

## C—Mechanical Transmissions

### 12—MOTION TRANSMISSIONS

- a—Flexible shaft** for light driving; used for drilling in difficult positions.
- b—Radiating arm and bevel gear**; the movable machine can be driven at any point within the circumference of the circle described by the arm head.
- c—Revel gear and feather shaft**; the movable machine travels in a straight line in the length of the shaft and also radially.
- d—Screw and worm-wheel gear**; for the same purpose as “c.”
- e—Steam or hydraulic pivoting arm and cylinder device**; for the same purpose as “c.”
- f—Central-cylinder and pivoting motion** for the same purpose as “c.”
- g—Jointed radiating arms**, with belt gear for conveying motion from a central spindle to one having a travel covering any point within a circle of the extreme radius of the jointed arms.
- h—Swivel-jointed tube** for a traveling, hydraulic, steam or compressed-air hoisting or other engine.
- j—A traveling gear** may be driven by a long pinion without affecting the movement of the wheel.
- k—Traveling spur gear** similar to “j” to convey continuous motion to a traveling machine.
- l—Telescopic swinging-shaft movement** with universal joint at each end.
- m—Helical-gear drive** for a traveling pinion.
- n—Endless cord drive** to a machine having limited movement.
- o—Parallel-motion swivelling driving device**; with a limited vertical travel and a radial motion.
- p—Traveling gear and slot**; the driven wheel “a” has a limited travel up and down the slot, the idle gear wheel “b” being kept in gear by the link suspension.
- q—Pivoting arm and belt**; the movable machine can be driven at any point in the circumference of the circle described by the arm head.
- r—Endless round rope-belt drive**; it is kept tight in any position in the plane of the driving pulley by a weighted pulley; the machine can be moved to any position in the plane of the driving pulley, the weighted pulley taking up the slack in the belt.
- s—Motion conveyed by belt** to a driven shaft having a radial motion in a vertical plane.
- t—Rock drill** operated by compressed air, with hose connection.
- u—Locomotive air brake.**
- v—Flexible steam joint.**
- w—Transmission of motion** by electricity.
- x—Electric and magnetic waves** generated by an oscillating electric current.
- y—Electric hoist.**
- z—Idler (gear) and slot**; a common device for changing direction or speed in driving gear by connecting or disconnecting it with intermediate gearing between a fixed driving and a driven shaft.

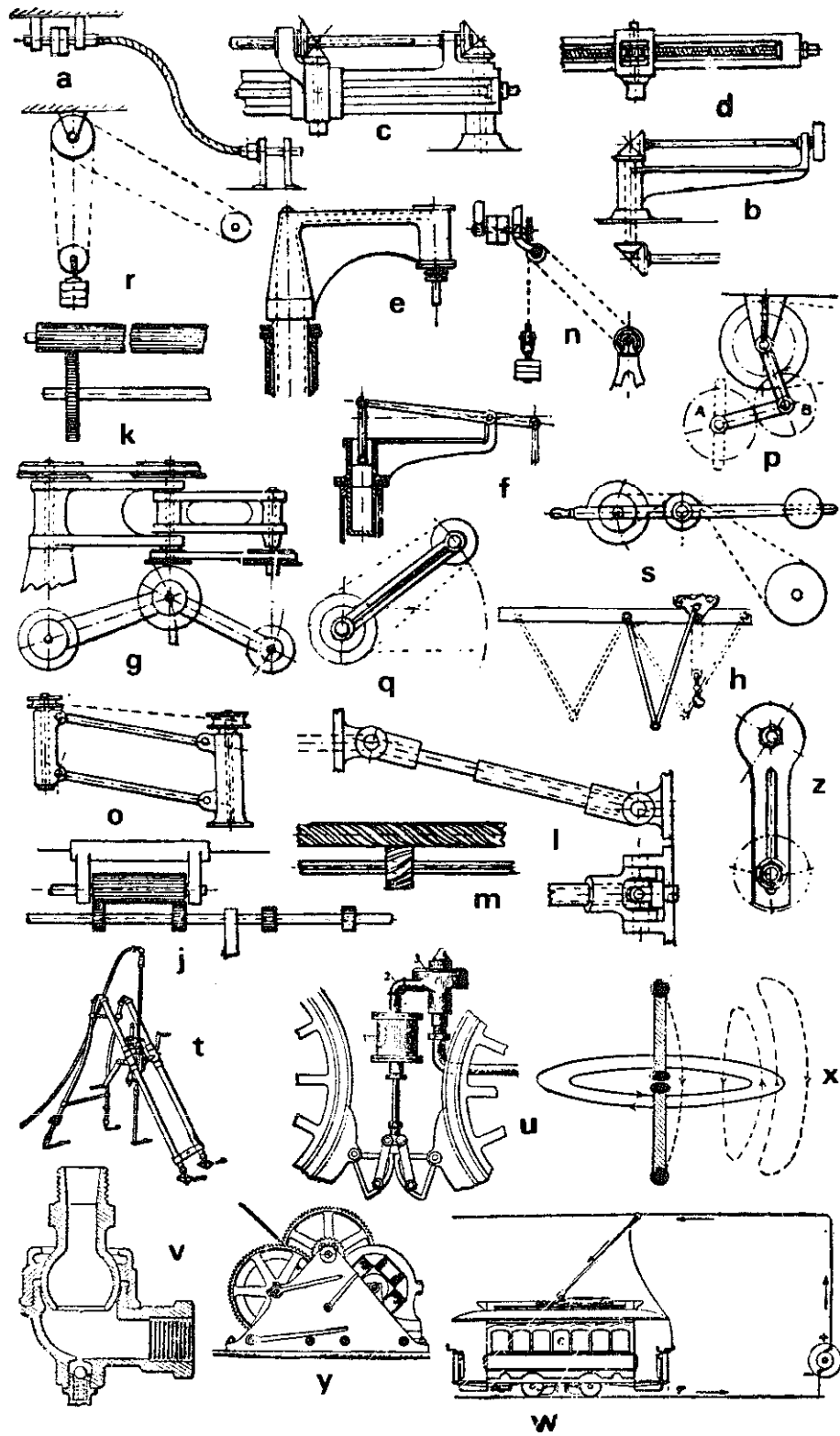

**C—Mechanical Transmissions**

**12-MOTION TRANSMISSIONS (Cont)**

**aa,ab,ac,ad,ae,af—Piston centers.**

**ag—Eyelet center.**

**ah—Pivoting ball center.**

**aj,ak—Rocking center.**

**al—Swivelling pipe joint.**

**am—Universal hinge; the arm can be fixed in any position.**

**an—Ball joint; it can be fixed in any position.**

**ap—Ball and cup joint.**

**aq,ar—Hooke's universal joints.**

**as—Universal hinge; it can be fixed in any position by tightening the gland.**

**at—Ball castor.**

**au—Typical line shaft.**

MOTION TRANSMISSIONS

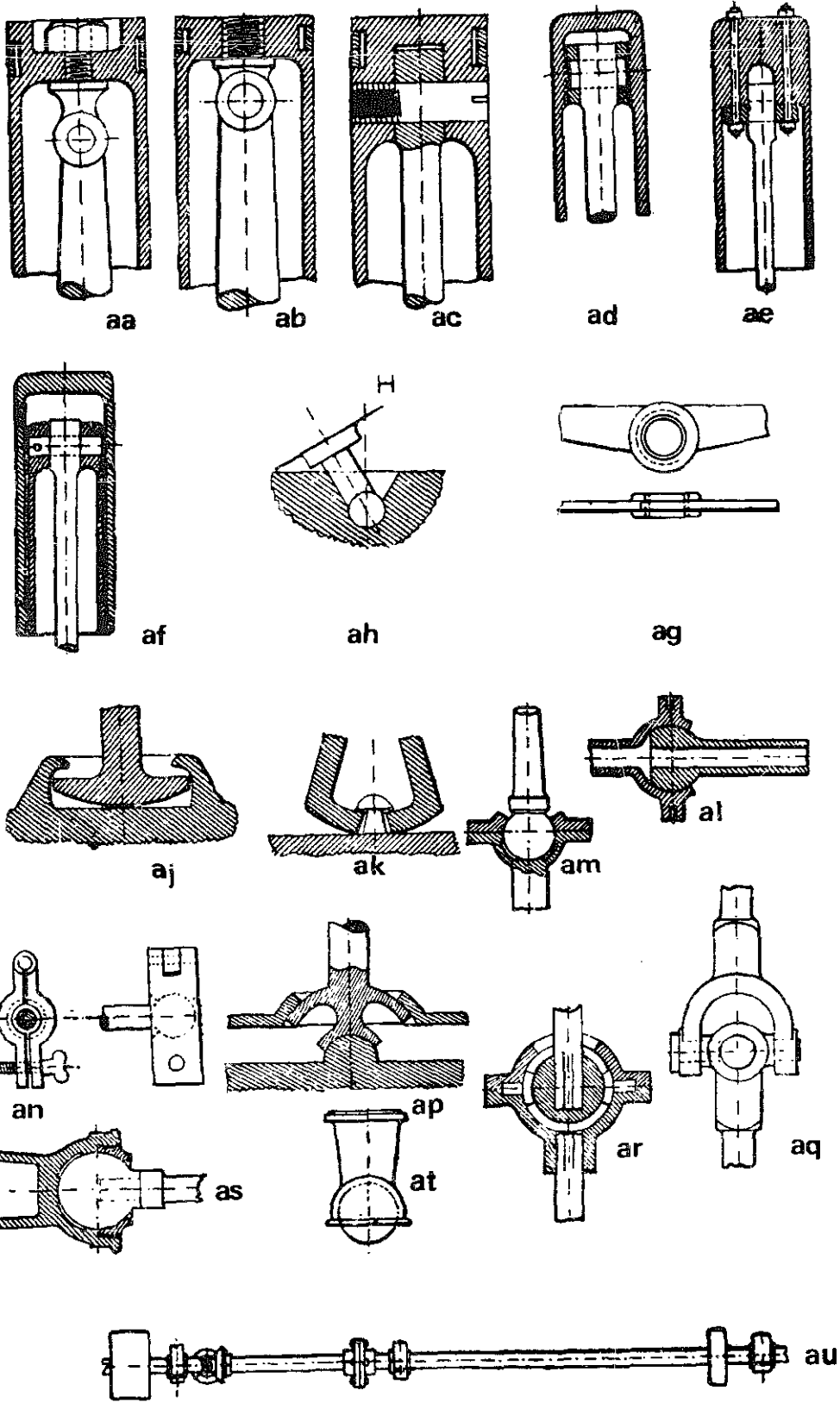

### C—Mechanical Transmissions

13—SHOCK MOUNTS AND VIBRATION ISOLATORS—Shock is a disturbance produced by a suddenly applied load. Vibration is a steady state oscillation as produced by an unbalanced machine. Damping introduced by adding of a resilient material makes a vibrating object come to rest quicker than without it.

**a—Vibration isolator.** Plate isomode unit. (MB Electronics, Div. of Textron Electronics Inc.)

**b—Vibration isolator** using rubber in shear. Tubeform. (Lord Manufacturing Co.)

c—Same as “b.” **Plate form mounting.** (Lord Manufacturing Co.)

**d—Vibration isolator. Chan-L-Mount.** (Lord Manufacturing Co.)

**e—Vibration isolator.** Lattice mounting. (Lord Manufacturing Co.)

**f—Typical mount of a vibration isolator.** (Lord Manufacturing Co.)

g—Base mounting assembly. Helical isolator with closely controlled spring rates in all three directions. (Aeroflex Laboratories Inc.)

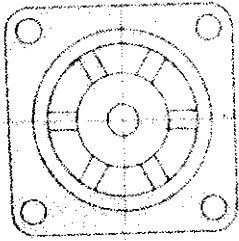

b

c

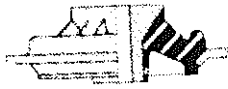

a

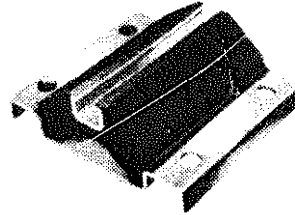

d

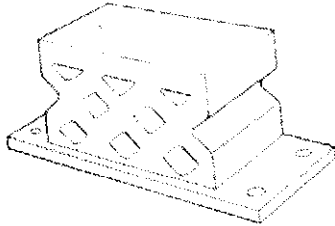

e

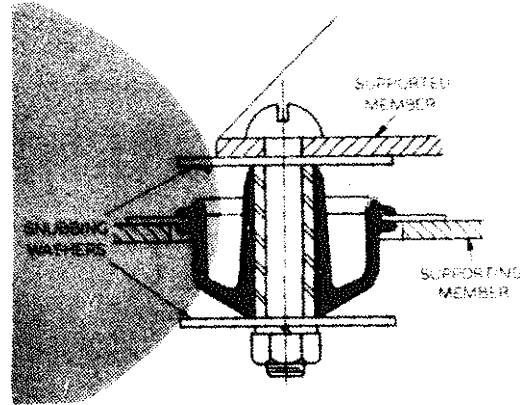

f

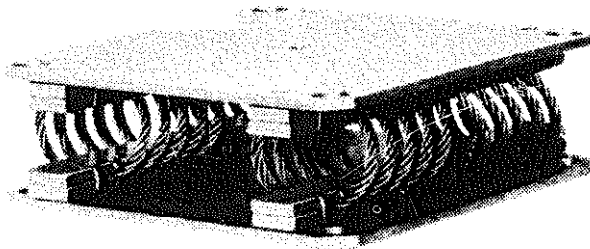

g

D—Mechanisms and Kinematics

I-CONTRACTING AND EXPANDING MECHANISMS

a,b,c—**Parallel bar** expanding grilles or gates.

d—**Lazy tongs**.

e-Expanding **screen**.

f—**Venetian blind**; used for folding doors.

g-Expanding **basket**.

h—**Car bumper**.

j-Expanding **chuck** or mandrel.

k-Expanding socket formed from spring wire

l-Expanding **socket**.

m-Expanding **tripod**.

n-Expanding gate.

p-Expanding **pulley**.

q-Expanding pulley.

r-Expanding pulley, before rim is added.

s-Expanding **pipe grip**.

t-Expanding legs **for tripod**.

u-Expanding **link device** with four guides.

v—**Perforated bar** and **hooked-rod hanger**.

w-Expanding grating for a gate.



CONTRACTING & EXPANDING MECHANISMS



a

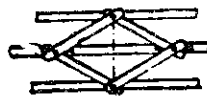

b



c

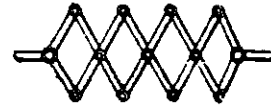

d

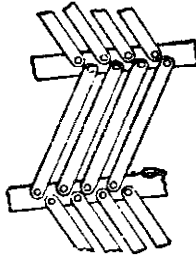

e

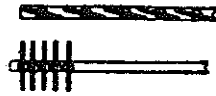

f

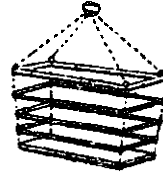

g

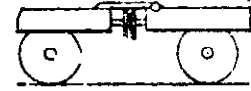

h

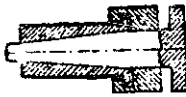

i

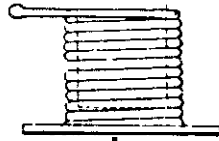

k

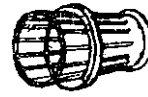

l

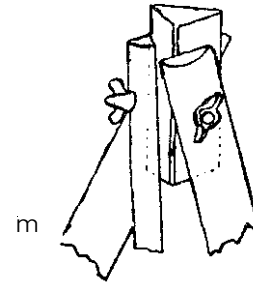

m

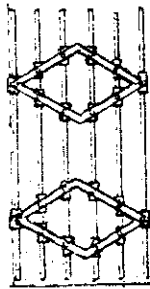

n

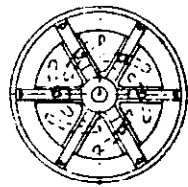

p

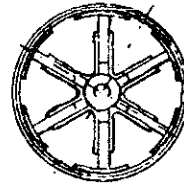

q

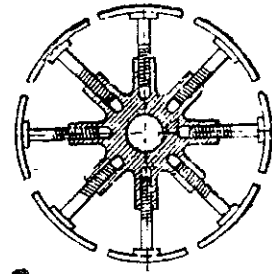

r

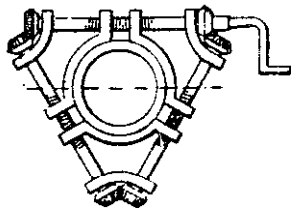

s



t

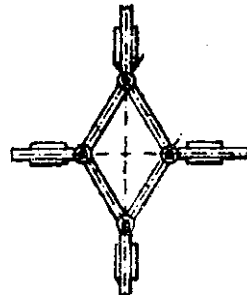

u



v



w

## D-Mechanisms and Kinematics

### I-CONTRACTING AND EXPANDING MECHANISMS (cont)

x-Expanding **pipe stoppers** with rubber ring. Action through bulging of rubber ring. Leak tight if properly arranged.

y-Expanding mandrel with three parallel feathers expanded by a central bolt with two equal cones.

z-**Telescopic ram** of hydraulic lift.

aa-**Tube expander.**

ab-Expanding **boring tool** has central cone and three or more diagonal feathers sliding in dove tails of central groove.

ac-Expanding collar, consisting of two rings with spiral adjacent faces, as they expand longitudinally they turn with respect to each other.

ad-Expanding **reamer**. Split into three parts to the end of the bolt.

ae-**Mandrel with taper screw.**

af-Expanding collars screwed one on the other.

ag-Expanding **collet** split in three parts.

al-Expanding **mandrel** split alternately from each end, is tapered in the bore to fit tapered mandrel.

aj-**Steam trap** using charged metal bellows for power element.

ak-Direct expansion-type **thermostat**. Expanding element shuts off port.

al-**Organ bellows.**

am-**Diaphragm** type thermostat. Volatile liquid expands and contracts with temperature.

an-**Spiral-type bimetallic** thermostat. Tilts mercury switch on expansion, thus switching on power.

ap-**Taper tube** rolling.

aq-**"Mannesmann process"** of seamless tube fabrication. A-corrugated rolls, B-guide tube, B'-hot bar. Expansion through mandrel.

ar-**Straight strip** type bimetallic thermostat.

as-**gasometer**. Steel structure guides cylindrical gas tank through wheels. Bottom of tank holds water or other fluid as seal. Gas inlet and outlet pipes not shown.

CONTRACTING & EXPANDING MECHANISMS

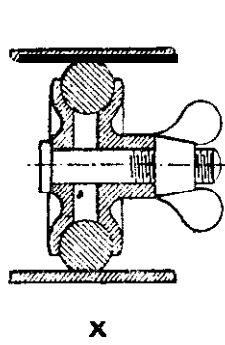

x

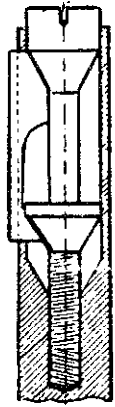

y

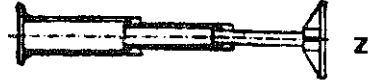

z

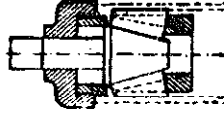

aa

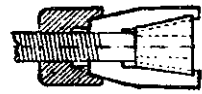

ab

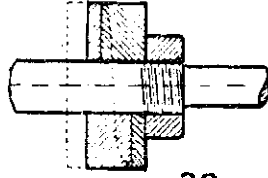

ac

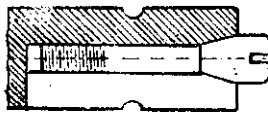

ad



ae

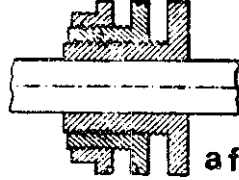

af

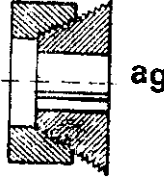

ag



ah

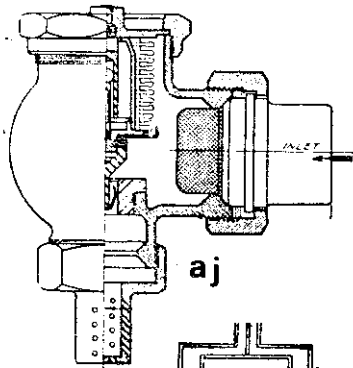

aj

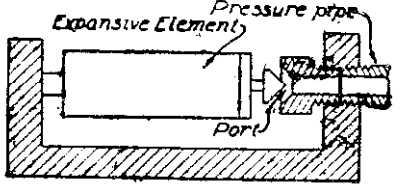

ak

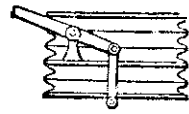

al

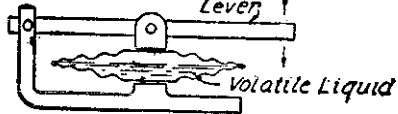

am

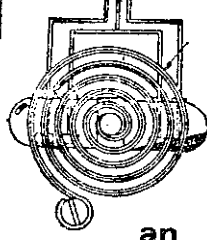

an

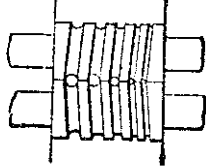

ap

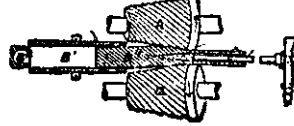

aq

ar

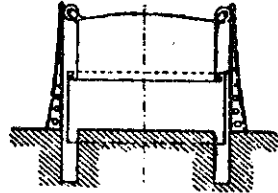

as

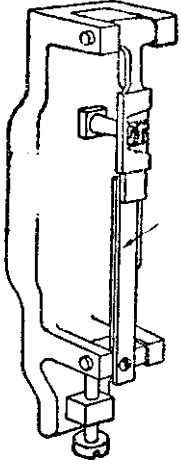

## D-Mechanisms and Kinematics

### 2-DIFFERENTIAL GEARING

**a-Standard differential winch** consists of two drums of different diameter, and a cable anchored at their ends. Cable is wound clockwise on one drum and counterclockwise on the other.

**b**-Two gears, one of which has one to three teeth less than the other, engage one pinion.

**c-Simple differential** using bevel gears. The output is the rotation of the arm if the input is through the two shafts. The input-output speed relationship is

$$W = \frac{W_1 + W_2}{2}$$

where  $W$  is the speed of the arm, and  $W_1$  and  $W_2$  the speeds of the shafts.  $W$  may be positive or negative, depending on the direction of rotation.

**d-Spur gear** differential. Same comment as under "c".

**e-Automotive** differential. Technically not a differential, since we have one input and two outputs. It divides input torque equally between rear wheels. Its differential effect comes in curves when wheels operate at different speeds. (Rear axles 2 and 4. hypoid ring gear 5).

**f-Modern precision** differential used as high accuracy computing mechanism. Formulas and description as under "c" except the input comes through the input gears. (Reeves Instrument Corp.)

**g-An application** of "b" to pulley blocks.

**h-Differential screw**. Screws may be both of the same hand or opposite hand. Any fractional speed can be obtained by proportioning pitches.

**j-Differential accumulator**. Effective area of ram is the annular shoulder, which is the difference in areas between top and bottom ram.

**k-Differential pulley block**, consisting of a two grooved pitched chain sheave having different number of teeth in combination with an endless chain and return block.

**l-Differential screw-valve fitting**, with cone seat tightened by the T-head and fine thread central screw. Used for gas containers.

**m-Differential piston indicator** for steam engines.

**n-Differential-screw bolt and sleeve** movement.

# DIFFERENTIAL GEARING

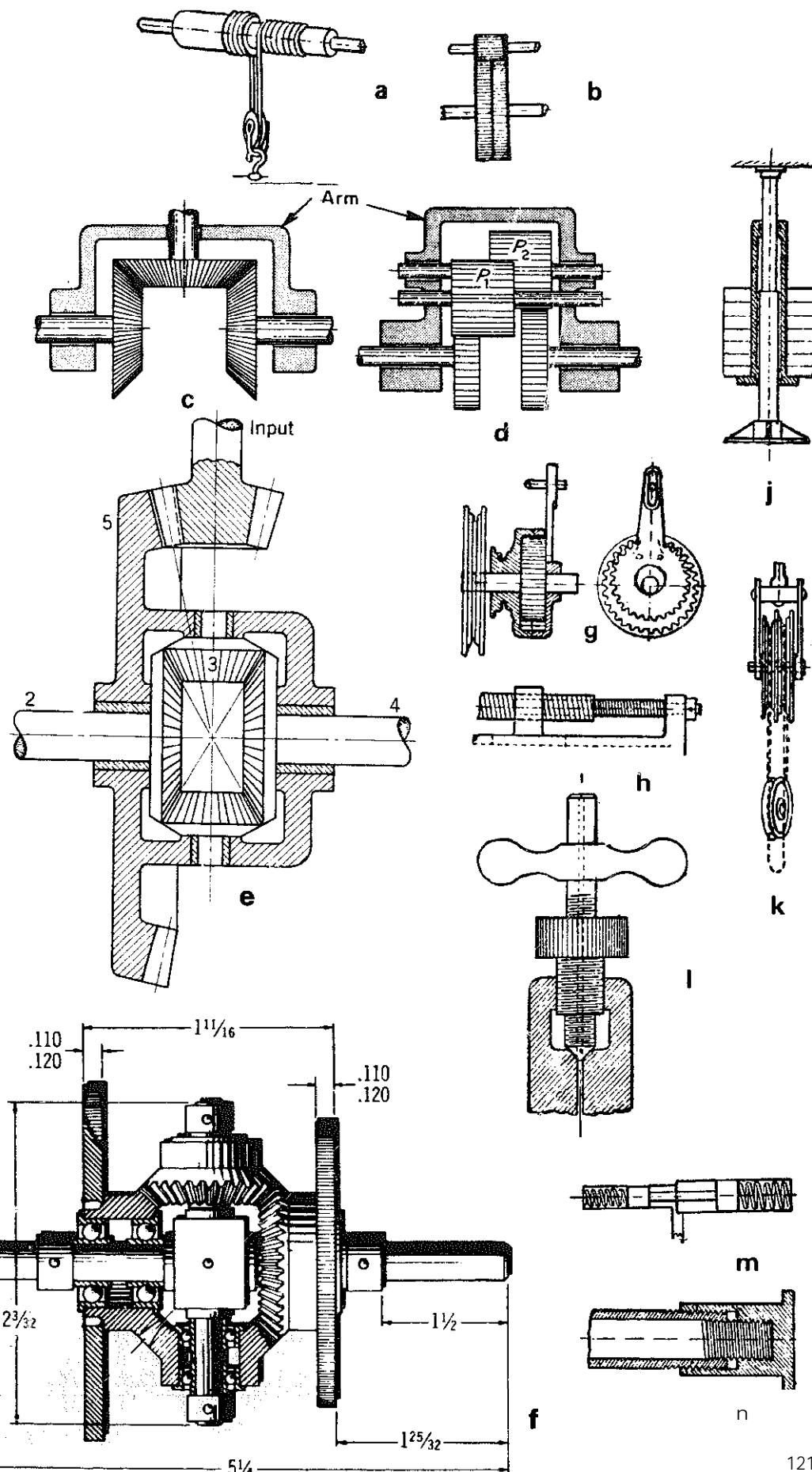

## D-Mechanisms and Kinematics

### 2--DIFFERENTIAL GEARING (cont)

**p--Planetary automotive** transmission of Ford model T. Planet carrier 2 is the input shaft and 27 tooth gear 6 is connected to the output shaft. For low forward speed gear 7 is locked by brake band B2. Brake band B1 locks gear 8 and puts car in reverse. For high speed clutch C engages input directly to output.

**q--Planetary gear train** of Buick Dycalflow Transmission. Torque converter gives most of the torque increase, but planetary gives low forward and reverse drive. Low range: Band B1 locks sun gear 6 to frame. Gear train consisting of gear 2 to 3, gear 3 to 4, and 4 to 6 are locked by gear 6. Band B2 when engaged locks ring gear 5 and the car is in reverse. In high, multiple disc clutch locking gear 6 to input shaft transmits torque without multiplication. (Buick Motor Div., General Motors Corp.)

**r--Harmonic drive.** Great speed reduction with increase in torque. A rigid internal tooth spline, meshes with the external teeth of flexible spline. An element called wave generator rotates within the flexible spline deflecting it so it meshes with the fixed spline, in two or more places.

**s--Harmonic drive.** Same as "r", except rollers replace elliptical cam.

**t--Planocentric drive.** Stationary internal tooth ring gear meshes rotating excentric input pinion. Output taken from pinion through a pin-coupling permitting radial displacement.

# DIFFERENTIAL GEARING

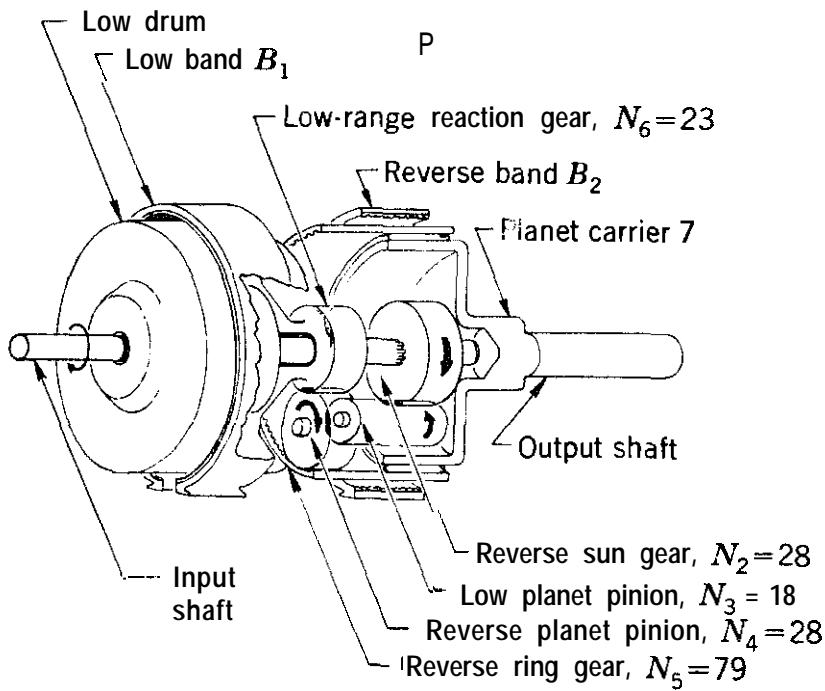
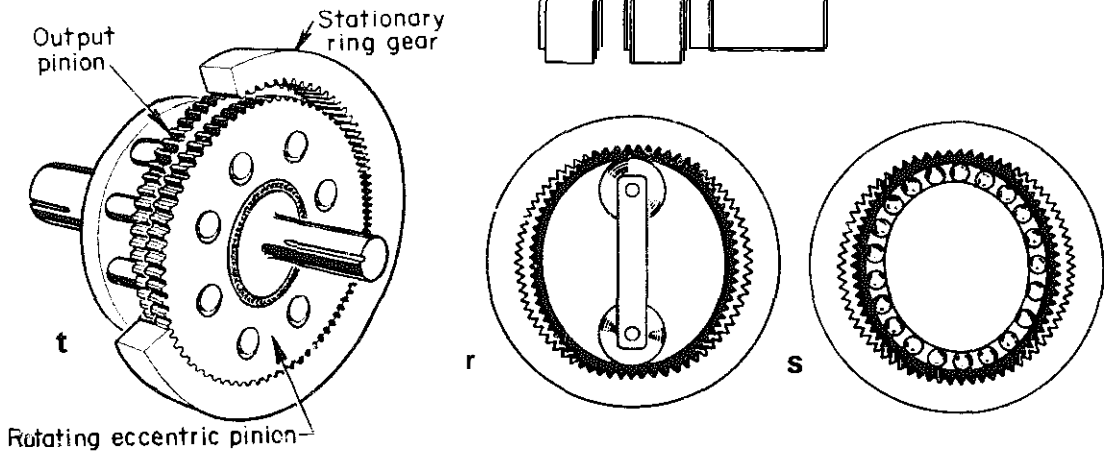
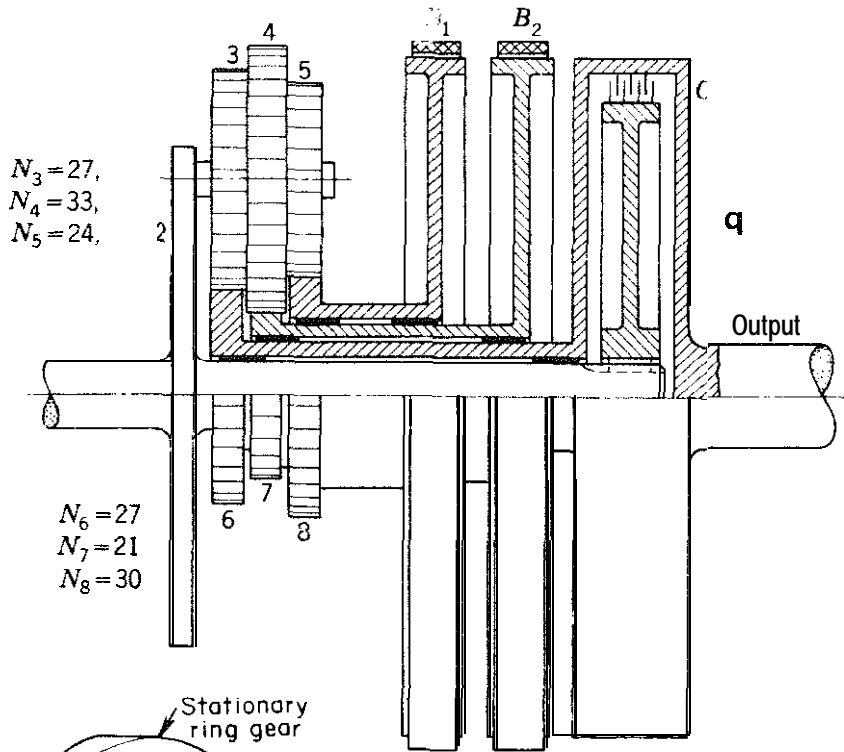

## D-Mechanics and Kinematics

### 3-VARIABLE MOTION DEVICES

**a-Variable-driving friction gear.** Position of friction rollers determines output speed.

**b-Variable radius crank.**

**c-Expanding V-belt pulley.**

**d-Belt speed cone device.**

**e-Four speed gear train.** Gears A,B,C slide together on a feather key or spline

**f-Six speed gear train.** Pinion on skewed shaft can be engaged to any one of the six bevel gears.

**g-Two-speed bevel gear** with four wheels and a sliding shaft.

**h-Two speed bevel gear** with three gears and a sliding shaft, whereby two of the gears can be put into gear.

**j-Elliptical spur gears** for variable motion.

**k-Three speed gear train** with separate clutch for each pair of gears.

**l-Four speed spur gear train** with sliding shaft and short key. Only gear engaged by key transmits power, the other three are idling.

**m-Four speed face gear.**

**n-Four speed gear train** with three shafts and three clutches. Gears **A** and **B** are the drivers.

**p-Principle of Planetary friction drive** using tapered rollers. Planet carrier is driven by motor directly. Planet elements (tapered roller and pinion) are rotated by contact with stationary control ring. Output speed depends on position of control ring and output speeds in both directions are obtainable. Contact pressure is maintained by centrifugal force of rollers.

**q-High speed position** of Reeves Beier drive. Power is transmitted by the viscous drag of thin oil films between driving and driven member, avoiding metal to metal contact. Rocker arms connected to a selector knob control movement of discs.



VARIABLE MOTION DEVICES

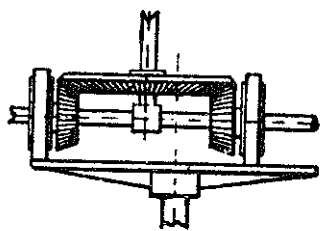

a

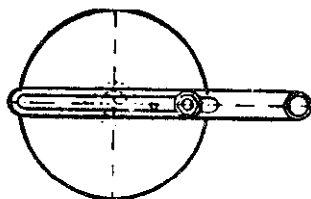

b

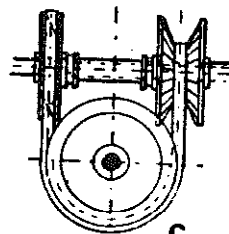

c

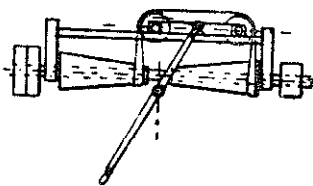

d

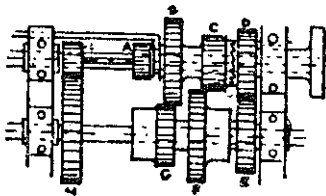

e

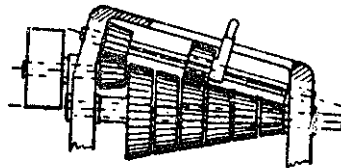

f

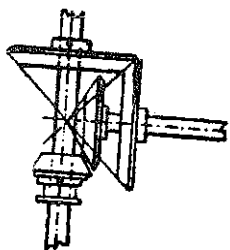

g

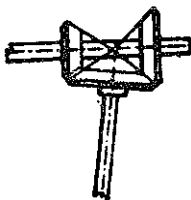

h

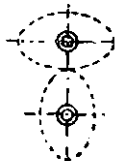

i

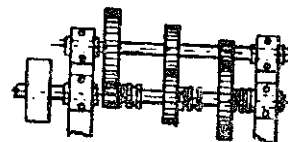

j

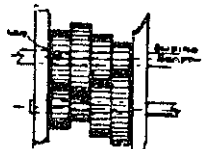

k

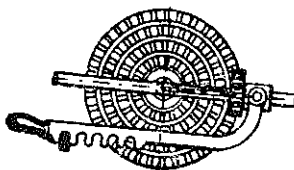

l

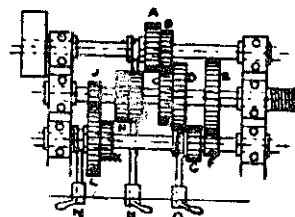

m

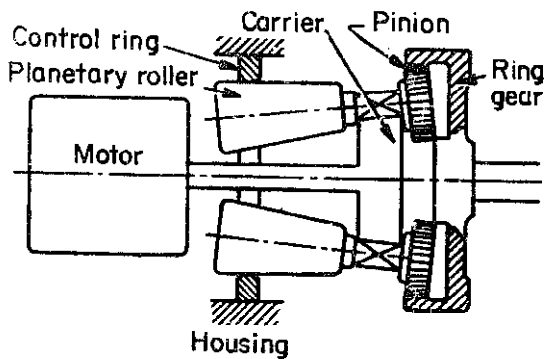

n

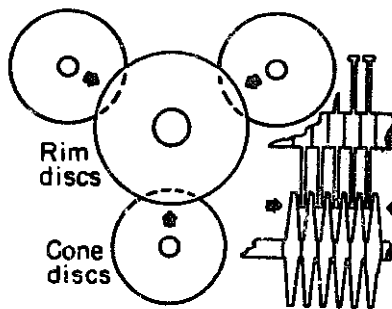

o

## D—Mechanisms and Kinematics

### 3—VARIABLE MOTION DEVICES (cont)

**r—Roller disc drive** miniature all-metal. The heart of this unit is two gimbal mounted rollers, transferring motion from input to output disc. Position of rollers determines output speed. Planetary gear at output adjusts output. (Metron instruments Inc.)

**s—Impulse drive**, Morse VID adjustable. Output: three intermediate gears mesh with gear on output shaft. Each of the three gears has a one-way clutch. On the input side linkages are oscillated by an eccentric cam. Pivot plate, controlled by worm determines the stroke.

**t—Adjustable impulse drive**, principle of Zero-Max. Drive operates through adjustable-stroke linkages, driving through one-way clutches. There is an eccentric for each linkage. Main links D pivot on I and J continue with “u”, without moving clutches, therefore zero output.

**u—Links transfer motion** with this setting to overrunning clutches F, driving the output shaft in one direction only, since the clutch free-wheels on the return stroke.

**v—Vari-pitch drive**, principle of the Rollguide. Inclination of the axes of the rollers acts like a screw thread and the housing moves.

**w—Torque converter**, typical single stage rotating housing. It consists of stator S, Turbine T, and impeller P. The engine driven impeller delivers kinetic energy to the fluid which rotates the turbine and leaves through the stator blades which redirects it to the impeller.

**x—Torque converter**, flow pattern at max load.

**y—Torque converter**, flow pattern at no load.

VARIABLE MOTION DEVICES

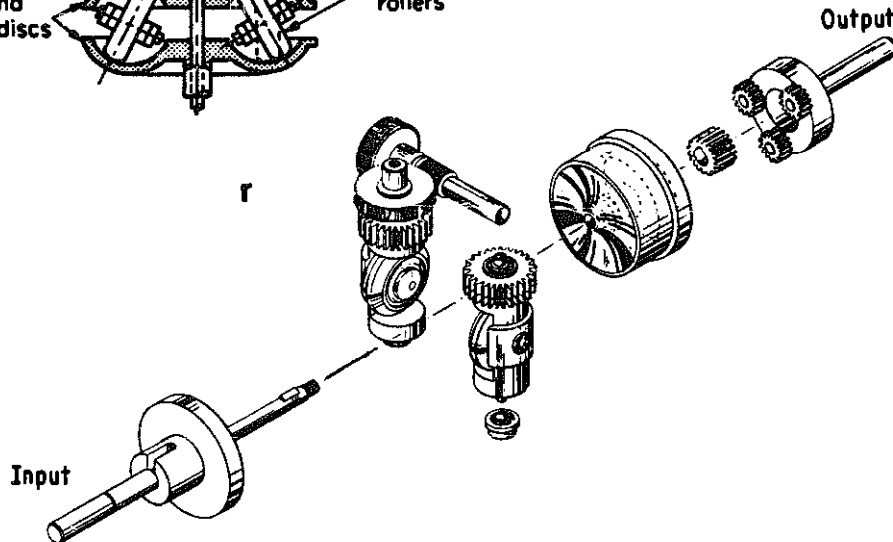
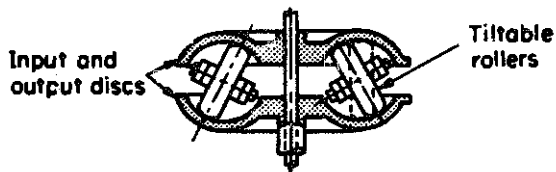
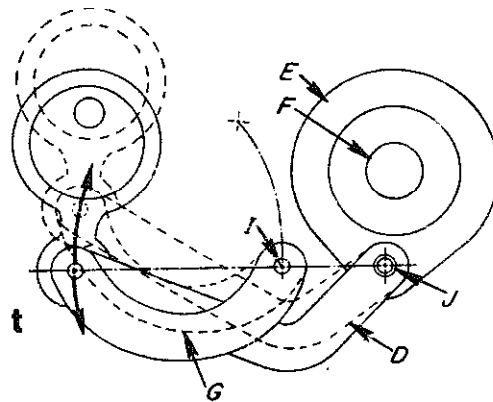
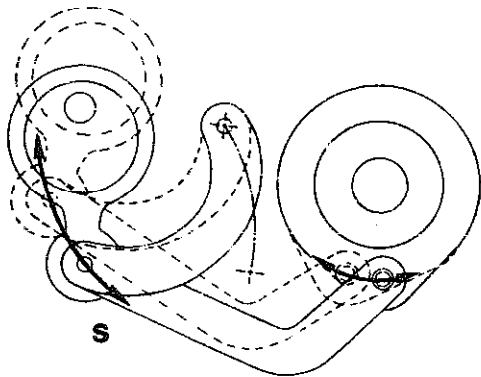
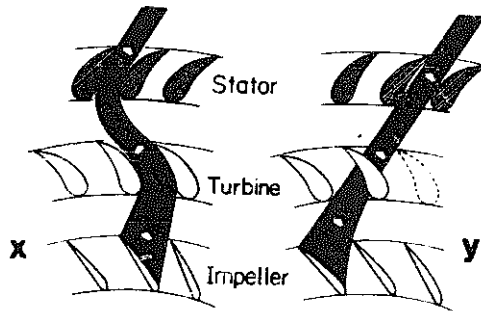
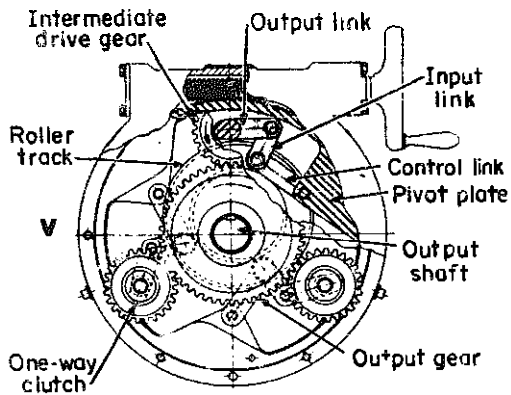
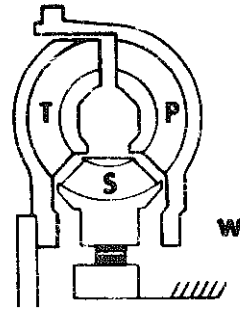
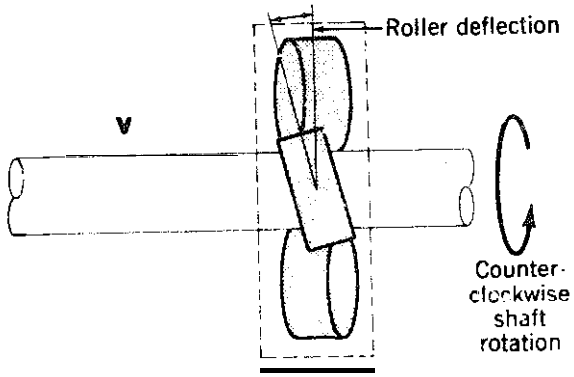

## D - Mechanisms and Kinematics

### 4-CIRCULAR AND RECIPROCATING MOTIONS

a-**Variable** reciprocating motion. Pin in rotating disc engages slotted bell crank.

b-**On - center slide crank.**

c-**Scotch yoke.** Output: pure harmonic motion.

d-**Reciprocating** motion of connecting rod through bell crank connected pin on crank disc.

e-**Rotating slotted crank.**

f-**Elliptical crank end motion.**

g-**Double crank.**

h-**Ball-jointed links.**

j-**Reciprocating wheel and crank motion.**

k-**Double piston crank motion.**

l-**Multiple trammel gear.** Pinion is half the diameter of the wheel. Pinion makes two revolutions to one of the wheel.

m-**Variable single acting pistons.**

n-**Variable crank pin** adjusted by sector and bolt.

p-**Excentric gears** deliver variable speed.

q-**Hydraulic, steam or pneumatic cylinder.**

r-**Sliding** motion for double cylinder by eccentric.

s-**Offset cross-head** and side-crank motion for an air compressor or pump.

t-**Whitworth** quick return motion.

u-**MacCord** quick return motion.

v-**Quick return motion.**

w-**Reciprocating motion** derived from circular motion.

x-**Friction gear.** Loose on stroke to left, grips on stroke to right.

y-**Reciprocating motion** from circular motion.

z-**Bent crank** and connecting rod.

CIRCULAR & RECIPROCATING MOTIONS

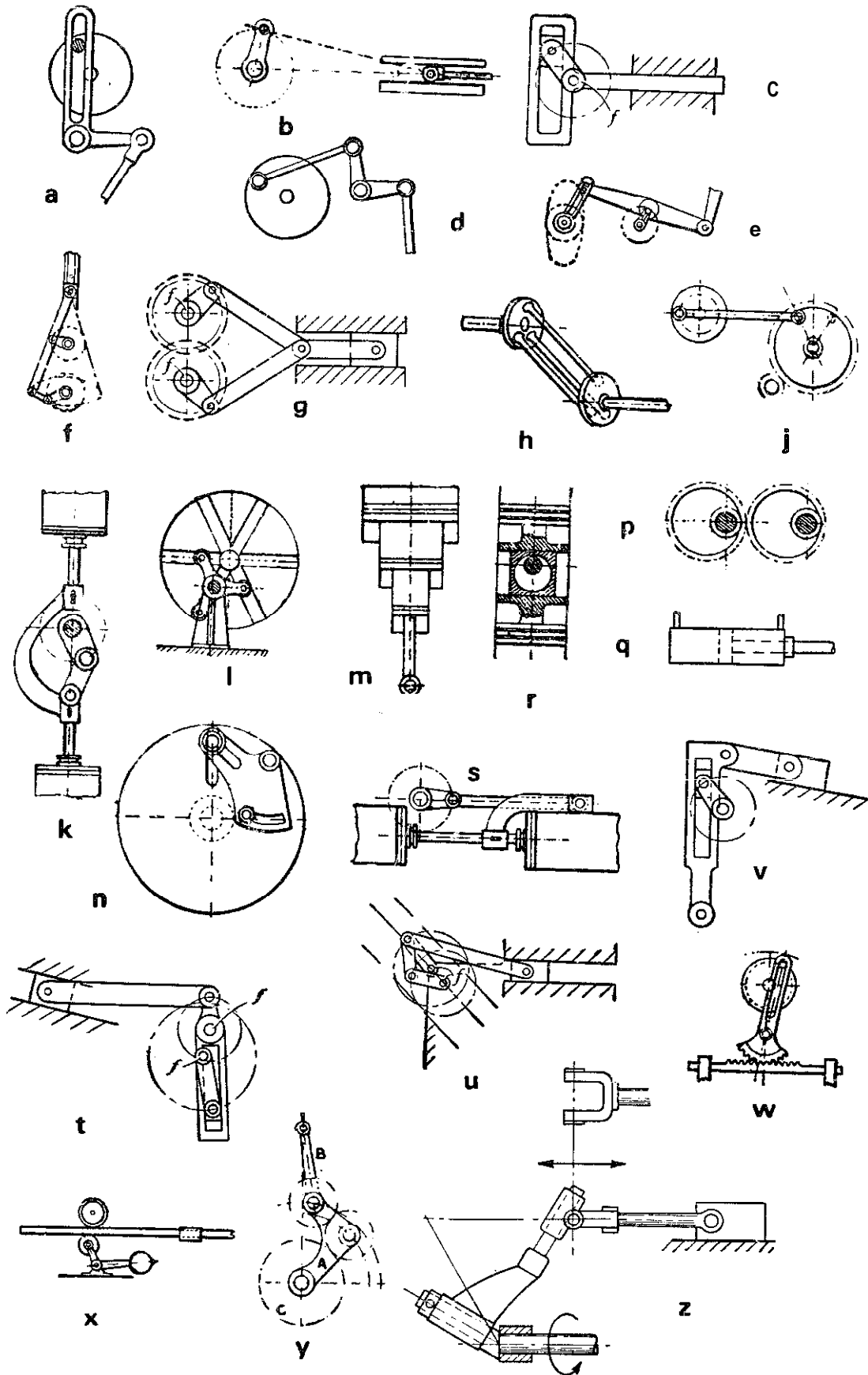

## D—Mechanisms and Kinematic.5

### 4-CIRCULAR AND RECIPROCATING MOTIONS (cont)

**aa—Bobbin winder.** Flyer revolves while bobbin moves up and down for even winding.

**ab—Variable rectilinear motion.** Oblique disc drives rod.

**ac—Off-axis slider crank.**

**ad—Rocking motion.**

**ae—Ovoid curve** made by point on member between crosshead pin 2nd crank pin.

**af—Crank and toggle.** Used in presses for its high mechanical advantage.

**ag—Reciprocating motion** from rotary motion with pause at end of each stroke

**ah—Double screw arrangement** for steering gear.

**aj—Pinion driving racks** and internal gear segments.

**ak—Transport mechanism.** Fingers of transport move load one step per revolution.

**al—Ball and socket crank** motion.

**am—Multiple return** cylinder.

**an—Continuous rotary motion** of shaft reciprocates slide.

**ap—Slot link and treadle.** Pinion is driven by friction on inside of slotted link.

**aq—Cone change speed device** using endless belt.

**ar—Variable fulcrum changes** lengths of stroke between driven and driving cylinder.

**as—Variable radius lever.**

**at—Grooved cam traverse** mechanism.

# CIRCULAR & RECIPROCATING MOTIONS

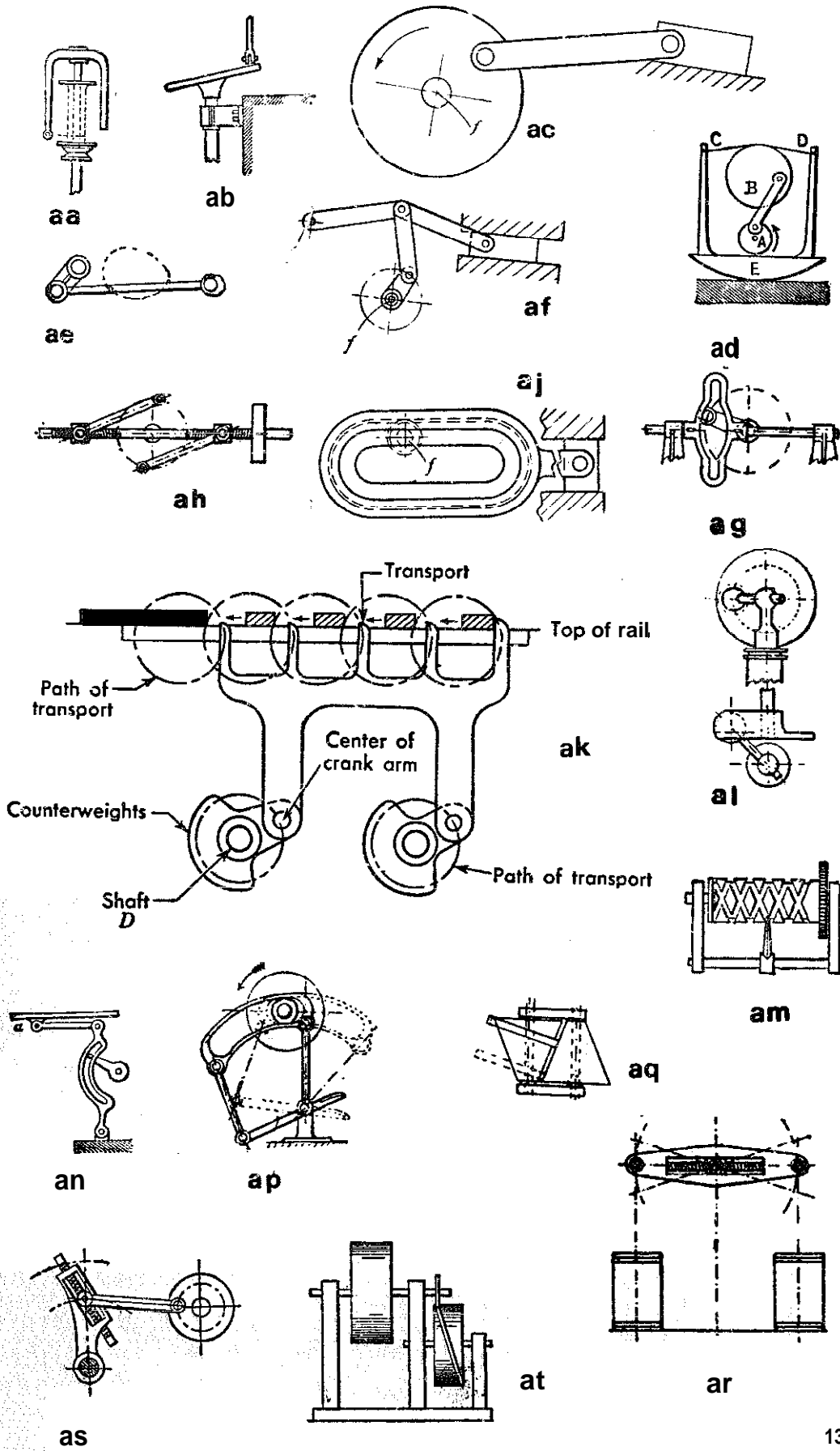

## D-Mechanisms and Kinematics

### 5—GEAR AND BELT SHIFTING

**a—Leather-belt shifter.** When the belt is shifted from the loose pulley L to the tight pulley F pulley C revolves and drives lathe. To stop, belt is shifted back to loose pulley L by pulling D.

**b—Lever in dead center** both belts are on loose pulleys. Shifting lever to right gives one speed, to left another speed.

**c—Stepped** cone gear with four speeds. showing belt tightener a.

**d—Reversing pulley.**

**e—Four speed change gear.** Hollow spindle has change gears running loose on it. Lever C engages key A in one of the gears, locking gear to spindle.

**f—Gear shifter.**

**g—Shifter,** throwing friction clutch in and out of gear.

**h—Reversing gear** from a single belt and cone shift lever:

**j,k,l,m,—Manual belt reversing** shift gear.

**n—Stop, drive and reverse motion** with single belt. Gear A is fastened to shaft a, Gear B to hollow shaft B. Center pulley runs free, while pulleys a and b are fastened to shafts a and b.



# GEAR & BELT SHIFTING

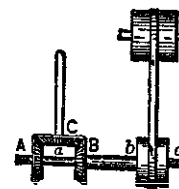
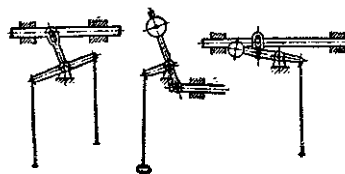
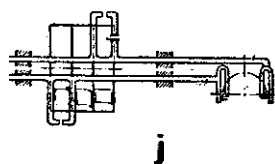
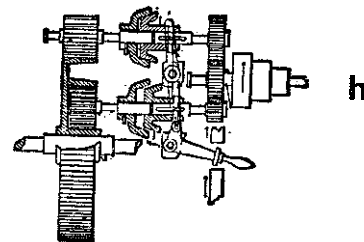
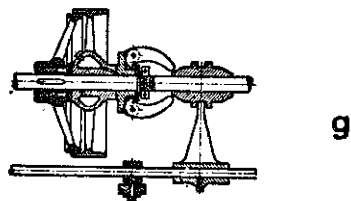
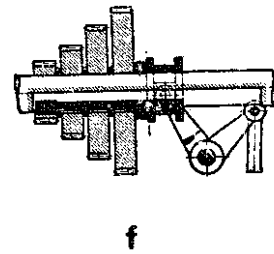
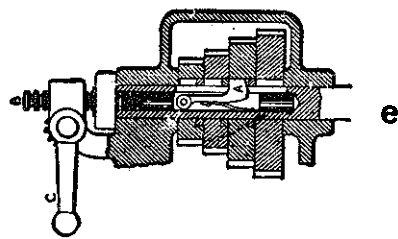
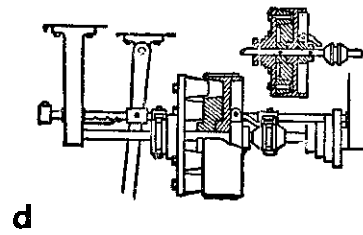
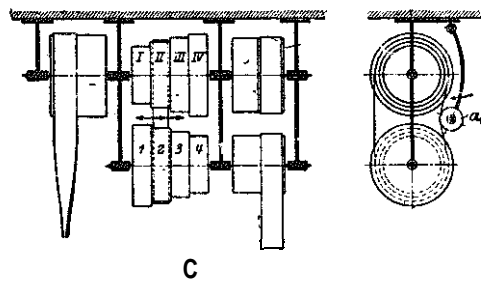
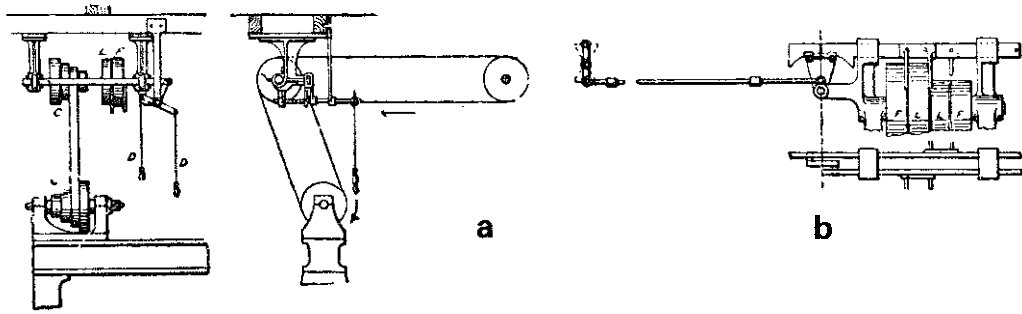

## D—Mechanisms and Kinematics

### S-GEAR AND BELT SHIFTING (cont)

**p—Driving gear** is loose on shaft and locked to it by hand-wheelnut or ratchet and pawl.

**q—Radius bar and slot** permits adjusting of gearing centers. Gear may be moved in and out of gear.

**r—Shaft** runs in eccentric bearings which can be revolved, throwing gear out of gear.

**s—Sliding back-shaft** disengages gears.

**t—Bolt and slot device** to clamp two gears on same shaft. Used on lathe headstocks.

**u—Adjustable belt-shift bar.**

**v—Cam slot arrangement** for back shaft to engage or disengage gear.

**w—Slackening belt** by means of eccentric.

**x—Sliding shaft** slides pinion out of gear.

**y—Sliding shaft** method, locks shaft in or out of gear.

**z,aa,ab—Gear and wheel puller.**

**ac—Chain gear puller,** Herkimer's.

**ad—Two half nuts** are lifted in or out of gear with a screw by cam or lever action.

**ae—Revolving worm** for operating a belt shifting bar and locking it at the same time.

**af—Gearshift** brought about by applying brake bands. Output dependent on which gears are locked and which are free to turn.

GEAR & BELT SHIFTING

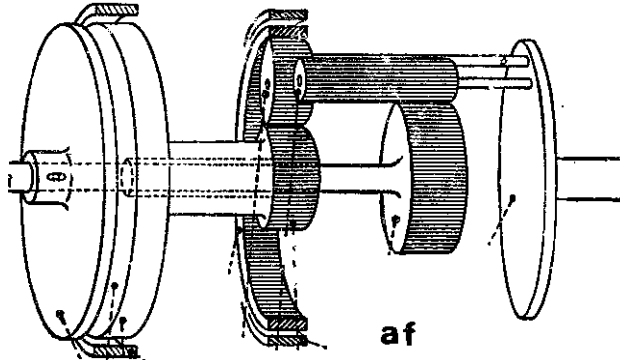
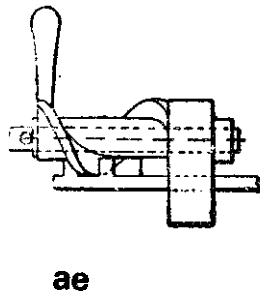
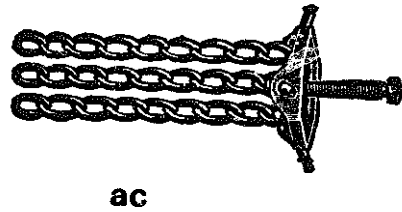
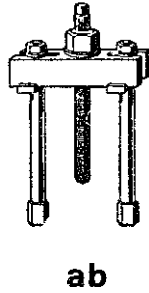
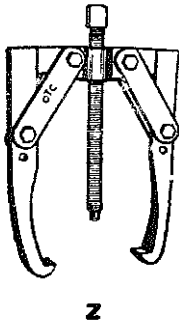
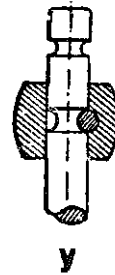
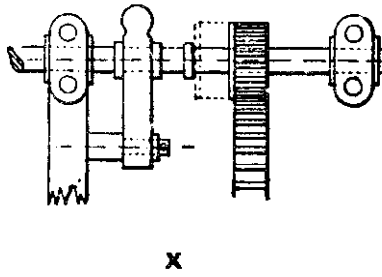
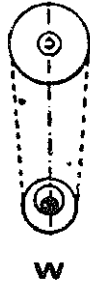
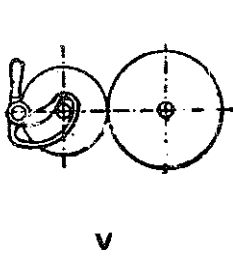
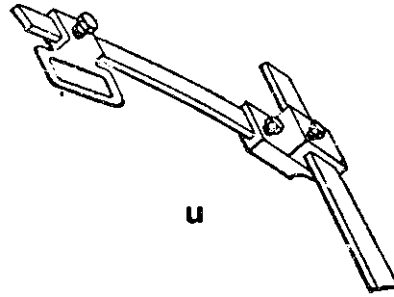
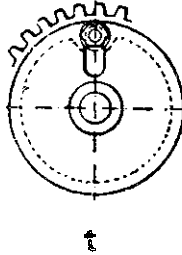
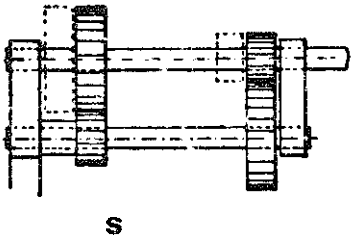
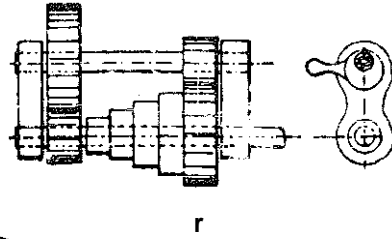
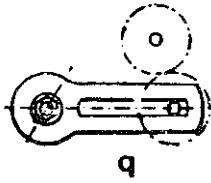
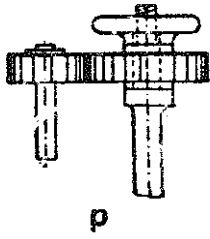

## D—Mechanisms and Kinematics

### 6—CLOCK AND WATCH MECHANISMS

**a—Centrifugal pendulum;** the weight is driven in a circle by the clock movement.

**b—Cycloidal pendulum movement.**

**c—Compound compensation pendulum.** Upper part of arms made of steel, lower part of brass. When temperature rises, pendulum get longer, but weights are lifted higher, due to higher temperature coefficient of brass.

**d—Compensating pendulum weight.** Weight filled with mercury. When pendulum lengthens due to temperature, the mercury expands more to compensate for it.

**e—Compensating watch balance.**

**f—Anchor escapement** in clocks.

**g—Antique clock escapement.** (Verge escapement)

**h—Star-wheel escapement.**

**j—Dead-beat clock escapement.**

**k—Recoil escapement.**

**l—Lantern wheel escapement.**

**m—Crown tooth escapement with ball balance.**

**n—Pin wheel escapement** with a dead beat stop motion. Used on certain pendulum clocks.

**p—Three-toothed escapement.** A nearly dead beat movement where long teeth A and B are pallets. D and E are stops.

**q—Stud escapement,** for large clocks.

**r—Endless cord winding device.**

**s—Pendulum escapement.**

**t—Lever escapement** of the single roller type.

**u—Sections of plate and balance jewels.**

**v—Incablock shock absorber,** fitted to balance staff jewel holes. From top to bottom: spring which holds jewel setting and endstone in place. Endstone, jewel hole, brass collet in which jewel hole is set, block fitted into balance cock, staff.

CLOCK & WATCH MECHANISMS

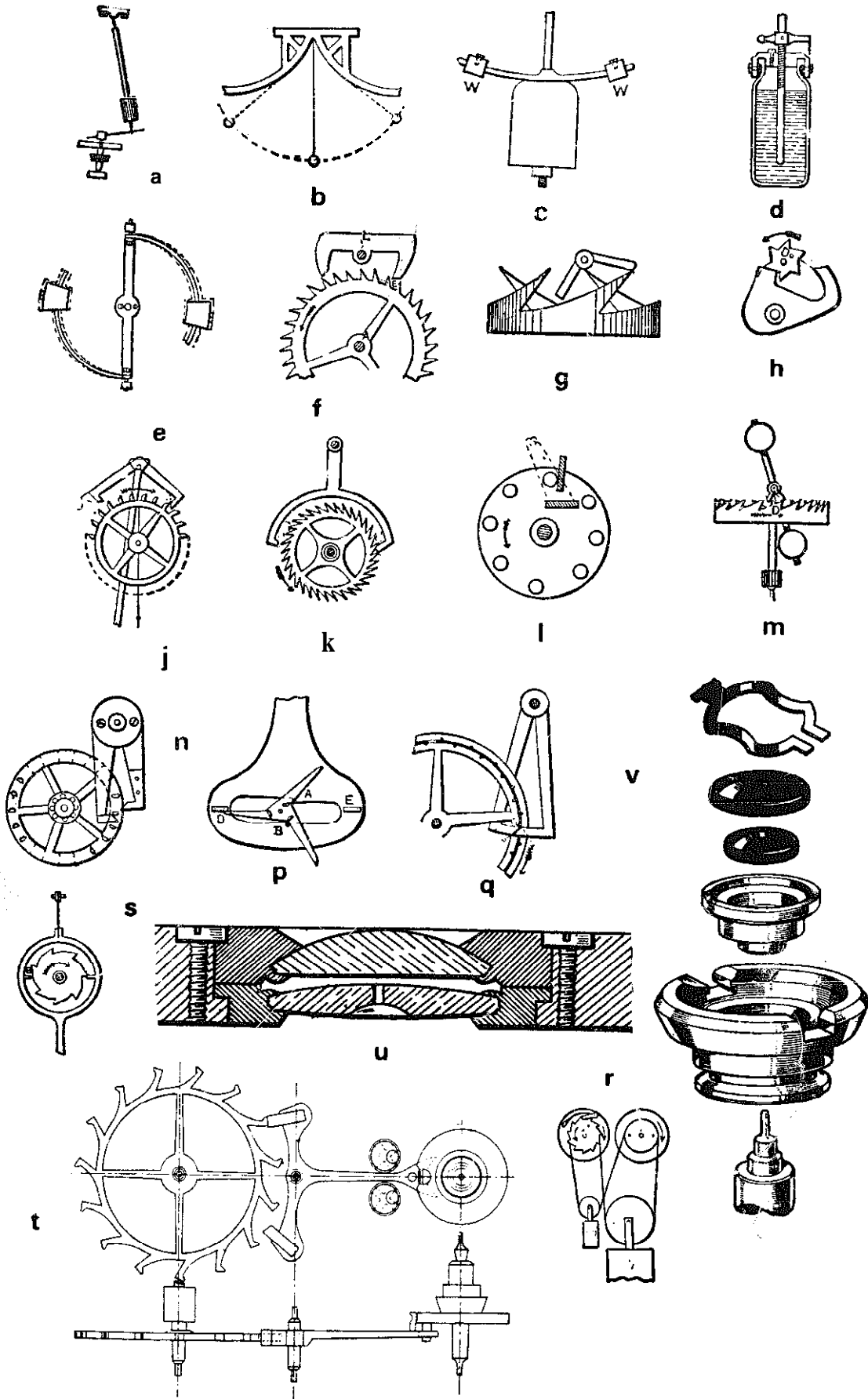

D—Mechanisms and Kinematics

6-CLOCK AND WATCH MECHANISMS (cont)

w—Verge escapement.

x—Duplex escapement.

y—Lever escapement.

z—Guernsey escapement.

aa—Regulator.

ab—Anchor and lever escapement.

ac—Arnold chronometer escapement.

ad—Geneva stop. A winding stop used on watches. It winds as many turns of the wheel A as there are notches in the wheel B, less one. The curve a-b is the stop.

ae—Watch stop.

af—Pin geared watch stop.

ag—Geared stop watch. Contact of the two arms makes the stop.

ah—Chronometer escapement.

aj—Lever chronometer escapement.

ak—Double three-tooth gravity escapement.

al—Clock train.

am—Fusee chain and spring drum. Changing diameter on spiral drum gives spring constant torque throughout its range.

an—Watch train. keystone a, barrel spring, and spur gear b, pinions c,e,g,i; spurwheels d,b; pallets and escapements 1,1; lever and balance wheel k.

CLOCK & WATCH MECHANISMS



w

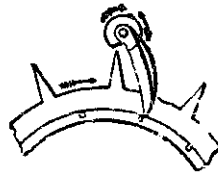

x

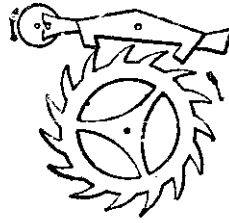

y

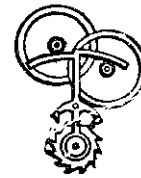

z

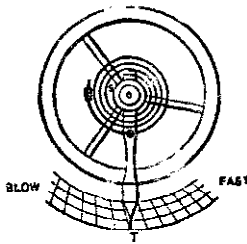

aa



ab

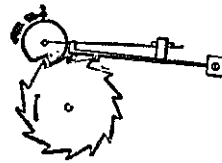

ac



ad

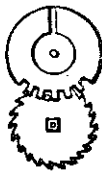

ae



af

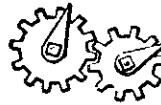

ag

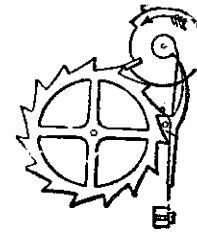

ah

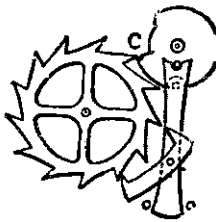

aj

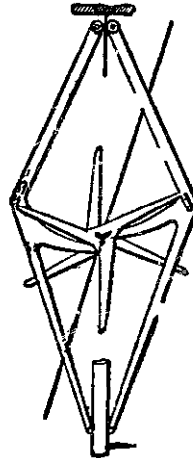

ak

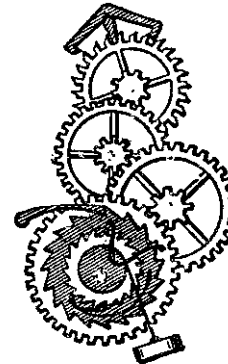

al

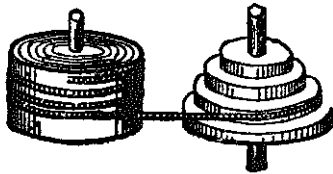

am

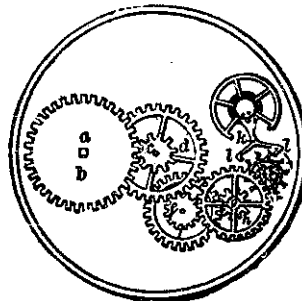

an

D—Mechanisms and Kinematics

7—KINEMATIC MECHANISMS

a—Link.

b—Slider crank chain.

c—Chain variations:

c1—Fixing **AC** gives direct-acting engine.

c2—Fixing **BC** gives oscillating engine and quick return.

c3—Fixing **AB** gives Whitworth's quick return.

c4—Fixing block C gives Stannah's penulum pump.

c5—Fixing **AC** and prolonging **CB** to twice its length ( $CB = 2AC$ )

Scott-Russell's straight-line motion, **D** making a straight line.

) gives



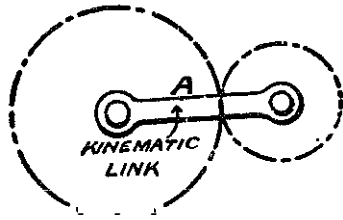

a

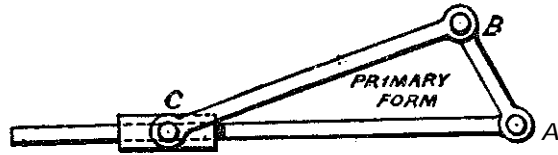

b

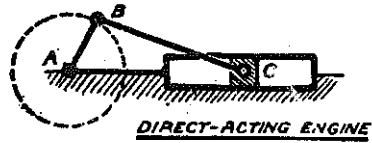

c1

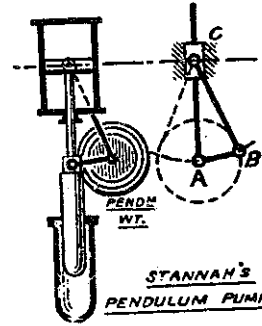

c4

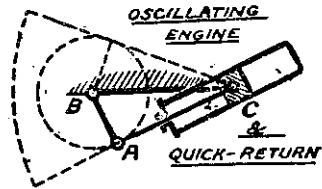

c2

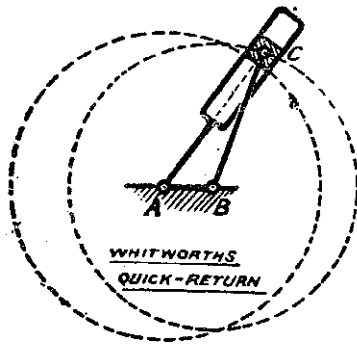

c3

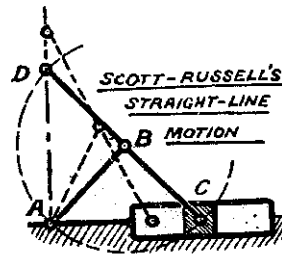

c5

## D—Mechanisms and Kinematics

### 7—KINEMATIC MECHANISMS (cont)

**d—Double slider crank** chain. Has three links, two turning pairs and two sliding pairs variously connected. As shown, with link AC fixed, it is known as the “Scotch yoke”.

d1—Fixing AC we have a combination used formerly to connect a pump to a steam cylinder. Also the donkey-pump mechanism.

d2—Fixing AB and AC at right angles and moving a turning pair to C gives elliptic trammels, oval chuck and Oldsham’s coupling.

d3—Fixing AB and AC at right angles and putting one turning pair at C, two sliding and one turning pair at B give **Rapson’s Slide**; This results in an increased leverage as the **tiller** is moved over hard.

**e—Four link mechanism.** Has four links and four turning pairs.

e1—**Watts parallel motion.** Fixing AB makes AC equal to BD.

e2—Fixing AB gives a beam engine with link closure by flywheel lever crank pin.

e3—Fixing AB and making opposite links equal give wheel coupling gears for locomotives with closure by double chain. (Parallel-crank chain).

e4—Same as three, but altering lengths gives special motion; used in wire rope manufacture to preserve vertical position of drums (parallel crank chain).

e5—Same as “3” but doubling the chain as shown gives Roberval’s balance allowing the weight to be placed anywhere on the pan.

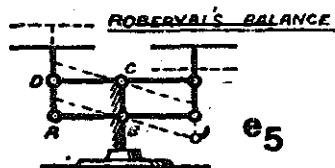
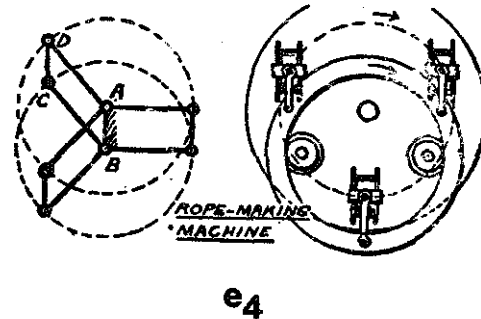
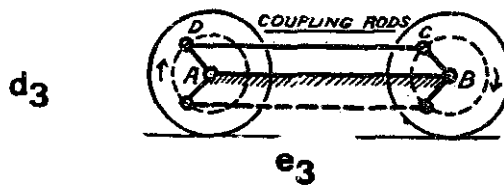
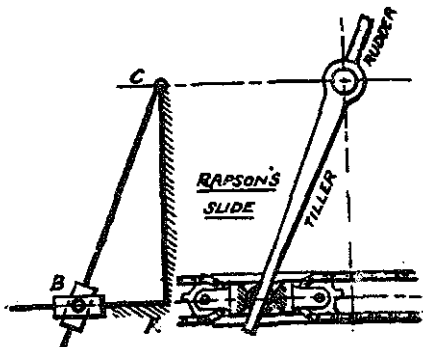
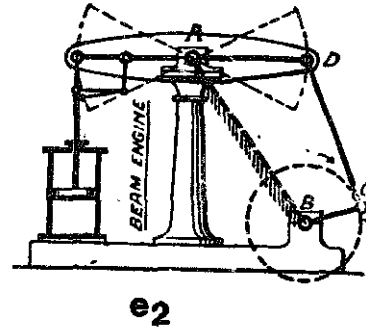
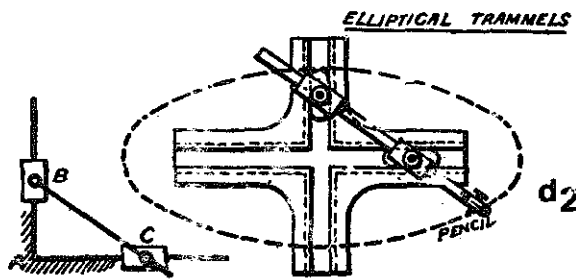
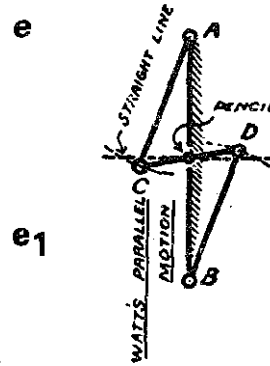
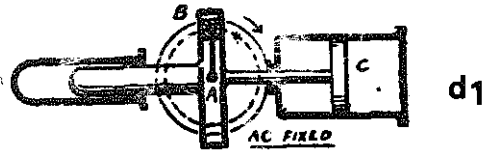
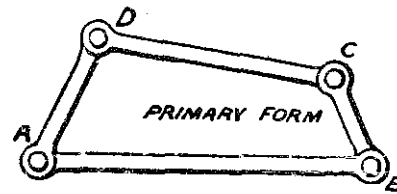
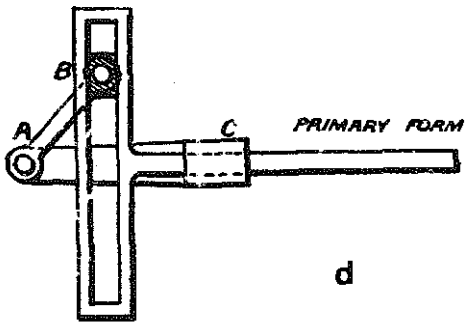

## D—Mechanisms and Kinematics

### 8—CAM MECHANISMS

**a,b,c,—Heart** cams for giving regular or intermittent motion to a follower.

**d—Crown** cam for vertical shaft.

**e—Eight-lobed disc** cam.

**f—Three lobed disc** cam.

**g—Heart shaped face** cam.

**h—Cylindrical** cam.

**j—Lever** cam.

**k—Twisted bar** with sliding bushing causing bar to turn.

**l—Cam plate and levers** with rocking motion; can impart any intermittent or variable motion to a follower.

**m—Cam lever motion** from a reciprocating rod to give irregular motion to another rod.

**n—Crank pin and slotted** lever give quick return motion.

**p—Spiral** cam.

**q—Compound** cam for operating radial arms.

**r—Internal compound** cam for operating radial slides.

# CAM MECHANISMS

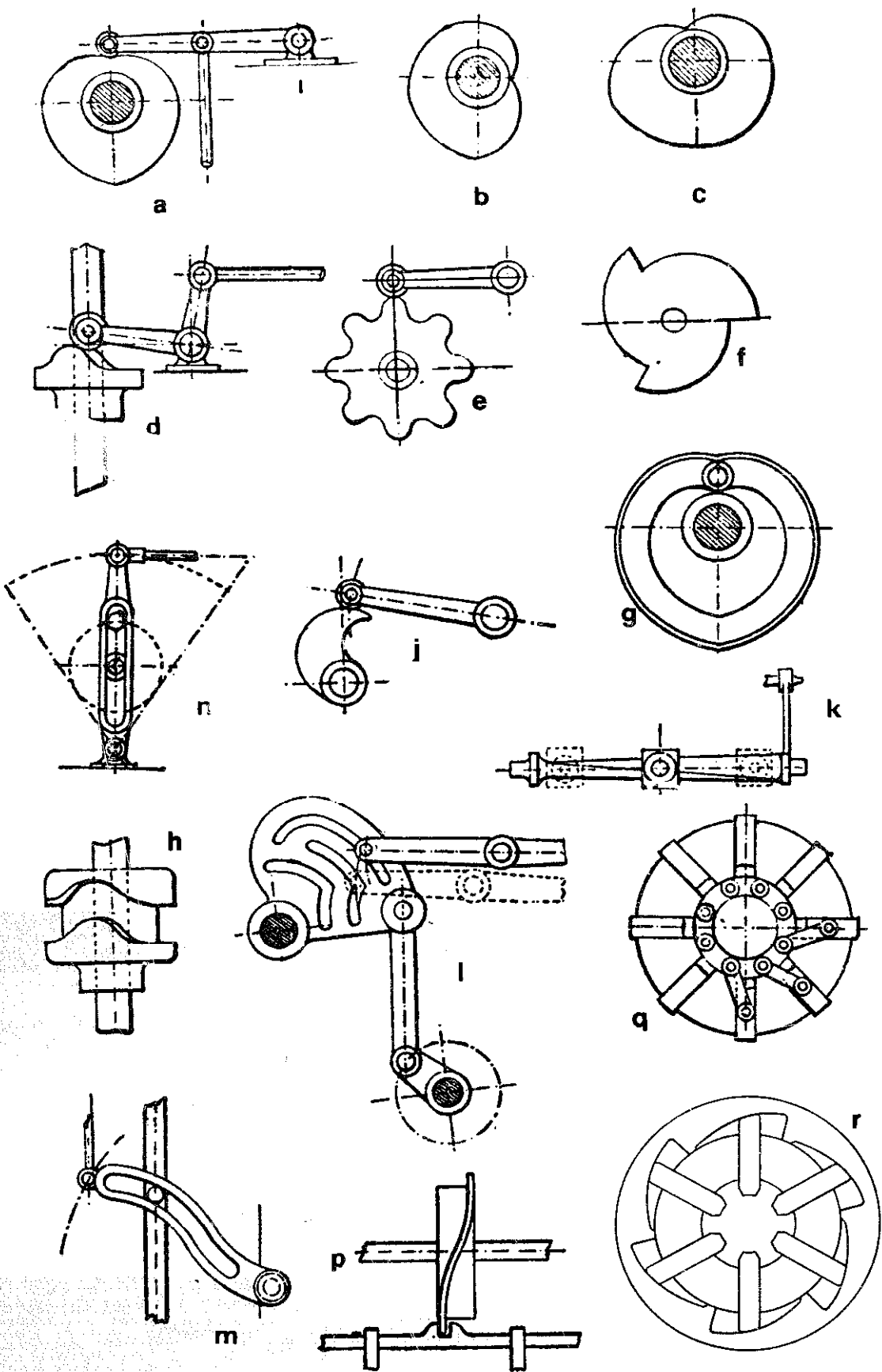

**D—Mechanisms and Kinematics**

**8—CAM MECHANISMS (cont)**

**s—Spherical cam** with oscillating follower.

**t—Modified Scotch yoke**, to get uniform reciprocating motion from uniform crank motion.

**u—Three dimensional space cam.**

**v—Cam application.** Three followers driven by one cam.

**w—Vibrating rectilinear motion** from revolving **three-lobed cam.**

**x—Irregular vibrating circular motion** from **face cam.**

**y—Wiper cam** for stamp mill.

**z—Double cam motion** from sliding follower.

**aa—Cam slot** in lever to disengage gears.

**ab—Cam sectors** of logarithmic spiral wheels; the sum of the lengths of every pair of coincident radii is always equal to the distance of centers from each other.

**ac—Power escapement** for machines.

**ad—Cylindrical cam.**

**ae—Reciprocating rectilinear motion.**

**af—Bell crank toe levers.**

**ag—Cam-lever grip** for rod or rope stop; this principle is used on safety catches for elevators.

**ah—Cam operated shears.**

**aj—Rotary motion** of a three-arm wiper produces **reciprocating motion.**

**ak—Equalizing levers** or toes for variable rod movement.

CAM MECHANISMS

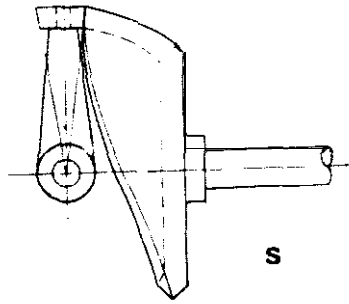

s

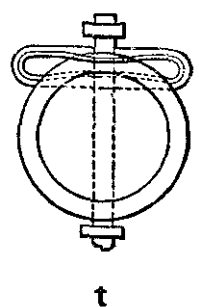

t

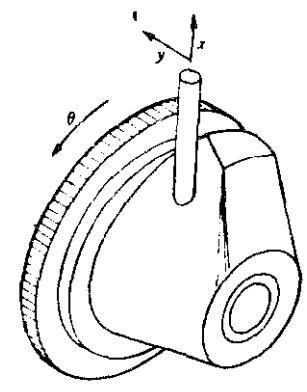

u

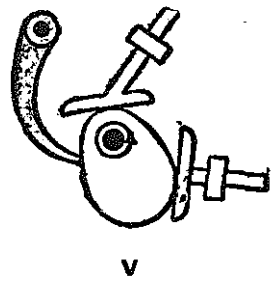

v

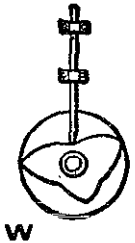

w

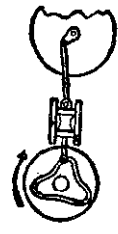

x

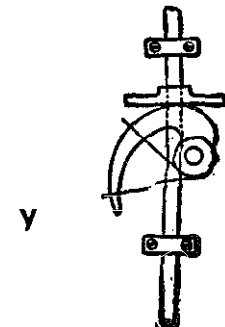

y

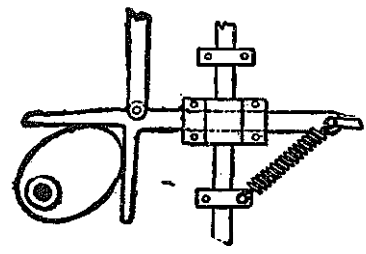

z

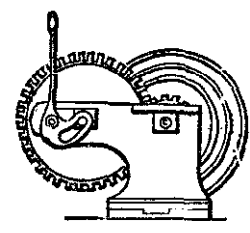

aa

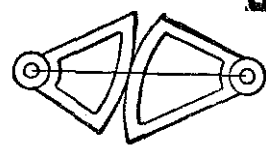

ab

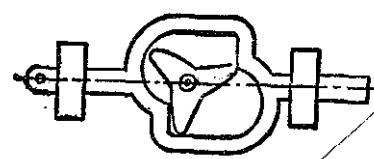

ac

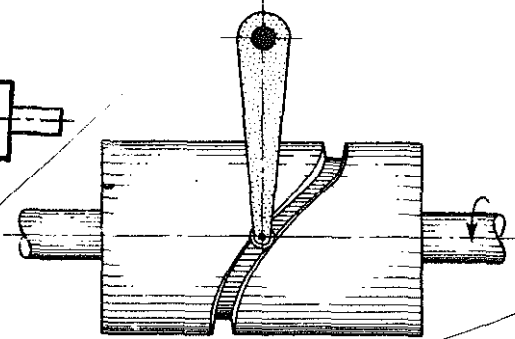

ad

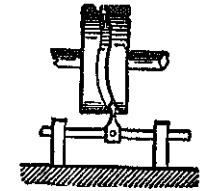

ae

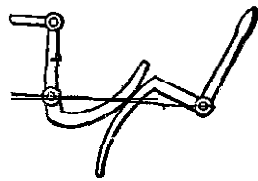

af

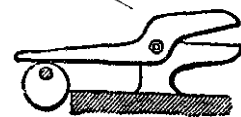

ah

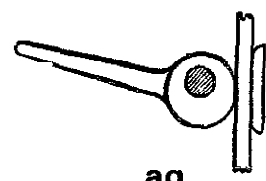

ag

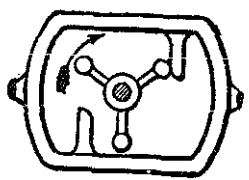

aj

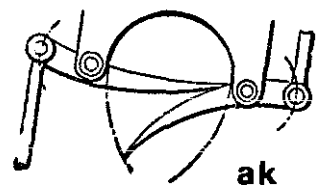

ak

## D—Mechanisms and Kinematics

### S-CAM MECHANISMS (cont)

**al**—**Triangular curved eccentric** with a stop at each half revolution.

**am**—**Yoke strap and eccentric circular cam.**

**an**—**Needle-bar** slot cam for sewing machines; the depression in the pin slot gives the needle a stop while the shuttle passes.

**ap**—**Eccentric and slotted** arm; the pin at the top of the arm has both a vertical and horizontal motion, causing it to trace an ellipse; the pin on which the slot runs is fixed.

**aq**—**Swash plate** with two different followers,

**ar**—**Translation** cam, with one-way positive action

**as**—**Automotive** cam with flat-faced mushroom follower.

**at**—**Toe—and wiper** cam.

**au**—**Constant breadth** cam.

**av**—**Multiple face** cam with three followers.

**aw**—Spiral radius bar for opening a valve **which** is lifted off its seat by the radial motion of the lever against the inclined radius bar.

**ax**—**Diagonal disc** cam, giving a rocking movement to the crosshead and shaft.



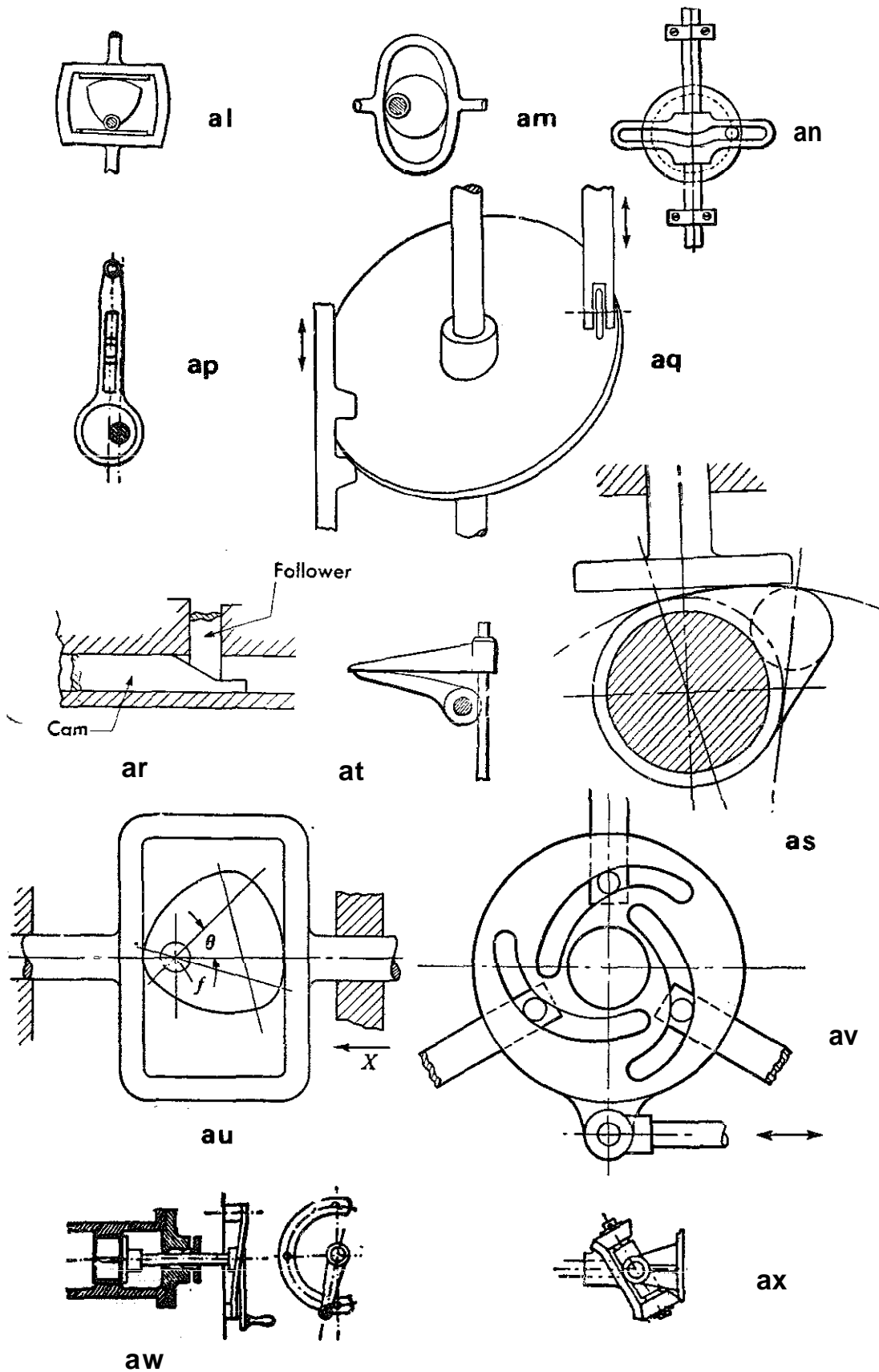

## D-Mechanisms and Kinematics

### 8-CAM MECHANISMS (cont)

**ay**—**Translation** cam with double positive action.

**az**—**Double disc positive action** cam.

**ba**—**Ferguson indexing** drive. Cycloidal base curve used as cam follower drive.

**bb**—**Beveled disc** cam for imparting variable reciprocating motion to a bar at an angle to a shaft

**bc**—**Multiple revolution** cam.

**bd**—**Triangular eccentric**.

**be**—**Irregular reciprocating** motion.

**bf**—**Double end** cam.

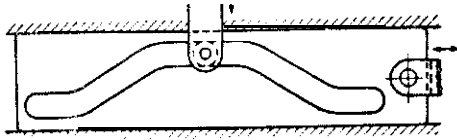

ay

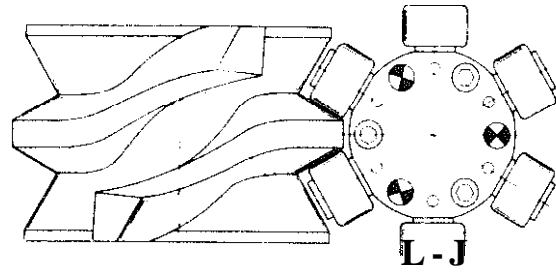

ba

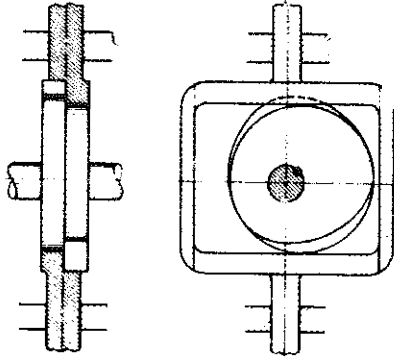

az

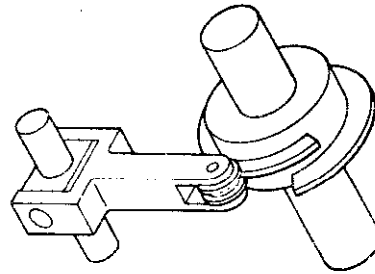

bc

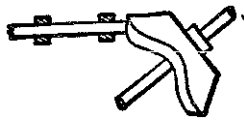

bb

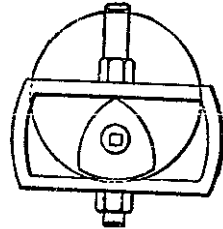

bd

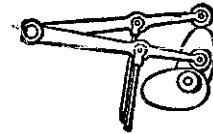

be



bf

## D-Mechanisms and Kinematics

### 9-PARALLEL AND STRAIGHT LINE MOTION

a-Drafting machine.

b-Parallel rule.

c-Peaucellier straight line mechanism. Requirements to be an exact straight line. Link 2 must equal  $AB$ . Links 3 and 4 must be equal. Links 5, 6, 7, and 8 must be equal.

d-Sector and rack motion.

e-Floating tables, move freely in any direction. Two tables on rollers at 90°.

f-Parallel opening doors.

g-Beam with rocking fulcrum.  $A$  and  $A$  being equal.

h-Parallel motion for hammers, or similar applications.

j-Parallel motion for an indicator, the approximate proportions being  $c:d = d:b$ .

k-Cartwright's parallel motion; invented in 1787; both gears  $C$  are equal, also the two cranks  $A$ ; the piston rod  $B$  moves in a straight line.

l-Epicycloidal parallel motion; the pinion is one-half the diameter of the wheel at the pitch circle; the crank pin is fixed on the pitch circle of the pinion; the piston rod moves in a straight line; a curiosity of ancient engineering.

m-Parallel motion for an indicator pencil.

n-Multiple grinding fixture using parallel motion.

PARALLEL & STRAIGHT LINE MOTION

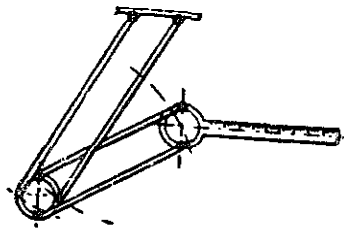

a

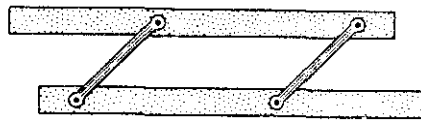

b

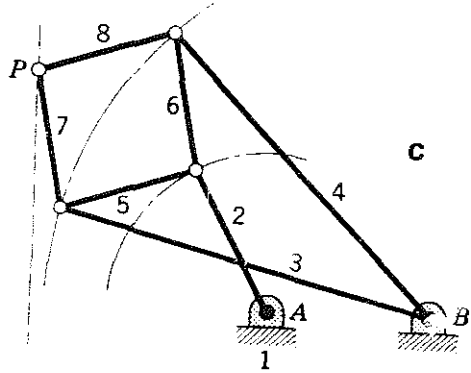

c

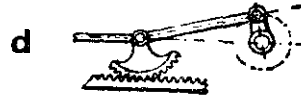

d

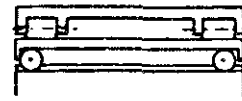

e



f

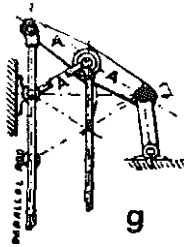

g

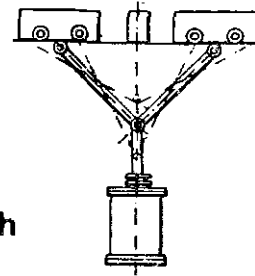

h

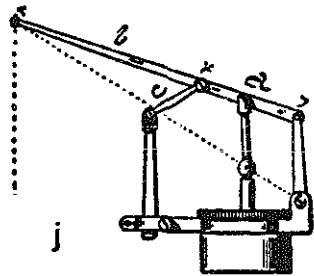

j

k

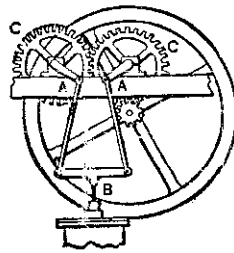

l

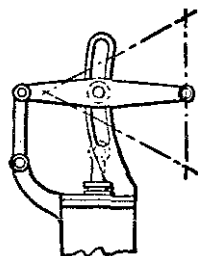
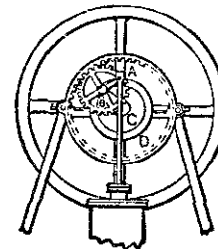

m

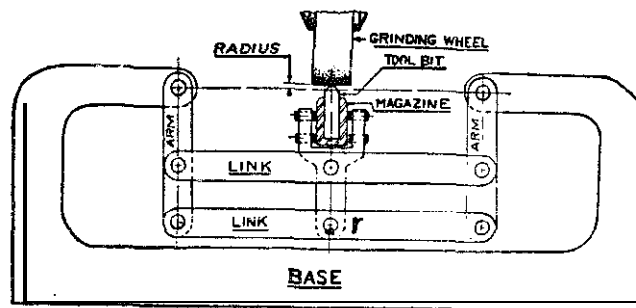

n

D—Mechanisms and Kinematics

9—PARALLEL AND STRAIGHT MOTION (cont)

p—Parallel motion of pistons; pistons are double pivoted at equal distances from the central pivot of the handle.

q—Parallel steering wheel.

r—Double-link balance scale.

s—Parallel motion;  $S$  and  $P$  are fixed points vertically while  $L$  and  $M$  move horizontally parallel to fixed points  $S$  and  $P$ ; links  $SL$  and  $PM$  are equal to  $BO$ ; links  $LB$  and  $LM$  are of equal length, so are links  $SL$  and  $PM$ .

t—Duplex air pump; the crank moves the common joint of the long arm horizontally on a slide; the shortening of the toggle greatly increases the compression during the early part of the stroke when it is most required.

u—Beam with rocking arm;  $AE$  and  $AB$  are equal when  $E$  is located on the center line of the piston rod;  $BC$  equals  $BE$ .

v—Three-horse whiffletrees; the second pair has the center pins at two-thirds of their length from the inner end; the center single tree is attached with loose links.

w—Pivoted steps for a gangway or accommodation ladder; the steps are always level.

x—Watt straight line motion.

y—Pantograph.

z—Drafting machine.

aa—Press right and left hand nuts and connecting rod lower platen.

ab—Marine engine, simple parallel motion.

ac—Parallel motion;  $a$  equals  $b$ ,  $c$  equals  $d$  equals  $e$ .

ad—Parallel motion;  $a$  equals  $b$ ,  $c$  equals  $d$ ,  $e$  is a crosshead.

ae—Parallel motion;  $c$  equals  $d$ ,  $e$  equals  $c$ ,  $b$  equals half of  $a$ .

af, ag—Parallel motion with cords, used on drafting machines.

PARALLEL & STRAIGHT LINE MOTION

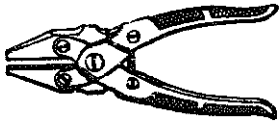

p

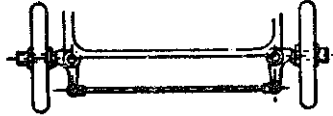

q

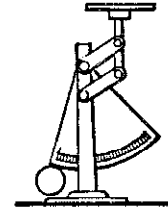

r

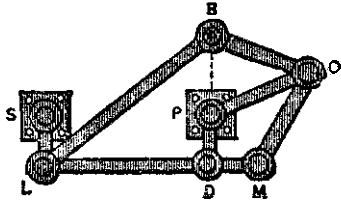

s

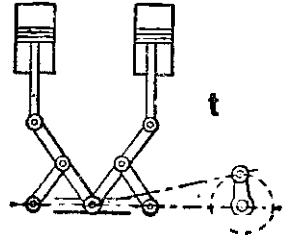

t

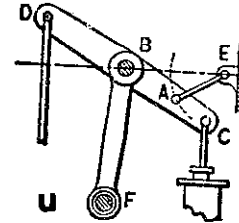

u

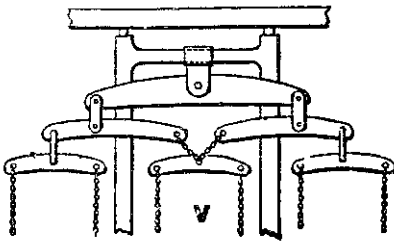

v

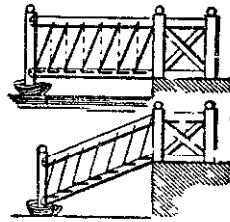

w

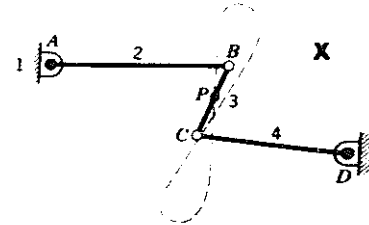

x

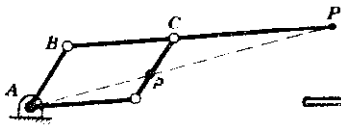

y

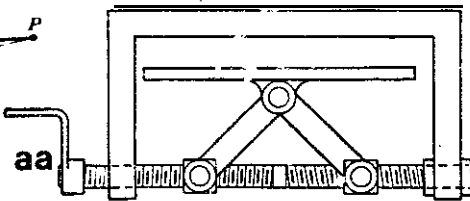

aa

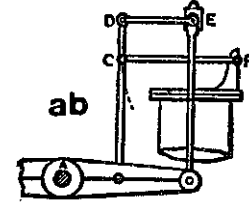

ab

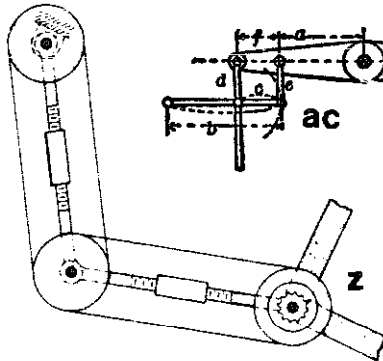

z

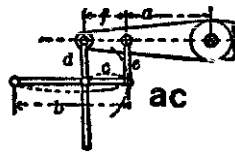

ac

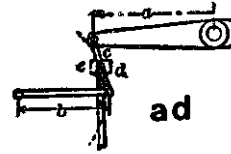

ad

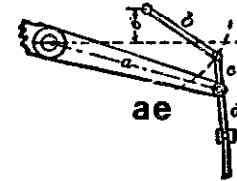

ae

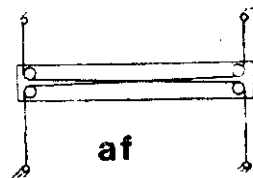

af

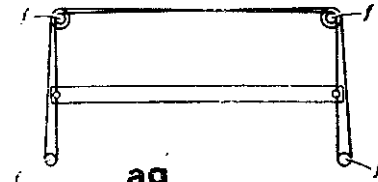

ag

## D-Mechanisms and Kinematics

### IO-ENERGY CONVERTING MECHANISMS

**a**—**Inclined plane**;  $W \times \text{sine of angle} + \text{friction} = P$ .

**b**—**Inclined plane**; horizontal push,  $P = W \times h \div b$ .

**c**—**Wedge**; strain = force  $\times 1 \div W$ .

**d**—**Screw**;  $P = W \times \text{pitch} \times 2 \times r \times 3.1416$ .

**e**—**Worm gear**;  $P = W \times \text{pitch} \times r \div 6.28 \times r \times R$  ( $W \div 2$ , if the screw thread is double).

**f**—**Differential axle**;  $P = W \times (a-b) \div 2 r$ .

**g**—**Differential windlass**; the sheave and hook rise to a height equal to half the difference in the circumference of the barrels for each turn of the crank; forefather of the differential pulley.

**h**—**Differential shaft derrick**; the bucket can be raised above the mouth of a pit or shaft.

**j**—**Steam-hoisting engine**, with reversing link.

**k**—**Spanish windlass**.

**l**—**Jack screw**.

**m**—**Light-weight hoist**.

**n**—**Capstan**.

**o**—**Steering gear** for a boat.

**p**—**Winding engine** with gear.



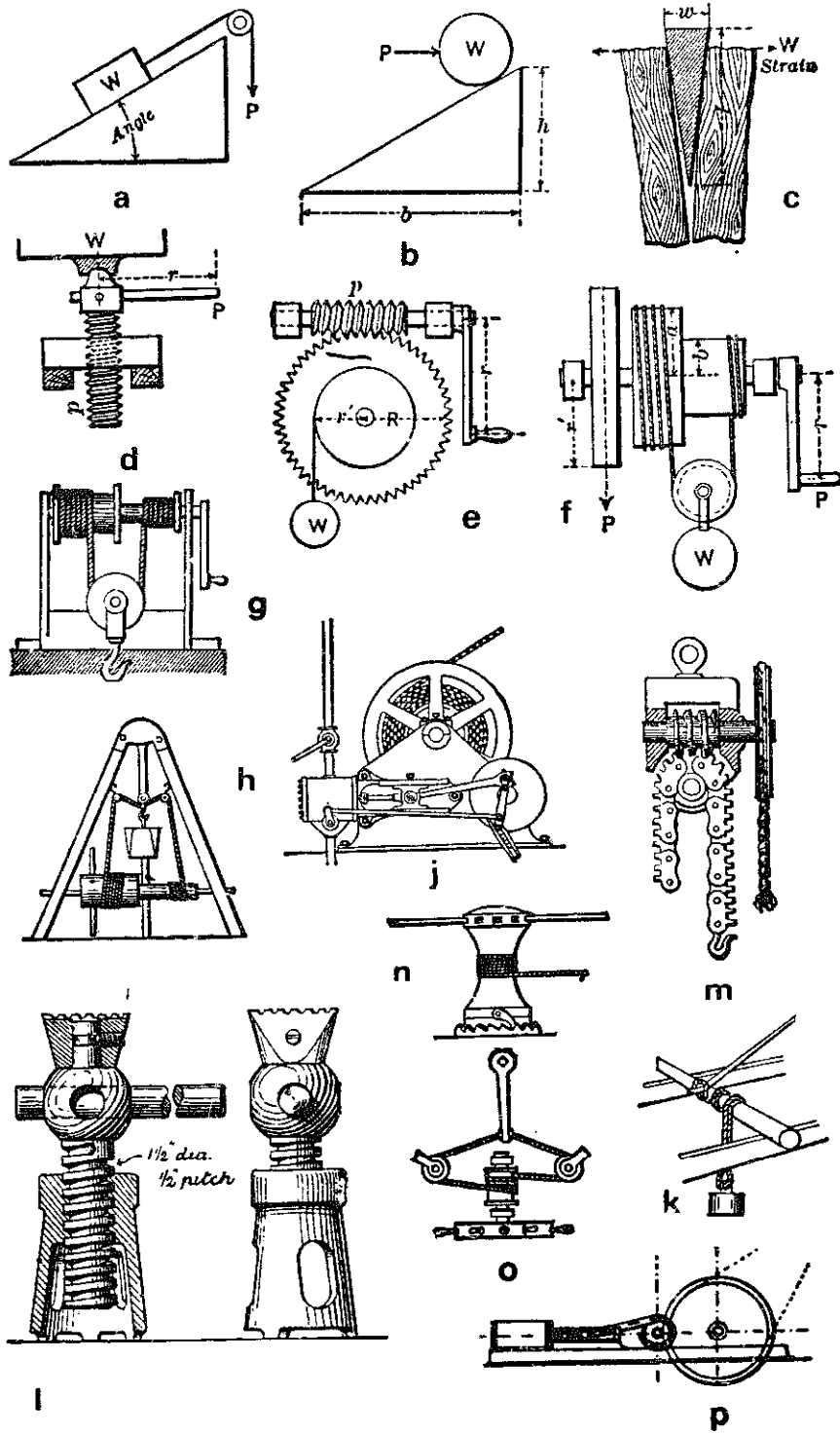

**D-Mechanisms and Kinematics**

10-ENERGY CONVERTING MECHANISMS (cont)

q-Compound lever.

r-Double toothed cam and lever combination.

s-Double lever and link motion with increasing pressure.

t-Lever and toggle motion.

u-Compound-lever shears.

v-Lever and frame gear for great multiplying leverage, and detent to prevent slipping back.

w-Compound-lever cutting shears.

x-Stake puller.

y-Hydraulic press.

z-Portable riveter; the large piston and lever give great power.

aa-Lever toggle joint used in stamping presses.

ab-Screw stamping press.

ac-Double-screw toggle press.

ad-Single-toggle-arm letter press.

ae-Toggle-joint stone breaker.

af-Lewis' wedge for lifting stone.

ag-Toggle-joint stone breaker.

al-Weston differential gear hoist.

aj-Toggle-bar press; the toggle bars have spherical ends.

ak-Sector press.

al-Adjustable grip tongs.

am-Lever grip tongs.

an-Compound tire-upsetting and punching machine.

ap-Screw jack.

aq-Letter press with Stanhope levers.

ar-Toggle-joint wagon brake.

as-Rack and lever jack.

at-Hydraulic jack.

ENERGY CONVERTING MECHANISMS

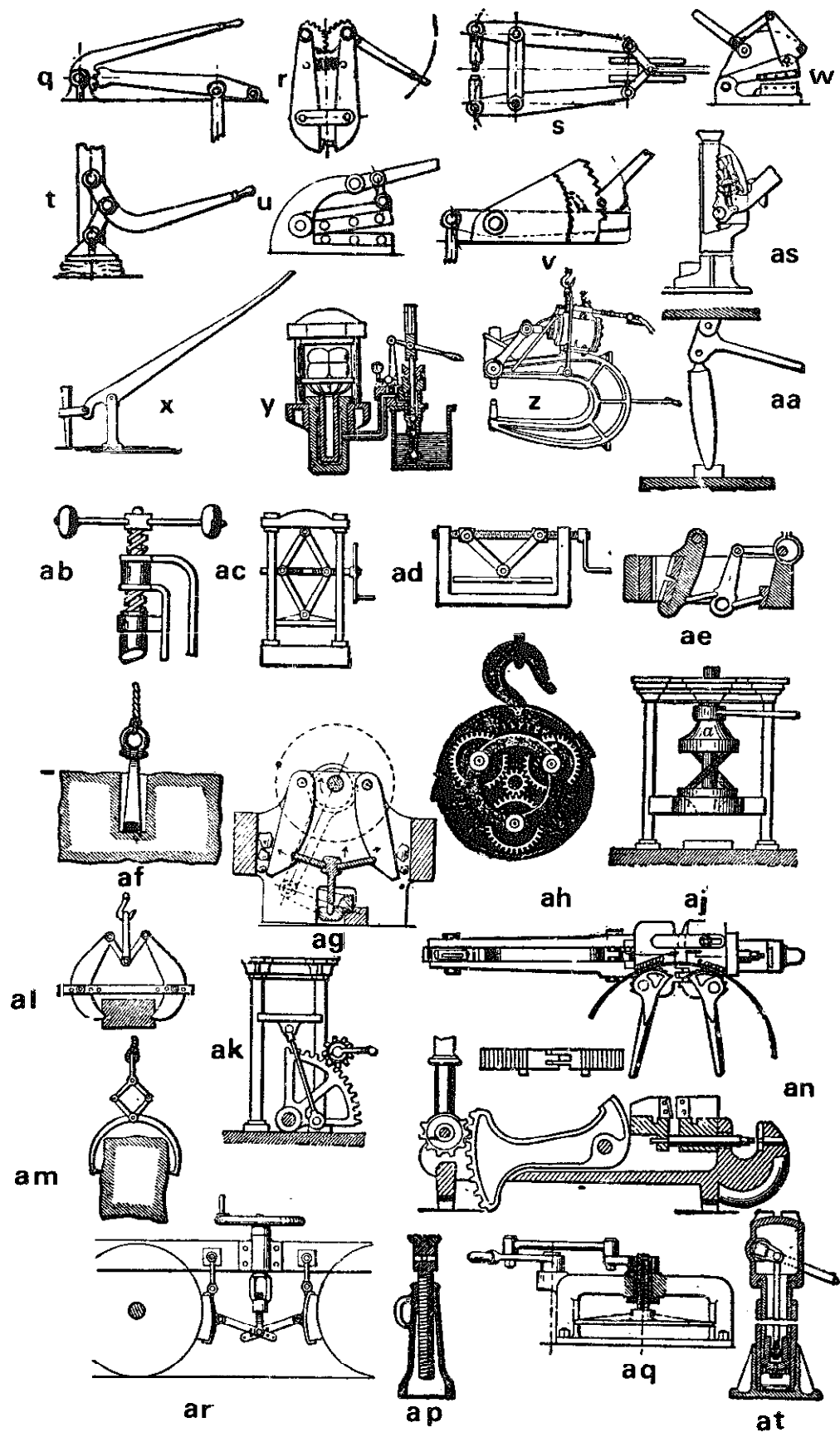

**D—Mechanisms and Kinematics**

11 —ADJUSTING DEVICES

**a—Adjustable rod** or lever.

**b—Adjustable arm.**

**c—Adjustment for tension** or compression of a torsion spring; the arm is split and locked to the spindle by a screw.

**d—Adjustment of bearings** for chain or belt gear.

**e—Split joint** for taking up wear.

**f—Adjustable stays.**

**g—Adjustable turbine jet.**

**h,j—Adjustable table** or base.

**k—Slotted link** and lock nut for adjusting the angle of a lever.

**l—Disc and ring** with partial angular adjustment by a screw and nut; used for self-centering chucks; the nut and bearing of the screw have allowance for swiveling.

**m—Pin and hole adjustment** for a lever.

**n—Wedge bearing** for locomotive horn-plate guides, slide bars and similar parts subject to wear.

**o—Right- and left-hand screw and wedge** adjustments for roller bearings.

**p—Adjustment of engine crossheads** for taking up wear on working faces.

**q—Adjustable floor-stand shaft bearing.**

ADJUSTING DEVICES

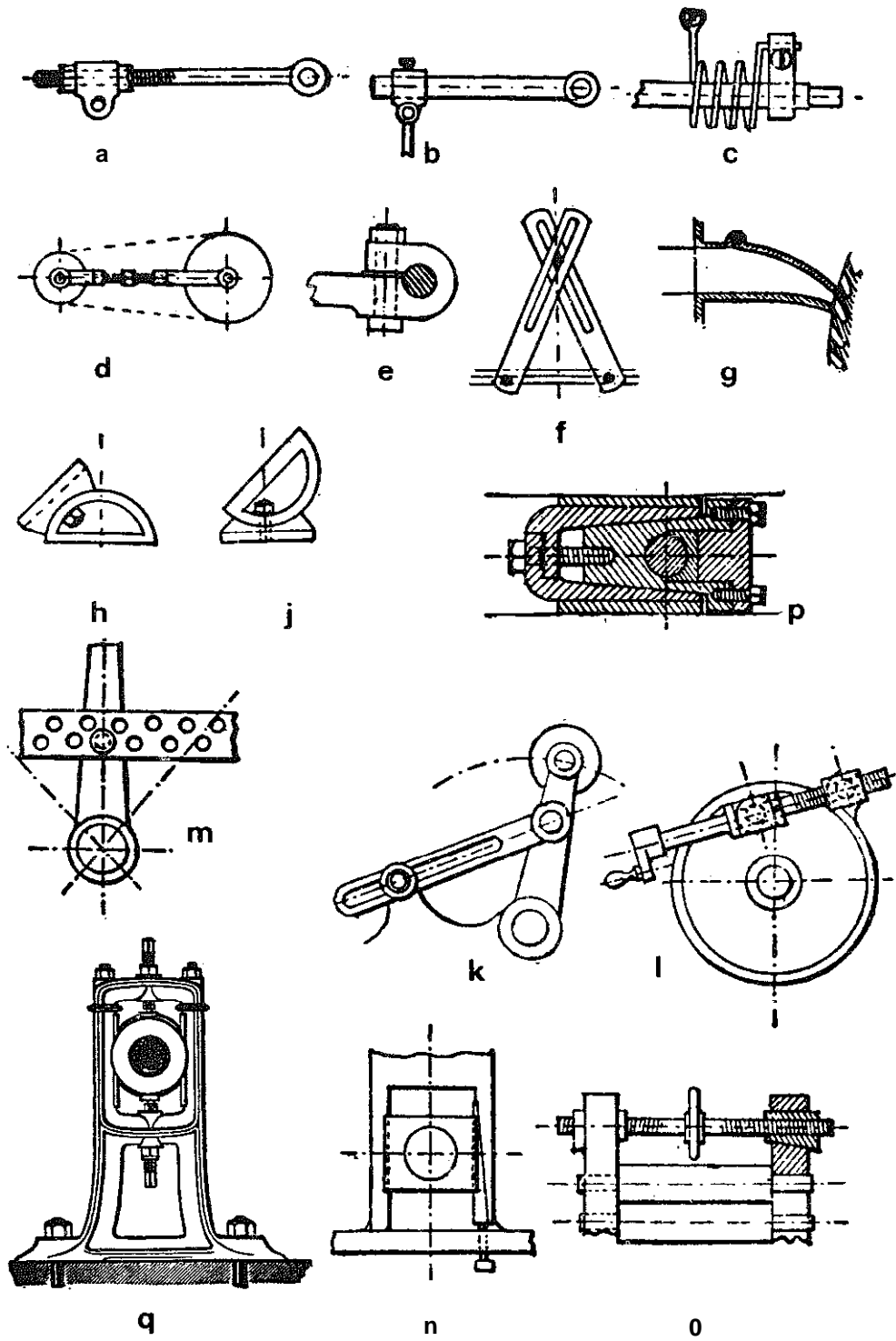

## D-Mechanisms and Kinematics

### 11-ADJUSTING DEVICES (cont)

**r--Horizontal center** adjustment for a vertical shaft step.

**s--Shaft-step** adjustment for spindles of millstones or grinding mills to regulate the space between grinding surfaces.

**t--Adjustable post hanger.**

**u--Adjustable rack.**

**v--Ratchet rod.**

**w--Spring pawl.**

**x--Micrometer adjustment** for a cam-lever grip.

**y--Calipers.**

**z--Screw adjustment** for maintaining rollers parallel.

**aa--Screw adjustment** for a lever.

**ab--Variable-curve** adjustment used in drawing instruments.

ADJUSTING DEVICES

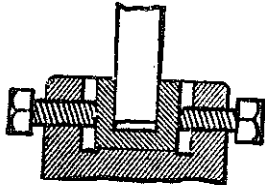

r

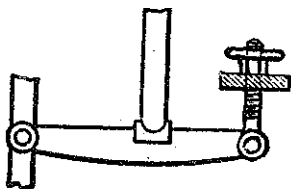

s

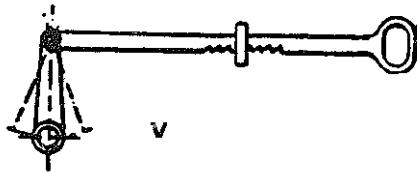

v

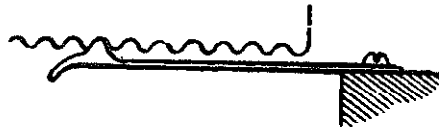

w

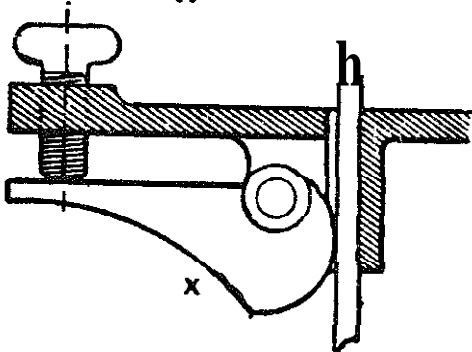

x

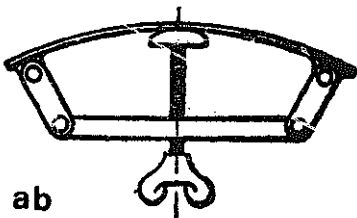

ab

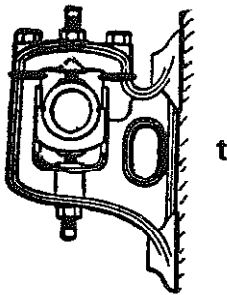

t

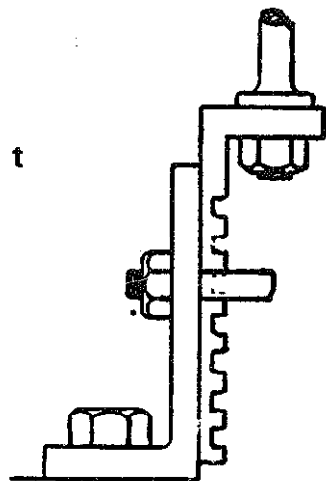

u

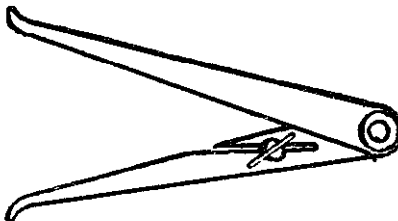

y

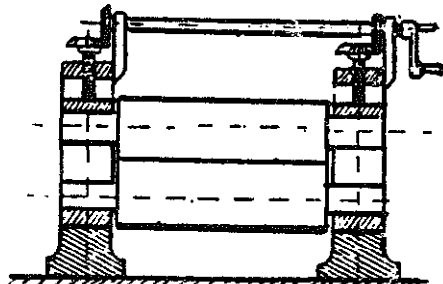

z

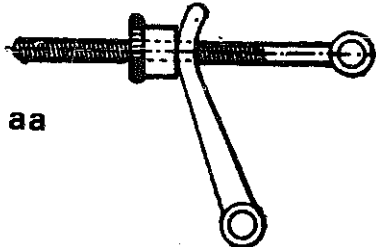

aa

**D—Mechanisms and Kinematics**

11 -ADJUSTING DEVICES (cont)

ac-Adjustable **vertical sheave**.

ad-Adjustment for **tailstock** on a lathe.

ae—**Combined ratchet and hand-feed** gear; the hand screw turns in the worm-gear nut and may be used for quick adjustment.

af—Adjustable **step bearing** with bronze bushing and step; a mortise through the iron base and a key drawn with screw extension and nut are for vertical adjustment.

ag—**Conical-pivot bearing** with adjusting screw.

ah—Adjustable **hanger**.

aj—**Collar bearing** and **step for vertical shafts**; the thrust sleeve of bronze is split and should have a key to prevent rotation.

ak—**Spiral torsion-spring** adjustment.

al—**Micrometer** adjustment.

an-Adjusting **pawl and head** with torsion spring.



ADJUSTING DEVICES

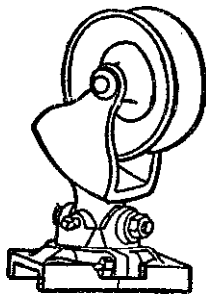

ac

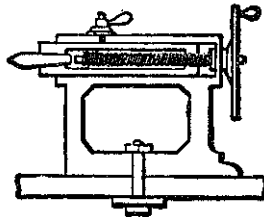

ad

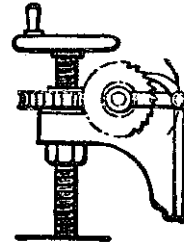

ae

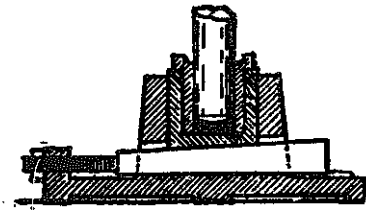

af

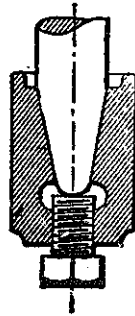

ag

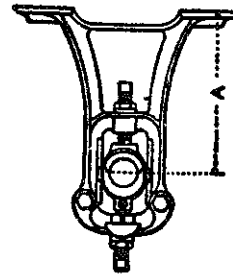

ah

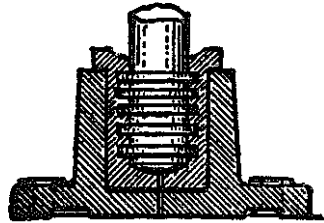

aj

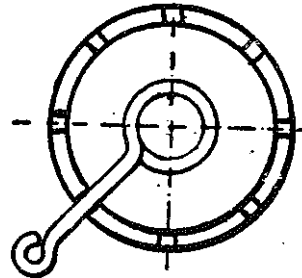

ak

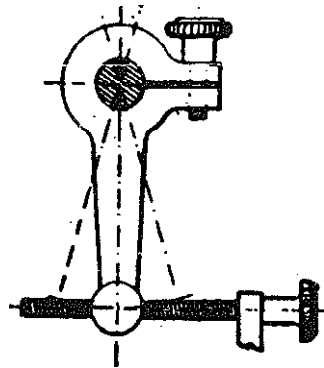

al

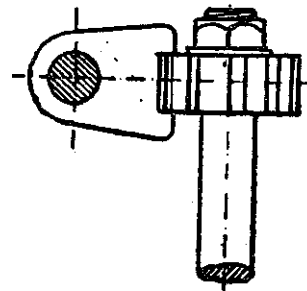

am

## D-Mechanisms and Kinematics

### 11 –ADJUSTING DEVICES (cont)

**an**–**Horizontal center** adjustment.

**ap**–**Leveling** adjustment.

**aq**–Adjustable **center pin** traversed by a screw and fixed after adjustment by a nut and washer.

**ar**–**Fine screw** adjustment for a radial arm.

**as**–**Split cone-sleeves** and setscrew adjustment for a revolving bearing, used where there is much wear.

**at**–**Center-line** adjustment for lathe headstock, etc.

**au**–**Fine screw** adjustment for any movable part.

**av**–Adjustment for **expanding a split borer**, reamer or rosebit.

**aw**–**Division plate** with differential dividing on its opposite faces.

**ax**–**Differential screw**.

# ADJUSTING DEVICES

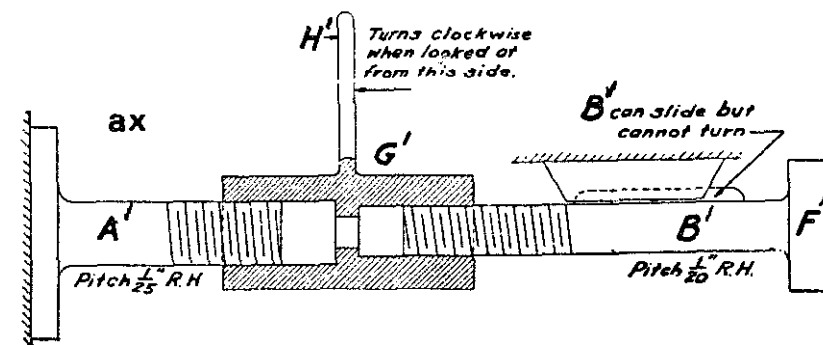
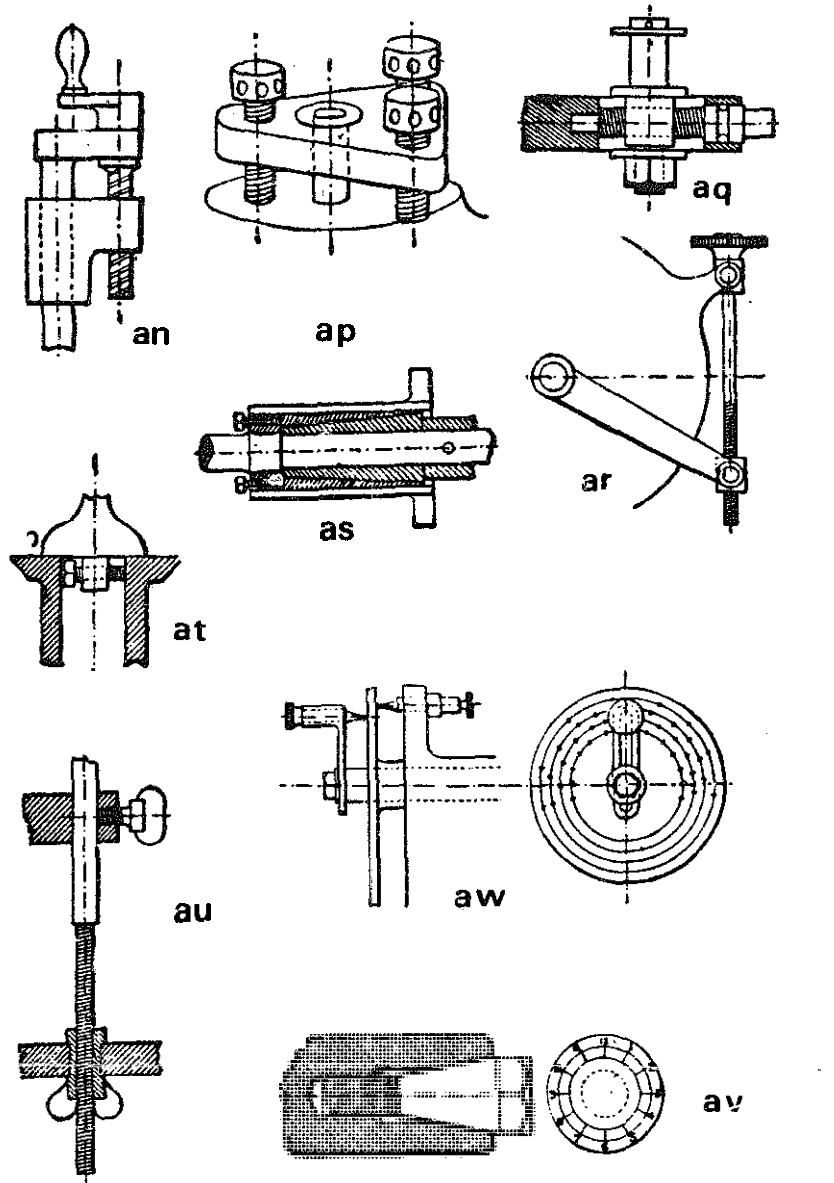

## D-Mechanisms and Kinematics

### 12-SPACE MECHANISMS-(3-D MECHANISMS)

a-Plane form of **four link** mechanism.

**b-Conic or Spherical form** of four link mechanism.

1-rotating input crank

2-Connecting rod

3-oscillating rocker.

**c-Modified conic linkage** arrangement with extended pin connections.

**d-Conic slider-crank** design. Compare corresponding letters and numbers of plane slider-crank "e".

**e-Plane form of slider-crank.** Letters and numbers correspond to those of conic slider-crank of "d".

f-Plane **parallelogram**.

**g-Spherical parallelogram** and its design.

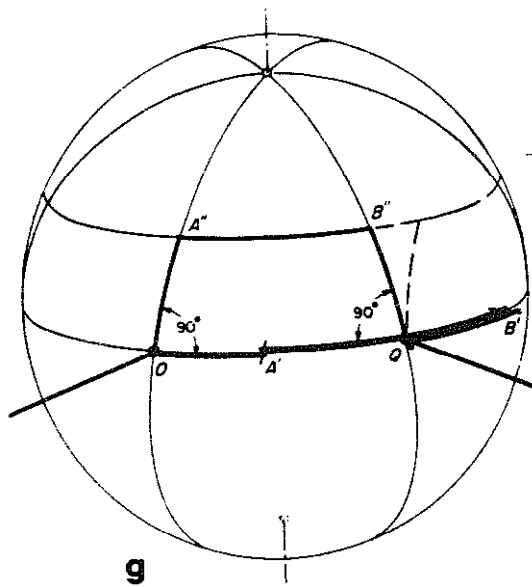
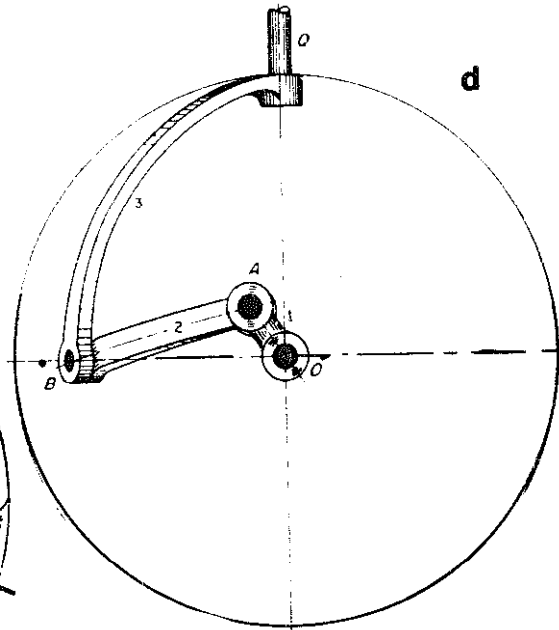
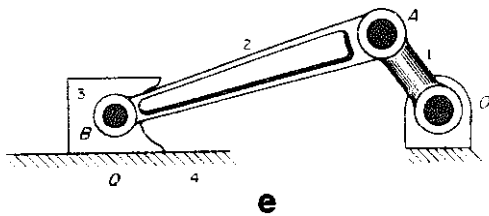
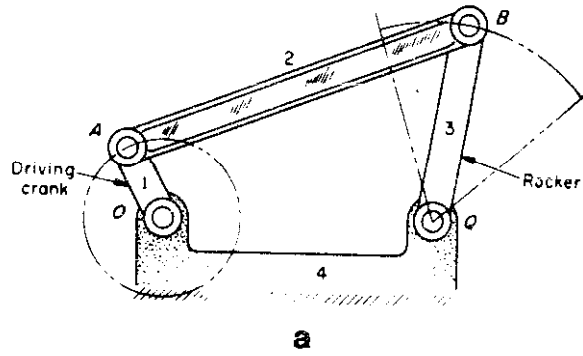
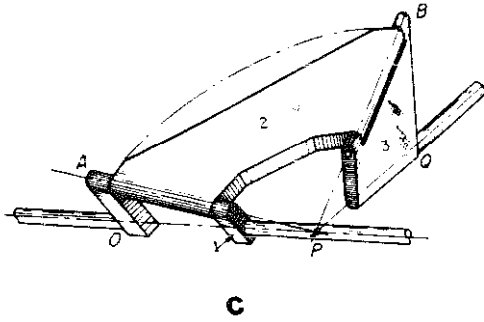
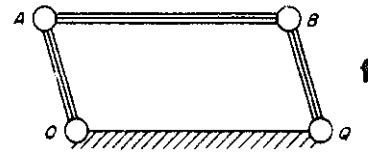
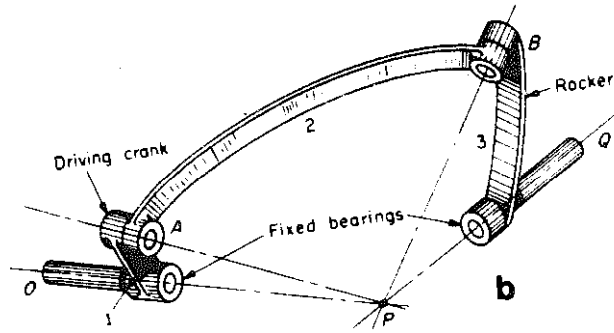

**E—Fastening and Fasteners**

**1 —MARINE AND MASONRY ANCHORS**

**a—Mushroom anchor.**

**b—Trawl or sand anchor;** fast stock, double fluke. Also called “Kedge” or yachtman’s anchor.

**c—Trawl or sand anchor;** loose folding stock.

**d—Grapnel.**

**e—Navy-type swivelling fluke.**

**f—Danforth anchor;** good holding power, light weight.

**g—Northill utility anchor.**

**h—Fisherman’s anchor.**

**j—Laughlin C.Q.R. plow anchor.**

**k—Anchor trip hook.**

**l—Rock anchor** for guy or suspension bridge.

**m—Concrete,** sunk in ground with plate and rod reenforcing.

**n—Mooring screws,** sunk in ground for buoys.

**o—Anchor plate,** sunk in ground for attaching tie rods and guys.

**p—Wall eye,** cast to form brick.

**q—Wall eye,** built in.

**r—Foundation-bolt head,** jagged.

**s—Foundation bolt** with key.

**t—Foundation bolt.**

**u—Rope-pulley leader anchor,** knife-wheel grip in ground.

**v,w,x—Fencing posts in ground.**

**y—Miscellaneous foundation-bolt anchors.**

**z—Expansion bolts.**

MARINE & MASONRY ANCHORS

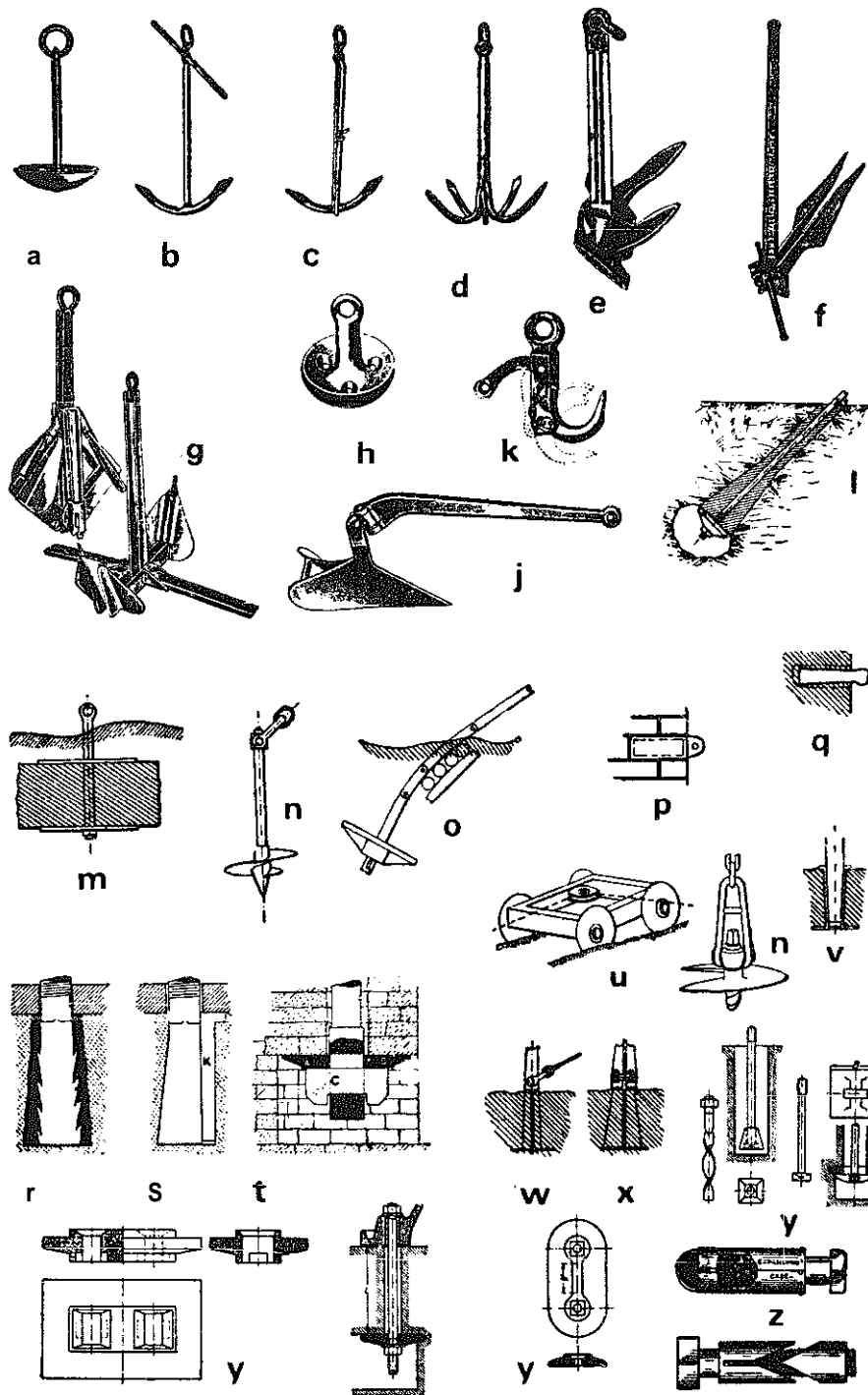

E—Fastening and Fasteners

2-EXPANSION ANCHORS

a—**Spring-wing toggle bolt** for use open and closed.

b—**Spring-wing toggle bolt**: *A* with round head; *B* with square nut; *C* with flat-head screw.

c,d—**Spring-wing toggle bolt** inserted into a drilled hole in tile or gypsum walls.

e—One-piece toggle, without springs.

f—**Lead expansion anchors** for use in concrete, stone, marble, tile, slate, etc.

g—**Expansion plug**, fin position.

h—**Single machine-bolt shield** with two-side expansion for use in concrete, etc., installed without a setting tool.

j—**Double machine-bolt shield**; installed without a setting tool.

k—**Rawl plug**. **Fiber or rawhide wood and lag screw** anchor for use in brick, plaster, concrete, etc.; the hole need not be plumb; no setting tool required; the fiber anchor should be as long as the threaded part of the wood or lag screw and have the same diameter as the screw.

l,m—**Steel expansion shells**; may be used with two cups; no setting tool required; the hole need not be plumb.

n—**Four-point star drill** for making expansion-anchor holes in masonry.

o—**Pipe hook**, snug-fit type.

p—**Adjustable combination pipe hanger**; consists of a six-inch length of perforated hanger iron with a gimlet-pointed lag screw at one end and a pipe ring at the other end.

q—**BX staple**.

r—**Flattened-end lag screw** with bolt for use with a malleable expansion shield.

s,t,u—**Rawl drive expansion plugs**.

v,w—**Two-hole** and **one-hole straps** for supporting wall pipe conduit and armored cable.

x—**Gimlet-point lag screw**; lag screws are measured from under the head to the extreme point.

y—**Expansion shield**.



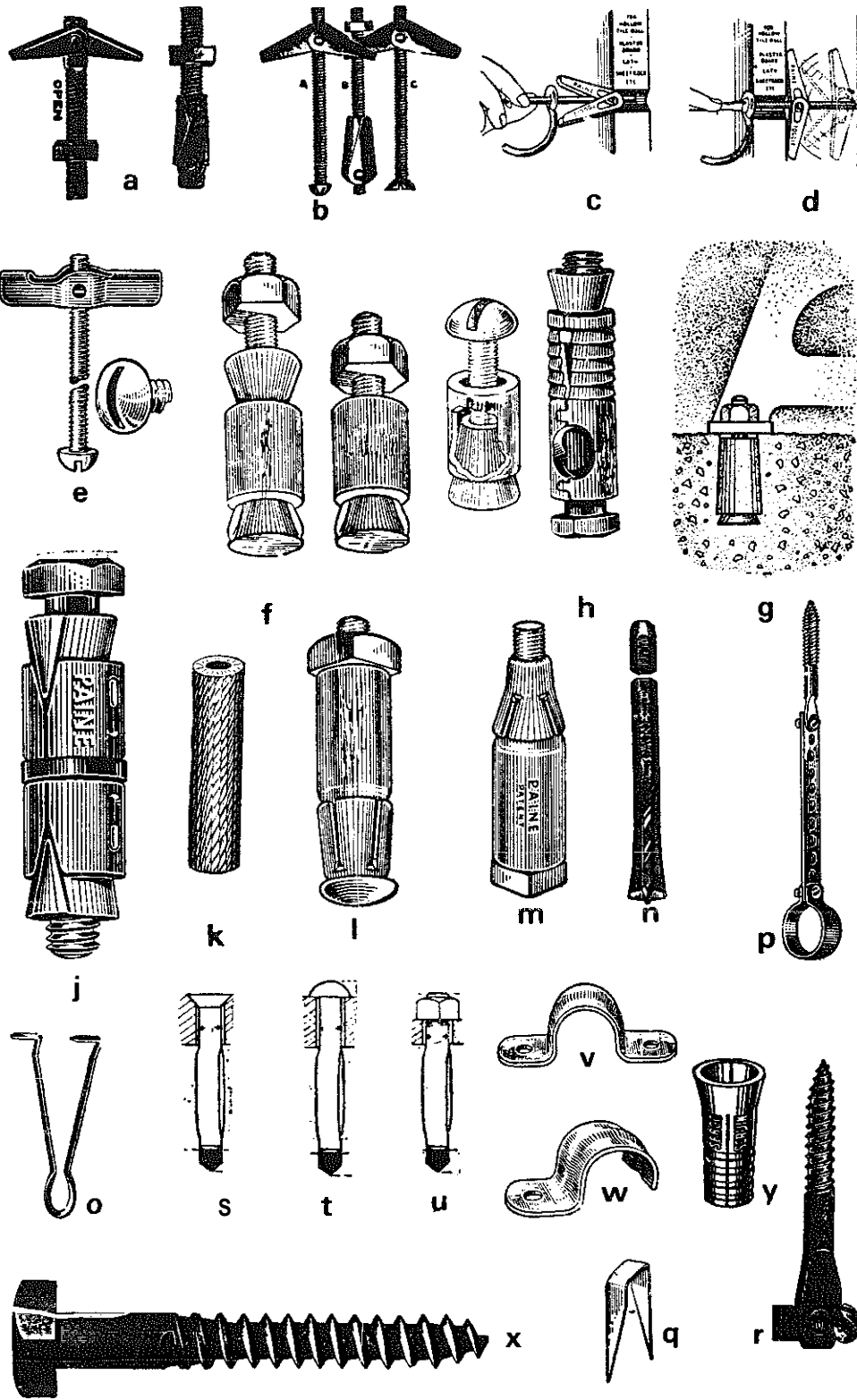

### E—Fastening and Fasteners

3-NAILS-Wire nails are of circular cross-section, cut nails of rectangular cross section, with taper from head to point. Spikes are the larger size nails. Length is often given in the penny system with “d” the accepted abbreviation for it. (2d = 1 in. long, 3d = 1 ¼, 4d = 1½ in. long, up to 10 d. Each ¼ in. adds 1d, but 12 d = 3½ in., 16 d = 4 in., 20 d = 4½ in., 40 d is 5 in. long.)

**a—Railroad spike.** Available in wide range of sizes.

**b,c,d,e—Tie-plate screws.** (Screw spikes). Wide range of sizes available.

**f,g—Diamond and button head boat spikes.**

**h—Cut nail.** Often called carpenters nails. Available in wide variety of sizes, and types, for flooring, casing, common etc.

**j—Common nail, wire,** usually available in sizes from 1 to 6 inches.

**k—Tack, or carpet tack.**

**l—Sash pin.**

**m—Casing nail.**

**n—Finishing nails,** (common brad).

**o—Flooring brad;** available in wide range of sizes.

**p—Common brad.**

**q—Boat nail;** available in many sizes.

**r—Slating nail.**

**s—Shingle nail.**

**t—Hook-metal lathe nail.**

**u—Large-head roofing nail.**

**v—Regular head, roofing.**

**w—Clinch nail.**

**x—Cigar-box nail.**

**y—Hook head.**

**z—Lath.**

**aa—Diamond point.**

**ab—Extra blunt point.**

**ac—Round point.**

**ad—Blunt point.**

**ae—Long point.**

**af—Needle point.**

**ag—Side point.**

**ah—Clout point.**

**aj—Chisel point.**

**ak—Special nails.**

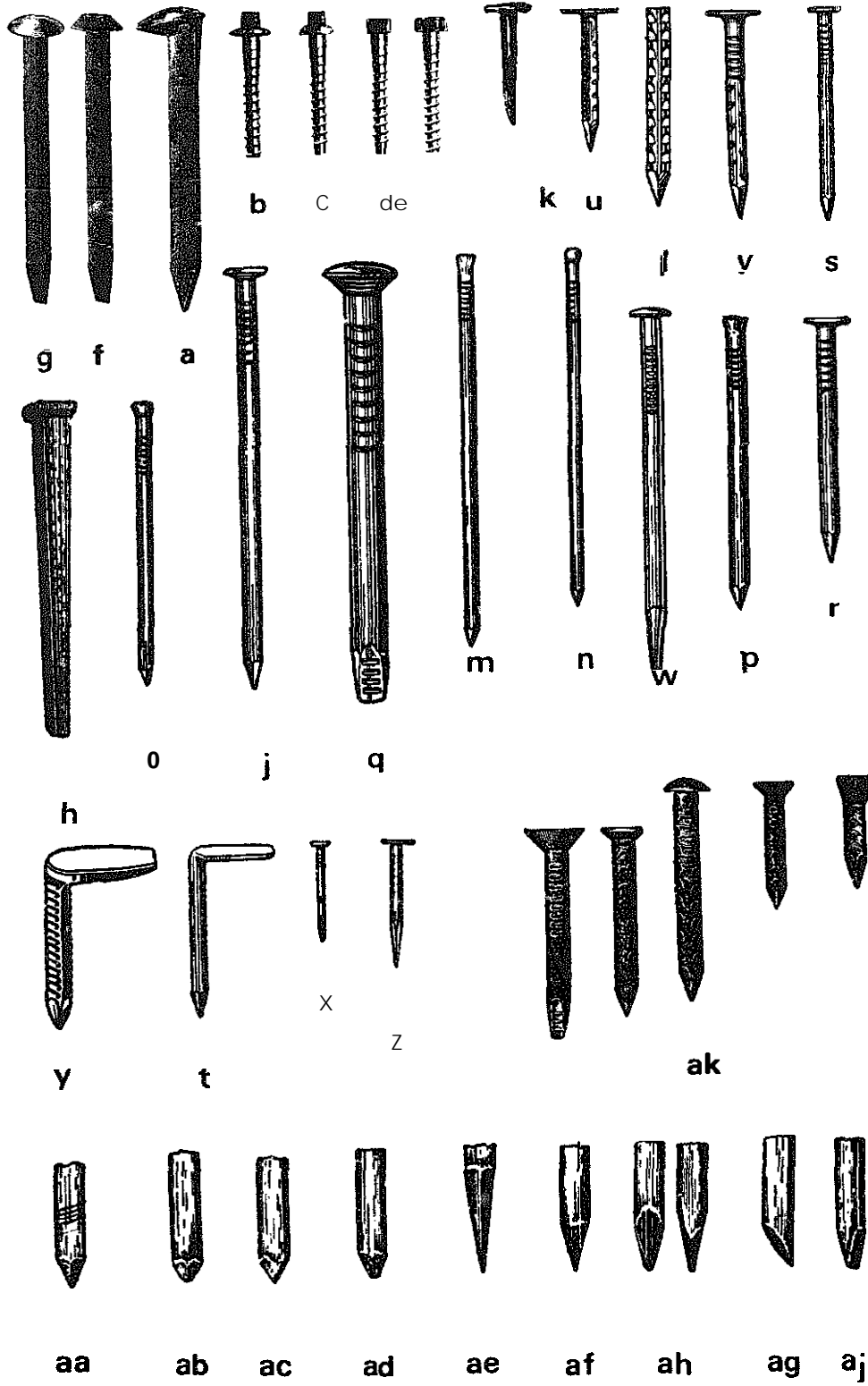

## E--Fastening and Fasteners

### 4-NUTS AND SCREWS

#### Threads

**a**—**American National Standard Thread**, being replaced by the **unified standard screw thread**. Has a coarse thread series (UNC or NC) a fine thread series (UNF or NF) and an extra fine series (NEF).

**b**—Brown and Sharpe 29° worm thread.

**c**—Whitworth's thread.

**d**—Sellers thread.

**e**—Sharp V thread.

**f**—Square thread.

**g**—Buttress thread.

**b**—Acme standard thread.

**j**—Round or knuckle thread.

#### Nuts

**k**—Machine screw nut

**l**—Regular square nut.

**m**—Hex slotted nut.

**n**—Hex thick nut.

**p**—Hex jam nut.

**q**—Hex castle nut.

**r**—Hex thick slotted nut.

**s**—High slotted nut.

**t**—12 point nut.

**u**—Cap (Acorn) nut.

**v**—Hex flange nut.

#### Screw Heads

**w**—Truss head.

**x**—Binding head.

**y**—Button.

**z**—Fillister.

**aa**—82° Flat head.

**ab**—Flathead, undercut.

**ac**—Hex head.

**ad**—Headless, used for set screws only.

**ae**—Pan head.

**af**—Oval undercut.

**ag**—Round head.

**ah**—Flat fillister head.

**aj**—Hex socket head.

**ak**—Phillips recess.

**al**—Fluted socket.

**am**—One way.

**an**—Drilled spanner.

**ap**—Pozidriv recess.

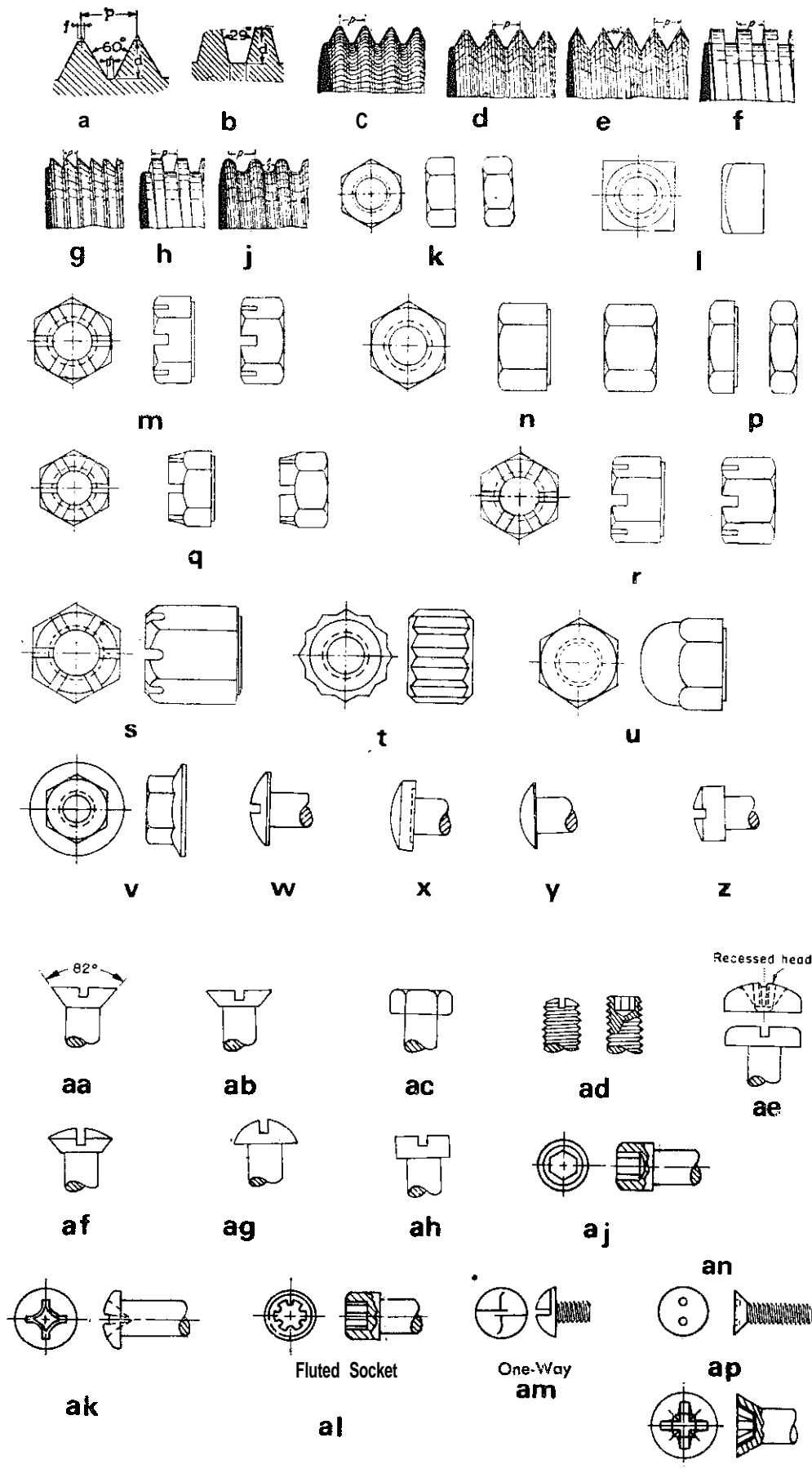

E—Fastening and Fasteners

4—NUTS AND SCREWS (cont)

Special Bolt Heads

- aq—Eye bolt.
- ar—Hook bolt.
- as—Countersunk head.
- at—Special head.
- au— $\bar{r}$ -head.
- av—Wedge head.
- aw—Eye bolt.
- ax—Boss-head bolt.
- ay—Lifting-eye bolt.
- az—Conical-head bolt.
- ba—Fluted nut.
- bb—Screw-driver nut.
- bc—Capstan nut.
- bd—Spring pawl.
- be—Nut with stop pin.
- bf—Split nut.
- bg—Nut with cotter pin.
- bh—Nut with taper pin, split.
- bj—Locking plate.
- bk—Lock washer.
- bl—Ring nuts.
- bm—Nut with setscrew.
- bn—Pin nut.
- bo—Wing nut.
- bp—Nut with holes for a forked spanner.
- bq—Stud driver.
- br—Jam nuts.

NUTS & SCREWS

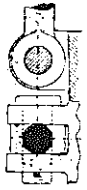

aq



ar



as



at



au

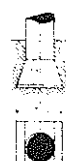

av

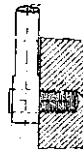

aw

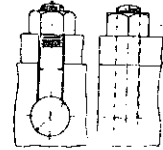

ax

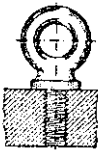

ay

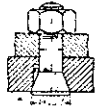

az

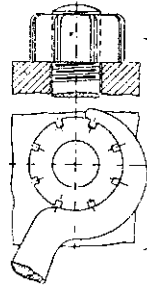

ba

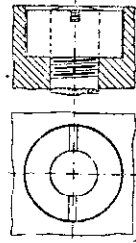

bb

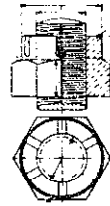

bc

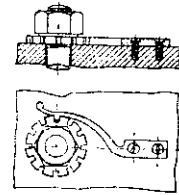

bd

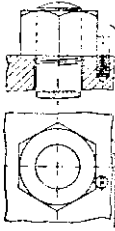

be

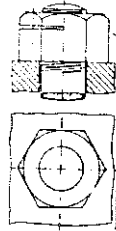

bf

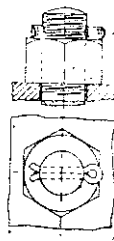

bg

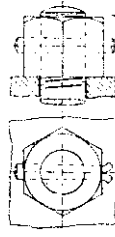

bh

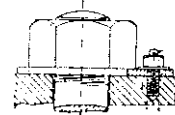

bj

bk

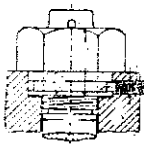
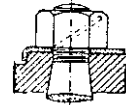

bl

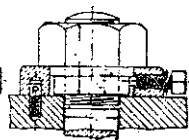

bm

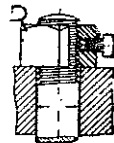

bn

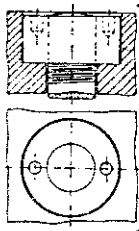

bp



bq



bo

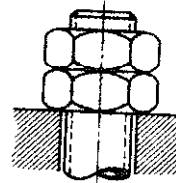

br

## E-Fastening and Fasteners

### 4-NUTS AND SCREWS (cont)

#### Lock Washers

**bs**—Spring lock washer.

**bt**—External tooth lock washer.

**bu**—Internal tooth lock washer.

#### Special Nuts

**bv**—“Flexloc” combination-lock and stop nut with National coarse or fine thread.

**bw**—Elastic self-locking stop nut; the standard thickness shown; shaded cross-section shows elastic locking collar which is smaller than the bolt diameter. (Esna)

**bx**—Speed nut (Tinnerman Products, Inc.) for use on any type of screw or bolt.

**by**—Tinnerman Speed nut before tightening.

**bz**—“by” after tightening.

**ca**—Same as “by” but additionally snaps over panel edge and is self-retaining for blind assembly.

**cb**—Same as “by” but angle type.

**cc**—Clinch nut. (Elastic Stop Nut Corp. of America)

**cd**—Cage Nut.

**ce**—Clinch nut

**cf**—Clevis.

**cg**—Cotter pin.



NUTS & SCREWS

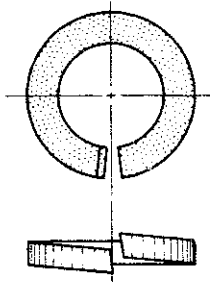

bs

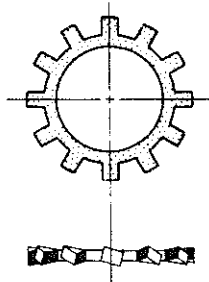

bt

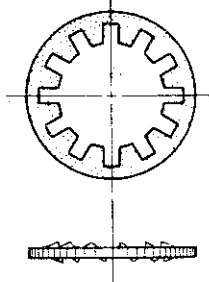

bu

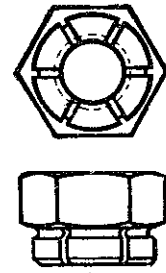

bv

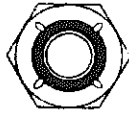

bw

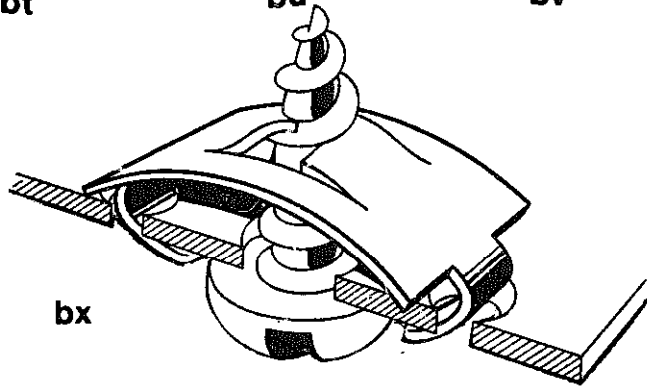

bx

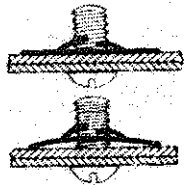

by, bz

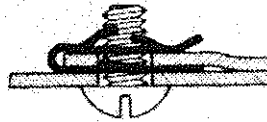

ca

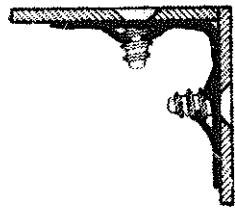

cb

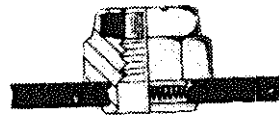

cc

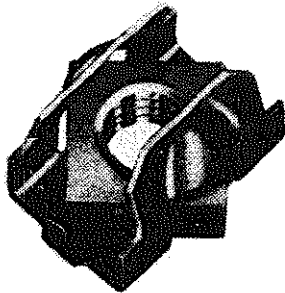
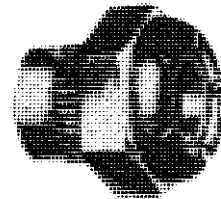

Cd

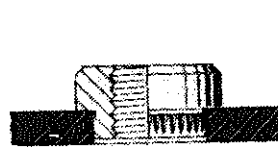
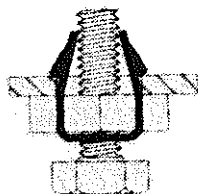

ce



cf



cg

## E-Fastening and Fasteners

### 4-NUTS AND SCREWS (cont)

#### Bolts

**ch**—**Bolt** with a head requiring special spanner or pointed bar.

**cj**—**Cylinder-head bolt** with drilled holes and special spanner.

**ck**—**Cylinder-head bolt** with **flutes** for the spanner.

**cl**—**Cylinder-head bolt** with two flat surfaces to fit the standard spanner wrench.

**cm**—**Socket-head bolt** for receiving a screw.

**cn**—**Milled-head** screw.

**cp**—Bolt with a **head for a forked spanner**.

**cq**—**T-head** bolt.

**cr**—**Hexagon-collar** bolt.

**cs**—**Hexagon-head bolt** with collar.

**ct**—**Eye** bolt with flat sides.

**cu**—**Hook** bolt,

**cv**—**Lewis** bolt for concrete.

**cw**—**Hook** bolt.

**cx**—**Solid-head** and collar bolt (bed bolt).

**cy,cz**—**Heads** for bolts to slide and turn in **T-grooves** of planing machines.

**da**- Turnbuckle.

**db**—**Belt** screw.

**dc**—**Ball-head** bolt and nut; it may be drawn out of line.

**dd**—**Mutilated screw** and **nut**.

**de**—**Coned bolt** for securing and keying two parts of a machine in exact relation.

**df,dg,dh**—**Molly** bolt and application.

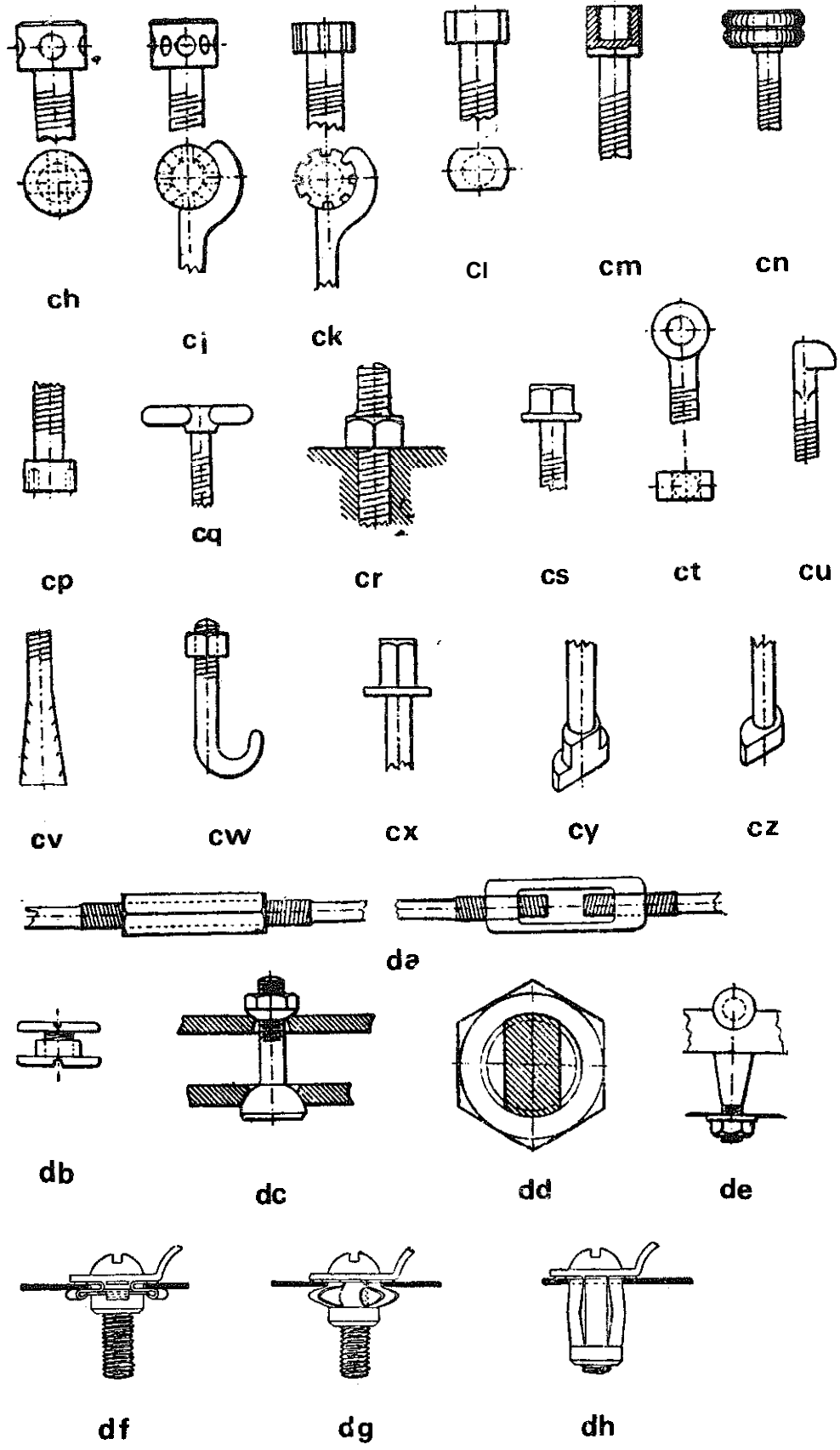

E—Fastening and Fasteners

4—NUTS AND SCREWS (cont)

Miscellaneous Bolts

**dj**—Countersunk head square neck carriage bolt.

**dk**—Step bolt.

**dl**—Countersunk bolt.

**dm**—Round head bolt.

**dn**—Hex cap bolt.

**dp**—Square head bolt.

**dq**—Round head short square neck carriage bolt.

**dr**—Square countersunk head plow bolt.

**ds**—Round countersunk heavy key head plow bolt.

**dt**—Joint bolt

**du**—Round head ribbed neck carriage bolt.

**dv**—Closed eye bolt.

**dw**—Open eye bolt.

**dx**—U-Bolt, round bend.

**dy**—Hook bolt.

**dz**—Hook bolt.

**ea**—U-Bolt, square bend.

**eb**—Liner bolt.

**ec**—Silo Rod.

**ed**—Double end rod.

**ee**—Upset rod.

**ef**—Pipe band.

**eg**—Mutilated screw to slide into nut, closes by partial turn. Used in breech pieces of artillery.

**eh**—Bolt with keyed washer to prevent turning.

**ej**—Flat head wood screw.

**ek**—Oval fillister-head wood screw.

**el**—Stud.

**em**—Drive screw.

NUTS & SCREWS

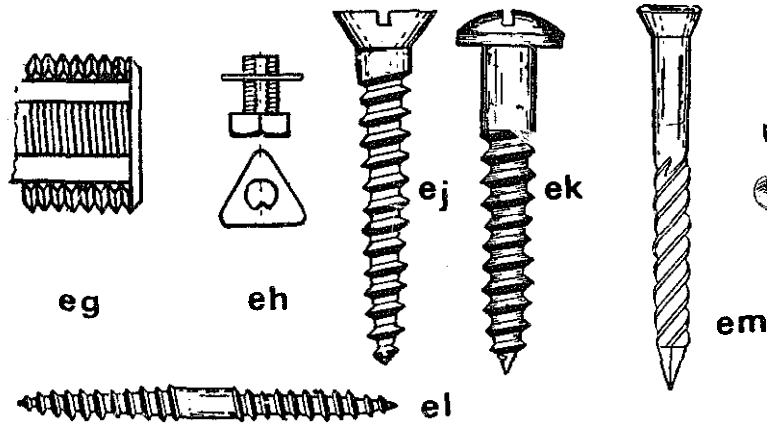
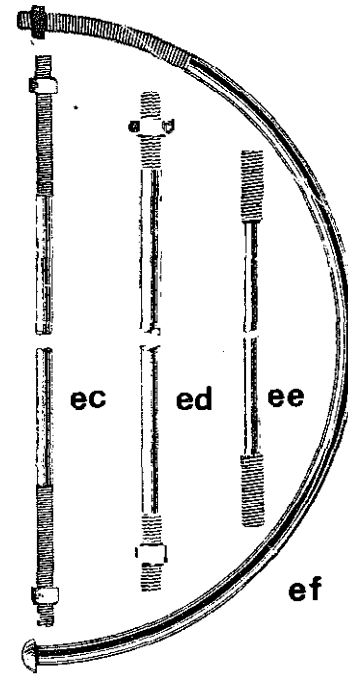
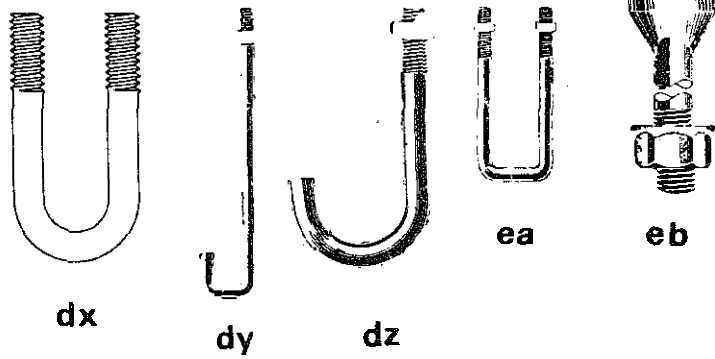
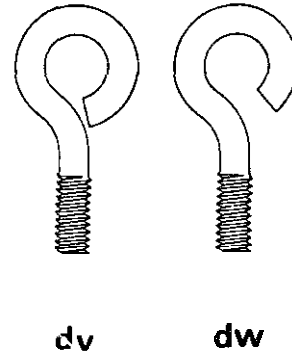
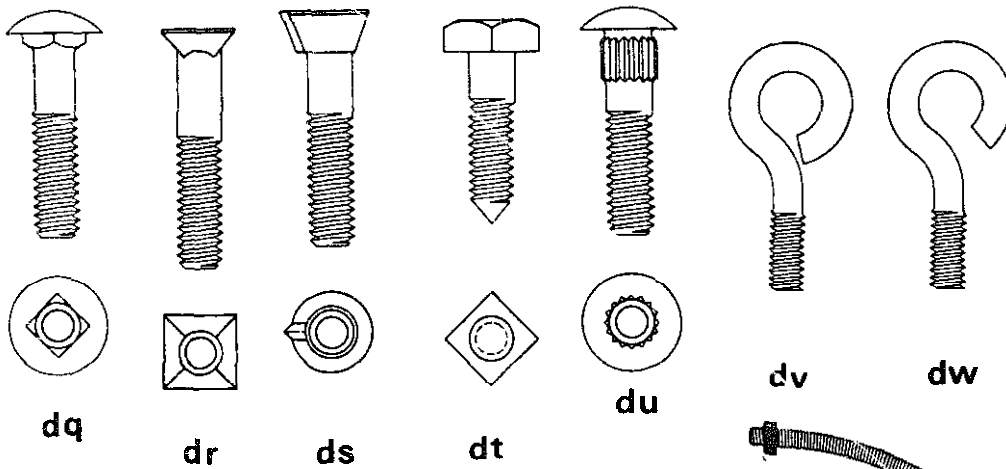
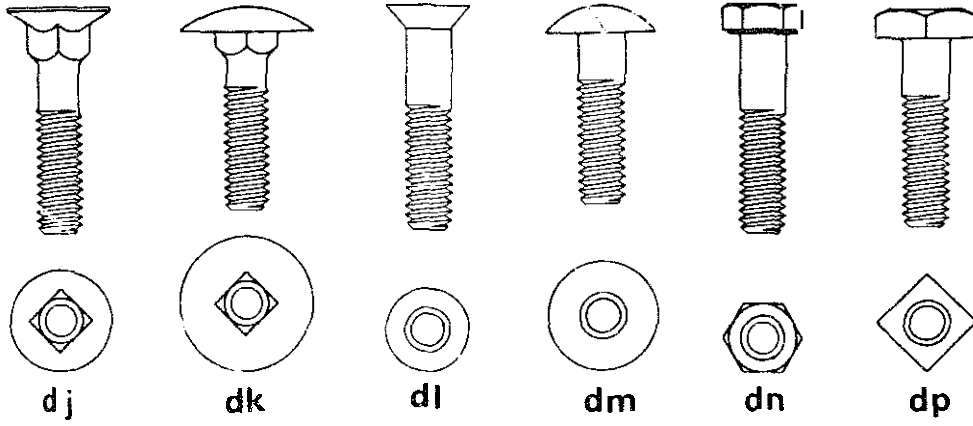

## E—Fastening and Fasteners

### 4—NUTS AND SCREWS (cont)

#### Tapping Screws

- en**—Self drilling tapping screw.
- ep**—Same as “en”.
- eq**—Tapping screw with pre-assembled washer.
- er,es**—Same as “eq”.
- et**—Tapping screw with pre-assembled **sealing washer**.
- eu**—Cutting end of **multiple threaded** drive screw.
- ev,ew,ex**—Cutting ends of various tap screws.

#### Set Screws

- ey**—Hexagon socket head set screw.
- ez**—Fluted socket head set screw.
- fa**—Slotted headless set screw.
- fb**—Square head set screw.
- fc**—Cup-point.
- fd**—Cone point.
- fe**—Oval point.
- ff**—Flat point.
- fg**—Half dog.
- fh**—Full dog.
- fj**—Self locking knurled cup point, type C.
- fk**—Self locking **Nu-Cup** point, type F.
- fl**—Self locking **hexagon cup point**, type D.

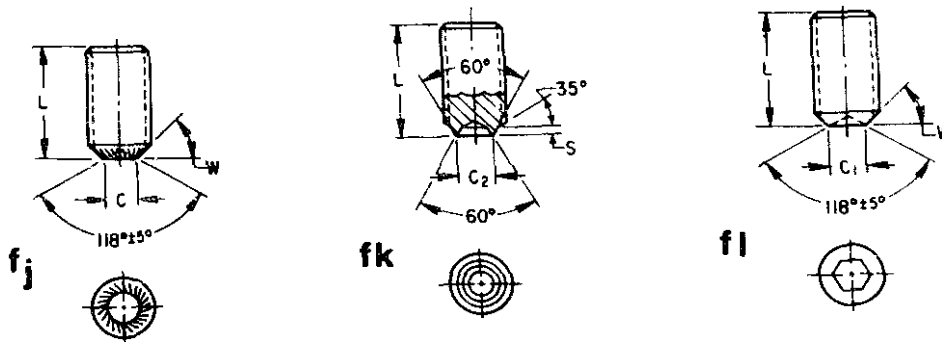
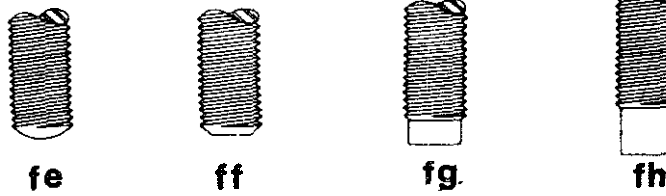
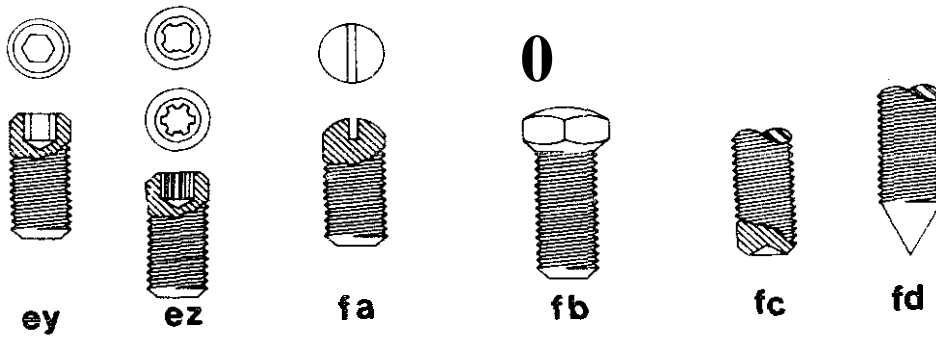
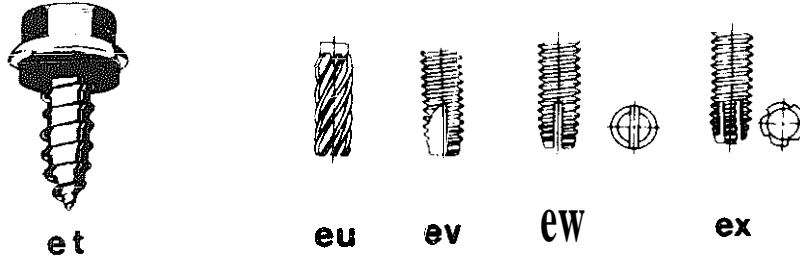
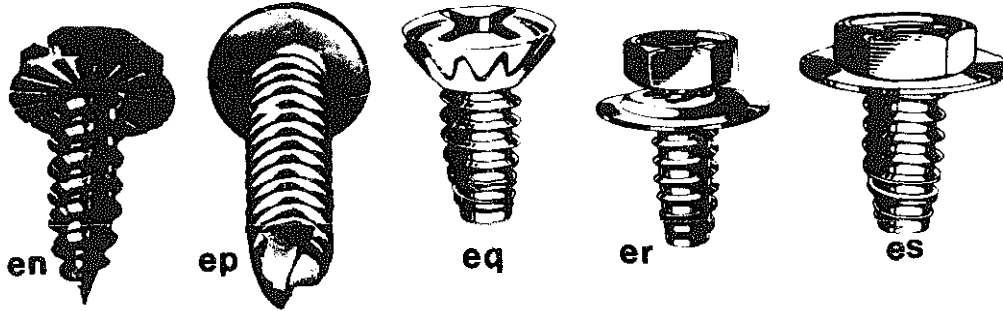

## E—Fastening and Fasteners

### 5—METAL JOINTS

- a—**Dovetail metal** joint; the dovetail is slightly tapered.
- b—**Bayonet** joint.
- c—**Common male and female** or nipple and socket rod joint.
- d—**Double-scarfed** joint.
- e—**Knuckle** joint for levers.
- f—**Pivot**.
- g—**Double riveted butt** joint.
- h—**Forked joint** with stepped gibs.
- j—**Forked joint** and **swivel block** for screw attachment.
- k—**Swivel joint** for pipe work.
- l—**Screw socket and spigot** joint for rods.
- m—**Conical** socket joint and setscrew.
- n—**Scarfed joint** locked by a cross cotter and tapered ferrule.
- o—**Swivel** joint.
- p—**Tapered drill socket**.
- q—**Rod coupling**.
- r—**Sheet-metal** joint, grooved seam.
- s—**Sheet-metal** joint, standing seam.
- t—**Sheet-metal** joint, slip, also S - cleat.
- u—**Sheet-metal** joint, drive slip, or drive cleat.
- v—**Sheet-metal** joint, end slip.
- w—**Sheet-metal** joint, double seam.
- x—**Sheet-metal** joint, Pittsburgh seam.
- y—**Sheet-metal** joint, bar slip.
- z—**Sheet-metal** joint, reinforced bar slip.
- aa—**Sheet-metal** joint, pocket slip.
- ab—**Sheet-metal** joint, angle connection.



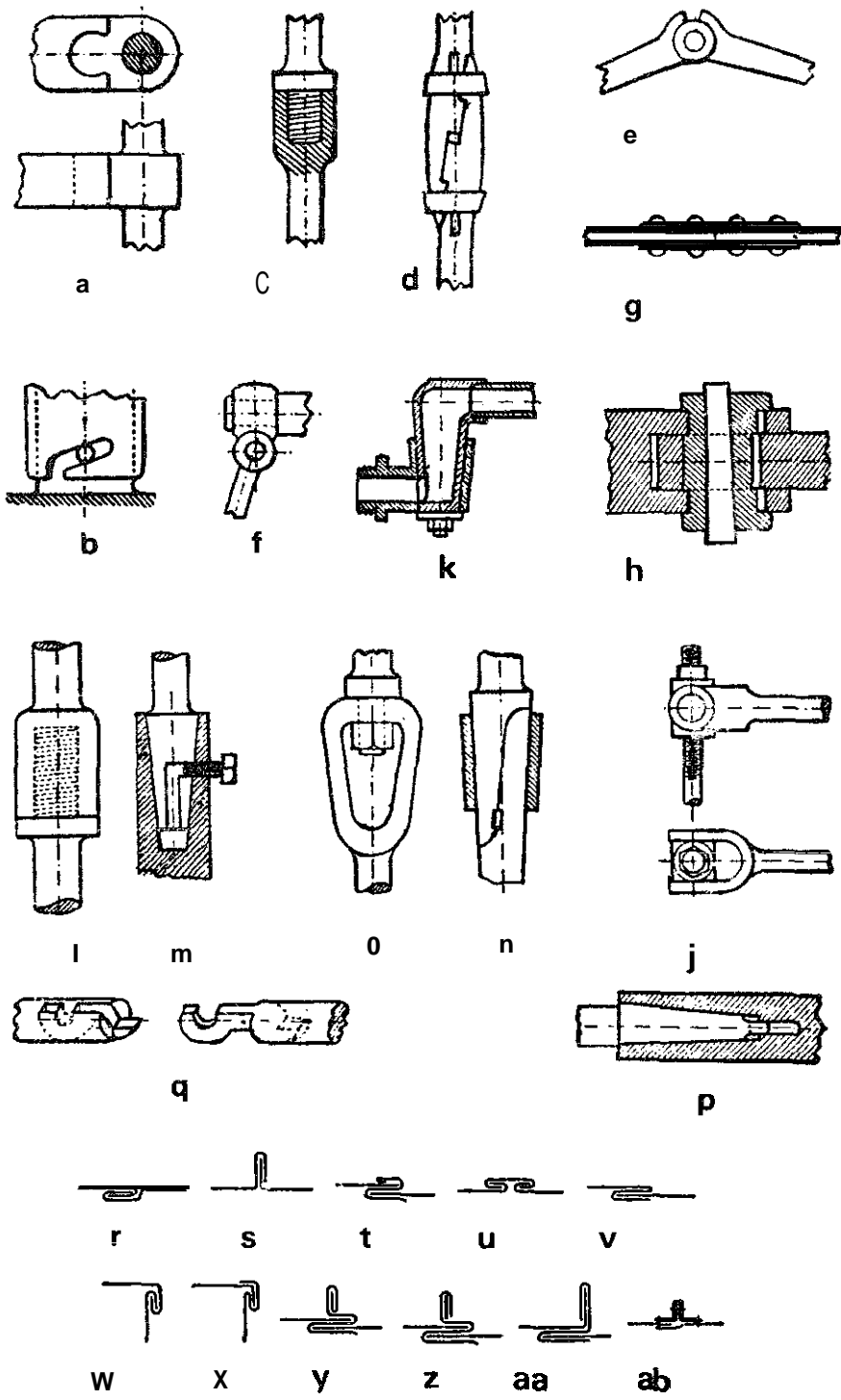

## E—Fastening and Fasteners

### 5—METAL JOINTS (cont)

ac—Location of elements of a **welding symbol**. (from Standard Welding Symbols, A2.0—68, The American Welding Society, Inc., New York 1968.)

ad—Arc and gas **weld symbols** (from Standard Welding Symbols, A2.0—68, The American Welding Society, Inc., New York 1968)

ae—**Additional symbols**. (Same source)

af—**T-fillet weld**.

ag—**Groove butt weld**.

ah—**Plug weld**.

aj—**Shielding of the arc** and slag protection of weld while cooling.

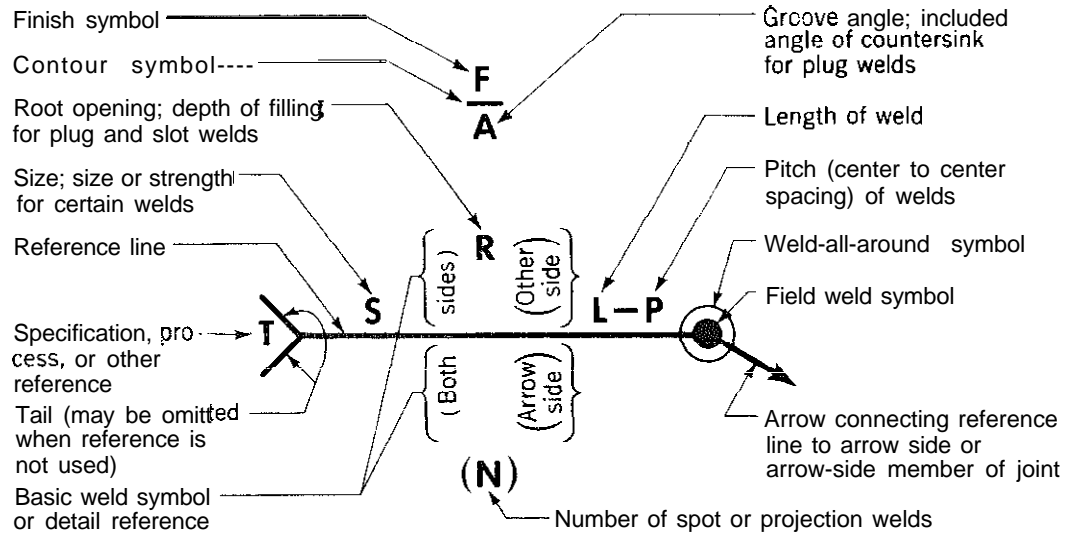

ac

Type of weld										
Fillet	Plug or slot	Groove							Flange	
		Square	V	Bevel	U	J	Flare-V	Flare-bevel	Edge	Corner

ad

Weld all around	Field weld	Melt-thru	contour		
			Flush	Convex	Concave

ae

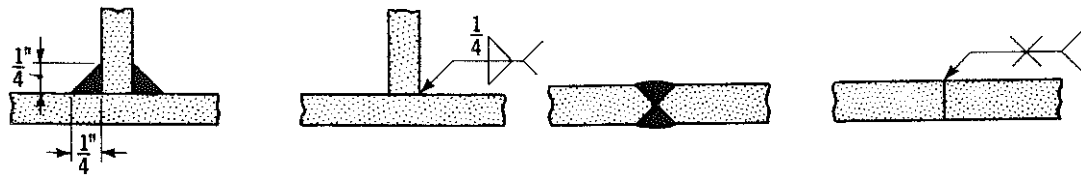

af

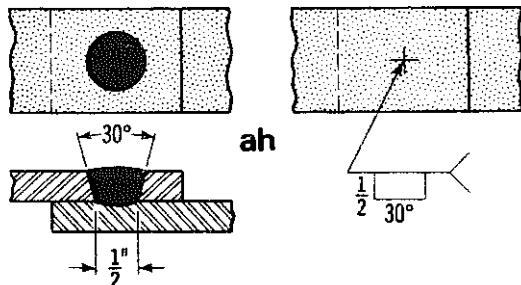

ah

ag

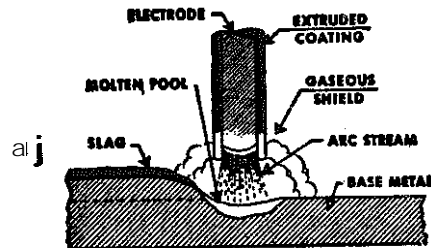

aj

**E—Fastening and Fasteners**

**5—METAL JOINTS (cont)**

Rivets-small solid

- a—Pan head.**
- b—Button head.**
- c—Countersunk head.**
- d—Flat head.**
- e—Belt.**
- f—Cooper's.**
- g—Tinnners'.**
- h—Truss head.**

Rivets-large,  $\frac{1}{2}$ " diameter and larger

- j—Button.**
- k—High Button head.**
- m—Flat top countersunk.**
- n—Pan head.**
- p—Round top countersunk.**

Non-standard heads

- q—Steeple (Boiler rivet).**
- r—Oval.**
- s—Machine.**
- t—Globe.**
- u—Rivet tools.**
- v—Rivets before and after assembly.**
- w—Double riveted lap joint zig-zag pattern.**
- x—Single riveted butt-joint.**
- y—Use of caulking tool.**

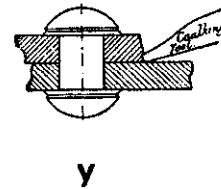
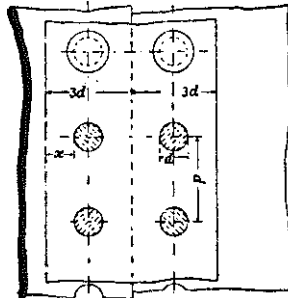
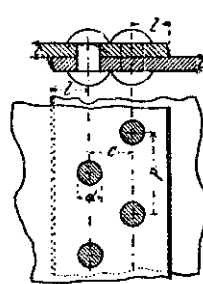
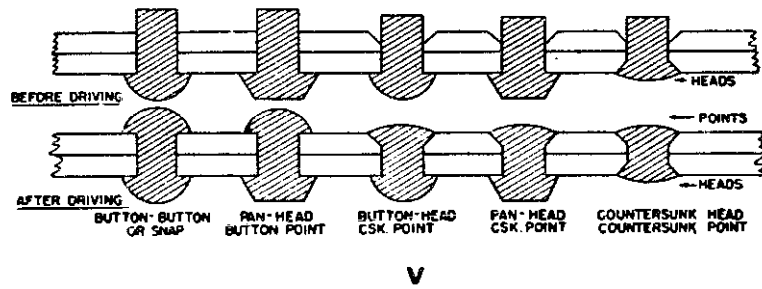
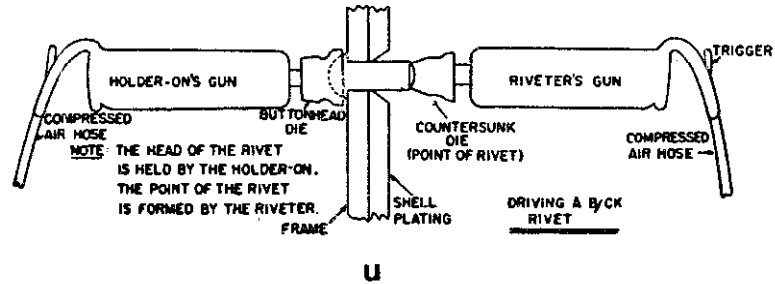
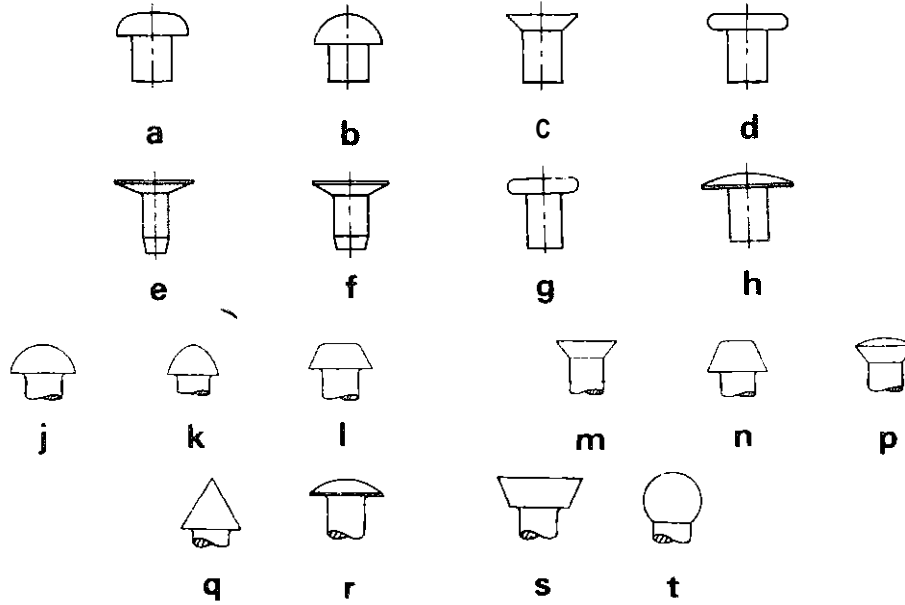

**E—Fastening and Fasteners**

**6—WOODWORKING JOINTS**

- a—Plain butt.
- b—Corner butt.
- c—Rabbet.
- d—Rabbet and miter.
- e—Rabbet and dado, and housed dado.
- f—Halved cross lap joint.
- g—Corner lap joint.
- h—Half-lap butt.
- j—Plain miter butt.
- k—Miter half-lap butt.
- l—Mortise and tenon.
- m—End mortise and tenon.
- n—Peg tenon or doweled butt.
- o—Blind housed tenon.
- p—Notched butt.
- q—Plain dovetail butt.
- r—Half-blind dovetail butt.
- s—Dovetail half-lap joint.
- t—Scarf joints, showing half joint at right-hand end.
- u—Checking.
- v—Chamfering.
- w—Groove.
- x—Tongue and groove.
- y—Rabbeting.
- z—Stave work.
- aa—Segment work.
- ab—Closed mortise and tenon.

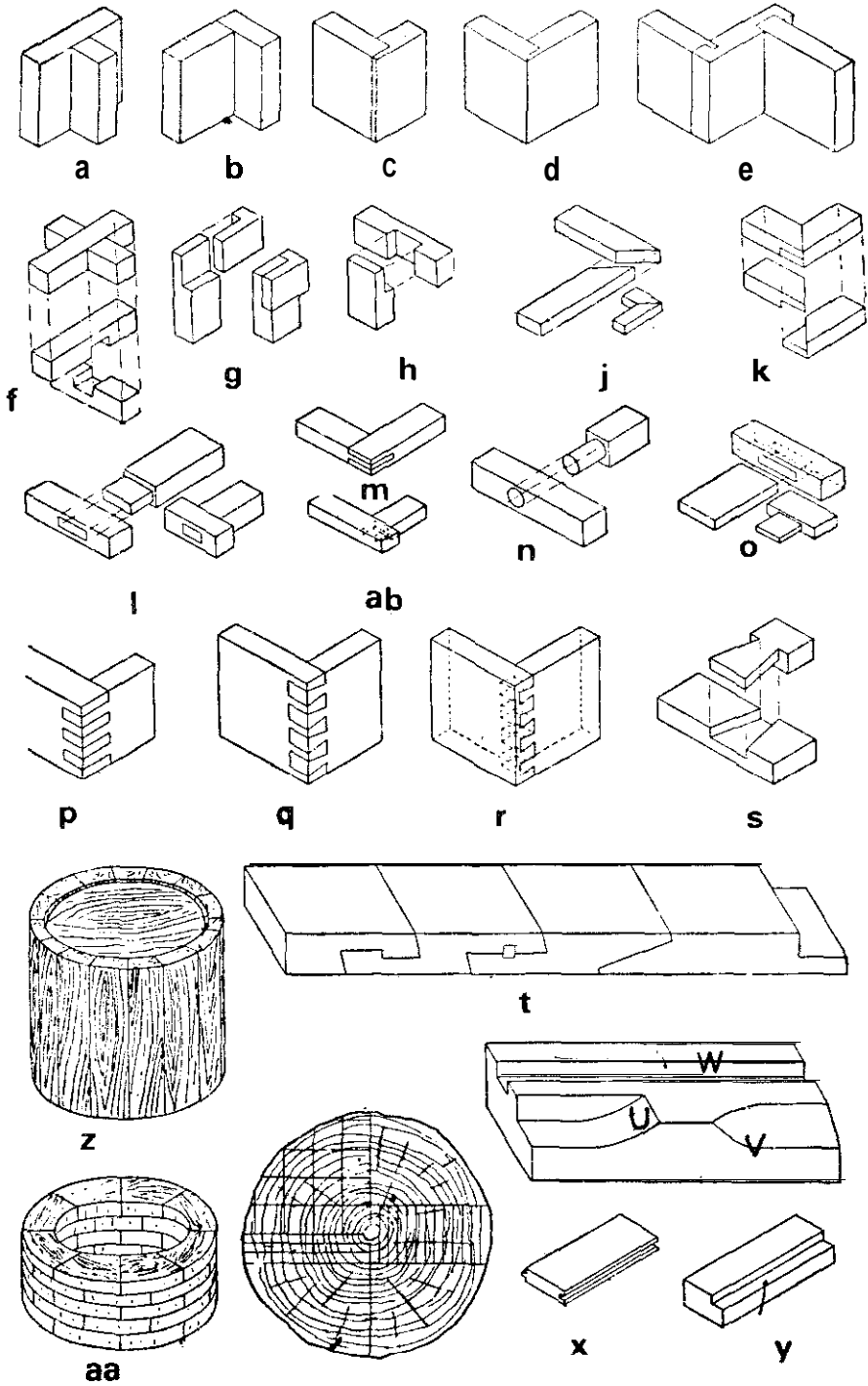

## E-Fastening and Fasteners

### 'I-TIMBER JOINTS

- a--Straight** splice. bolted.
- b--Lap** splice with iron keys and bolts.
- c--Butt** joint with timber fish plate, keyed and bolted; without keys, it is suitable for compression only.
- d--Butt** joint with double timber fish plate, bolted.
- e--Compression beam**, bolted and held by a fish plate and bolts.
- f--Splicing by breaking** joints, and bolting.
- g--Lap** splice with oak keys and yoke straps.
- h--Scarf-and-butt joint**, with one fish plate bolted.
- j--Scarf-and-butt** splice, with iron fish plates bolted.
- k--Lap-and-scarf** butt joint, keyed with oak and locked with anchor fish plate and bolts.
- l--Queen-post roof truss.**
- m--Wooden road bridge truss.**
- n--Natural splitting of tree.**
- o--Shrinkage** of planks after drying.
- p--Shrinkage** when cut into quarters.
- q--Dried timber warped** after planing on one side.
- r--Fang plate.**
- s--Fang-plate washer** for wood.
- t--Staple** bolt and washer plate.
- u--Colonial plank floor**, showing keys and plugs.
- v--Brass dowels** for core boxes.
- w--Butt-and-lap plate** scarf joint.
- x--Bending** scarf joint.
- y--Notched mortise-and-tenon** joint with anchor strap.
- z--Butt** joint anchored with a key, bolt and washer.
- aa--Rabbeted** or housed buff joint for wooden tank construction; face all joints with paint or white lead and secure with wood screws for watertightness.



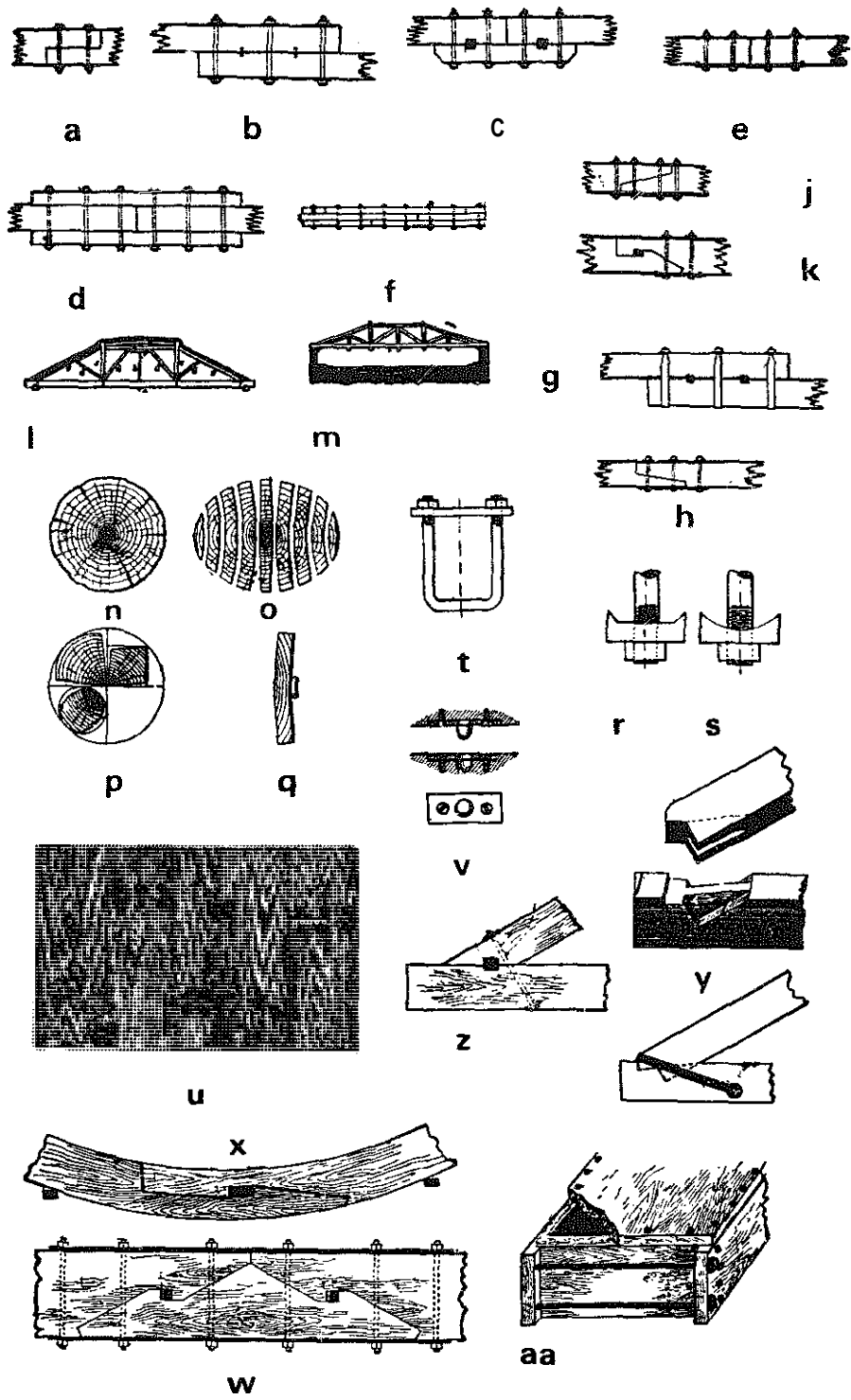

## E-Fastening and Fasteners

### 8-CLAMPING AND LOCKING DEVICES

**a-Bolt lock**; the bolt can be released by turning at 180°.

**b-Combination lock** consisting of any number of discs on a spindle having a feather key, arranged so that the discs must all be in a certain position to allow the key to slide through a notch or **keyway**, cut in each disc, for opening the loop.

**c-Gib key** fastening.

**d-Gib key** using a wooden bar.

**e-Catch and hook**.

**f-Hinged catch** for locking a screwed gland or nut.

**g-Half-nut locking and** unlocking device used for lathe lead screws; the half nuts are moved simultaneously in opposite directions by cams on the lever spindle.

**h-Swinging catch** for securing the end of a drop bar.

**j-Locking** screw for locking the hand wheel and spur pinion to the drive shaft to establish operating position.

**k-Lever mechanism** for opening or closing a gate or door.

**l-Locked shutter bar** with swinging pawl.

**m-Drop catch** for a bar.

**n-Wedge-plate** and screw fastening for cutters.

**p-Hinged bolt** and handle nut for locking and tightening a door.

**q-Handle nut** with tapered flange for fastening down flat work.

**r-Parallel bar** movement for railway switches.

CLAMPING & LOCKING DEVICES

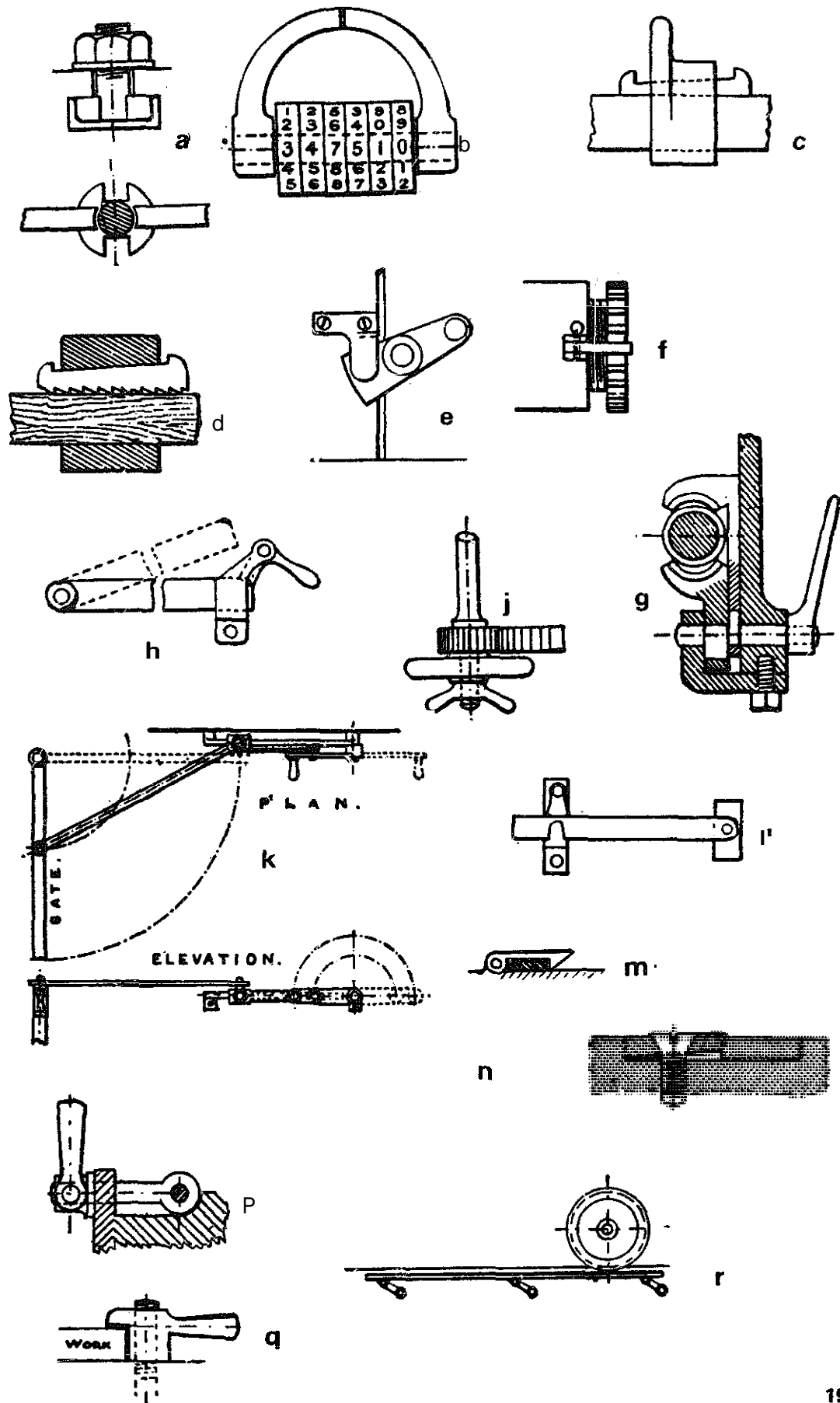

E—Fastening and Fasteners

8—CLAMPING AND LOCKING DEVICES (cont)

s—**Setscrew** fastening for flange and socket.

t—**Locked** center pin.

u—**Hinged handle**, combined latch and staple.

v—**Wire-ring** locking device, the wire being driven into the groove through holes drilled in line with the wire groove.

w—**Cotter** for locking a sliding spindle.

x—**Locking pawl**

y—**Spring catch** for swing doors.

z—**Spring catch**, beveled on one side only.

aa—**Disc and pin**.

ab—**Side pawl**.

ac—**Common latch**.

ad—**Cam locking bolt**

ae—**Crank-movement locking bolt**.

af—**Bolt of common lock**.

CLAMPING & LOCKING DEVICES

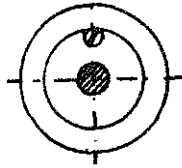

s

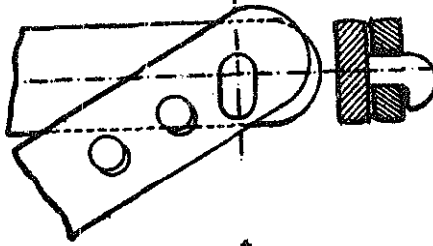

t

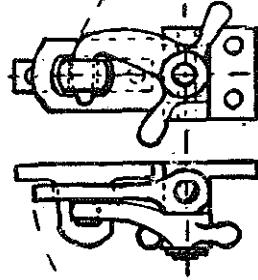

u



v

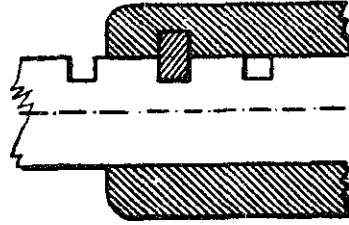

w

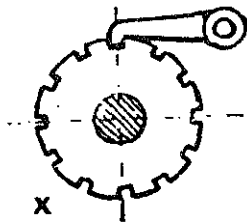

x

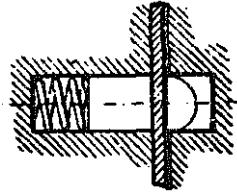

y

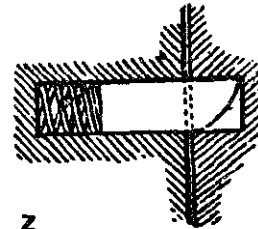

z

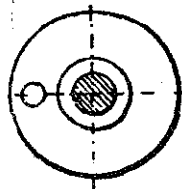

aa

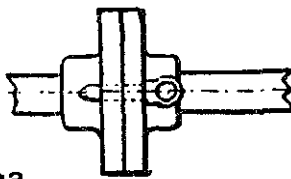

ab

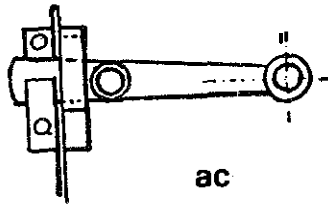
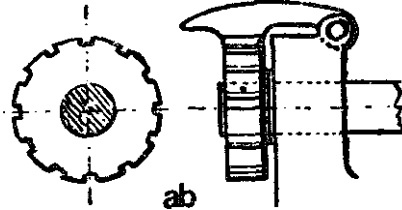

ac

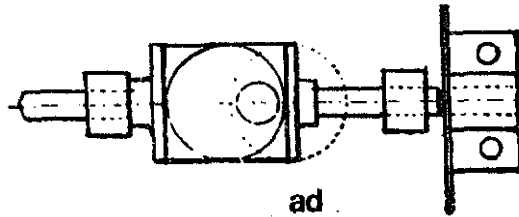

ad

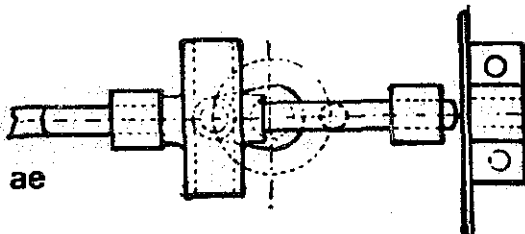

ae

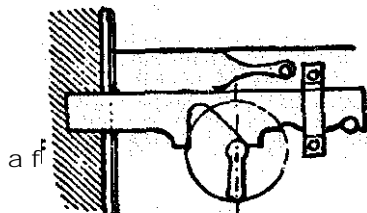

af

## E--Fastening and Fasteners

### 8-CLAMPING AND LOCKING DEVICES (cont)

- ag--Common sliding bolt.
- ah--Drilling-machine clamp.
- aj--Automatic bench clamp for work on flat.
- ak--Screw bench clamp for cabinetmakers.
- al--Automatic bench clamp for planing edges.
- am--Twisting a flat bolt.
- an--Rod or rope stopper with cam-lever grip.
- ap--Chain stop.
- aq,ar--Spindle grips.
- as--Clamp and screw.
- at--Sliding-shaft locking pin.
- au--Lever-locking hook.
- av--Bow catch for ladles.
- aw--Cross bar and hooks.

CLAMPING & LOCKING DEVICES

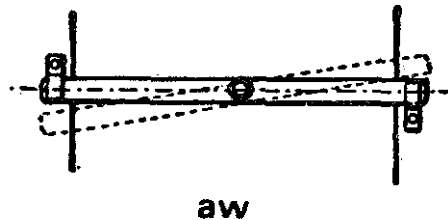
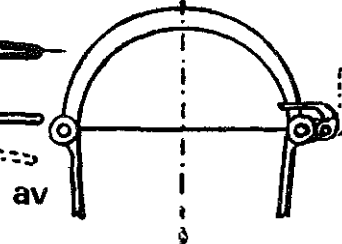
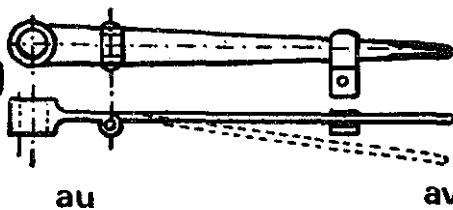
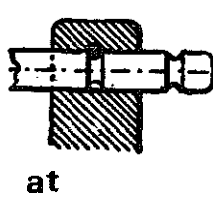
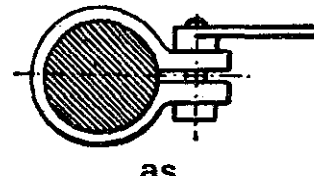
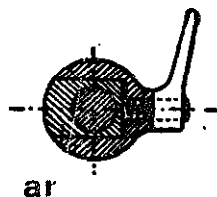
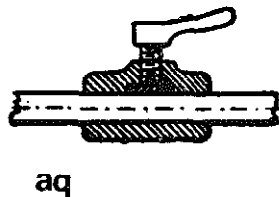
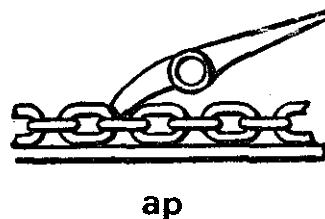
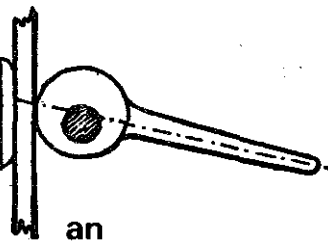
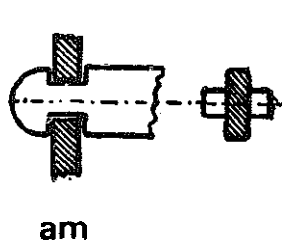
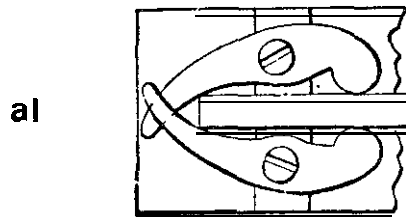
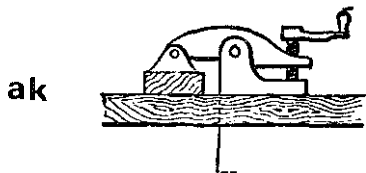
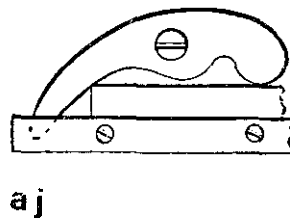
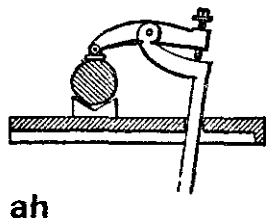
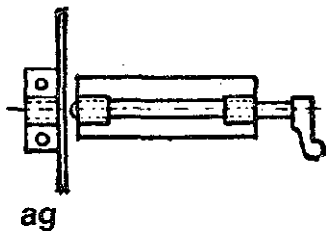

## E—Fastening and Fasteners

### 8—CLAMPING AND LOCKING DEVICES (cont)

**ax—Hand** setscrew.

**ay—T-catch.**

**az—Hasp and staple.**

**ba—Hook latch.**

**bb, bc—Hasp and staple.**

**bd—Trap-door automatic catch.**

**be—Screw and hook suspension.**

**bf—Spring-tud lock.**

**bg—Radial hinged-lever** and crown ratchet.

**bh—Locking bar** for fixing a lever in any position.

**bj—Crank-arm** device for locking a valve or lever in two positions.

**bk—Pawl** for locking sliding shafts; it is used for winches and has a double and a single purchase gear or shifting clutches.

**bl—Fastening** eye bolt.

**bm—Door-fastening** staple or cotter.

**bn—Common** cotter.



CLAMPING & LOCKING DEVICES

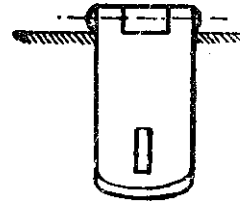
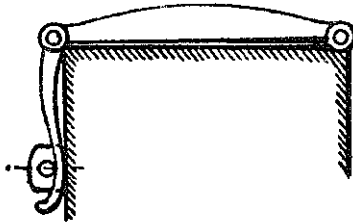
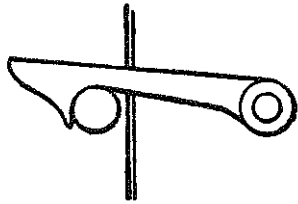
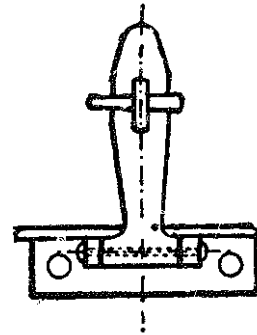
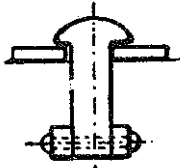
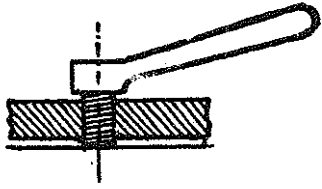

ba

ay

az

bb

bc

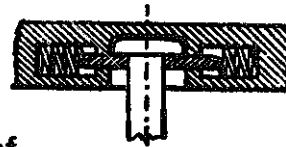
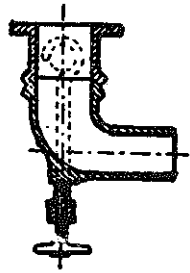
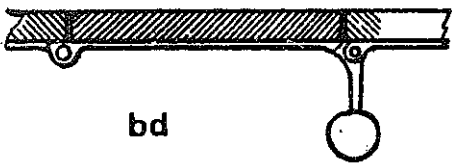

bd

be

bf

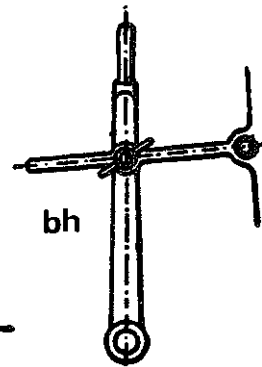
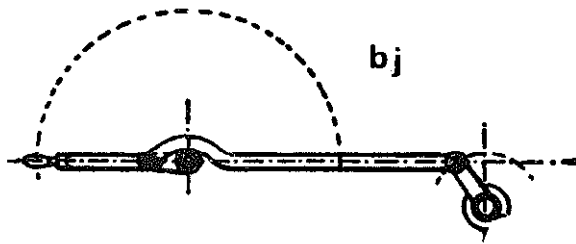
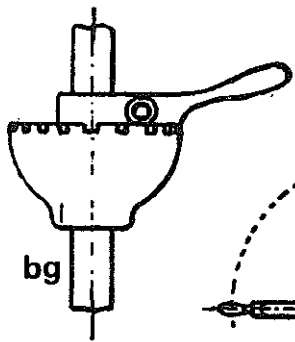

bg

bj

bh

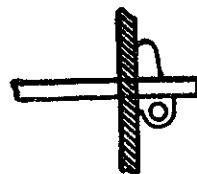
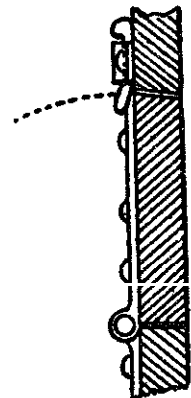
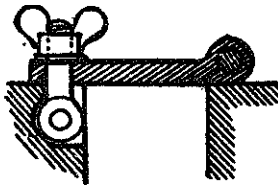

bk

bl

b m

bn

## E-Fastening and Fasteners

### S-CLAMPING AND LOCKING DEVICES (cont)

- bp**—Roller and inclined slot for locking a rope or rod.
- bq**—Revolving-bush lock.
- br**—Wire-fencing notches in angle or channel iron.
- bs**—Radius bar
- bt**—Horseshoe shifter to be placed between a sliding pinion and a shaft collar to keep them in or out of gear.
- bu**—Coned screw lock.
- bv**—Wing screw.
- bw**—Split block for gripping a rod.
- bx**—Cam catch for locking a wheel or spindle.
- by**—Locking gear for a shaft driven by spur gearing, used in place of a clutch.
- bz**—Locked nut.
- ca**—Spring-pawl umbrella catch.
- cb**—Spring snap.
- cc**—Locking pawl for spur teeth.
- cd**—Spring spindle.
- ce**—Spring pawl that locks a wheel against moderate force, but gives way to a greater force.
- cf**—Locking device for a lathe headstock or tool rest.

CLAMPING & LOCKING DEVICES

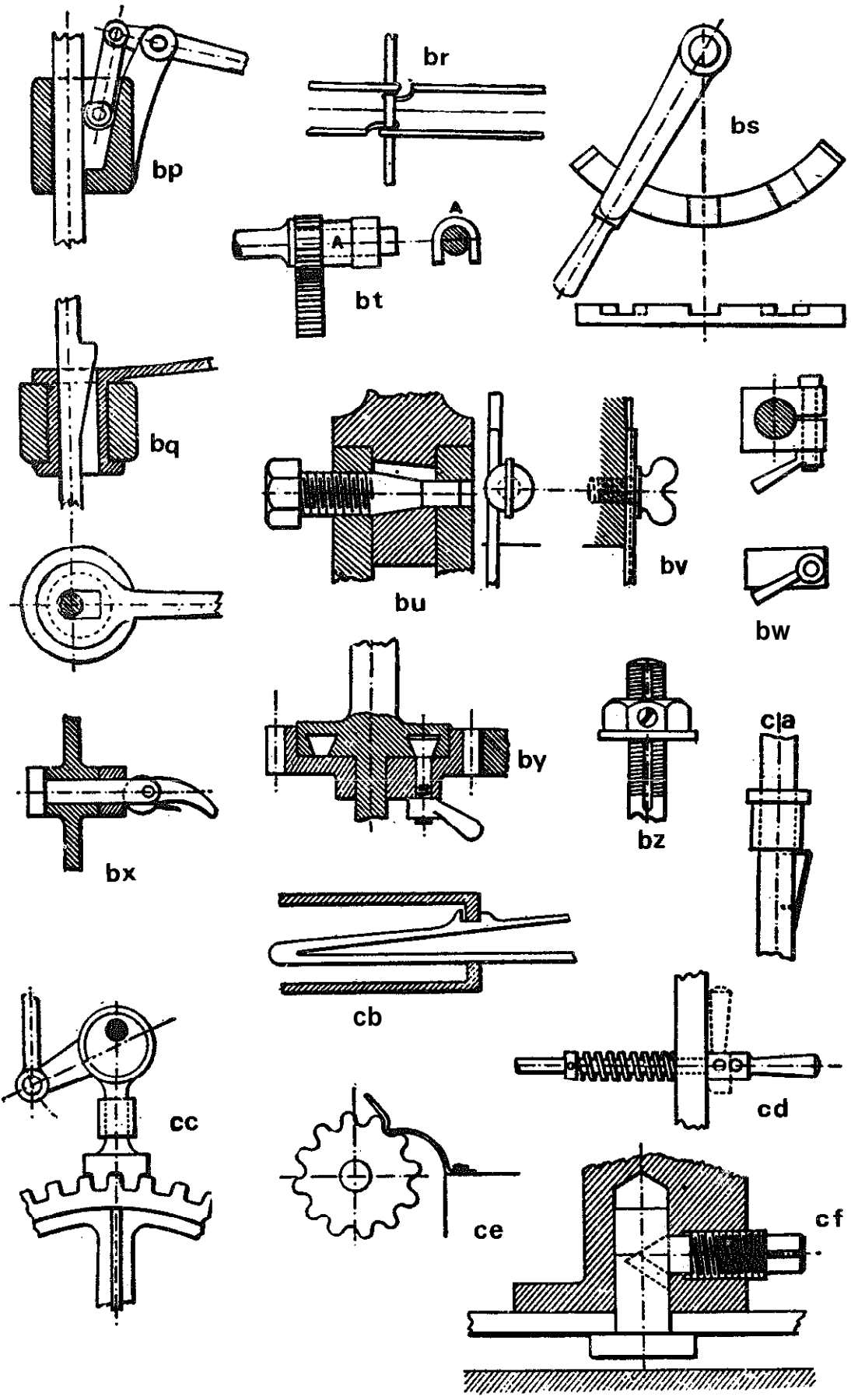

**E—Fastening and Fasteners**

9-HOLDERS AND GRIPS

**a—Elevating tool box** or tool rest.

**b—Tool holder.**

**c—Handle** for holding small tools.

**d—Turret** with cutting and boring tools.

**e—Sockets** for various tools with parallel or tapered holes; for parallel holes a key or setscrew is used.

**f—Adjustable tap wrench.**

**g—Lathe dog.**

**h—Tool box**, with two stool stocks and setscrews sliding in T-grooves in the slide rest.

**j—Tool box** with clamping screw and plate, which can be turned at any angle.

**k—Modification of “j”.**

**l,m,n,o,p—Clamping devices** for jigs.

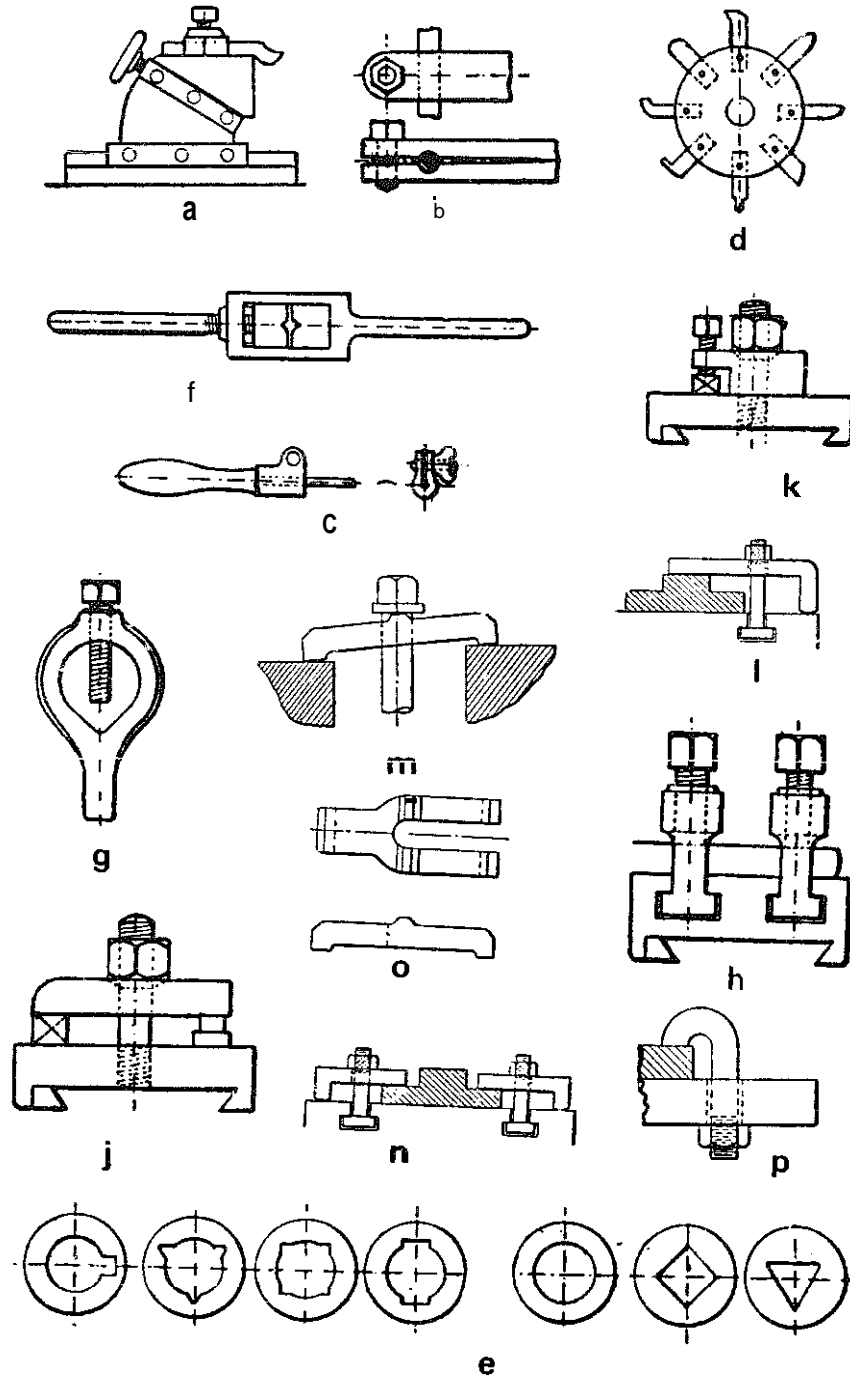

**E—Fastening and Fasteners**

9-HOLDERS AND GRIPS (cont)

- q—**Adjustable-grip holder** for bricks, etc.
- r—**Grapple** with shear pins for excessive strains.
- s—**Parallel-vice grip**.
- t—**Square-hole** central grip.
- u—**Tool-holder-gripping** device.
- v—**Spring grip** for small drills, pencils, pins, etc.
- w—**Split tool bar** with transverse cutter.
- x—**Socket** and setscrew for drills.
- y—**Split tool holder**.
- z—Simplest form of **V-grip**.
- aa—**Screw clamp**.
- ab—**Rod clamp**.
- ac—**Screw clamp**.
- ad—**Adjustable tool holder**.
- ae—**Toothed V-grip** for chucks.
- af—**Cam-clamp** for jigs.
- ag—**Gripping-dog** clamp for jigs.
- ah—Simplest form of **V-grip**.

HOLDERS & GRIPS

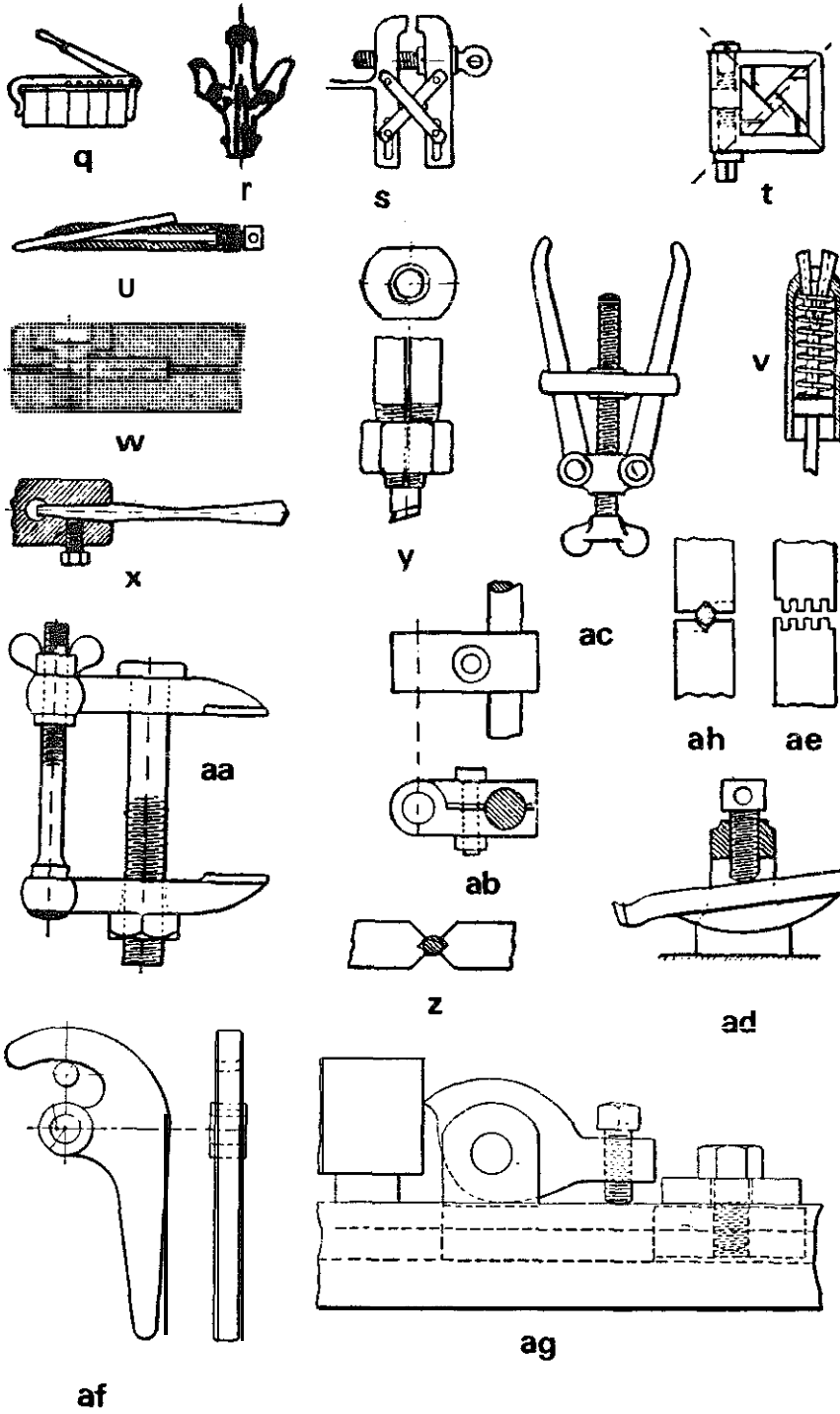

## E-Fastening and Fasteners

### 9-HOLDERS AND GRIPS (cont)

**aj**—Three jaw chuck, oid design.

**ak**—Connecting rod bearings in independent four jaw lathe chuck.

**al,am**—Eccentric strap **in** chuck. (Side views in first quadrant).

**an**—Chuck with four centering screws.

**ap**—Four jaw chuck.

**aq**—Chuck for wood turning. Internal threads shown in cross sectional view.

**ar**—Two jaw chuck. Left and right hand threads move jaws simultaneously.

**as**—Chuck for rings.

**at**—Fork chuck for wood turning.

**av**—Three jaw universal chuck.

**aw**—Cup chuck with taper feathers for wood.

**ax**—Three-jaw guide or chuck, the slide jaws being adjustable by screws.

**ay**—Brown and Sharpe adapter with cam lock.

**az**—Bell chuck with eight setscrews showing the connecting rod in working position.



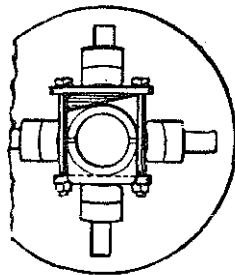

**ak**

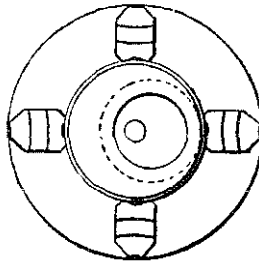

**al**

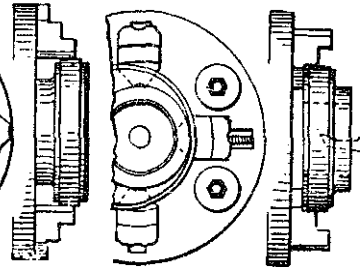

**am**

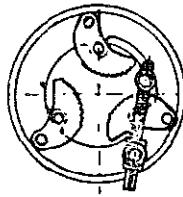

**aj**

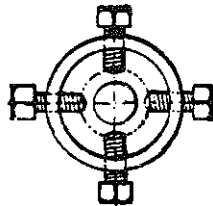

**an**

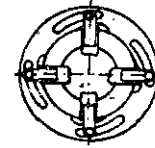

**ap**

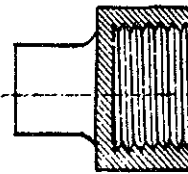

**aq**

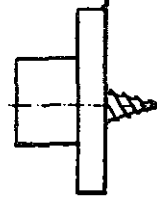

**au**

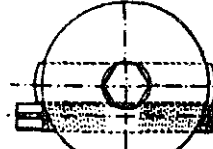

**ar**

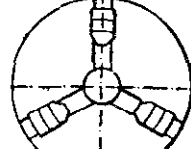

**av**

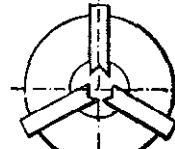

**ax**

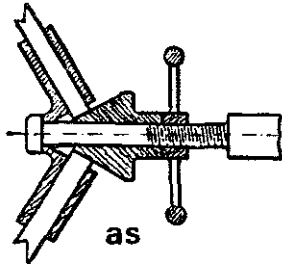

**as**

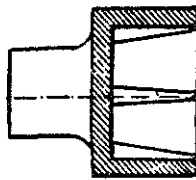

**aw**

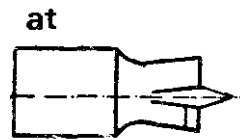

**at**

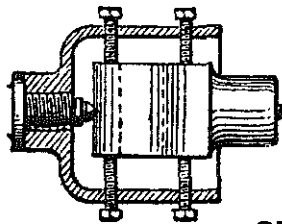

**az**

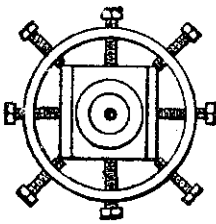

**ay**

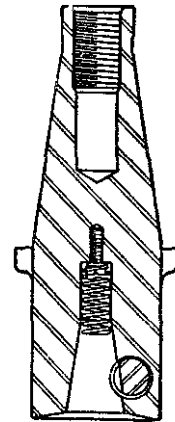

## E—Fastening and Fasteners

### 9-HOLDERS AND GRIPS (cont)

**ba**—Cone **and** screw lever **grip**, with two or more jaws; with two jaws only, it serves as a small vice.

**bb**—**Taper** grip for vices.

**bc**—**Rail** grip.

**bd**—**Cam-lever** grip for safety gear on inclines; usually thrown into action by a spring released by breakage of the hauling rope.

**be**—**Cone-centering** grips for machine tools.

**bf**—**Hinged clamp** with screw and nut.

**bg**—**Fitter's** clamp.

**bh**—**V-grip** for round rods and tubes.

**bj**—**Bench** clamp.

**bk**—**Grip** tongs.

**bl**—**Split-cone** expanding chuck.

**bm**—**Expanding** mandrel.

**bn**—**Three-jaws** grip or steady rest for long shafts or spindles.

**bo**—**Collar grip** with locking bolt.

**bp**—**Cam lever grip**.

**bq**—**Cable-railway** grip; showing the grip wheel and the hand wheel.

**br**—**Automatic disengaging** grip for a pile driver.

**bs**—**Wire-rope** grip pulley having wedge action.

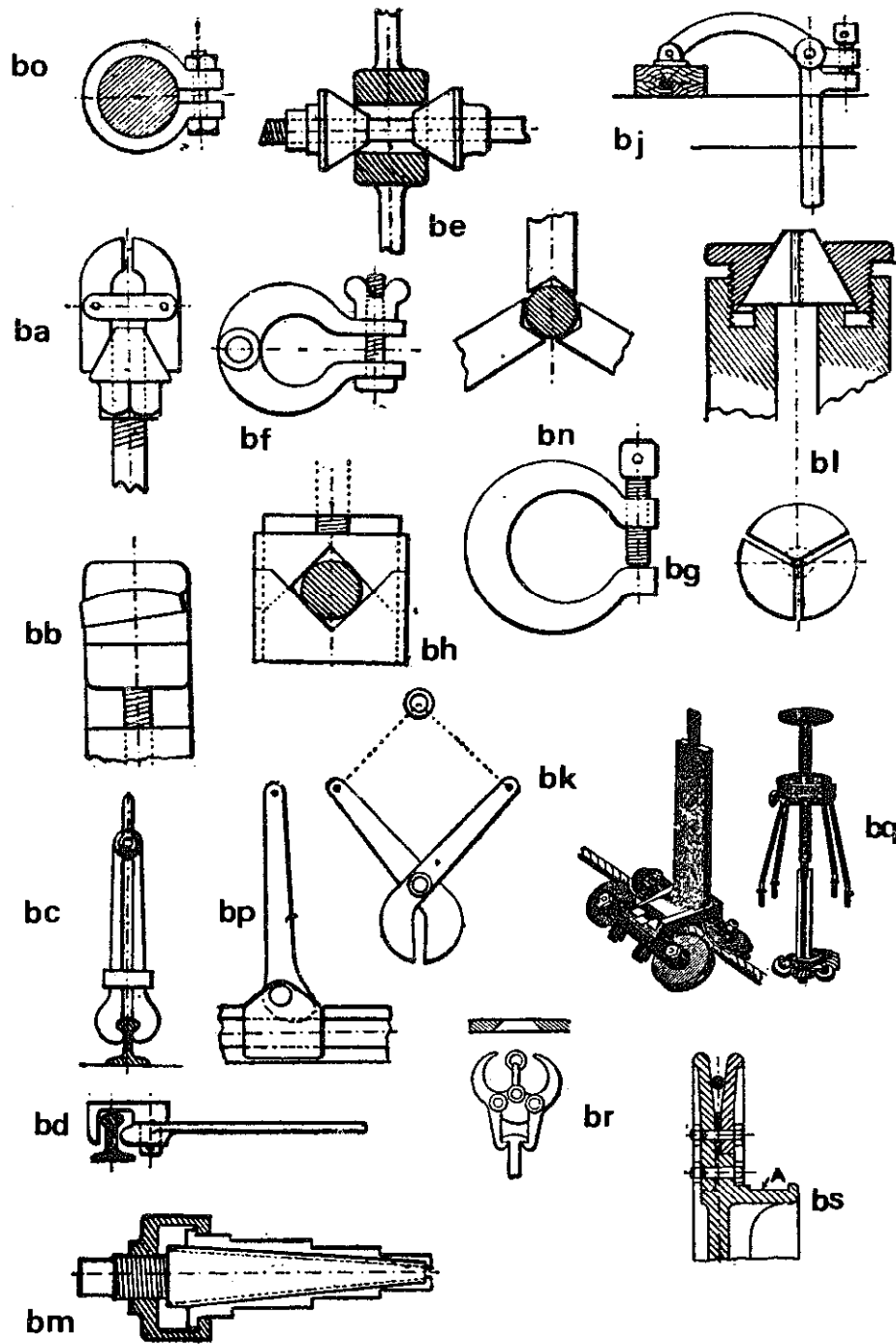

E—Fastening and fasteners

9—HOLDERS AND GRIPS (cont)

**bt**—Pipe tongs.

**bu**—Paper grip, released by striking a stop **A** at any point of its travel.

**bv**—Self-adjusting jaws for round work.

**bw**—Adjustable gripping tongs.

**bx**—Double-screw gripping tongs.

**by**—Instantaneous grip for vice; the worm **A** is eccentric, and raises or lowers the toothed block **B** into or out of gear with the fixed rack by a single movement of the handle.

**bz**—Split sleeve and nut for gripping a rod.

**ca**—Spring taper socket with sliding ring.

**cb**—Cap and socket for drills.

**cc**—Stepped jaw for lathe-face chucks.

**cd**—Spanner. (Bauer)

**ce**—Split-end grip for rods.

**cf**—Hand screws for V-grips.

**cg**—Double V-grip for pipes.

**ch**—Central grip, thread **A** being one half pitch of thread **B**.

**cj**—Eccentric clamping lever for jigs, etc.

**ck**—Wrench grip.

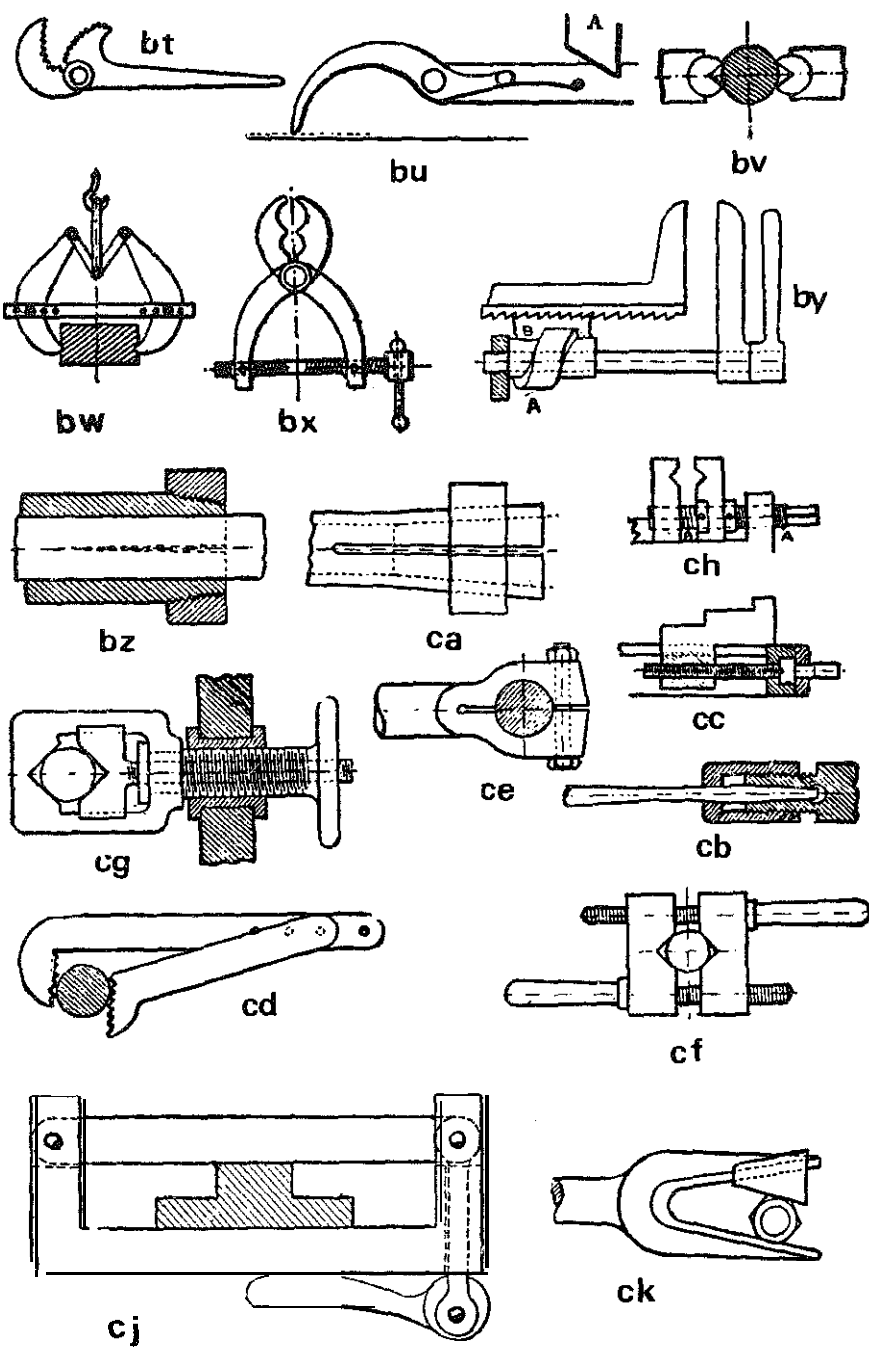

## E—Fastenings and Fasteners

### IO-MISCELLANEOUS

a—Miscellaneous **internal and external** retaining rings. (Industrial Retaining Ring Co.)

**b—Weatherseal sealing** head has plastic sealant on underside. Tightening drives sealant down and inside. (Lamson and Sessions Co.)

**c—Wire coil insert** for soft materials. (Heli-Coil Products Div. Heli-Coil Corp.).

**d—Wire clip**, quarter turn fastener. Needs no mating part. (Simmons Fastener Corp.)

**e—Stud type assembly**. Shear loads being carried by bushing, let stud free to move up or down. (Camlock Fastener Corp.)

**f—“Supersonic”, quarter turn fastener** using spiral cam and receptacle. (Dzus Fastener Co., Inc.)

**g—90° turn fastener**. This type uses captive nut on inner plate. (Simmons Fastener Co.)

**h—Drive Rivet**, before and after expanding of rivet. Pin is driven in by hammer.

**j—Quarter-turn fastener** having spiral cam and mating spring. Stud is held captive by grommet.

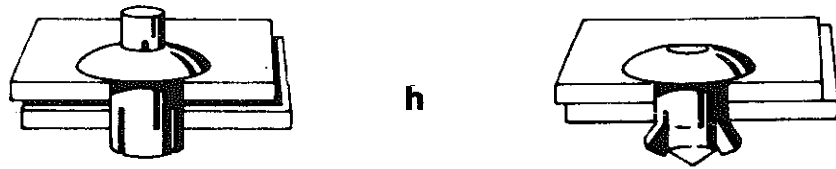
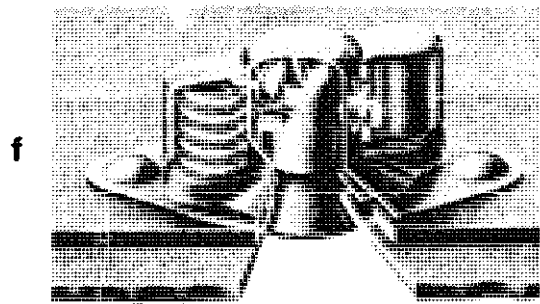
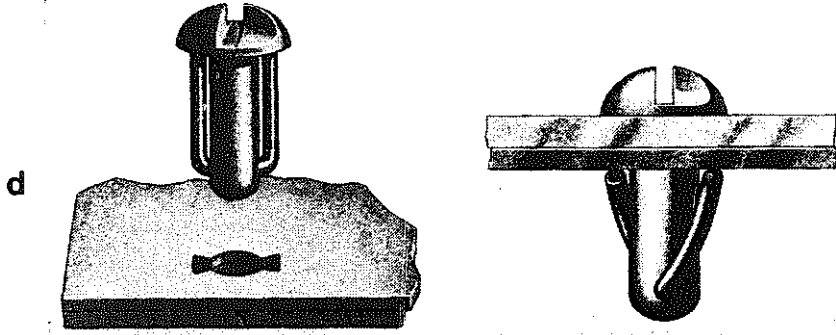
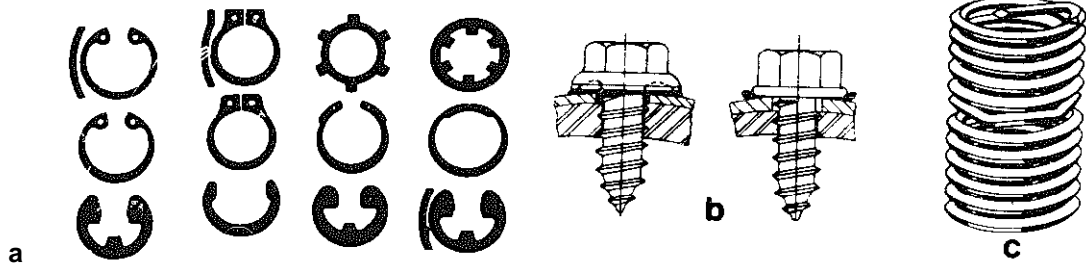

## E-Fastenings and Fastener

### 10-MISCELLANEOUS (cont)

**k,l**—**Three part quarter,turn** fastener. Shown open and locked. Spring unit attaches to bottom side of lower plate. (Fastex Div., Illinois Tool Works, Inc.)

**m**—**Drive** screw, rotates into position when hammered

**n**—**Annular threaded drive** screw does not rotate during installation

**p,q**—**“Well-Nut” insert**. On tightening of screw the neoprene sleeve distorts, anchoring brass nut. (Rockwell Products Corp.)

**r**—**“Conoe” clip, fastener**, snaps into place by finger pressure. (Shakeproof Div. Illinois Toolworks)

**s**—**“Air loc” quarter** turn fastener. Receptacle is riveted to panel. (Cinch Monadnock Div., United Carr Fastener Corp.)

**t**—**Self-tapping, self-locking** insert, for soft metals. (Groov-Pin Corp.)

**u**—**One piece clamp** fastener and applications. (Tinnerman Products Inc.)

**v**—**Slide snap** fastener. (Dimco-Gray Co.)

**w,x,y,z**—**Quick acting** fastener. Shown is “w” insertion, “x” initial engagement, “y” locked position, “z” released position. When the screw is turned, nut halves move up into smaller receptacle section until locking occurs. Stud trips two right angle engagement levers to help this process. Procedure is reversed for disengagement. (Waldes Kohinor, Inc.)



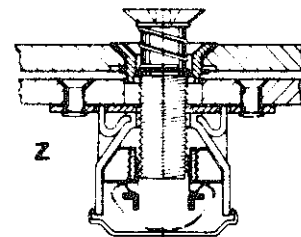
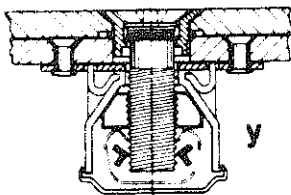
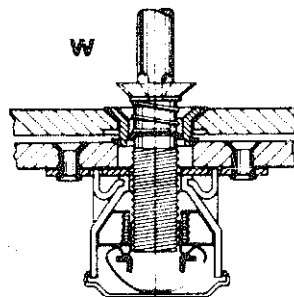
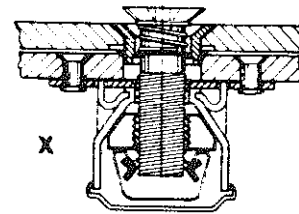
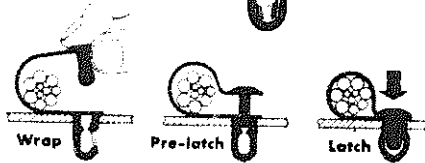
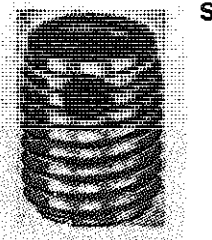
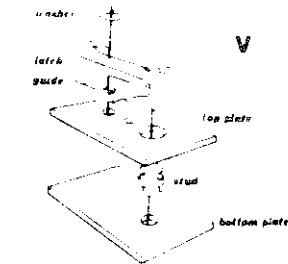
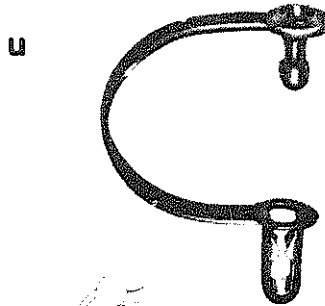
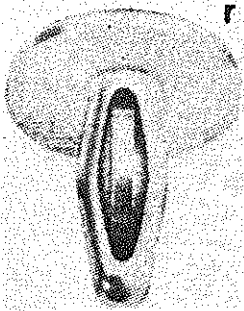
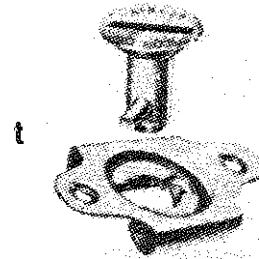
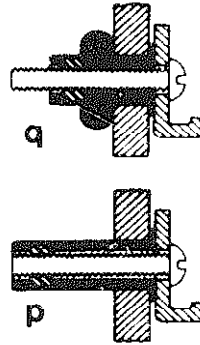
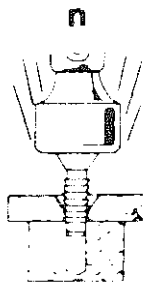
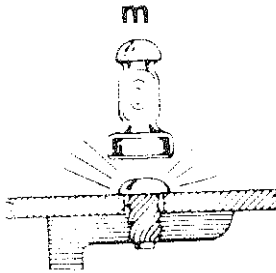
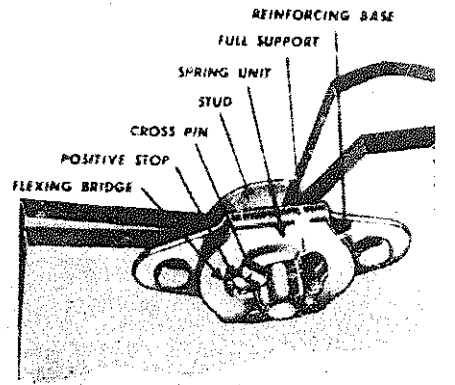
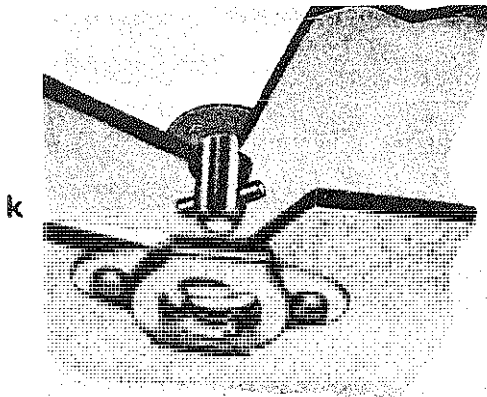

## II MAGNETICS AND ELECTRONICS

## A—Magnetics

I-MAGNETISM. Magnetism is the name for a class of physical phenomena, that includes the attraction of iron. It is characterized by fields of force in which both, magnets and electric currents experience mechanical forces.

a-Arrangement of **magnetic domains** in an iron bar **before** magnetization. Note: Iron and steel consist of submicroscopic particles, called domains. They are elementary magnets that lie in a random way before magnetization.

**b--Iron bar after** magnetization. The domains are forced to occupy systematic positions with one pole in one direction, the other one in the opposite direction.

**c--Magnetic field** around a bar magnet.

**d--Unlike poles** attract. Note: poles are always in pairs.

**e--Like poles** repel,

f-The **magnetic field of the earth**, showing the North and South poles, and the magnetic lines.

**g--Magnetic compass.** Light steel needle, magnetized and mounted on a sharp point, will point approximately in a North-South direction.

**h--Magnetic induction** with and without contact.

**j,k--Magnetostriction.** Lining up the domains by magnetizing, brings about a change in length and width, not noticeable to the unaided eye, but used in instrumentation.



a

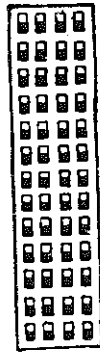

b

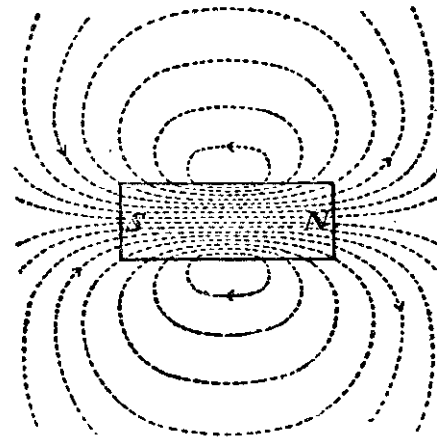

c



d

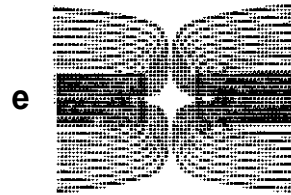

e

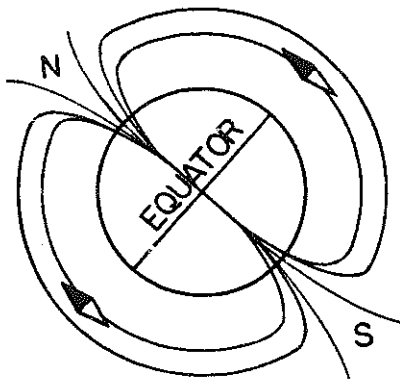

f

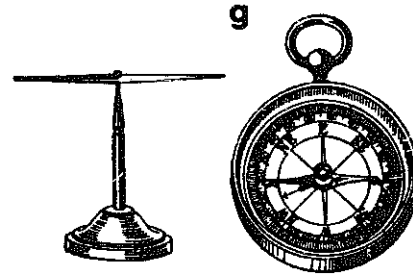

g

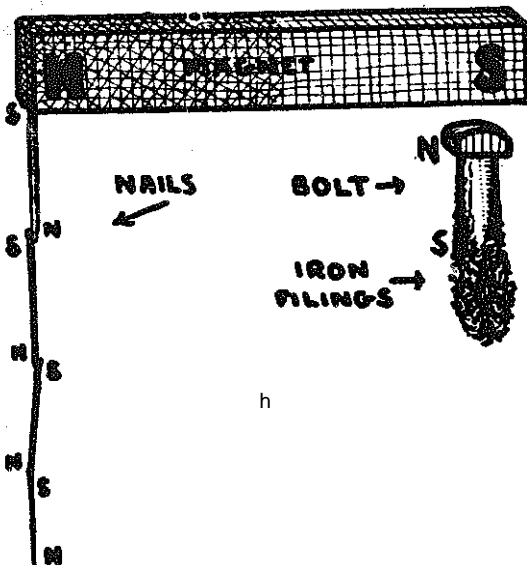

h

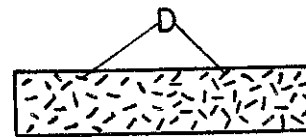

j

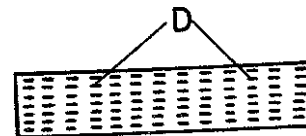

k

A—Magnetics (Cont)

2-PERMANENT MAGNETS

**a—Simple bar** magnet.

**b—U-shape** magnet.

**c,d—Other arrangements** of two poles to produce similar results to “b.”

**e—Soft-steel plates** are north or south around the entire periphery; this arrangement may be used as a role for handling sheet metal.

**f—Simple air gap** made to definite dimensions.

**g,h,j—Simple air gap** made to definite dimension with soft-steel pole pieces.

**k,l,m—Soft-steel return** circuit.

**n,o,p—Magnet surrounding an air gap**; used where the available space is limited.

**q—Two magnets** placed together to form a double air gap, the direction of flux being opposite in each air gap.

**r—Air gap** at either end.

**s—Annular air gap.**

**t,u,v—Other annular combinations.**

**w—Rotating magnet** with two poles.

**x,y,z—Built-up rotors.**

**aa—Four-pole rotating** magnet; it is often desirable to use soft-steel poles on magnets of this type.

**ab,ac,ad—Built-up four-pole rotors** with soft-steel poles.

**ae—Cylindrical magnet** magnetized with poles about the periphery; this is possible only with modern permanent-magnet materials.

**af—A variation of “ae.”**

**ag—Poles on the inside of a ring.**

**ah,aj,ak—Magnets** which can be made with any desired number of poles.

**al to ax—Fundamental types of air gaps.**

PERMANENT MAGNETS

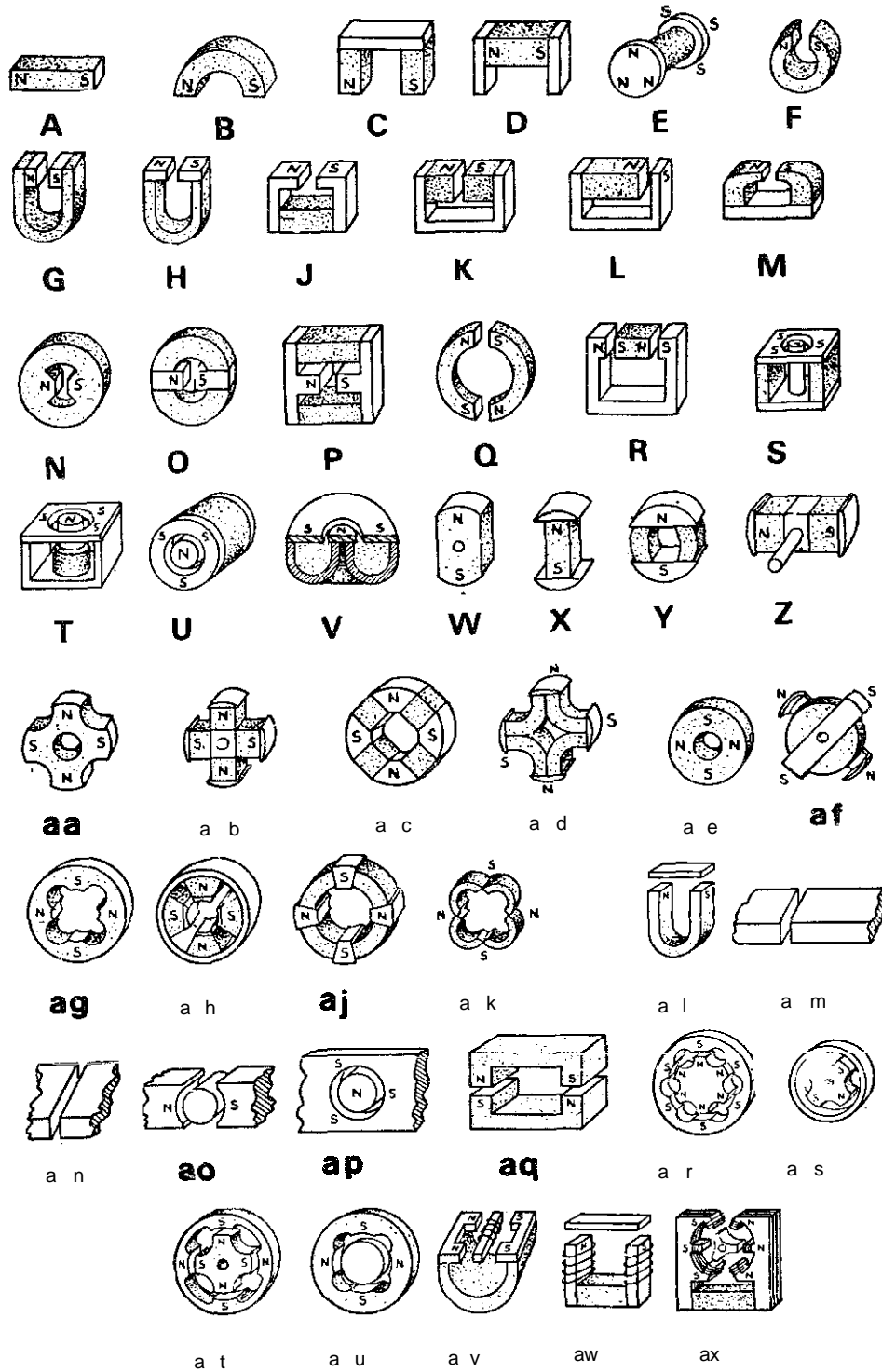

## A—Magnetics

### 2-PERMANENT MAGNETS (Cont)

**ay**—**Magnetic field** of two magnets, helping.

**az**—**Magnetic field** of two magnets, opposing each other.

**ba**—The pieces of a broken magnet become themselves small magnets.

**bb**—Difference of magnetic field intensities of magnets of the same length and cross section, but of different shapes.

**bc**—The **magnetic lines** around a simple bar magnet are directed from North pole to South pole.

**bd,be,bf**—**Domain position** in a steel bar under various degrees of magnetization; nonmagnetized, partially magnetized, fully magnetized.

**bg**—**Demagnetization** curves on the left, and B X H product curves on the right for various hard magnetic materials. A is Alnico V; B is for Alnico II; C is for cobalt steel; D for tungsten steel; E for carbon steel.

**bh**—**Loadstone** L shows the presence of magnetic poles  $P_1$  and  $P_2$  by the cluster of iron filings.

**bj**—**Magnetization** of steel bar N'S' through flux lines of permanent magnet N-S.

**bk**—**Hysteresis loop**. Curve taken by continuously increasing magnetizing force, starting from zero. Energy is applied until maximum is reached. As current is decreased magnetization curve does not follow previous curve but shows higher values of magnetism for equal **values** of current. The difference between the two amounts of energy is energy lost in the hysteresis cycle.

PERMANENT MAGNETS

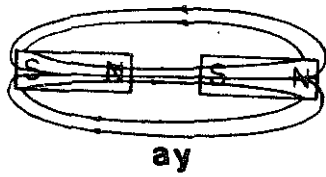

ay

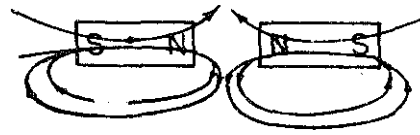

az



ba

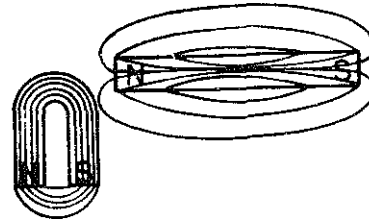

bb

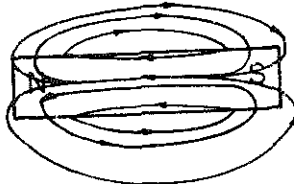

bc



bd

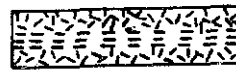

be



bf

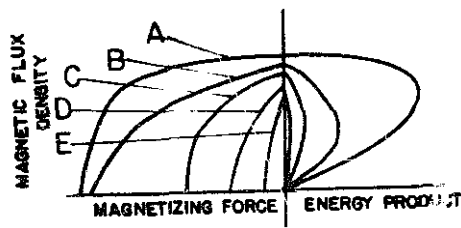

bg

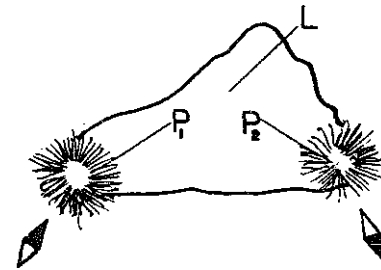

bh

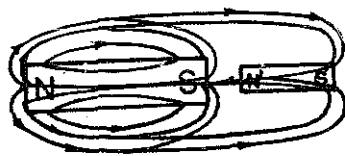

bj

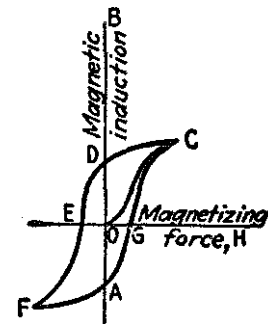

bk



## A-Magnet &

3-ELECTROMAGNETS. If a bar of iron is inserted into a current carrying coil, the field of the iron magnet will be added to that of the coil, producing a much stronger magnetic field. A magnet produced in this way is called an electromagnet.

**a—Simple electromagnet.**

**b—Iron filings** in a magnetic field about a conductor carrying a current.

**c—Right-hand thumb rule;** thumb shows direction of current; fingers show direction of magnetic lines of force. The current is going from plus to minus, or in a battery away from the positive terminal and back to the negative terminal.

**d—Reversed right-hand thumb rule;** fingers show direction of current in the turns of wire and the thumb indicates the north pole of the electromagnet.

**e—Horseshoe electromagnet;** coils of insulated wire around a soft iron core; an electric current flowing through the wire forms a magnet of greatly increased strength.

**f—Electric bell;** the armature is fastened to a spring which is so adjusted that its tension is sufficient to maintain the armature in contact with a screw when no current is flowing; when the button is pushed, the electromagnet is energized and attracts the armature, thus ringing the bell; as the armature moves toward the magnet, the circuit is broken; the spring pulls the armature back to make contact with the screw and the process is repeated.

**g—Electric-bell circuit.**

**h—Telegraph key;** it consists of a lever and two contact points; when the lever is pressed, the circuit is closed; when the lever is released, the circuit is broken.

**j—Sounder;** a device for making clicks; when the key is pressed, the circuit is completed and the electromagnet attracts the armature and is struck, making a clicking sound; when the key is raised, the circuit is broken, the armature is released, and the spring pulls the lever *B* up, making another click.

**k—Telegraph relay;** it consists of an electromagnet which responds to weak electric impulses and passes messages on to a strong local current which operates a sounder.

**l—Complete telegraph system.**

# ELECTROMAGNETS

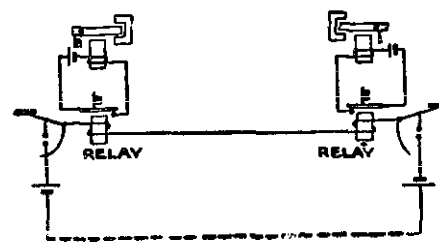
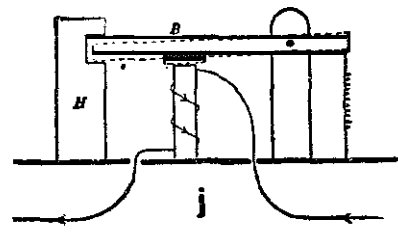
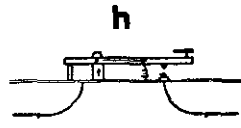
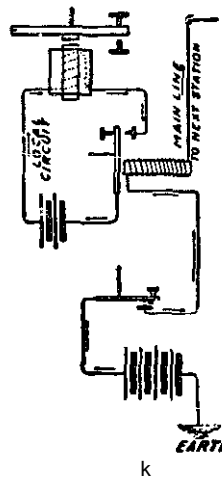
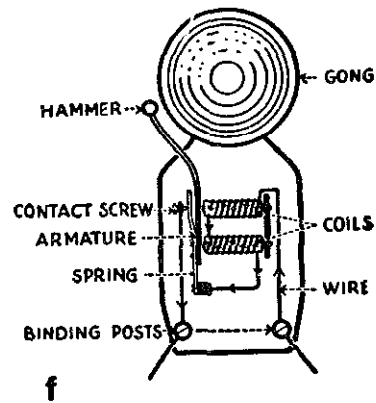
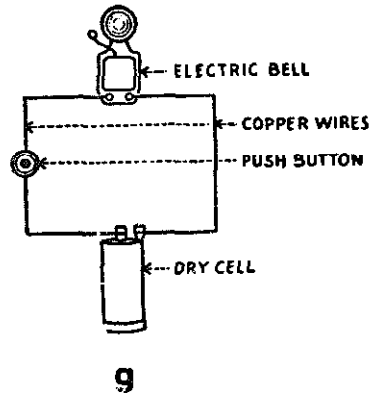
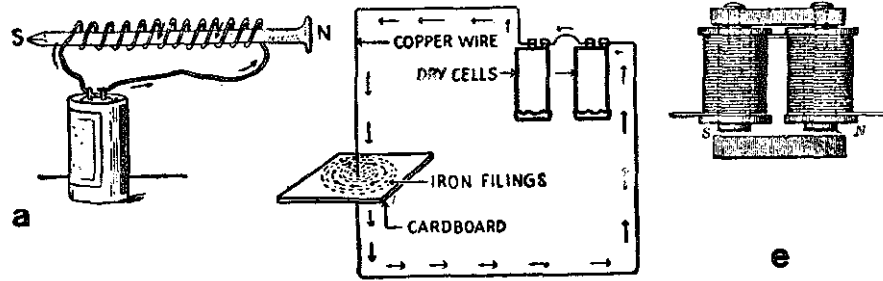

## B-Electricity

1-STATIC ELECTRICITY. Static electricity is concerned with charges at rest. We have two kinds of charges. Like charges repel each other, as unlike charges attract.

a-Proof plane; used when testing a body for electrification, which is too heavy or inconvenient to carry to the electroscope; a copper penny is waxed to the end of a glass or rubber rod; by touching the penny alternately to the body and to the electroscope, it can be determined whether or not the body is charged.

b-**Charging by induction:** a body may acquire an electrical charge by contact with another body. The negatively charged rod attracts the positive charges at b, and pushes the negative charges toward a. Finger, by touching body c, picks up negative charges.

c--**Electric field** around a sphere.

d--**Electric charge** accumulates on the outside of a hollow conductor.

e--**Electric charge** accumulates near the pointed end of a body.

f--**Electroscope** measuring potential.

g--**Plate condenser.** The number of plates, size of plates and their spacing determine the capacitance, the property to store electric energy.

h--**Simplest** type of capacitor consisting of two parallel plates.

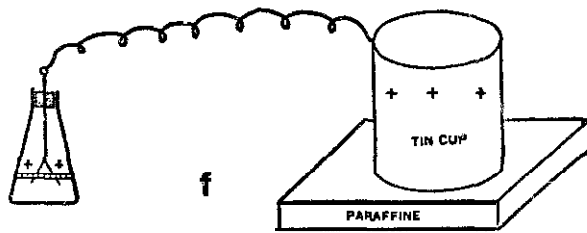
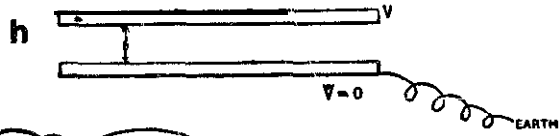
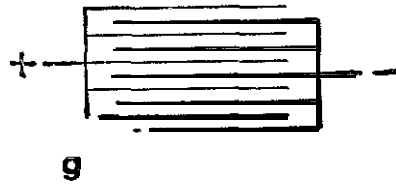
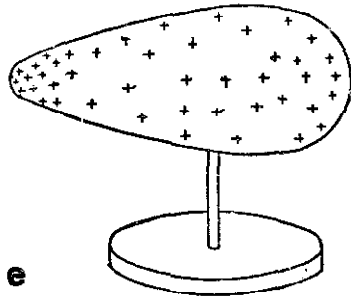
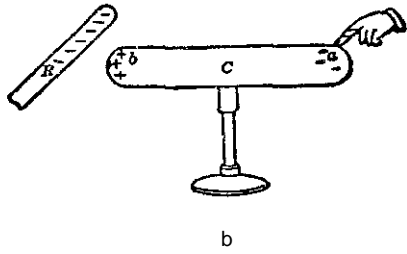
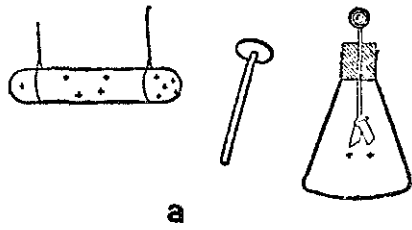

## B—Electricity

### 1-STATIC ELECTRICITY (Cont)

**j—Positive and negative** electricity; when glass is rubbed with silk, it becomes positively charged; when sealing wax or gutta percha is rubbed with flannel, it becomes negatively charged; like charges repel, unlike attract each other.

**k—Electrophorus**; it consists of a hard-rubber plate *P*, which can be electrified by friction and a metal disc *C*, which has an insulated handle *H*, and which is called a carrier; the hard-rubber plate *P* generally rests on a metal plate *S* which is called the sole plate; rubbing the plate with fur charges it negatively.

**l—Electroscope**; used for detection of an electric charge; it consists of a metal rod supported by a stopper of sealing wax or sulfur and carrying two leaves of aluminum or gold foil suspended from its Lower end, the leave; and rod being enclosed in a glass flask; if an electrified body is brought into contact with the metal ball on the end of the rod, the gold or aluminum leaves will diverge, since they become similarly charged and repe! each other, the amount of repulsion being a measure of the strength of the charge.

**m,n,p—Charging the electroscope**; *m*, to charge it negatively by induction, bring a positively charged rod near the knob, the leaves diverge; *n*, holding the rod near the knob, touch the knob with the finger and the leaves collapse; *p*, withdraw first the finger then the rod and the leaves **u**iverge, being negatively charged.

# STATIC ELECTRICITY

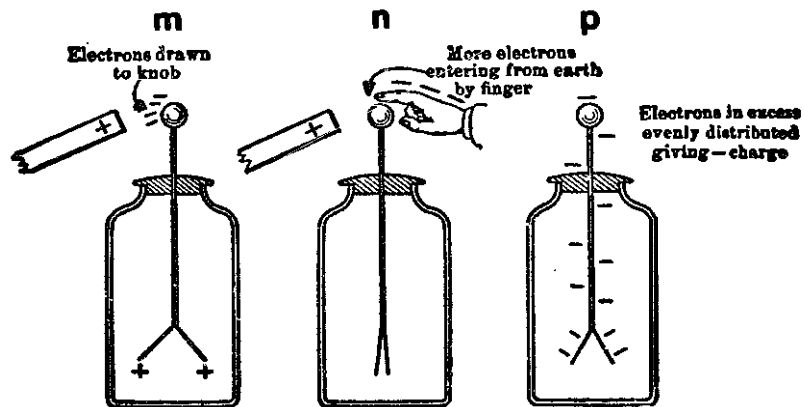
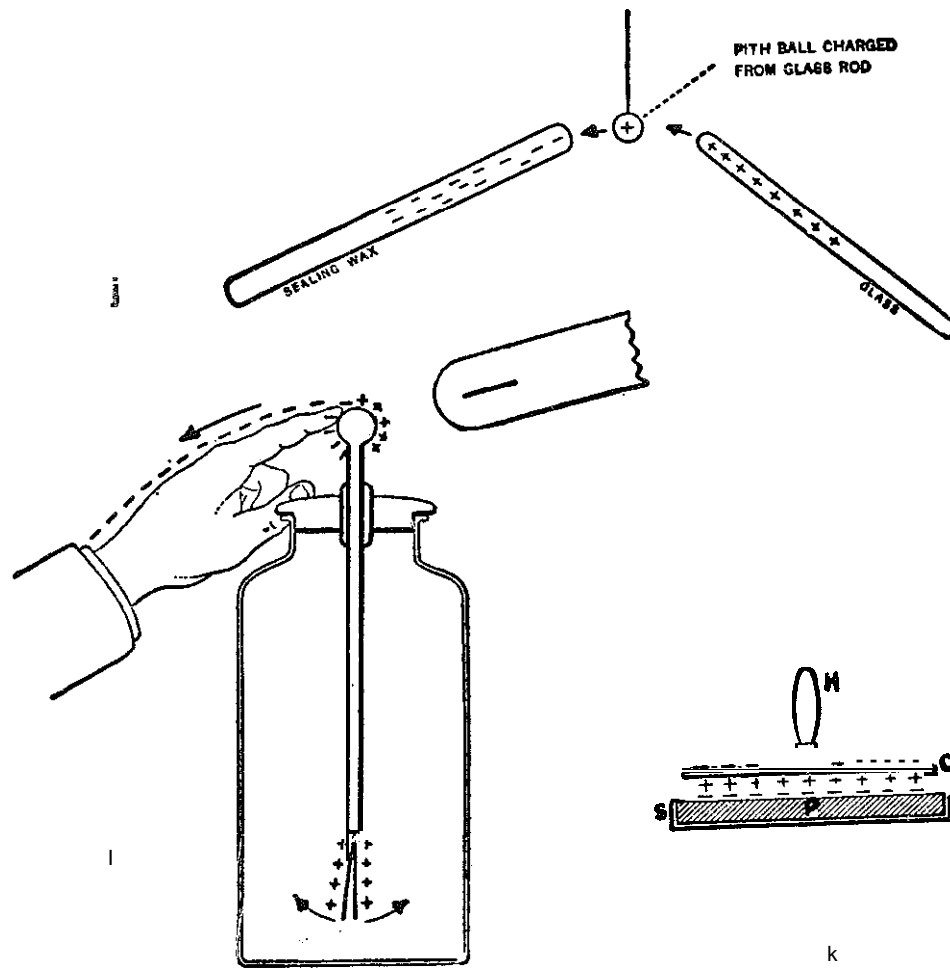

## B-Electricity

### 2-BATTERIES

a-Various parts of a **voltaic** cell. The cell has a zinc anode, a copper cathode and sulphuric acid as an electrolyte.

**b-Voltaic** cell connected to a bell.

c-Local action; commercial zinc contains metallic impurities and when placed in an acid, small electric currents are set up between two different metals, causing local action or corrosion.

d-Polarization; a defect caused by bubbles of hydrogen gas accumulating on the positive plate of a battery.

e-Gravity cell. A form of a voltaic cell with a zinc electrode in a zinc sulfate solution at the top, and a copper electrode in a copper sulfate solution at the bottom. The fluids do not mix due to the difference in specific gravity.

**f-Weston standard** cell; it produces a constant electromotive force and is used as a standard of measurement.

**g-Leclanché dry** cell. A zinc-carbon primary cell whose exciting liquid is a solution of sal ammoniac.

h-Battery of cells in series. The voltages are added. If each cell is 1% volts, we have 6 volts available.

**j-Battery** of cells in parallel. The voltage does not change, but more **current** is available.

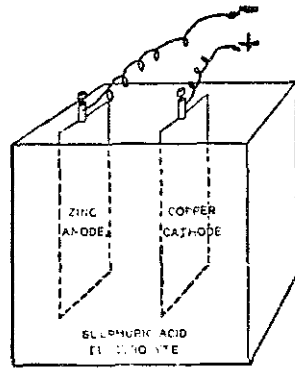

a

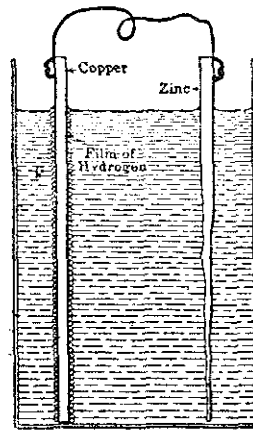

d

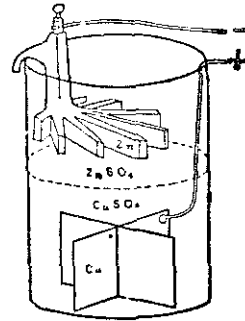

e

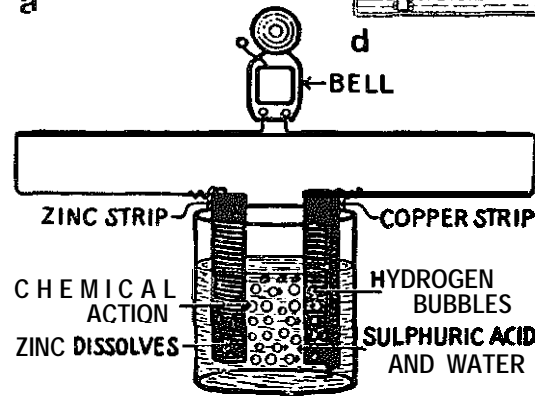

b

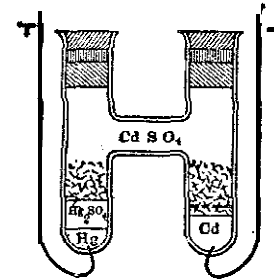

f

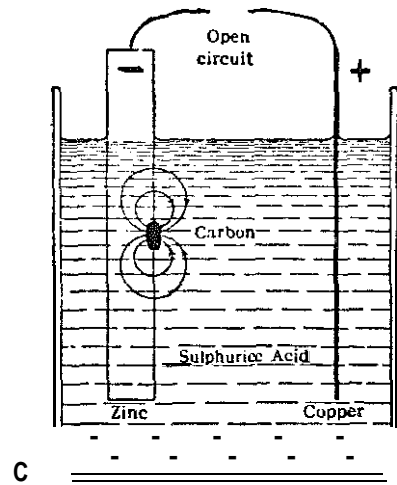

c

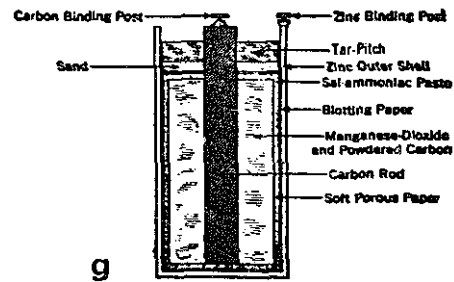

g



h

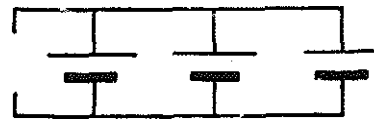

j



## B—Electricity

3-CHEMICAL EFFECTS OF ELECTRICITY. When charges flow through a liquid, not only is there a transfer of material, but also a chemical change in the liquid.

**a—Electrolysis of water;** when a direct current flows through a solution of sulfuric acid diluted with water, hydrogen accumulates at the cathode and oxygen at the anode.

**b—Copper plating;** the object to be plated is connected to the cathode and a plate of copper serves as the anode. The copper is dissolved from the anode and deposited on the cathode, the spoon serving as cathode.

**c—Charging a storage battery;** the positive plates become coated with lead peroxide; the negative plate becomes spongy lead.

**d—A storage battery** discharging direct current; the positive plate releases oxygen, lead peroxide changing to lead sulfate; the negative plate becomes coated with lead sulfate; the sulfuric acid becomes more dilute.

**e—Electrolytic copper** refining; impure copper is used as positive electrodes and strips of pure copper as negative electrodes; when a direct current is passed through the cell, copper of the positive electrodes goes into solution and pure copper is deposited on the negative electrodes; impurities, including gold and silver, settle to the bottom.

**f—Charging a battery** with constant 1 10-volt direct current; several batteries may be connected in series; the lamp bank offers series resistance.

**g—Silver plating;** it is similar to copper plating; the solution consists of silver nitrate and potassium cyanide; the object to be plated and a strip of pure silver are dipped into the solution and connected to a current supply; the object to be plated is charged negatively and the silver sheet positive.

**h—Downs cell** for making sodium from sodium chloride; the positive electrode made of graphite projects through an iron box lined with fire brick; the negative electrode is a band of iron or copper which encircles the graphite separated by a wire gauze; sodium is produced from the fused salt (600°F) at the negative electrode and flows into the receiver C; chlorine, a valuable by-product, is collected at B; sodium chloride is added from time to time at A and is kept in a molten state by its resistance to the flow of the electric current.

# CHEMICAL EFFECTS OF ELECTRICITY

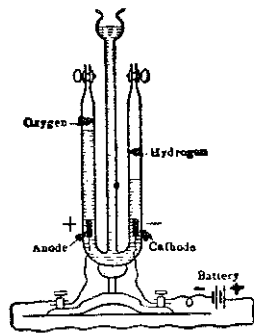

a

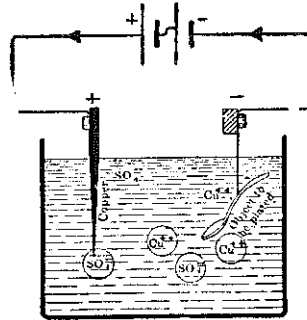

b

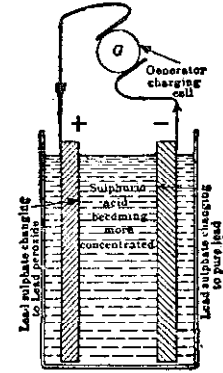

c

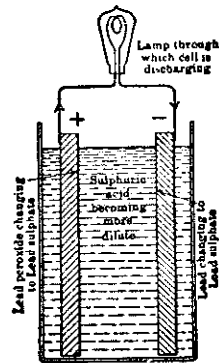

d

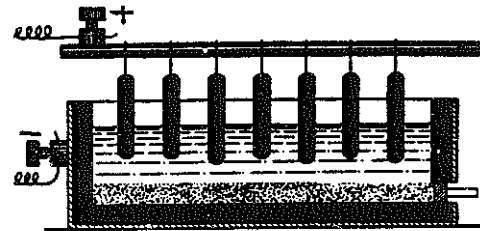

e

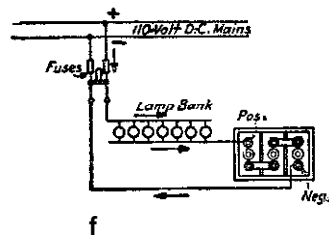

f

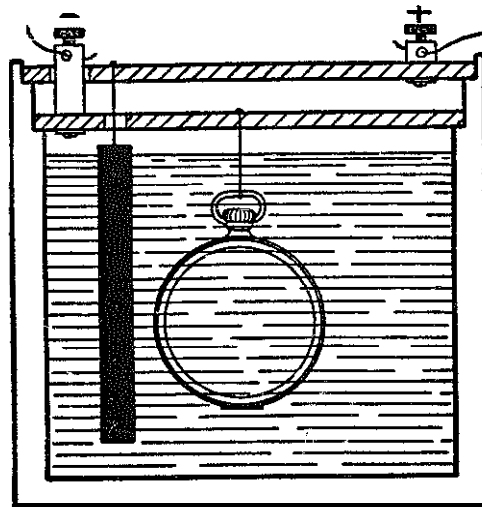

g

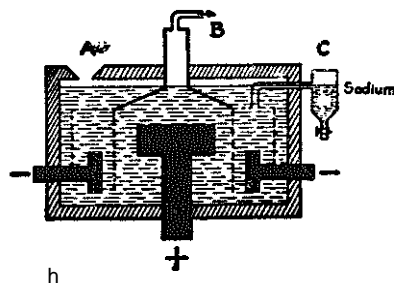

h

**B—Electricity**

4-INFRARED HEATING

**a—Open reflector;** gold plated or made of aluminum.

b-Closed **reflector;** vaporized aluminum.

**c—Reflector-type lamp;** vaporized aluminum.

**d—Tunnel design;** mounted over a slat conveyor for heating fairly large objects.

e-Tunnel design for heating a flat surface on a conveyor.

f-Tunnel design for heating small parts on a conveyor.

g-Method of heating a long suspended object.

h-Parabolic reflector emitting parallel rays.

j-Circular source at focus; reflector rays are redirected toward the center.

**k—Elliptical reflector;** the rays are redirected through the other focus.

**l—Circular reflector;** the source out of focus.

**m—Paracyl** (combination of parabolic and circular) reflector.

INFRARED HEATING

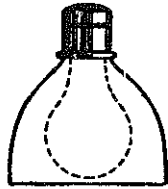

a

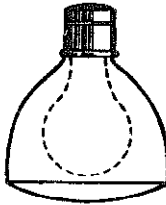

b

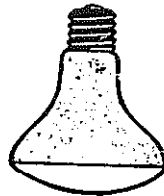

c

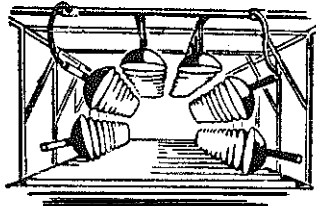

d

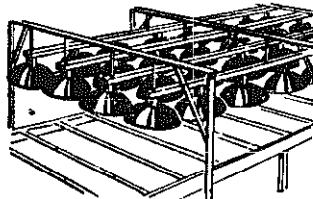

e

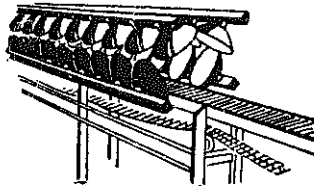

f

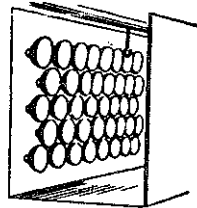

g



h



i



m

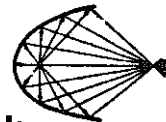

k

**B—Electricity**

S-ELECTRICAL HEATING

- a—**Portable** radiant electric heater.
- b—**Radiant heater** recessed in the wall.
- c—**Large industrial-type** fan unit electric heater.
- d—**Large industrial-type** portable fan unit electric heater.
- e—Ceiling-mounted unit heater.
- f—**Wall-mounted** unit heater.
- g—Resistance-type boiler for steam or hot water.
- h—**Piping arrangement** for connecting an electric water heater to a fire-box coil.
- j—**Domestic** electrode-type hot-water heater for off-peak service.
- k—**Wiring diagram** for a unit heater.
- l—**Arrangement** of an electrode boiler.

# ELECTRICAL HEATING

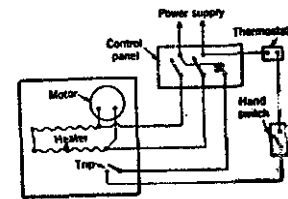
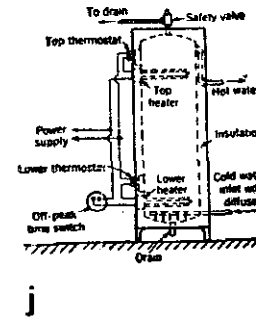
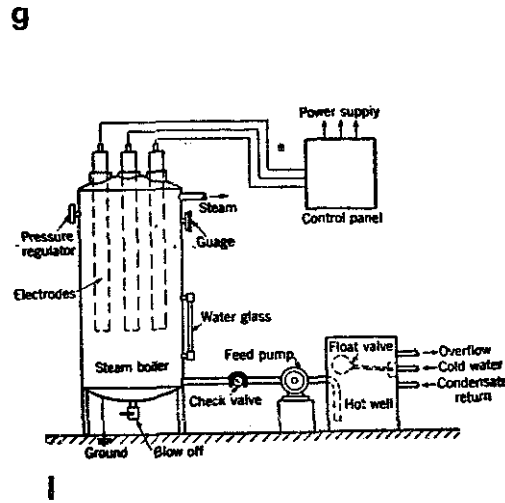
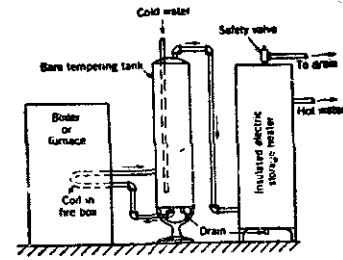
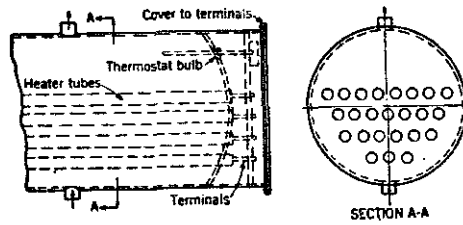
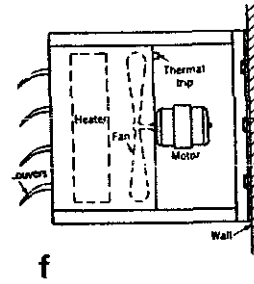
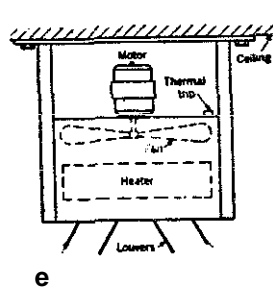
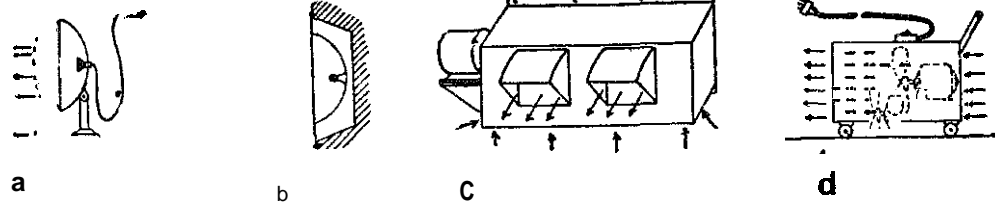

B—Electricity

6—RESISTANCE, INDUCTANCE AND CAPACITANCE. Resistance is the property of limiting the passage of electric current to a predictable level. Value of the resistor is expressed in ohms. Capacitance is the property of an electric non-conductor to store energy as a result of electric displacement, where opposite plates are held at different potentials. Inductance is the property of an electric component where electromotive force is induced into it by the circuit, or by a neighboring circuit.

a—**Electric current** compared to water flowing in a pipe; the pressure exerted on the water is analagous to the voltage; the quantity of water flowing is comparable to the current; the friction between water and the pipe is similar to the resistance.

b—**Cross section** of a piece of copper wire through which no electric current is flowing; electrons are assumed to be moving in all directions.

c—Orderly **parade of** electrons caused by connecting the ends of the wire to the terminals of a battery; the electrons are made to drift from atom to atom toward the wire connected to the positive battery terminal; this orderly parade of electrons is an electric current; the electrons travel from the negative terminal of the battery to the positive terminal, but current flow is considered as from positive to negative.

d—**Three resistances in series** with electric circuit symbol. Total resistance is the sum of the three resistances, or  $R_t = R_1 + R_2 + R_3$

e—**Three resistors in parallel.**

f—**Electric symbol showing three resistors in parallel.** The total resistance of this set-up is

$$\frac{1}{R_t} = \frac{1}{R_1} + \frac{1}{R_2} + \frac{1}{R_3}$$

g,h—**Relationship between the deflection** of a magnetic needle and the **direction** of current.

j—**Three capacitors in parallel.** Their total capacitance is the sum of the capacitances.

k—**Three capacitors in series.** Their capacitance can be calculated from

$$\frac{1}{C} = \frac{1}{C_1} + \frac{1}{C_2} + \frac{1}{C_3}$$

l—**Three inductance** coils in series. Their total inductance  $L_t = L_1 + L_2 + L_3$ , if they are far enough apart not to influence each other.

m—Section through an **electrolytic capacitor.**

# RESISTANCE, INDUCTANCE & CAPACITANCE

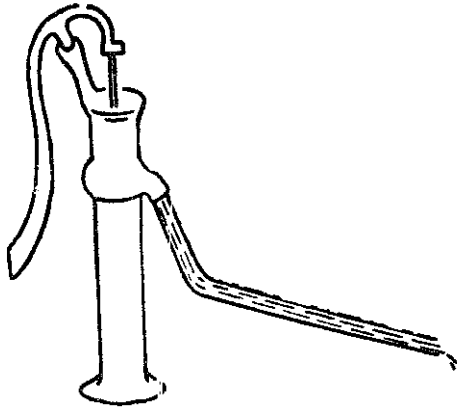

a



b

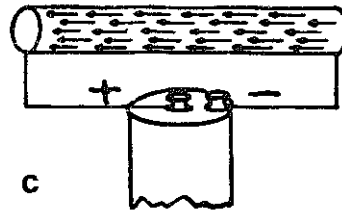

c

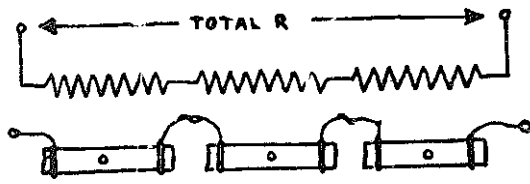

d

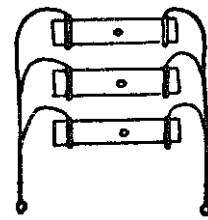

e

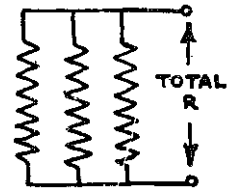

f

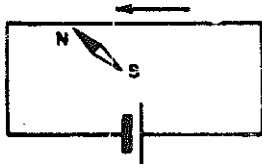

g

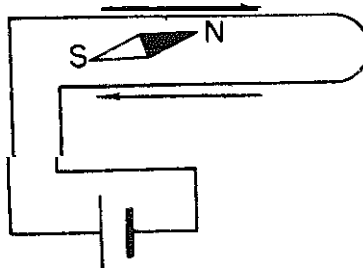

h

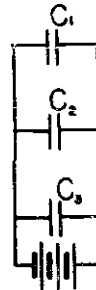

j

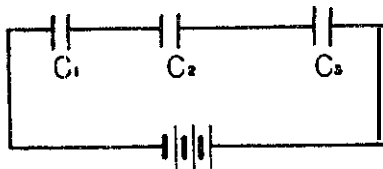

k

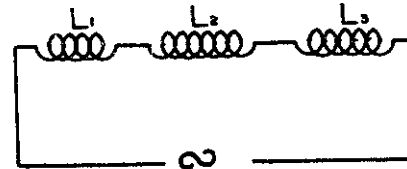

l

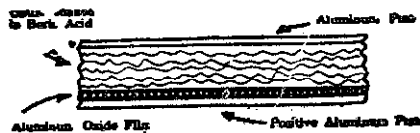

m



## B-Electricity

### 6-RESISTANCE, CAPACITANCE AND INDUCTANCE (Cont)

**n-Charging the capacitor.**  $V_{ab}$  is the voltage source. On closing switch S, the capacitor acts as a short circuit, and the current is controlled at that instant by the resistance only, and maximum current flows. The potential difference across the capacitor C increases until it reaches  $V_{ab}$ , and all current flow stops. 68% of the full voltage is reached within one time constant, or  $R \times C$  seconds (R in ohms, C in farads). Within four time constants the capacitor is practically fully charged.

**p-Charging curve** of capacitor. (q is the instantaneous charge).

**q-Discharge curve** for capacitor.

**r-Current through capacitor** during charging. As the voltage across the capacitor builds up, the current decreases.

**s-Constant potential** difference across coil L and a resistor.

t-When current is switched on, self-inductance of coil L acts as open circuit. Then current through it grows like curve shown. Note that it looks like charge curve of capacitor, which is proportional to voltage curve of capacitor.

**u-Decay of current** in circuit. Inductance tries to keep current going.

**v-Alternating current.** One cycle shown,  $360^\circ$  or  $2\pi$  radians.

**w-Series alternating current** circuit consisting of resistor, inductor and capacitor.  $X_C$  is the capacitive reactance,  $X_L$  the inductive reactance, Z the alternating current resistance called impedance,  $\phi$  the phase angle.

**x-Voltage-current** relationship in "w."

y-In a pure resistance, current and voltage are in phase. In a pure inductance the voltage leads the current by  $90^\circ$ . In a pure capacitance the current leads the voltage by  $90^\circ$ .

**z-Series resonant circuit.** At a frequency, determined by circuit parameters, the inductive reactance and capacitive reactance cancel. The total voltage of 100 volts appears across the resistor, and since  $V = I \times R$ ,  $I = \frac{V}{R} = \frac{100}{5} = 20$  amps. The  $+400$  Volts and  $-400$  Volts in quadrature cancel each other. In diagram "x" angle  $\phi$  would be zero, and Z would coincide with R.

**aa-Parallel circuit** with vector diagram. Note: Y is the admittance and equals  $\frac{1}{Z}$ ;  $g_1$  and  $g_2$  are called conductance, and are the real part of the admittance. The imaginary part of the admittance is called susceptance, here  $b_1$  and  $b_2$ .

# RESISTANCE, INDUCTANCE & CAPACITANCE

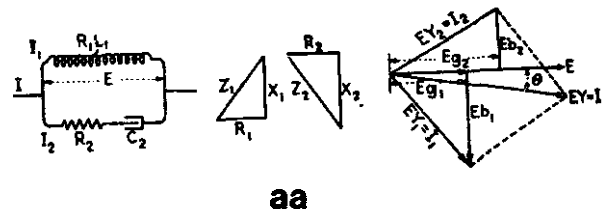
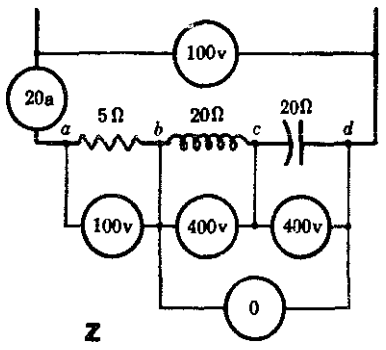
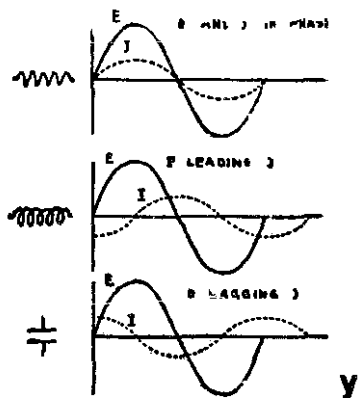
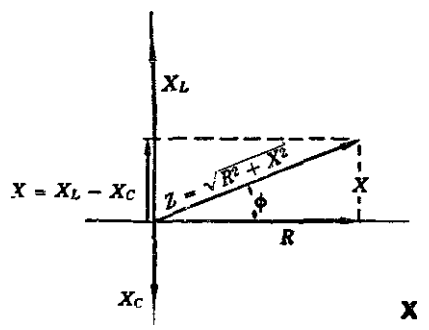
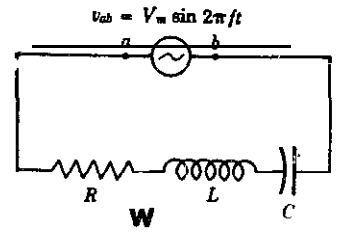
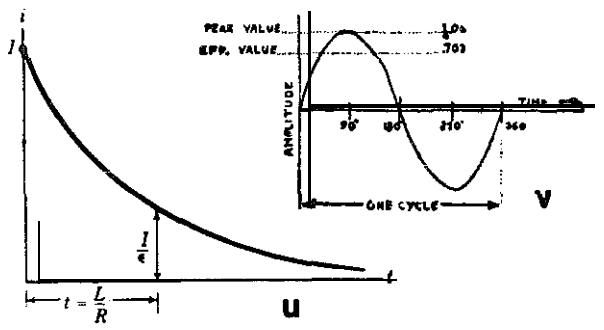
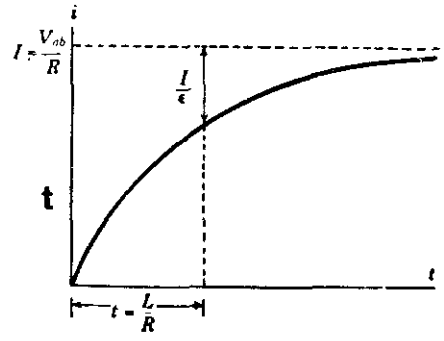
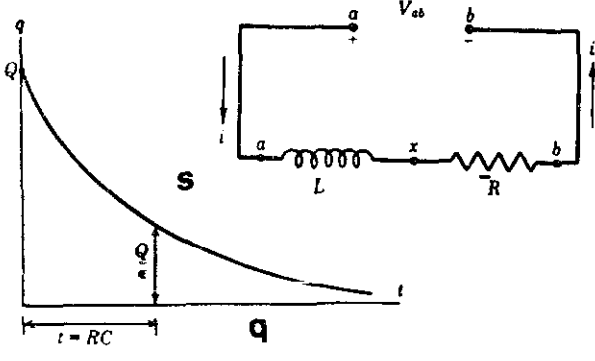
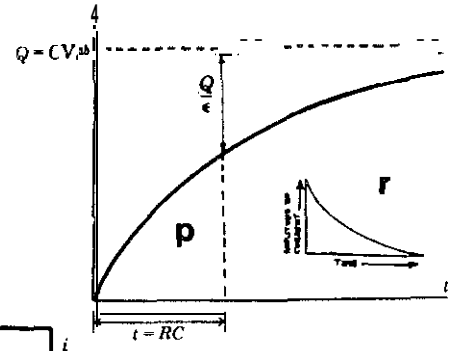
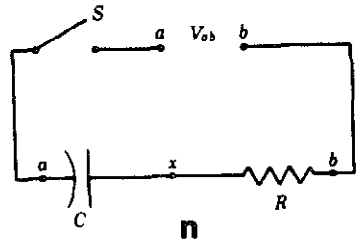

## B-Electricity

### 7-WAVE THEORY

a-Inductance and capacitance compared to a water system; when a surge of water from the pump strikes diaphragms Z, all of it cannot get through the small opening at the rate it comes from the pump and part of it is held back; this water then backs up into the storage spaces 1, 2, 3 when the surge stops, the flow through the diaphragm is maintained by the emptying of the storage spaces; the more storage spaces the steadier the flow; despite the fact that the pumping action itself is in surges.

**b-Hertzian oscillator;** it consists of two metal plates and a rod connecting them interrupted by a spark gap; a spark traversing the gap makes it a good conductor, so that the vibrator may be considered as a single piece of metal along which the charge oscillates.

c-Electromagnetic waves just leaving a **Hertzian** oscillator.

**d-Electric and magnetic field** around a dipole. Assume a capacitor and inductor in parallel and in resonance at a fairly high frequency. Separate the capacitor plates that they are at the top and at the bottom of "d." The magnetic field (solid lines) are perpendicular to the wire, while the electric field (dotted) is along the wire. Since configuration affects radiation efficiency, we have left only two wires (dipoles) and an alternator, in order to get high radiation efficiency. As the alternator reverses polarity, so do the associated fields around the **dipole**.

e-Radio waves travel as electromagnetic and electrostatic fields with the energy divided between the two; the electromagnetic lines of force and the electrostatic lines of force are at right angles to each other in a plane perpendicular to the direction of propagation; when a radio receiver picks up a radio wave, the wave induces a signal into the receiver at a value of possibly one millionth of a watt.

f-Receiving apparatus; when electromagnetic waves impinge on a conductor, such as the aerial **M**, they set up oscillations in that conductor which may be detected by various means; the simplest of these is the crystal detector **Z**; **T** is a telephone or telegraph.

**g-Crystal rectifying effect.** Crystal has low impedance for current flowing in one direction, and very high impedance for the following half-cycle when the current flows into the other direction.

WAVE THEORY

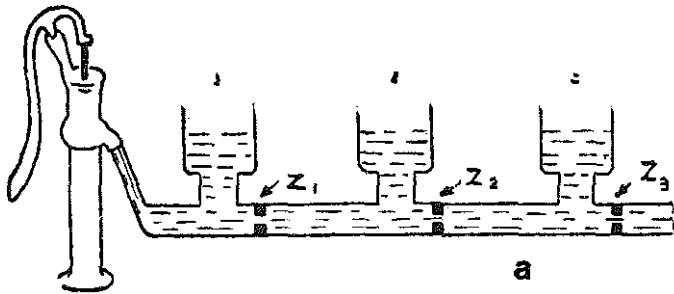

a

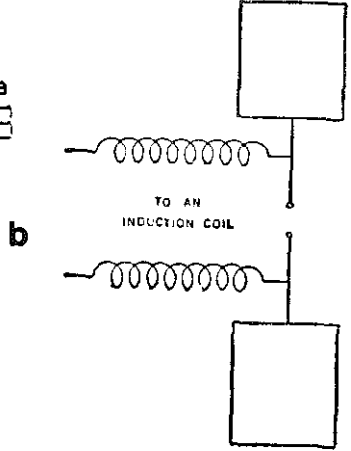

b

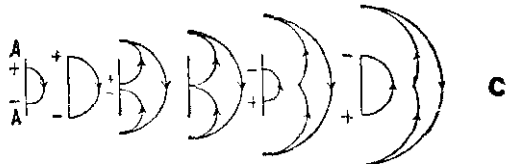

c

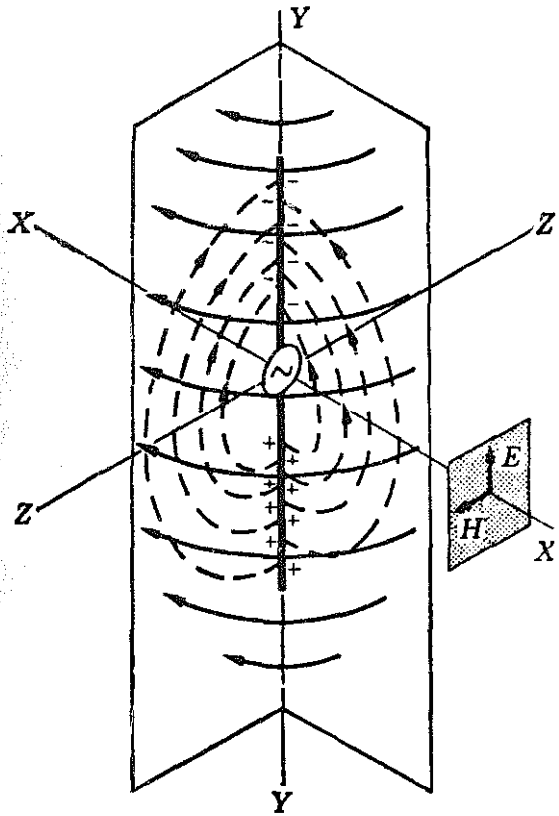

d

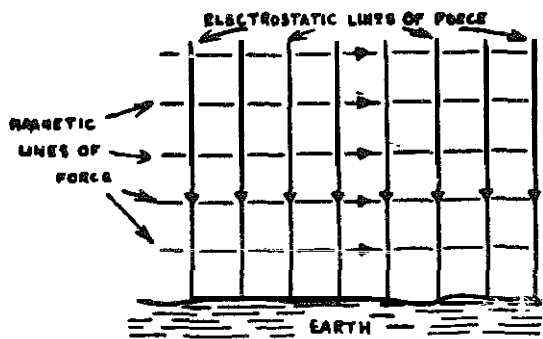

e

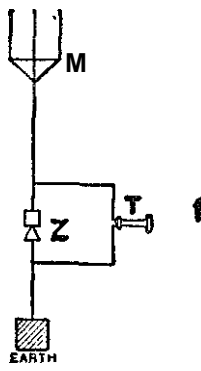

f

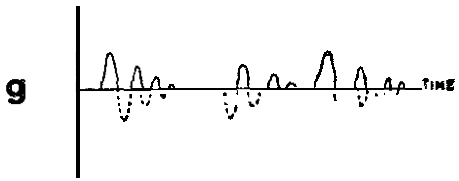

g

## B-Electricity

S-TRANSFORMERS-consists of two coils wound around the same core. An A.C. current in one coil induces an A.C. flux in the second coil producing an A.C. E.M.F.

**a-Step-down transformer.** The primary coil  $P$  consists of fine wire and the secondary coil  $S$  consists of heavy wire to induce a large alternating current of low voltage in  $S$  when a small current of high voltage passes through  $P$ .

**b-Transformers used** to transmit electric power over long distances.

**c-V-connections** for transforming moderate amounts of three-phase power.

**d-T-connection** for transforming moderate amounts of three-phase power.

**e-T-connection** for transforming from three-phase to two-phase power.

**f-T-connection** for transforming from three-phase to four-phase power.

Mutual flux

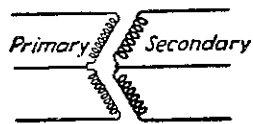
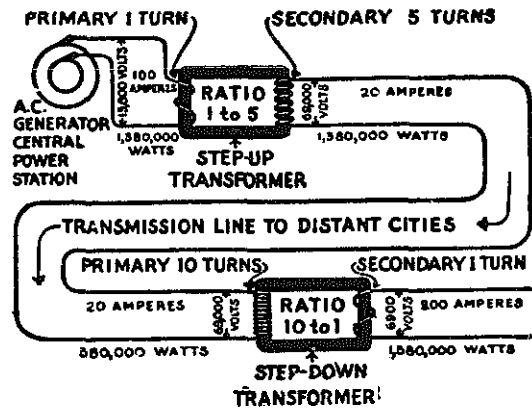
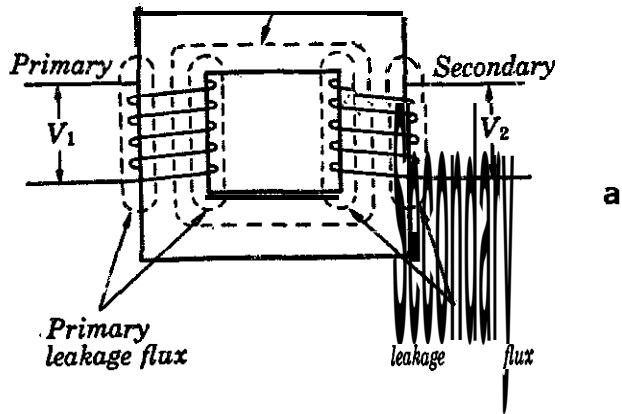

c

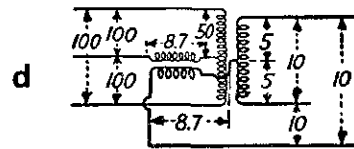

d

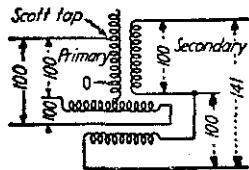

e

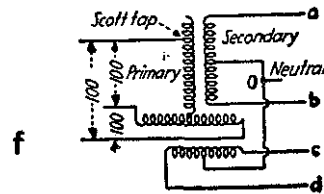

f

## C-Electrical Devices

### 1-MECHANICAL SWITCHES

**a—Single pole**, single throw toggle switch. Switch is shown in open position. To close the circuit, handle (2) has to be thrown to the right forcing spring (3) over the center, which makes link (4) touch stationary contact (1).

**b—Typical** snap-acting switch.

**c—Limit switch**, operated with small force. (The Automatic Electric Co.)

**d—Snap action** switch. The slotted one piece mainplate, prestressed by heat treating, is designed that the center member is compressed, and the outside members under tension. Pressing actuator makes contact snap to the opposite contact.

**e—Magnetic proximity** switch. Switch is usually fixed and the magnet attached to a moving part. As it passes by the hermetically sealed reed switch, the switch makes contact and releases as soon as the magnet moves away. Other motions of the magnet are possible. Only one set-up is shown. (Reed Switch Developments Co., Inc.)

**f—Definitions** for plunger positions of push button snap action switches. Pre-travel, over-travel, differential travel.

**g—Miniature rotary** selector switch. Indexing in  $30^\circ$  steps, 12 positions, up to 6 poles per section. (Electro Switch Corp.)

**h—Rotary** stepping.; switch. Indirectly driven; steps when the coil is de-energized. (The Automatic Electric Co.)

MECHANICAL SWITCHES

MOVEMENT CHARACTERISTICS

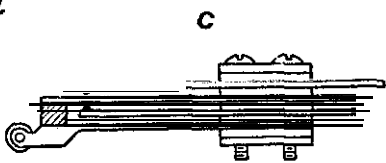
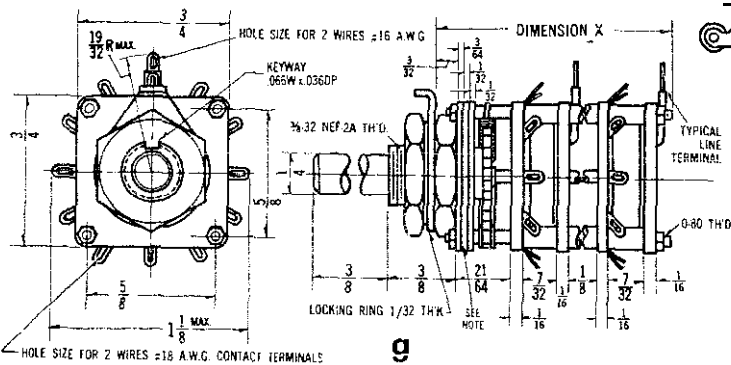
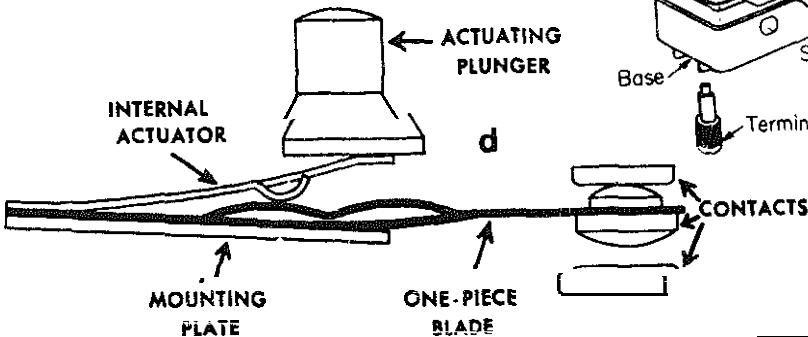
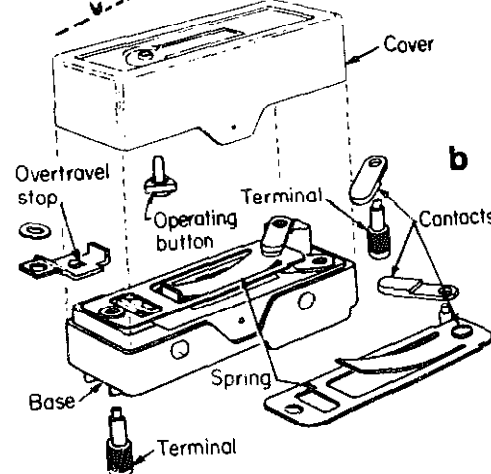
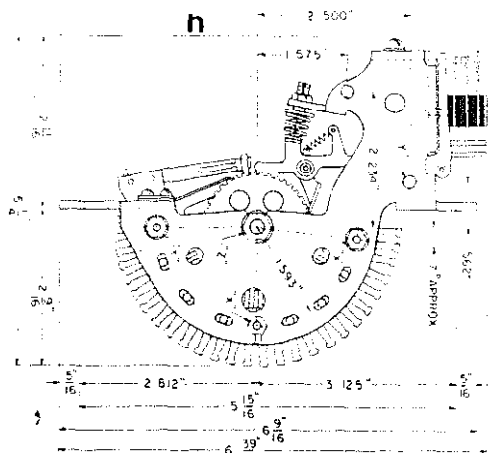
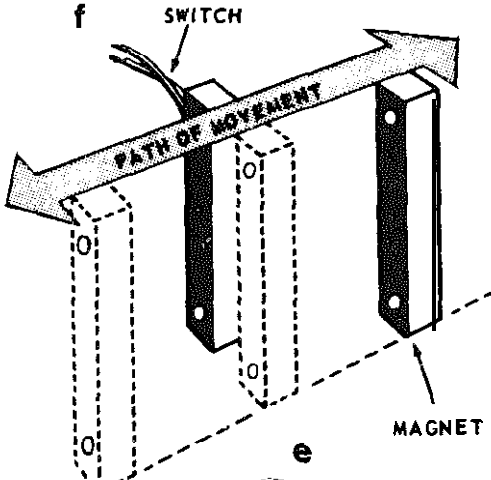
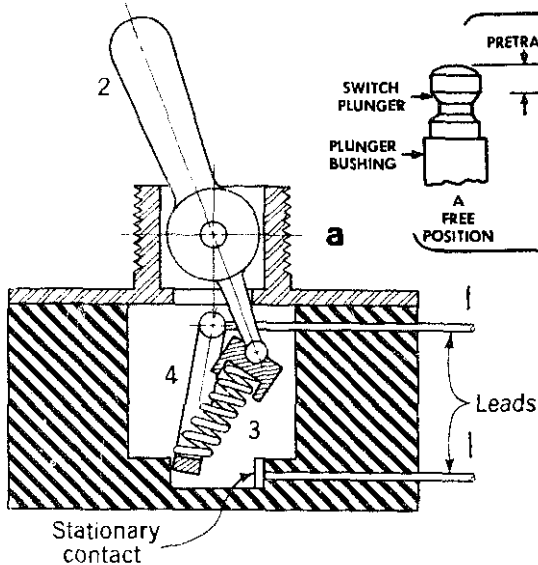
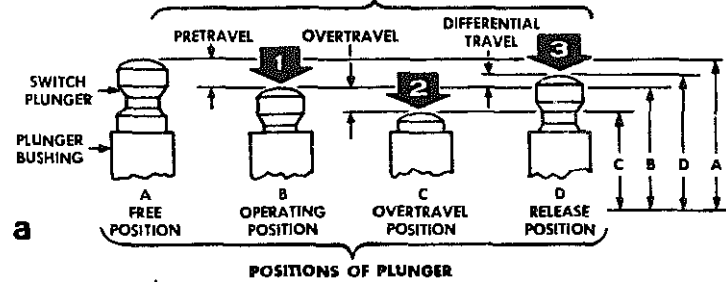



## C—Electrical Devices

2—**MERCURY SWITCHES**. A mercury switch consists of a hermetically sealed glass housing with two or more electrodes and a pool of mercury. If the pool contacts two or more electrodes, contact is made and the switch is in on position.

a—**Single pole single throw mercury switch**.

b—**Single pole, double throw mercury switch**.

c—**Diagram** illustrating the use of a three contact, single pole single throw switch.

d—**Mercury switch** arrangement for delayed action.

e—**Mercury switch**, acceleration type. The contacts will close if object to which switch is attached reaches predetermined acceleration in the direction of the arrow

f—**Double pole, double throw switch**, can establish two circuits by tilting to the right or to the left

g—**Mercury switch** for indicating motion in one direction. Contacts are closed once during each revolution in direction shown, but not if unit turns into the opposite direction.

h—**Mercury switch** operated by a relay.

j—**Magnetically** operated nontilting switch; a light iron rod bridges the mercury pools; an external electromagnet raises this rod to open the circuit.

k—**Switch for** indicating movement in a certain direction; tilting the switch toward the right closes the contacts, which remain closed until the switch is subsequently tilted in the opposite direction.

l—**Actuation of mercury switch** by means of bimetallic strip.

m—**Actuation of mercury switch** by electromagnet with time delay.

n,p—**Centrifugal switches** designed for rotation about a vertical axis; “n” opens the contacts; “p” closes the contacts, when the speed of rotation exceeds a given rate, by forcing the mercury upward in the bulb.

q—**Inclination switch**; the normally open contacts are completed if the vertical axis of the tube is inclined about 30° in any vertical plane.

r,s,t—**Mercury switches** with delayed action.

u,v—**Vertical type, coil operated contacts**.

w,x—**Reverse acting, vertical type coil operated contacts**.

# MERCURY SWITCHES

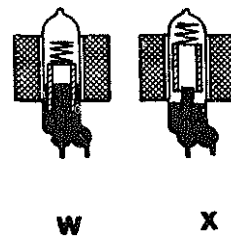
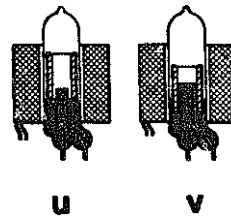
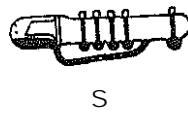
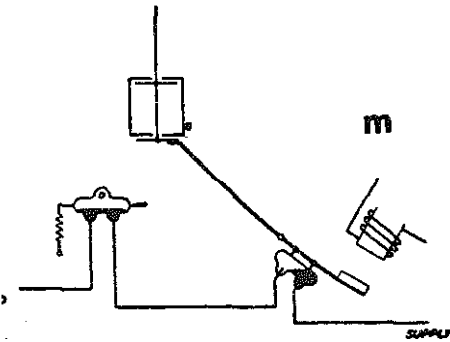
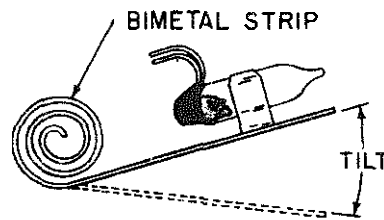
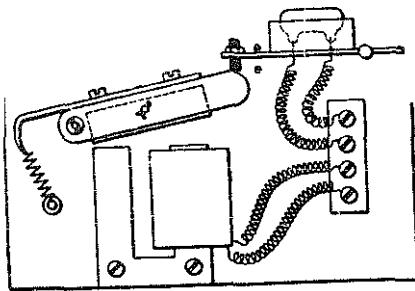
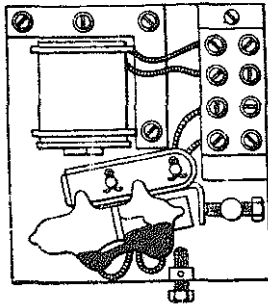
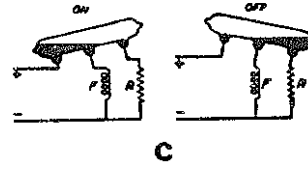
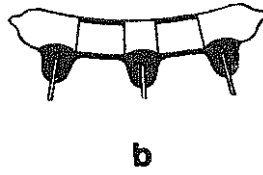
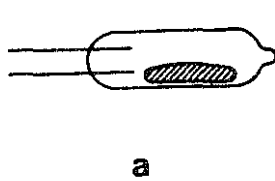

## C--Electrical Devices

### 3--MISCELLANEOUS SWITCHES

a-Coordinate-acting electromagnetic crossbar switch. Operation: 1-select system operates first, pulling interposers on select tube toward actuator, 2-Hold **system** pulls hold bar toward hold magnet, taking with it any operated interposer, and interposer hits rocker. 3--rocker lowers pusher, which closes the contact pairs below it. (James Cunningham, Son & Co., Inc)

**b--Rotary magnetic reed switch.** Rotary arm carries a magnet, and arm detents over each reed switch.

c-Depression of **button** moves magnet, and magnet closes the close-by reed switch. (Hari-Advance Relay Div.)

**d--"Snap-Reed" slide switch,** uses coil spring snap action to position magnet for actuation of a reed switch. (Cherry Electrical Products)

e-One possible design of a **reed switch.**

**f--Limit switch** in proper position for two-way overriding beam.

**g--Thermally operated vacuum switch.**

h-Burgess vacuum contact switch; a magnet 8 attracts an armature attached to a lever 9 and pulls it down against the tension of a spring 11, so that the switch contacts are in the position shown; when the current in coil 8 is cut off, the spring 11 pulls the lever 9 upward, and its pressure on a sleeve 2 opens the contacts 3 and 5; the reverse operation may be obtained by arranging the armature on the opposite side of the sleeve 2, so that excitation of the coil 8 will cause pressure of the arm 9 on the sleeve to open the contacts 3 and 5; although the spark at the opening of contacts is very small, the heat may be sufficient to cause a slight volatilization, and the spark may not be visible in this type of switch; the pressure necessary for positive operation is small, so that it **will work** easily with the mechanical movement of a standard telephone relay; the path of the extremity of the stem is about 0.02 inch long and the elasticity of the glass permits repeated movements many times a second.

10

# MISCELLANEOUS SWITCHES

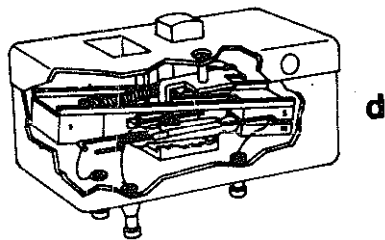
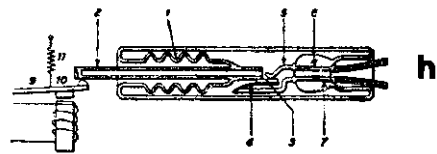
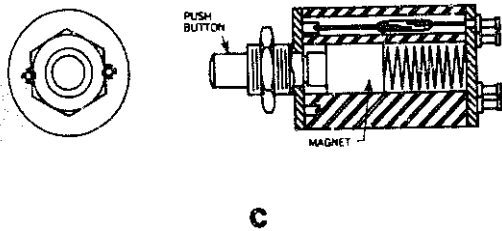
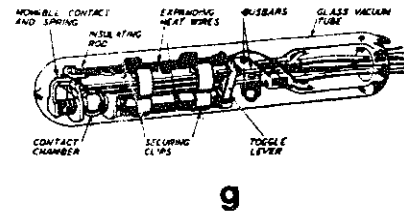
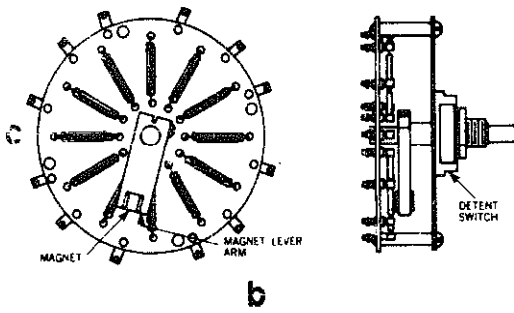
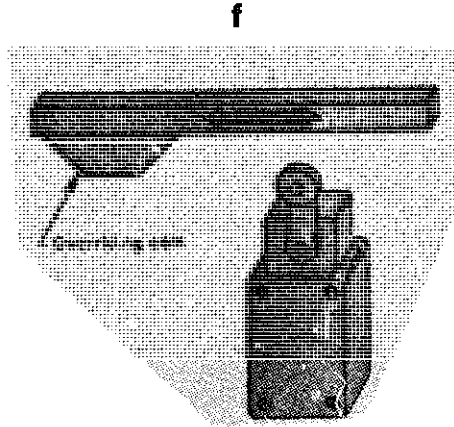
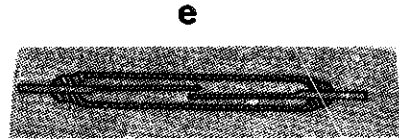
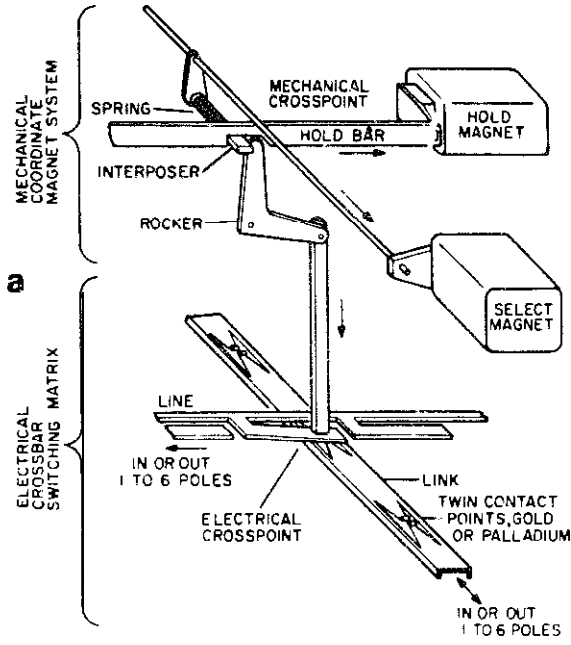

C—Electrical Devices

4-BELAYS AND SOLENOIDS. In electromagnetic relays the current through its coils forms a magnetic field attracting an actuator which in turn makes and breaks contacts. A solenoid is usually a coil of wire with a movable core that pulls in when the coil is energized, thereby imparting motion to an object connected to it.

**a—Typical relay**, showing contacts, the coil with leads and mounting location for screw. Called a clapper-style relay.

**b-u—Symbols** for relay contacts. “b,” make or SPSTNO (single pole, single throw, normally open); “c,” break or SPSTNC (normally closed); “d,” break make or SPDT (B-M) (single pole, double throw, break-make); “e” same as “d”; “f,” break-make-break or SPDT(B-M-B); “g,” make, make or SPST(M-M); “h,” break, break or SPST(B-B); “j,” break, make, break or SPST(B-B-M); “k,” make, break, make (M-B-M); “l,” make, make, break or SPST(M-M-B); “m,” single pole, double throw, center off or SPDTNO; “n,” break, make, make, or SPST(B-M-M); “p,” double make, contact on arm or SPSTNODM; “q,” double break, contact on arm or SPSTNCDB; “r,” double break, double make, contact on arm or STDTNC-NO(DB-DM); “s,” double make or SPSTNODM; “t,” double break or SPSTNCDB; “u,” double break, double make or SPDTNC-NO(DB-DM).

**v—Siemens high speed** relay.

**w—Slow-operating** relay with copper slug at the armature end of the coil; the broken arrow indicates the path of the magnetic flux due to the main coil at the instant of closing the coil circuit.

**x—Slow-releasing relay** with a heel slug at the end of the yoke which is remote from the armature; the operation of this relay is not affected when the coil circuit is made but a delayed release is secured when the circuit is opened.

**y—Polarized relay**; the armature 2 makes contact either on the left or on the right, according to the direction of the current through the field coil.

**z—Mercury-wetted** contact switch, known better as reed relay. Base of reed is in a mercury pool. Contact side can move between stationary contacts. Mercury flows up the reed through capillary action, wetting contact surface.

**aa,ab—Two methods of arc suppression.**

**ac—Latching relay.** If relay is energized, armature is pulled up, and is mechanically latched until released.

**ad—Stepping relay.** This is a direct driven type. When the relay is energized it pulls in the armature. The pawl attached to the armature advances arm of bank assembly and a new set of contacts is connected.

**ae—Typical solenoid.**

# RELAYS & SOLENOIDS

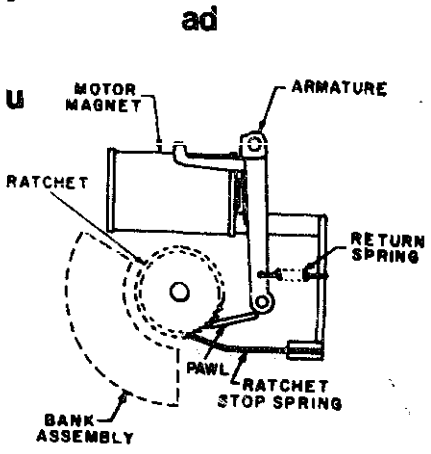
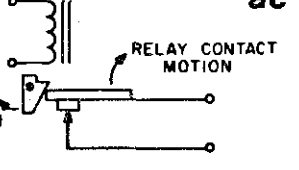
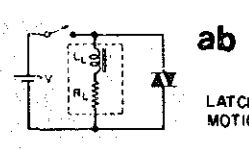
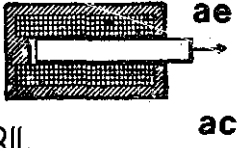
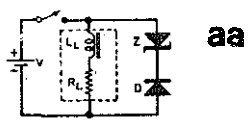
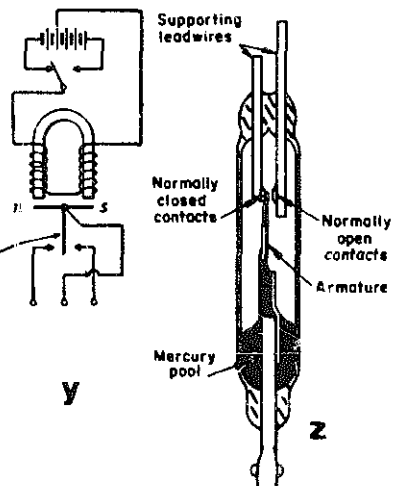
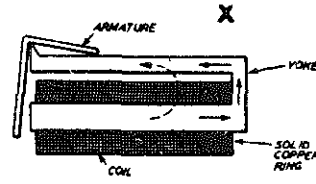
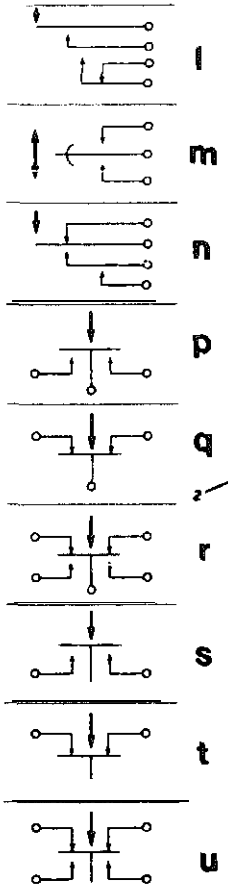
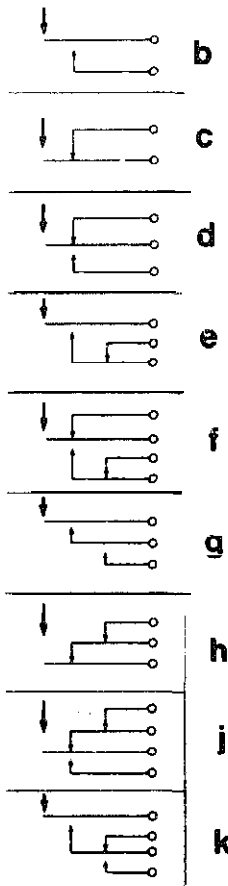
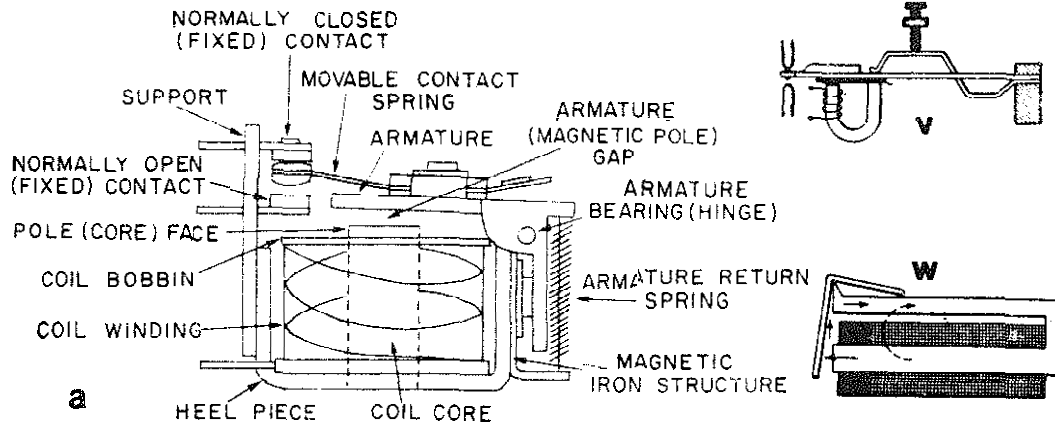

## C-Electrical Devices

### 5-MEASURING INSTRUMENTS

**a-Voltmeter**; used for measuring the difference of potential or electromotive force between two points in an electric circuit;  $r$  is a high-resistance coil.

**b-D'Arsonval galvanometer**; used to detect the presence of an electric current, its direction and strength.

**c-Ammeter**; used for measuring the strength of a current in amperes;  $t$  is a shunt; other ranges are available like milliamperes and microamperes.

**d-Kelvin multicellular** electrostatic voltmeter.

**e-Leeds and Northrup reflecting galvanometer**; its sensitivity permits detection of a current as weak as 0.2001 microamperes.

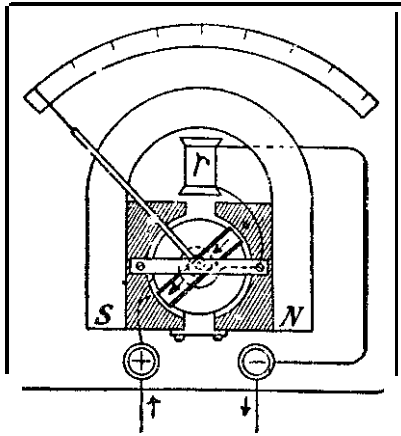

a

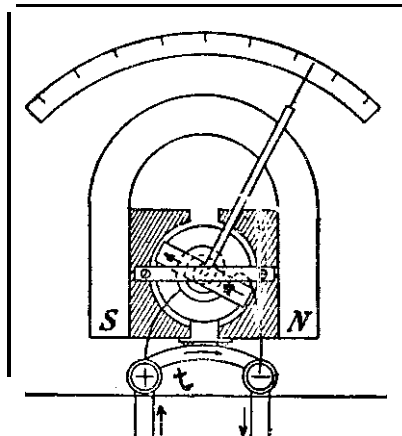

c

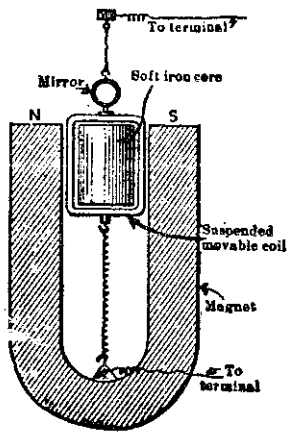

b

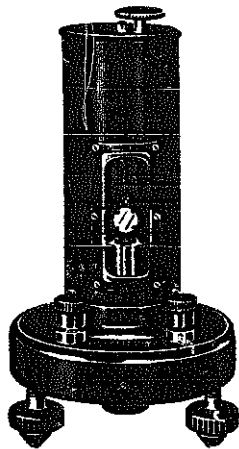

e

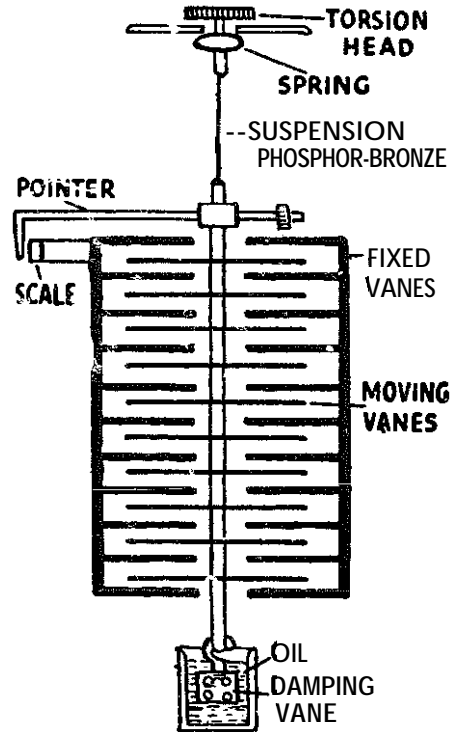

d



C—Electrical Devices

5—MEASURING INSTRUMENTS (Cont)

**f—Small voltaic cell and coil floating in a dish of water;** when the north pole of a bar magnet is brought near the coil, the circuit will always rotate so as to present that face in which the current is flowing clockwise; i.e., the south face of the coil is attracted by the north pole of the magnet; also the coil will move so as to include more lines of force; this illustrates Maxwell's rule.

**g—Tangent galvanometer** (W. M. Welch Mfg. Co.)

**h, j—Moving indicators;** "h" shows gravity control; "j" illustrates spring control: the moving systems on the indicators are suspended or pivoted in jewelled bearings which can be twisted through an arc of 90° to 270°; the magnetic, thermal, or electrostatic effect is made to exert a torque; the angle of deflection is indicated by a pointer attached to the moving system or by a light spot reflected from a mirror, and is a measure of the current or voltage.

**k—Piston damper;** prevents undue oscillations of an indicator.

**l—Vane damper.**

**m—Moving-coil permanent-magnet system.**

**n—Attraction-type moving iron instrument.**

**p—Repulsion-type moving iron instrument.**

**q—Galvanoscope;** the current-carrying part of the wire is movable and the magnet is fixed.

**r—Thermo-galvanometer;** adapted to measure a small alternating current which changes direction so rapidly that it does not affect the coil of a galvanometer; the amount of heat depends on the square of the current and the heating effect is independent of the direction of the current; the heating effect offers a method of measuring alternating currents; antimony and bismuth form the thermocouple.

**s—Thermocouple instrument;** when the junction of two dissimilar metals is subjected to different temperatures, an electrical potential is set up between them which is proportional to the temperature difference; if a moving-coil ammeter is placed in the circuit, it will measure the current flowing when the temperature of one junction is raised by heating.

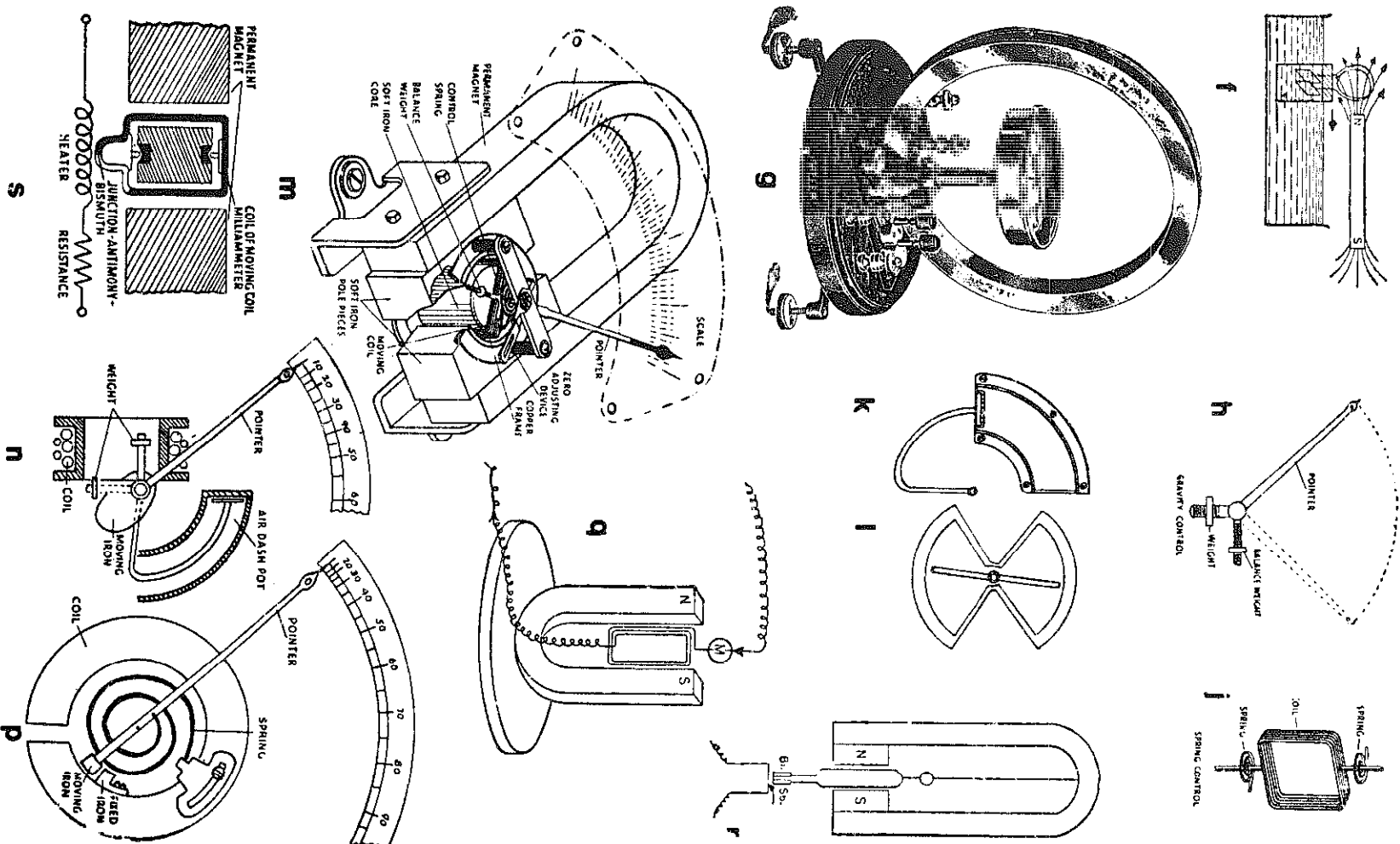

## C-Electrical Devices

### S-MEASURING INSTRUMENTS (Contj)

**t**—**Weston direct-current** movable-coil system.

**u**—**Standard dynamometer-type** wattmeter in which the permanent magnet with moving coil is replaced by two fixed coils which provide an almost uniform field; used for measuring power.

**v**—**Hot-wire instrument** for measuring alternating currents exclusively; it depends on the expansion of a wire which is heated by the current or part of the current to be measured; used principally in radio work where high-frequency currents are to be measured.

**w**—**Induction instrument**; used in alternating circuits, on frequencies for which they are designed, to measure current and voltage.

**x**—**Shaded-pole induction** instrument for measuring current and voltage.

**y**—**Induction wattmeter for** measuring power in alternating circuits.

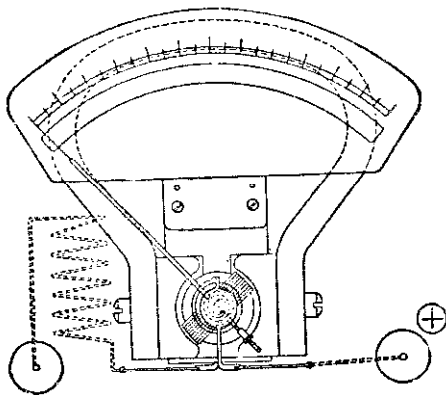

t

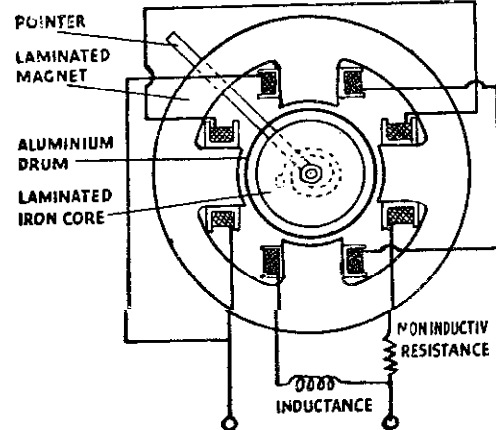
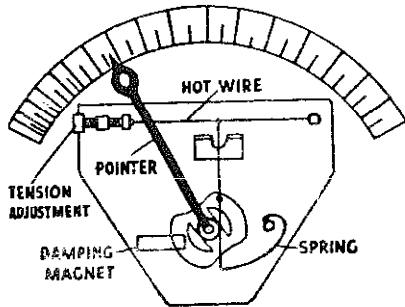

w

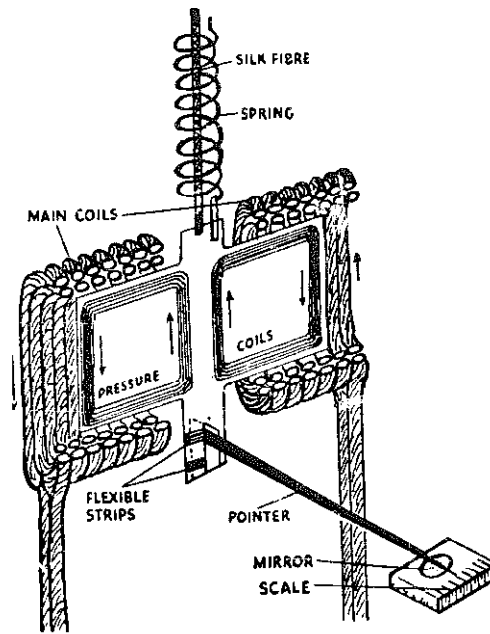

u

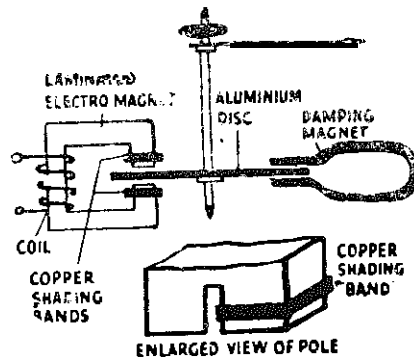

x

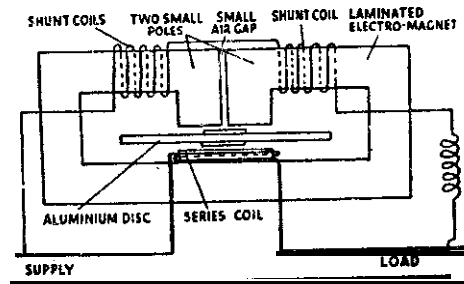

y

—Electrical Devices

5—MEASURING INSTRUMENTS (Cont)

**z**—A taut band meter. Usually used for full scale readings of a few microamperes. (Assembly Products)

**aa**—Meter relay with pushbutton reset. Basically contact is mounted on the instrument pointer, and when contact is made other circuits are closed. (Assembly Products)

**ab**—Large scale vacuum tube voltmeter (VTVM) with 29 ranges. (Triplet Electrical Instrument)

**ac**—Typical meter-relay, exploded view.

**ad**—Analogue servo type digital voltmeter.

# MEASURING INSTRUMENTS

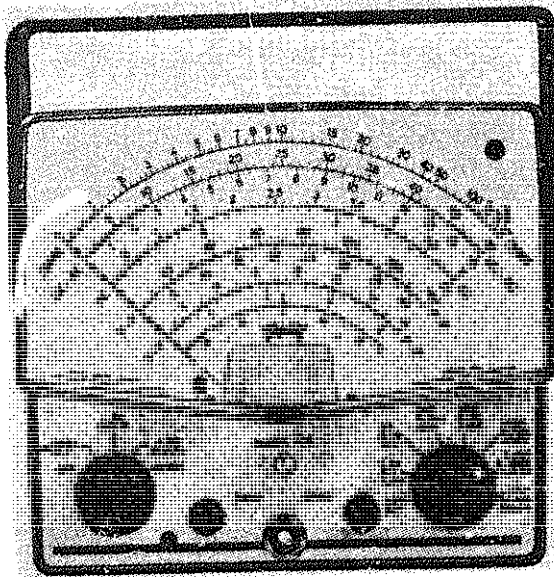
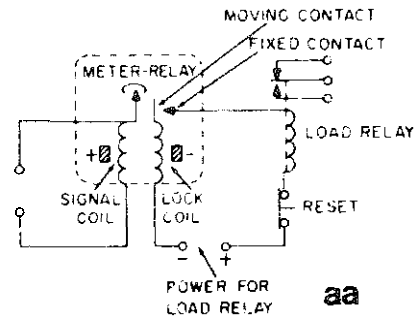
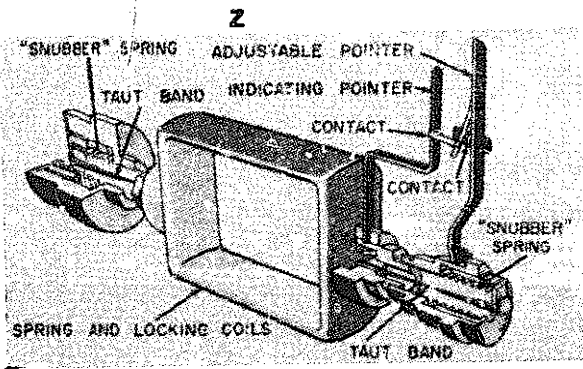

**ab**

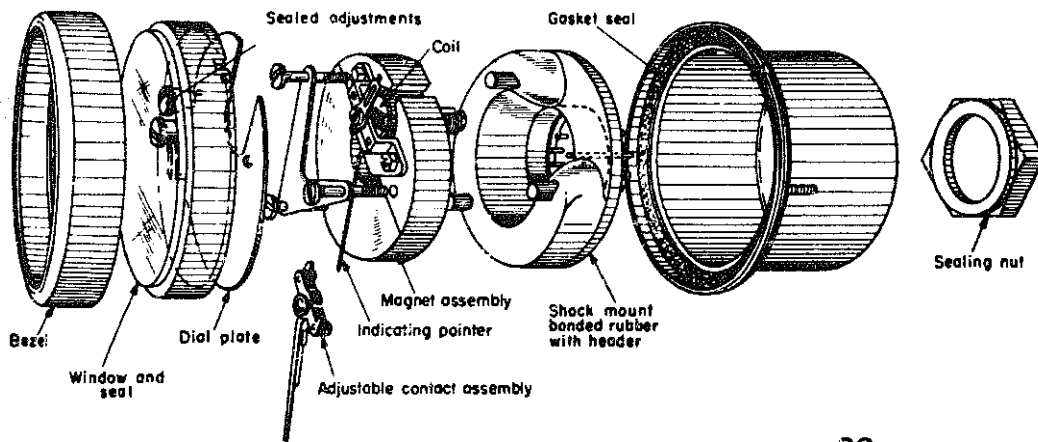
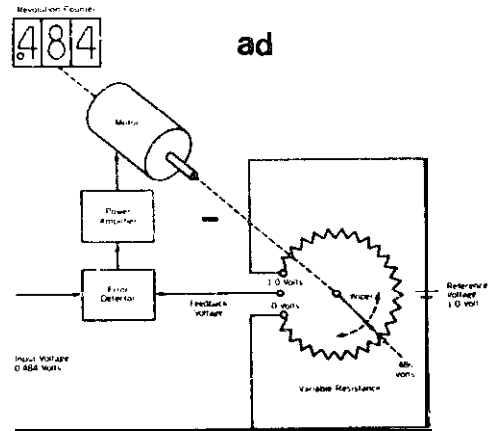

**ac**

## C-Electrical Devices

### 6-PRINCIPLES OF THE TELEPHONE

**a-Simple**, one-way telephone system; essential parts are a transmitter, a receiver, an induction coil, and an electric battery.

**b-Basic transmitter**; sound waves striking the flexible diaphragm push it in, which increases the pressure on the carbon granules thus reducing the electrical resistance; a refraction of the sound waves releases the diaphragm, decreases the pressure on the carbon, and increases the electrical resistance; the varying resistance causes continual fluctuations of current, which, acting on an induction coil, causes the diaphragm of receiver to vibrate in accordance with the vibrations of the transmitter.

**c-Circuit at the receiving end**, simplified.

**d-Basic telephone receiver**.

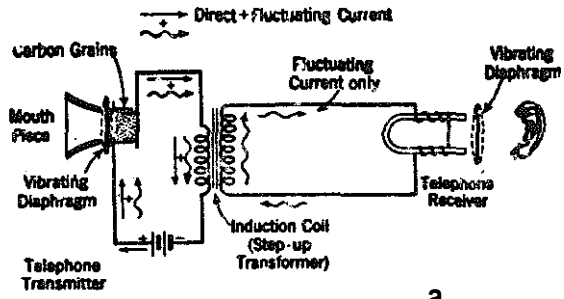

a

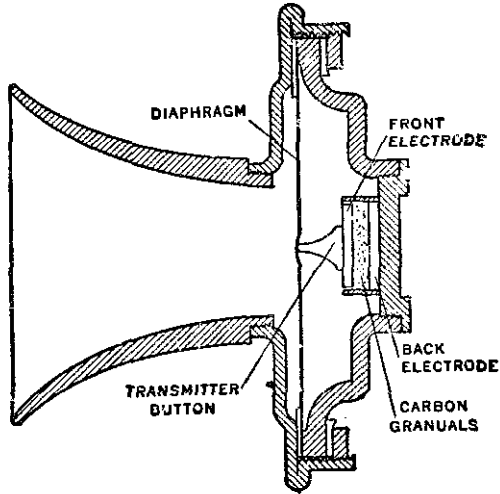

b

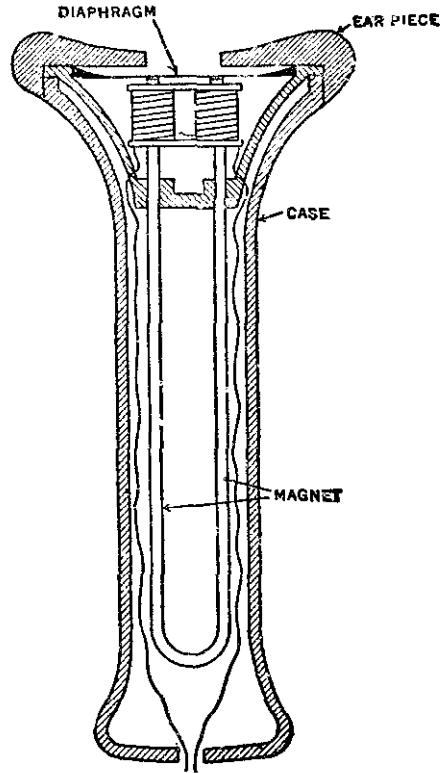

d

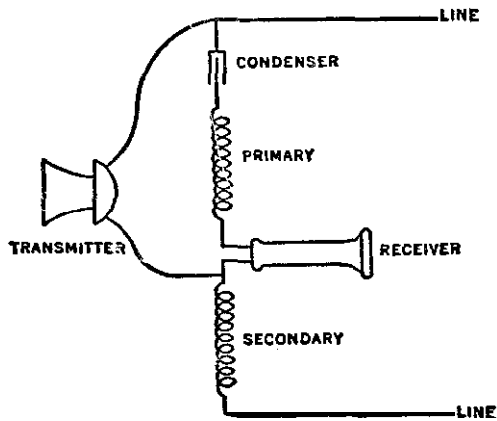

c



## C—Electrical Devices

7—SERVOMECHANISMS. Only the position servo will be explained. A servomechanism positions an object with respect to an input, and the operation depends on the difference of the position of the object and the desired position. A motor in this set-up tries to reduce this difference to zero. Servomechanisms belong to the feedback control system group.

a—**Block diagram** of a simple position servo. The parts comprising the system are shown, as well as the flow path. The input command is given to a potentiometer. Depending on the position of the arm of this potentiometer a given reference voltage will result, shown as “ $r$ .” The second potentiometer also has an output. The difference between these two voltages is an error voltage, “ $e$ ,” unless  $(r - b)$  is zero, then error voltage “ $e$ ” goes into the amplifier. The amplifier amplifies this voltage by driving the motor. The motor, through its gearing drives the second (feedback) potentiometer in a direction to make the error signal “ $e$ ” zero.

b—A **mixed schematic diagram** of the block diagram. Input to command potentiometer is a handcrank, as used in school experiments. Normally it will come from some other gear train.

c—**Electric schematic diagram** for the above unit.

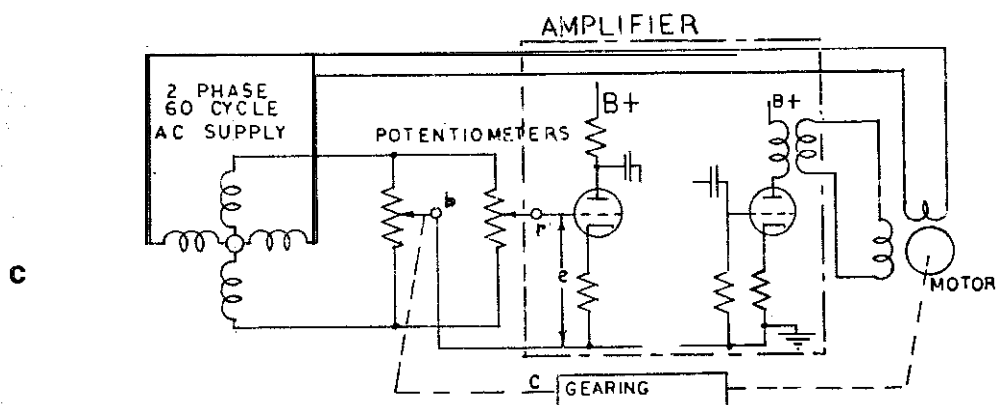
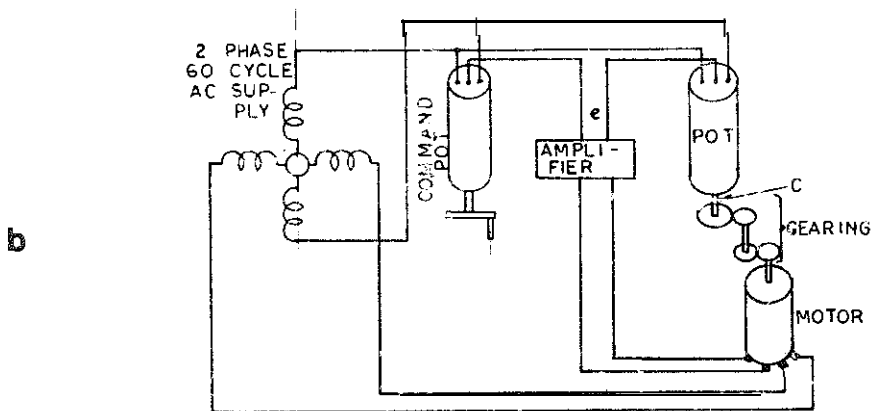
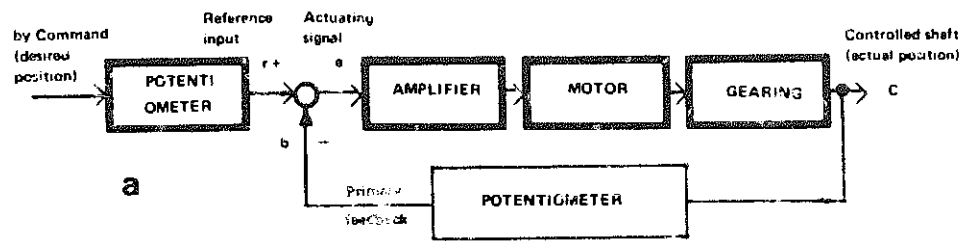

### C—Electrical Devices

**8—SYNCHROS AND RESOLVER:** Synchros are rotating components used to transmit angular data electrically from one place to another with great precision. It can be used for remote pointer indication, computation and remote control of servos.

**a—Remote Pointer System**—The transmitter rotor induces voltage across its three lines defining its position. As a consequence the receiver (indicator) aligns itself with this position.

**b—Synchro Transmitter**—Note the motor-like construction of the synchro. The rotor position is identifiable from the three stator voltages.

**c—Servomotor**—Motor used in control systems, energized from two phase supply. The main voltage an A.C. one, and the second a control voltage at 90° to the first, varied to perform the required task.

# SYNCHROS & RESOLVER

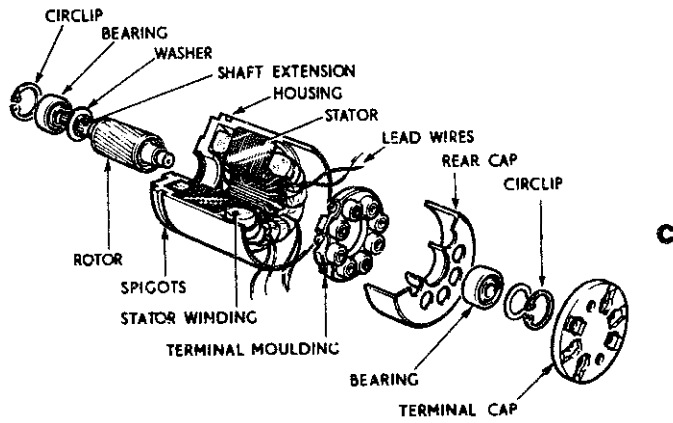
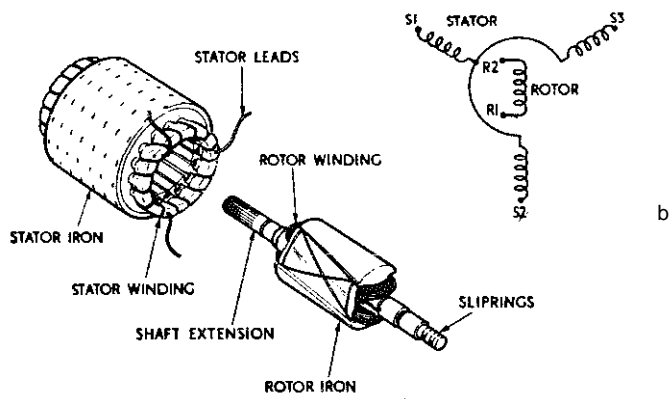
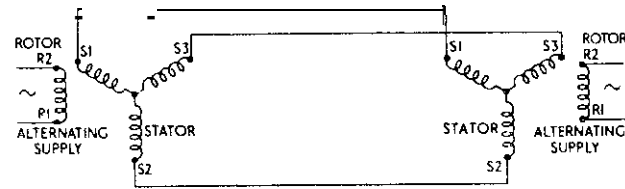
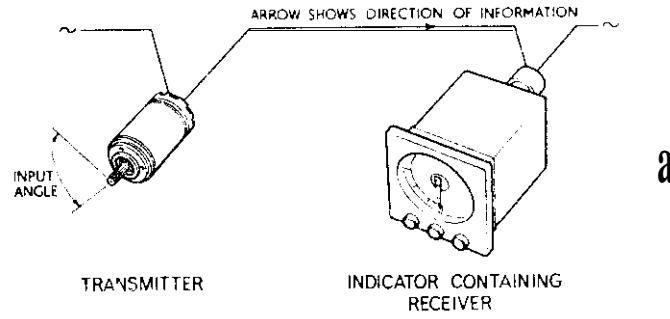

## C-Electrical Devices

### 8-SYNCHROS AND RESOLVER (Cont)

**d-Gyro System**-When more accuracy is required in a high load system, the addition of a control transformer and servomotor is desirable. In this arrangement the quantity being controlled is compared with the input. Any deviation is detected, amplified, and used to operate a motor that reduces the error to zero.

**e-Resolver**-A special form of synchro is called a resolver. It develops voltages proportional to the sine and cosine of the rotor angle. It therefore can be used for computation purposes or data conversion.

**f-Radar Display**-Use of resolver to provide an angular display of antenna position on a CRT display.

# SYNCHROS & RESOLVER

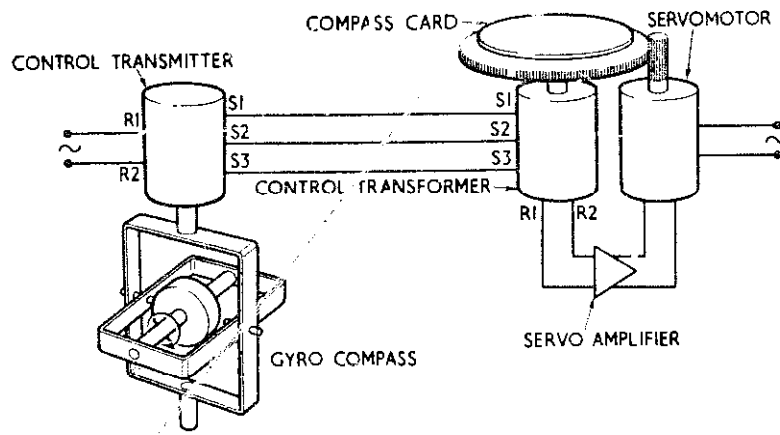

d

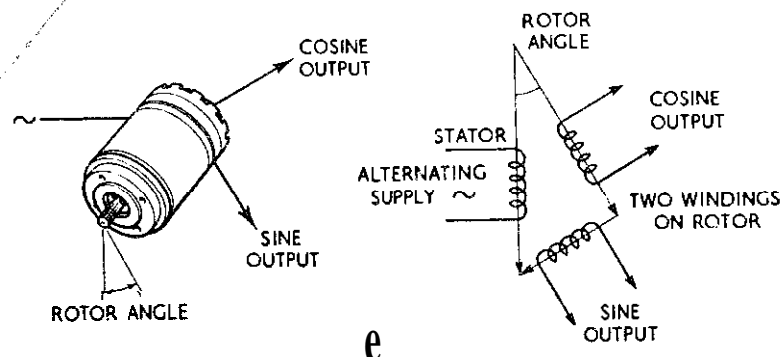

e

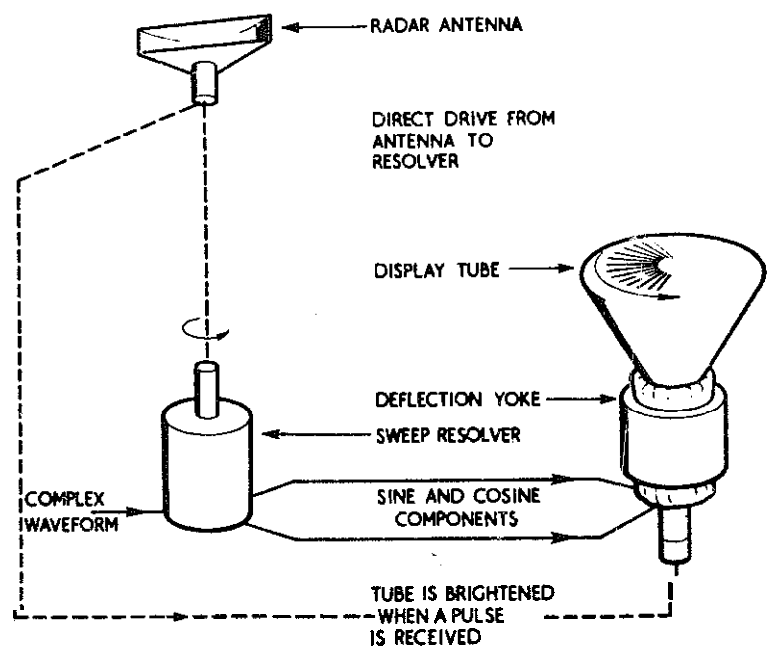

f

## D—Electronic Devices

I-VACUUM TUBES. All materials have electrons not rigidly bound to the atom, which are called free electrons. Conductors have a large number of these, non-conductors relatively few. It is possible, by various means, to increase this energy to a point, where the electrons can pass through a potential barrier into space. Heat is one of these means.

**a—Diode or two-electrode tube;** the first tube used in radio, having a filament and a plate; one battery is connected across the filament for heating purposes; the positive pole of another battery is connected to the plate.

b-No positive voltage on the plate of the diode because the switch is not closed.

**c—Electrons** are driven out of the filament by heat; called thermionic emission; the filament which emits electrons is called the cathode; the body or plate to which the electrons are attracted is called the anode; as soon as the switch is closed and a small positive potential on the plate is applied, a steady stream of electrons will be attracted from the filament to the plate, causing a current flow around the circuit.

**d—A stronger potential** causes more electrons to flow until the plate is saturated. If the plate potential is reversed, no electrons will be attracted and no current will flow; if an alternating current is applied to the plate, the plate is alternately positive and negative; the plate current only flows while the plate is positive; therefore, current through the tube flows in one direction only and is said to be rectified.

e-Connection of a **diode** with a directly heated cathode.

f-Circuit for **measuring the anode** characteristic of an indirectly heated diode. In the indirectly heated cathode, an oxide coated cylinder is heated by a wire carrying the heater current through the inside of this cylinder.

**g—Typical anode current-anode** voltage characteristics; all thermionic vacuum tubes have anode characteristics of similar shape.

# VACUUM TUBES

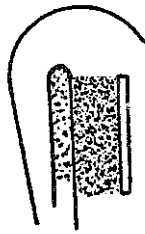
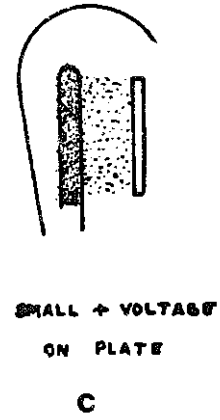
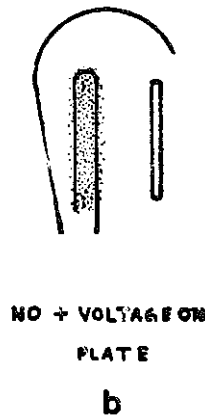
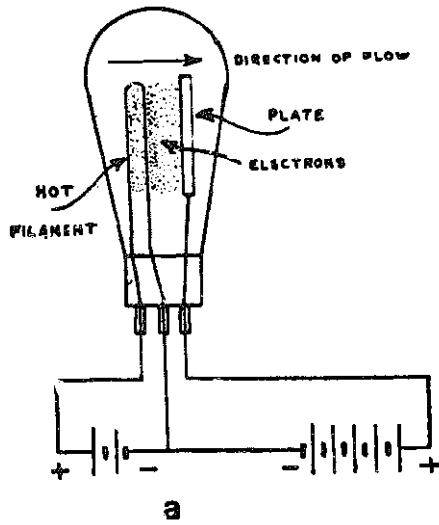

LARGE + VOLTAGE  
ON PLATE

d

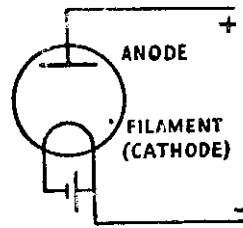

e

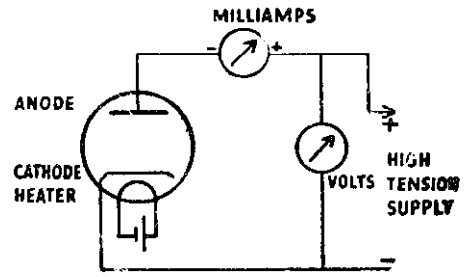

f

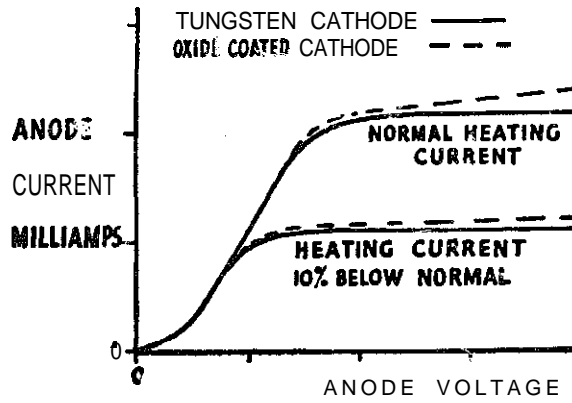

g



D-Electronic Devices

1--VACUUM TUBES (Cont)

h-Symbols: Filament F (or heater) and envelope.

j-Symbol: **cathode K** added.

k-Symbol: grid **G** added. Grids are shown either as broken lines or zigzag lines.

l-Symbol: Plate P added. Now we have a complete symbol for a triode.

m-Symbol: Screen grid **SG** added.

n-Symbol: **Multigrid** tube. The grids are numbered successively from the cathode toward the plate. This tube is a **1C7-G** pentagrid converter.

p-Symbol: **heater-type** diode; two plates **DP<sub>1</sub>** and **DP<sub>2</sub>** and a common cathode K.

q-Symbol: **triode** elements added to "p" to form duodiode triode.

r-Base connections under view, indicating element connections to the base; the pins are numbered clockwise, starting at the locating key on octal tubes.

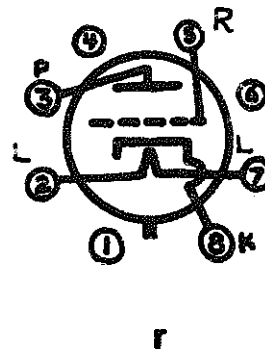
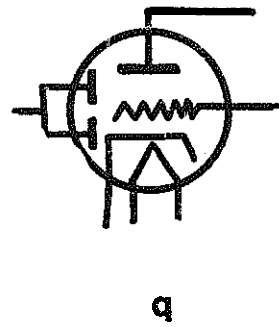
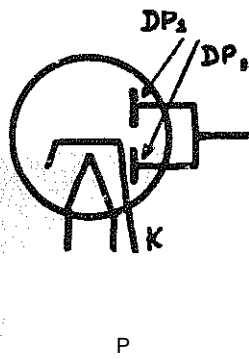
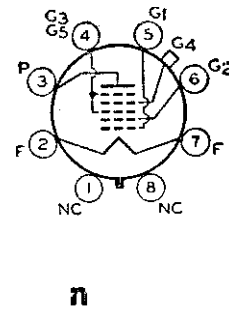
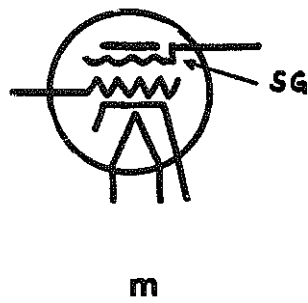
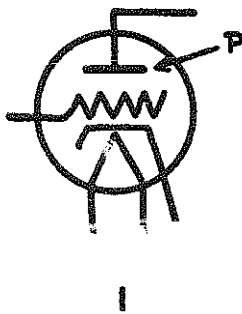
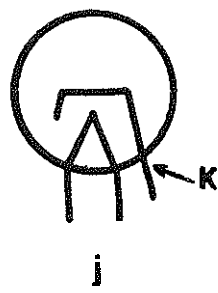
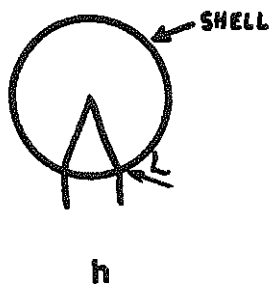

## D-Electronic Devices

### 1-VACUUM TUBES (Cont)

s-Circuit for measuring triode characteristics.

t,u-Typical triode characteristics, the tube to which these curves refer has a plate resistance of 4,000 ohms, a mutual conductance of 4 milliamperes per volt and an amplification factor of 16.

v-Circuit of resistance-capacity coupled amplifying stage; the condenser "blocks" the direct-current component of the anode-to-cathode voltage.

w-Typical characteristics of a screen-grid tube, showing the kink caused by secondary electron emission. This tube is called a tetrode.

x-Typical anode characteristics of a pentode or kinkless tetrode.

y-Construction of a kinkless tetrode (beam tetrode) dotted lines represent electron paths.

z-Enlarged partial section of "y".

**aa,ab**-Details of a beam power tube. A very high density of electrons is obtained by confining them by means of beam-forming plates. The screen grid lies in the electronic shadow of the control grid. The beams prevent stray secondary-emission electrons from reaching the screen grid.

ac-Construction of grid #1 in a remote cut-off pentode. (Radio Corporation of America)

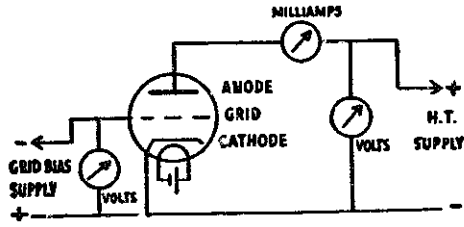

S

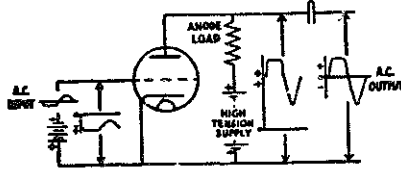

V

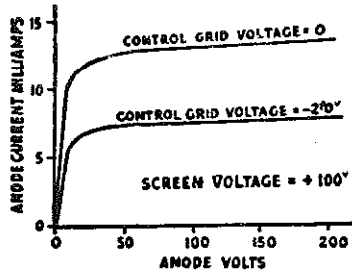

X

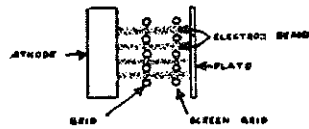

aa

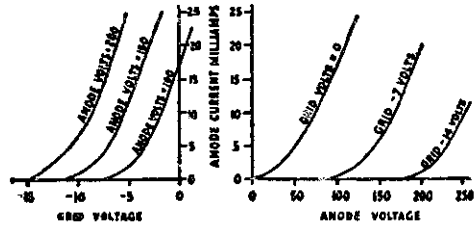
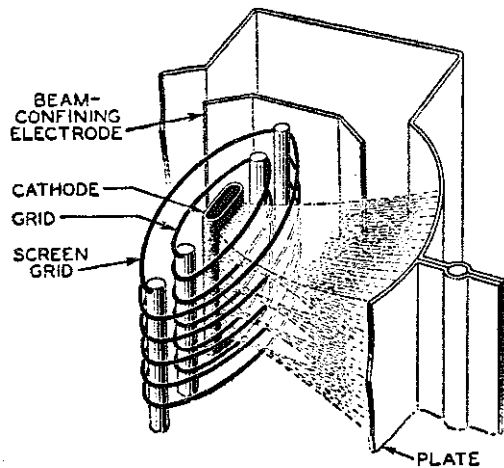

t

u

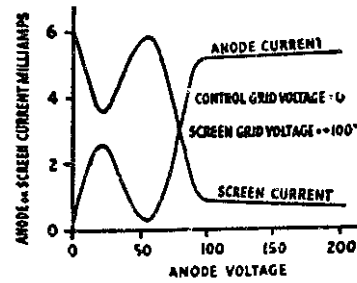

W

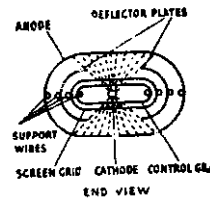

Y

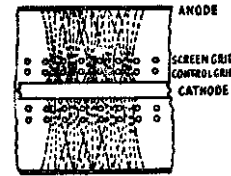

Z

a b

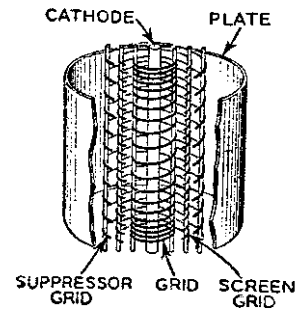

a c

## D-Electronic Devices

### 2-CATHODE AND X-RAY TUBES

a-Deflection of a **cathode** ray by means of a magnet revealed by the effect on a fluorescent screen.

b-Deflection of **cathode-ray tube**; it is a long cylindrical vacuum tube containing two electrodes. a mica diaphragm with a slit at its center, and a long rectangular sheet of mica covered with a fluorescent salt; a discharge from the cathode passes through the slit and causes a stream of fluorescent light along the mica slit; ~~that~~ this stream consists of negatively charged particles can be shown by means of a strong magnet whose north pole will attract the stream and whose south pole will repel the stream.

c-Focus tube; it consists of a vacuum tube with a concave cathode and a sheet of thin platinum foil at the center of the curved surface; when a discharge is sent through the tube, negatively charged particles fly off the cathode normally to the curved surface which centers, or "focuses" them on the platinum foil with sufficient energy to heat it red hot.

**d-Crooke's tube**; it consists of a pear-shaped vacuum bulb, 20 centimeters long and 7 centimeters in diameter, mounted horizontally on a wood base; the cathode is at the narrow end, the anode near the broad end and attached to it is a Maltese cross of metal arranged so that it may be set up in a vertical position; when in that position and a discharge is passed through the tube, the cross throws a sharp shadow on the glass, showing that the charged particles which make the glass fluoresce are stopped by the metal cross.

e-Forerunner of cathode ray tube. Used in 1897 by Sir J. J. Thomson to determine the ratio  $\frac{e}{m}$  of electrons. C, cathode; A, anode; B, metal plug;

D,E deflection plates in the vertical electric field; an outside electromagnet sets up a field perpendicular to it. 'The extreme end of the tube is coated with a fluorescent material. Emitted from cathode C are electrons liberated by ion bombardment.

# CATHODE & X-RAY TUBES

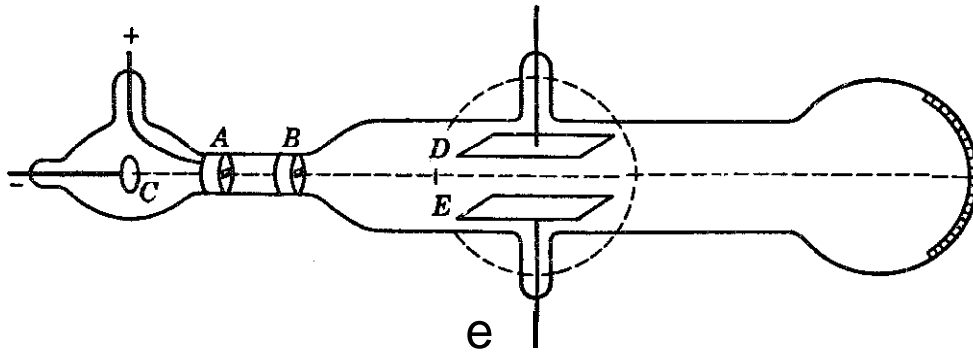
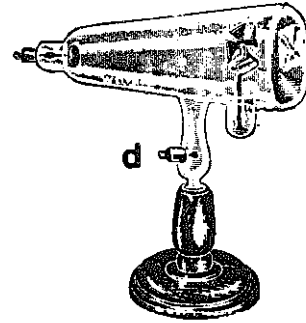
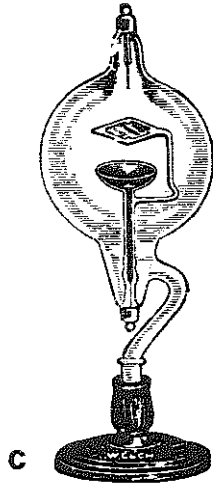
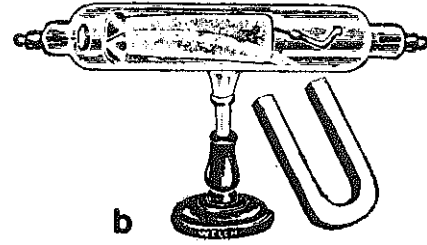
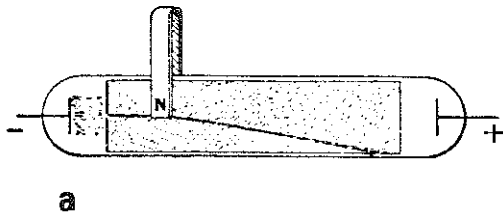

## D-Electronic Devices

### 2-CATHODE AND X-RAY TUBES (Cont)

**f—Electrostatic tube;** electrons emitted from the cathode moving forward; the final anode which is maintained at 500 to 5,000 volts, positive to cathode; the grid surrounding the cathode is made negative to it and repels the electrons some of which escape through a fine hole to form a “point source” of electrons. The number of electrons escaping and the brightness of the spot on the screen are controlled by the grid potential.

**g,h—Electrostatic focusing** with the electrostatic tube of figure “f”. “h” illustrates electric fields between the anodes; the arrows show the direction in which an electron is urged (the reverse of the conventional field direction); “g” shows the paths followed by electrons from the cathode to the screen.

**j—Magnetic tube;** it uses magnetic fields to focus and deflect the magnetic flux; in a cathode-ray tube of this type, an electron moving at right angles to a magnetic field is acted on by a force perpendicular to its direction of motion and perpendicular to the direction of the field; if emitted in a uniform field, in a perpendicular direction to the field, the electron moves in a circle the radius of which is proportional to its speed; the time to describe this circle is independent of the velocity of the electron and inversely proportional to the strength of the magnetic field; no force acts on an electron moving in the direction of a magnetic field; if the electron moves at an angle to a magnetic field, its velocity may be resolved into two components; the component along the field is unaltered; the component at right angles to the field is converted into a circular motion and the resultant path is a helix.

**k—Magnetic focusing** showing paths followed by electrons from a point source to a screen; five electrons are illustrated leaving the point source in different directions with different radial velocities; double-headed arrows indicate the magnetic field.

l-Arrangement of electrodes in an **X-ray tube.**

**m—Electron microscope;** early 1940 model: magnification more than 100,000 times.

**n—Magnetic electron lens.**

**p—Electrostatic electron lens.**

**q—Bragg-type X-ray spectrometer.**

**r—Television picture tube, (1952 design).**

# CATHODE & X-RAY TUBES

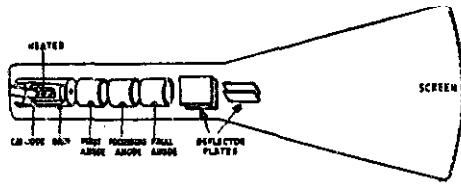

f

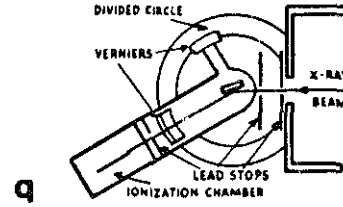

q

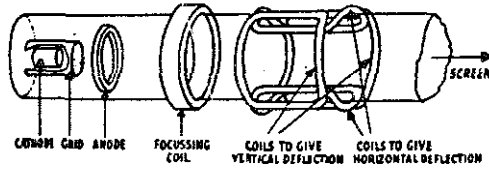

i

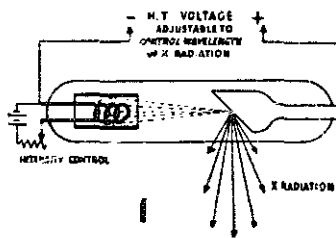

j

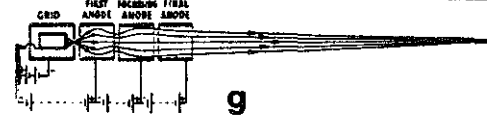

g



h

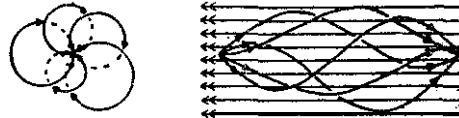

k

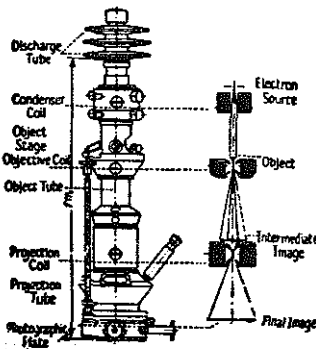

m

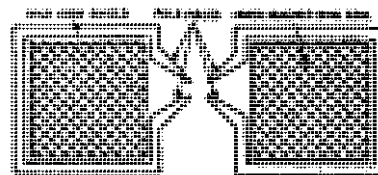

n

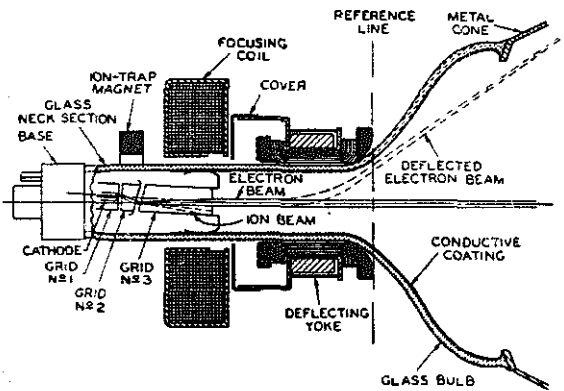

r

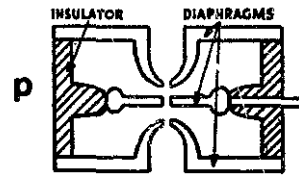

p



## D—Electronic Devices

### 3—GAS FILLED TUBES

a—**Thyratron**, used as a controlled rectifier by regulating the conduction time and, therefore, the average current flow permitted through the tube. The grid of the thyratron can only control the start of conduction, but cannot stop it. Alternating current is used mostly, because the moment the plate goes negative, the grid gains control again.

b—Shield grid **thyatron**. This tube is more sensitive to grid changes.

c—Symbol for “b.”

d—**Thyratron** circuit and relay which operate when the light, which normally reaches the photocell, is cut off.

e—Operation of the relay in reverse direction to that of figure d; the relay operates when light reaches the photocell; used in the “Magic Eye” for opening and closing doors.

f—**Speed control** of motor by variation of the phase angle between grid and anode voltage.

g—**Speed control** and reversal of the motor by means of two gas-filled triodes in a push-pull arrangement.

h—**Ignitron**. A pencil point shaped ignitor rod touches a mercury pool. The ignitor is not wetted, so a small depression surrounds this point. With voltage applied to the ignitor rod by a short pulse, an arc is initiated which ionizes the mercury vapor permitting the main discharge to form. Conduction continuous through the positive half cycle. Electrons from cathode collide with gas molecules, freeing electrons from them (creating ions) so that a greater increased stream reaches the anode.

j—Symbol for the **ignitron**.

k—**Thyratron** used as stroboscope.

l—**Nixie** tube, contains stacked elements in the form of numerals. The anode is common, and each character forms a cathode. Applying voltage to the proper cathode makes only the selected number visible. The visible glow discharge is larger than the metallic number. Used in display panels and the like. (Burroughs Corp.)

m—**A slow transfer tube**. This tube has 30 pin-like cathodes which surround a disc type anode. The tube conducts between the anode and the cathode that has the lowest potential, causing the tip to glow. Ten of the cathodes are output cathodes, and twenty are guide or transfer cathodes. To move to another cathode, the cathode must have a lower potential than the one aglow.

# GAS FILLED TUBES

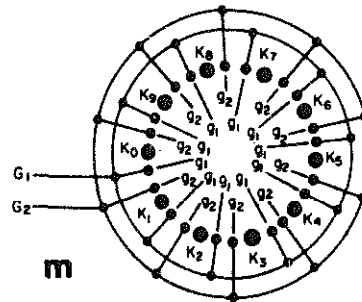
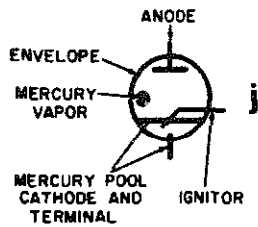
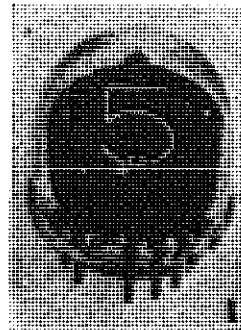
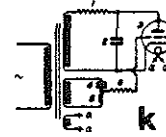
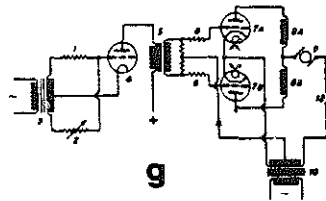
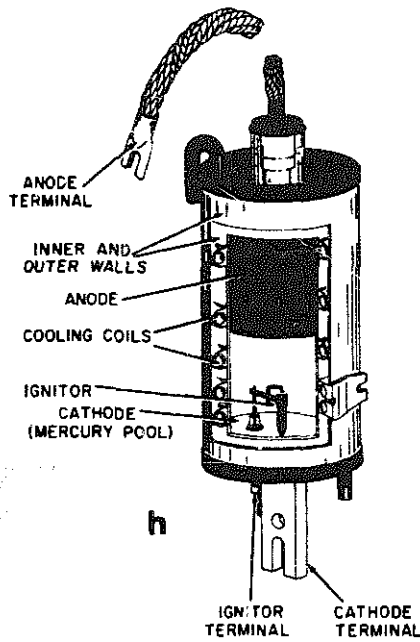
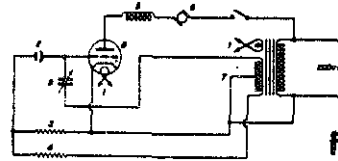
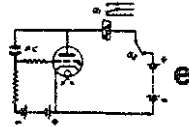
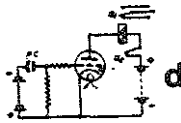
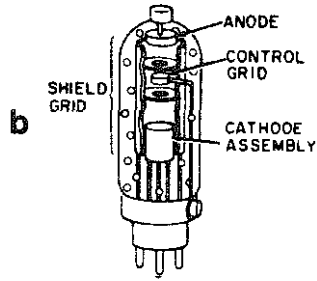
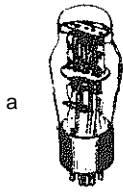

## D—Electronic Devices

### 4—RADIO COMMUNICATION AND AMPLIFIERS

**a**—Wave forms of an **amplitude-modulated transmitter**; simple diagram of the audiosignal and radio-frequency oscillator being combined in the modulator to form the transmitted signal. Shown 100% modulation.

**b**—**Carrier** which is modulated by a simple a-c voltage, starting at point **X**; actually this modulated wave would contain components of at least three radio frequencies; these would consist of the sum and difference of the original frequency and the modulated frequency.

**c**—**Signal** waves in a tuned radio-frequency receiver; variable tuned amplifier stages are adjusted by a single dial to the frequencies of different broadcasting stations between 540 kc to 1,600 kc.

**d**—**Signal** wave forms in a superheterodyne receiver; in a tuned radio-frequency receiver as in figure "c", the receiver is tuned to the frequency of the signal and the signal is amplified at that frequency; while in a superheterodyne receiver the signal is tuned in and then changed in frequency to a lower value to which the intermediate amplifier is tuned and then the signal is amplified at the intermediate frequency.

**e**—**Electrodynamic loud speaker**;  $\kappa$  indicates a cone;  $L_1$ , a voice coil;  $L_2$ , a field coil;  $S$ , a voice-coil support spider.

**f**—**Permanent-magnet loud speaker**;  $PM$  indicates a permanent magnet;  $S$ , a voice-coil support spider;  $\kappa$ , a cone;  $L$ , a voice coil.

# RADIO COMMUNICATION & AMPLIFIERS

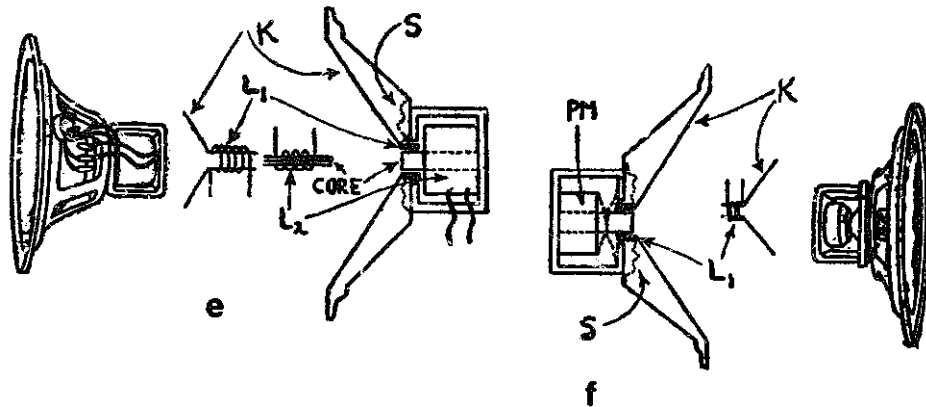
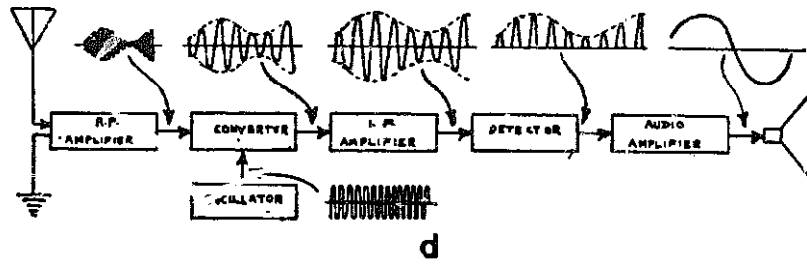
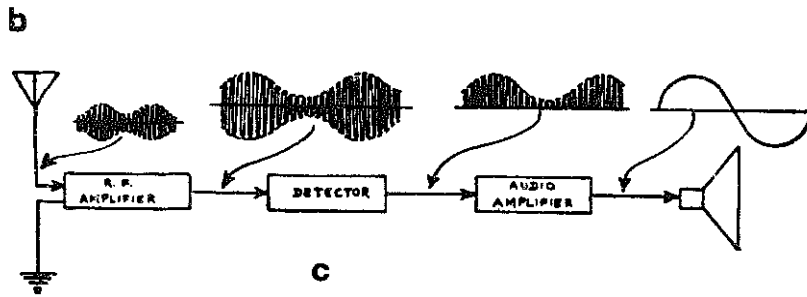
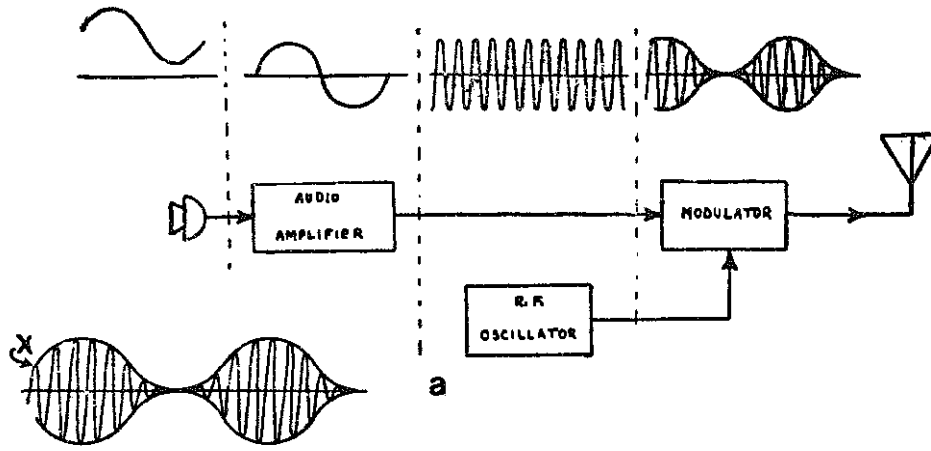

D—Electronic Devices

4—RADIO COMMUNICATION AND AMPLIFIERS (Cont)

h—Currents in a **half-wave rectifier**. Diode only conducts during positive half cycle. Input is a.c., output a pulsating d.c.

j—Currents in a full wave **rectifier**. Since one or the other plate must be positive, current is delivered during each half cycle. Input a.c., output pulsating d.c., twice the amount of current in “h.”

k—**Filter action**. Input pulsating d.c., output d.c. with small ripple. Picture shows the output wave shape after capacitor  $C_1$  and the greater smoothing action after going through inductance coil and filter capacitor  $C_2$ .

l—An **a-c d-c rectifier circuit**.

m—**Tuned radio-frequency** amplifier circuit.

n—**Circuit** for neutralizing grid-to-plate capacity of a triode tube.

p—Circuit using a screen-grid tube.

q—**Resistance-coupled** radio-frequency amplifier circuit.

r—**Tickler feedback** oscillator circuit.

s—**Hartley oscillator**.

t—**Intermediate-frequency** amplifier circuit.

u—Effect of a **by-pass condenser** across a cathode bias resistor.

v—**Diode detector circuit**.



## D-Electronic Devices

5—SEMICONDUCTOR DEVICES. Silicon and Germanium are the materials most often used for semiconductor devices.

a--To the carefully prepared crystal lattice structure impurity atoms are added with one more or one less valence electron. Shown is an atom with one more electron. We have a n-type material. If the impurity would have only 3 valence electrons, we would have a p-type material.

b-Joining an n-type with a p-type (called p-n junction) an interaction takes place at the junction, creating a small space charge region. Thermal energy creates a diffusion current which is balanced by a drift current due to the created voltage barrier.

c—**Electron current** flow for a reverse biased junction. The flow is minute, the space charge region has been widened.

d—**Electron current flow** in forward biased junction. The space charge region has been reduced.

e—**NPN Transistor**. Going in the direction of the arrow, we have emitter, base and collector section. The emitter to base section is forward biased; the base to emitter section reverse biased. The base section is very thin, so most of the electrons pass through to the collector. If the n and p-type sections are interchanged, and the battery voltages reversed we have a PNP transistor.

f—Symbol: **NPN transistor**.

g—Symbol: **PNP transistor**.

h—**Transistor** in common emitter connection.

j—**Transistor** in common base connection.

k—**Transistor** in common collector connection.

l—**Biasing**. One battery is eliminated, and bias is obtained by a voltage dividing resistor network. Circuit identical to "h."

# SEMICONDUCTOR DEVICES

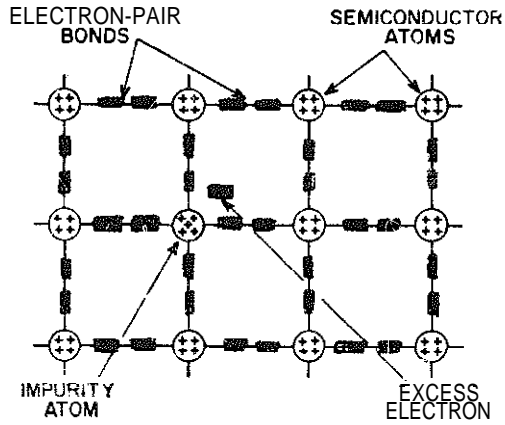

a

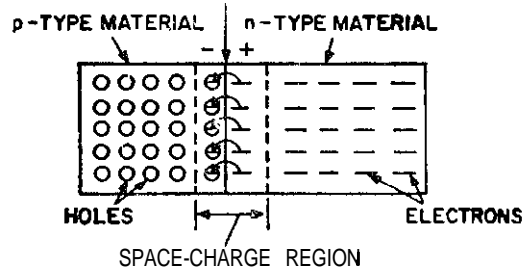

b

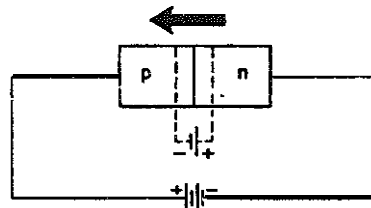

d

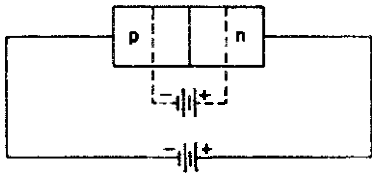

c

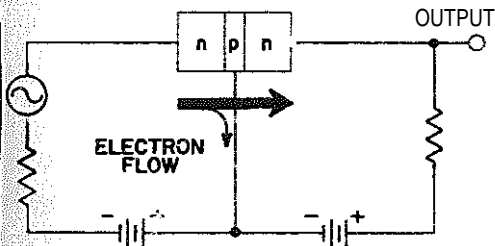

e

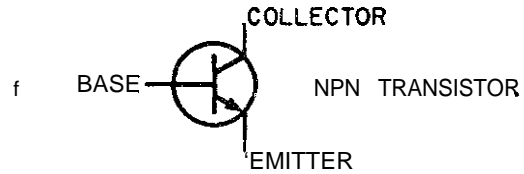

f

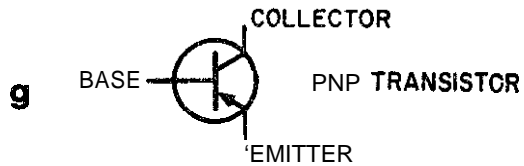

g

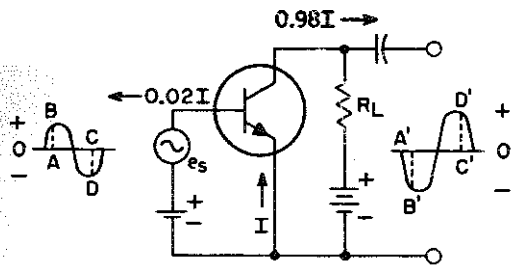

h

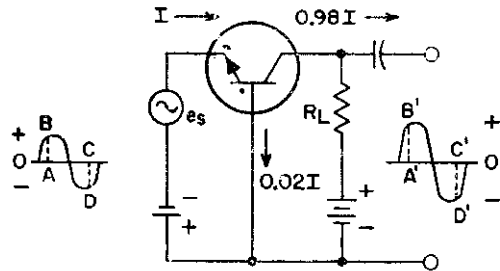

j

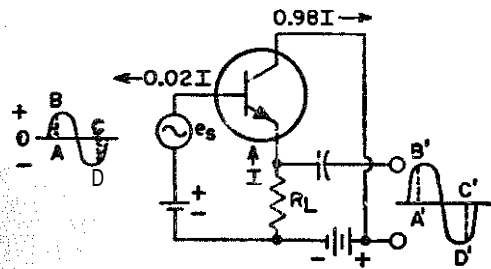

k

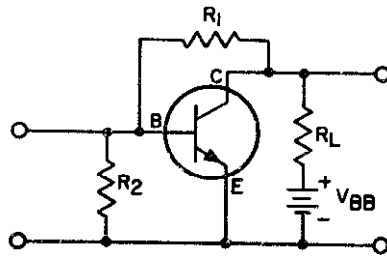

l



## D—Electronic Devices

### 5—SEMICONDUCTOR DEVICES (Cont)

**m-NPN tetrode transistor.** Primarily for high frequency use. A second base lead is added and with proper cross base bias an electric field is established which compresses the active base region.

**n—Typical biasing circuit** for tetrode in common emitter configuration.

**p—SCR symbol** (silicon controlled rectifier), of the thyristor family. Basically a p-n-p-n. Acts the same way as a thyratron tube. At low forward bias the SCR has a high impedance (off state). As forward bias on gate is increased, the SCR switches to the “on” state. Now the forward current is limited by the external impedance.

**q-Voltage-current** characteristic for SCR.

**r—RC triggering network** for SCR with phase control triggering.

**s—Triac symbol.** The triac has three electrodes called “main” terminal No. 1, “main” terminal #2 and gate. Its voltage-current characteristic is the same as that of the SCR for forward blocking and forward conducting, but for either polarity of the main terminals.

**t-Voltage current** characteristic for triac.

**u—Comparison of control possibilities of SCR vs triac.**

**v-Diode.** Simplest type of semiconductor. Arrow points in direction of conventional current flow (+ to -). Conducts in one direction easier than in the other. Also used for spark suppression.

**w-Disc.** A bidirectional avalanche diode. Can be switched from “off” to “on” state for either polarity.

**x-voltage-current** characteristic for diac.

# SEMICONDUCTOR DEVICES

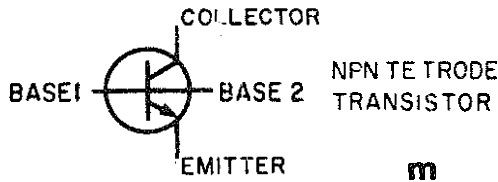

m

n

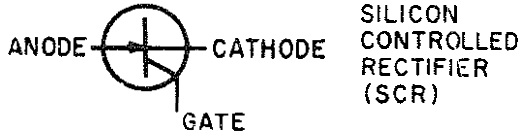
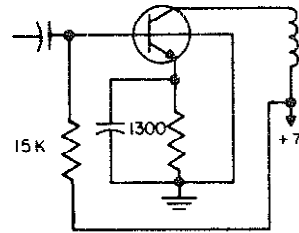

p

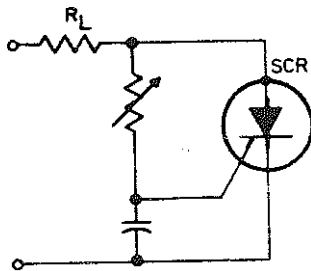

r

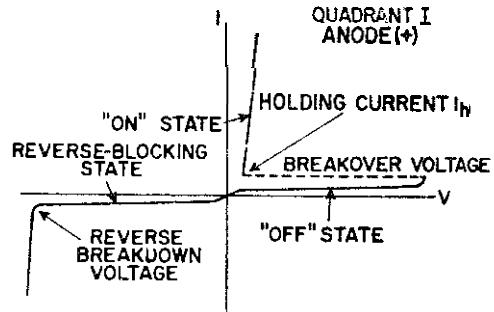

q

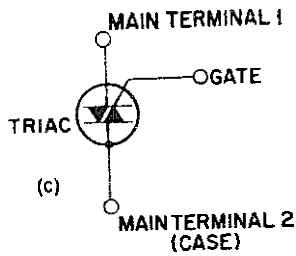

s

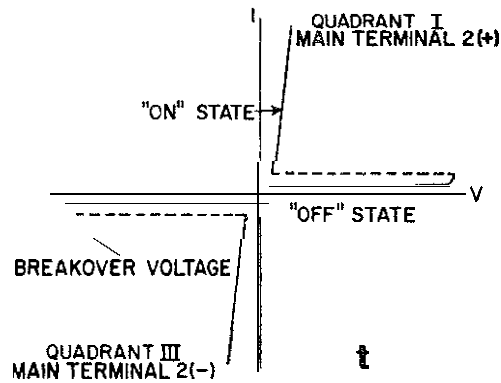

t

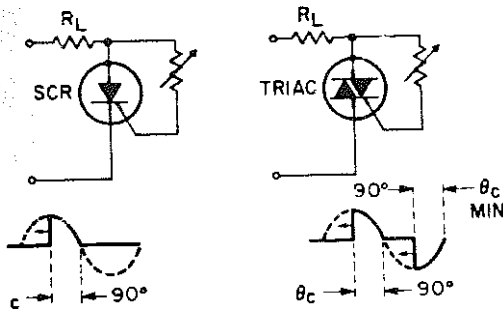

u

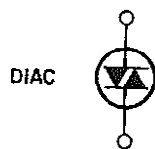

w

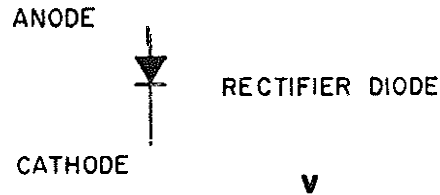

v

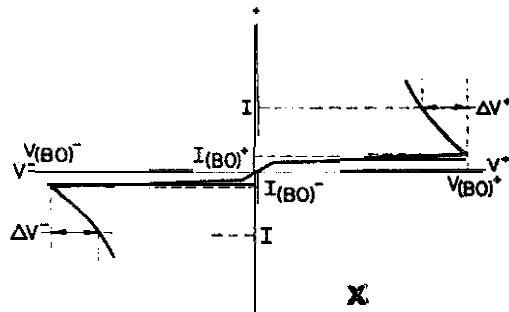

x

D—Electronic Devices

5—SEMICONDUCTOR DEVICES (Con:)

**y-Zener diode.** This diode has controlled reverse-biased properties making them very useful as voltage reference devices.

**z—Voltage-current characteristic for zener diode.**

**aa—Symmetrical zener diode.**

**ab,ac—Two symbols for the tunnel diode.** It is assumed that the tunnel diode operates on a quantum theory principle where a particle goes from one side to the other of a potential barrier although lacking the energy to go over it. This is called the tunnel effect.

**ad—Voltage current characteristic of tunnel diode.** Note how sharply current drops as voltage is increased (negative characteristic), and then rises again.

**ae-Trigistor.** A positive trigger pulse to base turns the trigistor on. It will stay on until a negative trigger pulse to base turns it off.

**af-Unijunction transistor.** Used as a switch. Can be connected in many ways. Usually  $B_1$  goes to ground, and interbase potential  $V_{BB}$  is applied between  $B_1$  and  $B_2$ . With no emitter current the basic silicon bar acts as a voltage divider, with a certain fraction of  $V_{BB}$  at the emitter. If emitter voltage is less than that, emitter is reverse biased, and only a small current flows. If the emitter voltage is higher, unit is forward biased and emitter current flows.

**ag-Binistor.**

**ah-Four layer diode.** Great power handling ability combined with fast switching. Used in ring counters, oscillators etc. Positive pulse to anode or negative pulse to cathode can put this diode on.

**ai—Symbol—Field effect transistor (JFET).**

**aj—Voltage-current characteristic for four layer diode. Terminology:**

$V_s$ — switching voltage (also $V_b$ )	$R_{on}$ — “on” resistance
$V_h$ — holding voltage	$R_{off}$ — “off” resistance
$I_h$ — holding current	$V_{ra}$ — voltage limiting action in
$I_s$ — switching current (also $I_b$ )	reverse direction

**ak—Field effect transistor.** The terminals are the source, the drain and the gate. The conducting path between source and drain is called channel. This transistor behaves like a vacuum tube. As drain voltage increases, the channel area decreases, until at the pinch off voltage the space charge regions meet. Varying the gate voltage, varies the resistance of the channel, and therefore the current from drain to source.

**al—Characteristic curve for field effect transistor.**

SEMICONDUCTOR DEVICES

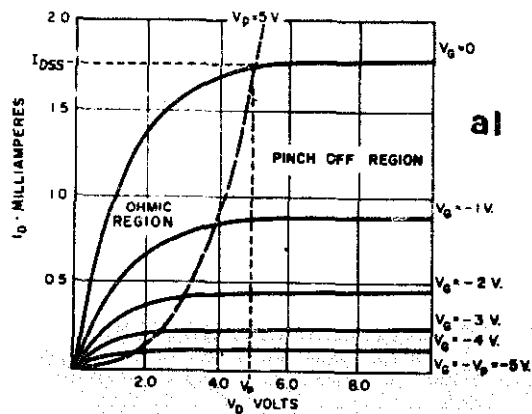
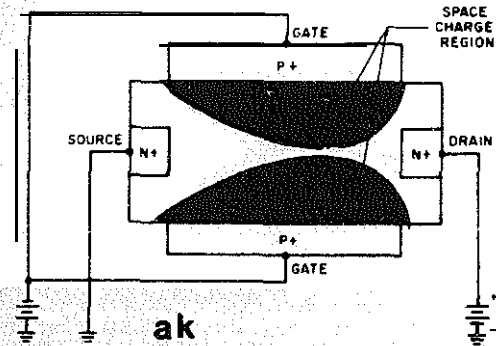
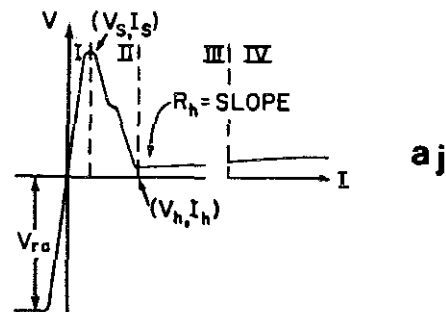
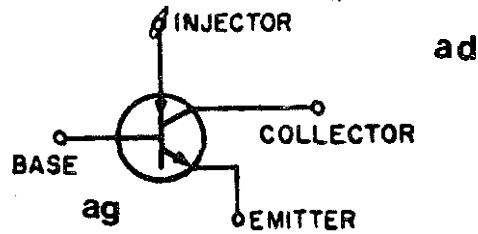
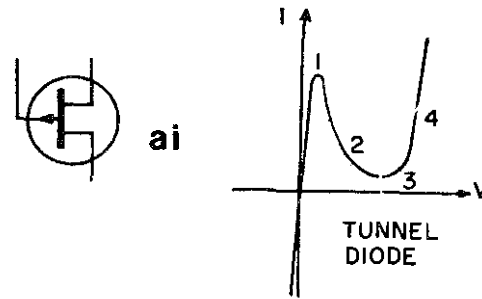
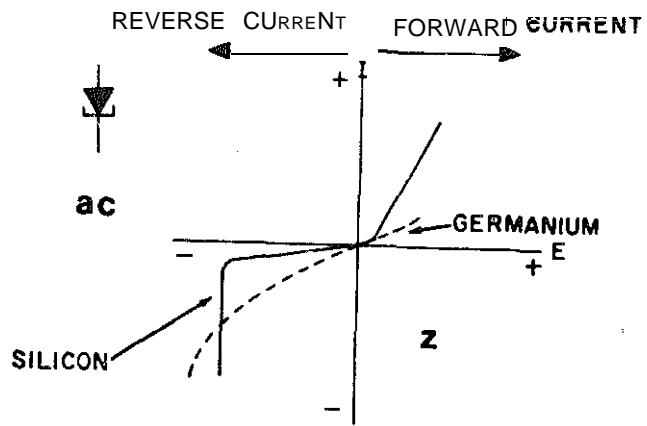
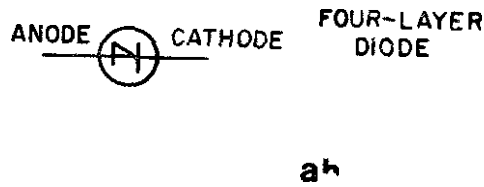
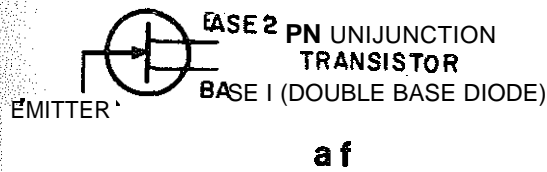
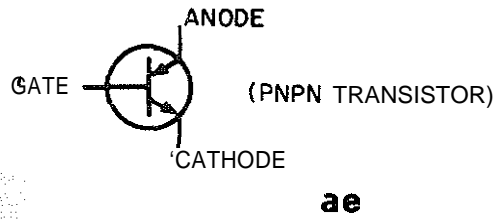
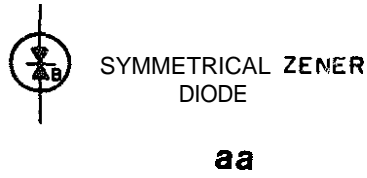
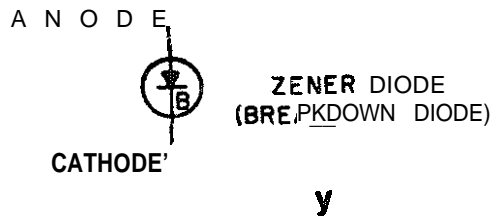

## D—Electronic Devices

### 5—SEMICONDUCTOR DEVICES (Cont)

**am—Mosfet** (Metal-oxide-semiconductor field effect transistor). This is a depletion type n-channel transistor.

**an-Mosfet**, p-channel depletion type.

**a p - M o s f e t**, n-channel, enhancement type. (In the enhancement type operation is with a positive gate-source potential.)

**aq-Mosfet**, p-channel enhancement type.

**ar—Structure of M o s f e t** enhancement type. (RCA) Note: In the depletion type, we have charge carriers in the channel. This channel is conductive even without bias. In the enhancement, active carriers are created only by biasing the gate forward.

**as-Varactor diode**. This is a variable reactance diode. Junction voltage and depletion layer capacitance are in a non-linear relationship.

**at—Characteristic curve of varactor**.

**au - P h o t o c o n d u c t i v e c e l l**. Resistance decreases as intensity of light striking cell increases. (RCA)

**av-High input impedance amplifier**, using JFET in cascade with bipolar transistor. Note circuit symbol for JFET, shown in cross-section at “ak.”

**aw—Complimentary amplifier**, using NPN and PNP transistors. Normally not used for power output.

**ax—Push-pull audio amplifier circuit**, class B.

**ay-Hartley oscillator** using Mosfet. Compare with Hartley oscillator shown in section 4 detail “k.”

**az—Diac triggers triac** in light dimmer circuit.

**ba—Two-stage direct coupled circuit**.



am

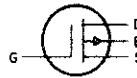

an



ap

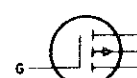

aq

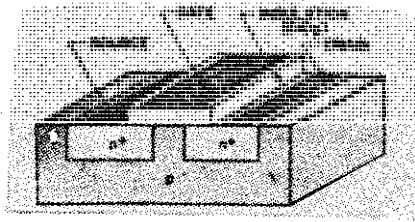

ar



as

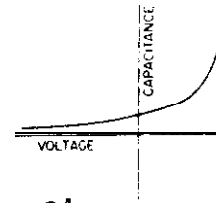

at

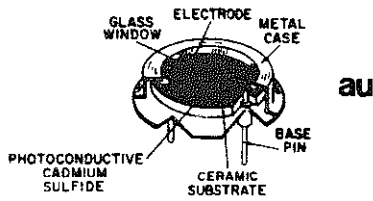

au

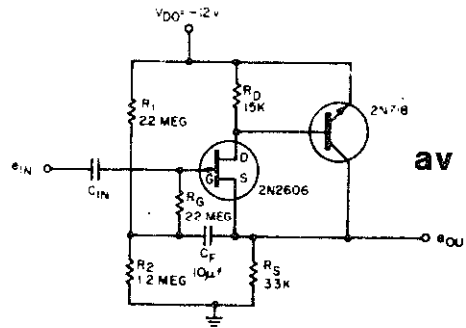

av

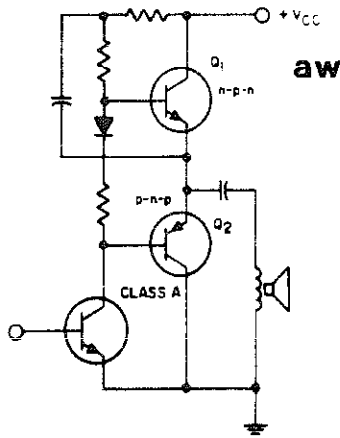

aw

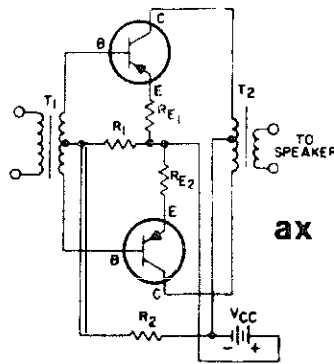

ax

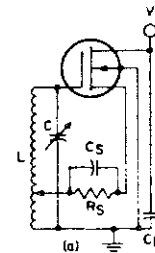

ay

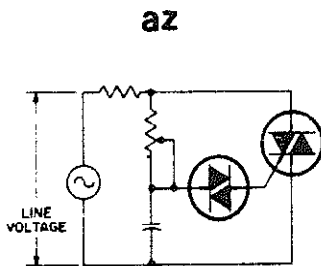

az

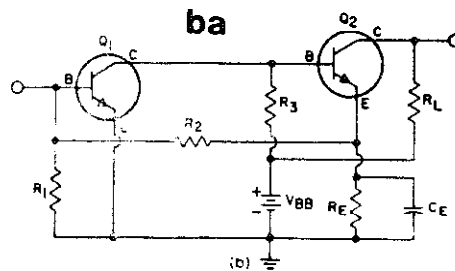

ba

## E-Computer Technology

**1-BINARY ARITHMETIC.** Computers work in a binary mode. This system is so popular, because many electrical and electronic components have only two stable states, on and off. A switch might be open (off = 0) or closed (on = 1); a tube might be conducting (=1) or non-conducting (0); a magnet magnetized in one direction may be represented as 1, while when magnetized in the other direction\*it may be zero; punched cards and punched tapes may indicate ones and zeros; finally, a pulse might represent a one, while its absence may represent a zero.

**a-Binary representation** of numbers zero to 16 (the decimal system). Note that the column value increases by the powers of two. Take the decimal number 13 =

$$\begin{aligned} 1 \times 2^0 &= 1 \\ 0 \times 2^1 &= 0 \\ 1 \times 2^2 &= 4 \\ 1 \times 2^3 &= 8 \\ \hline 1101 &= 13 \end{aligned}$$

**b-Binary coded decimal.** A code to translate each decimal digit individually into an equivalent four bit binary combination. The number demonstrated is 2654.

**c - Addition,** Rules:  $0 + 1 = 1$ ;  $1 + 1 = 10$  or zero and carry 1 to the next position.

**d-Subtraction,** Rules: 1 from zero cannot be done. Borrow from first column where 1 appears and allocate in columns to the right.

**e - Multiplication,** Rules:  $1 \times 1 = 1$ , all other conditions are zero. Multiplication is repeated addition.

**f-Division,** Rules: Division is repeated subtraction

# BINARY ARITHMETIC

Decimal Value	Place Value				
	16	8	4	2	1
0	0	0	0	0	0
1	0	0	0	0	1
2	0	0	0	1	0
3	0	0	0	1	1
4	0	0	1	0	0
5	0	0	1	0	1
6	0	0	1	1	0
7	0	0	1	1	1
8	0	1	0	0	0
9	0	1	0	0	1
10	0	1	0	1	0
11	0	1	0	1	1
12	0	1	1	0	0
13	0	1	1	0	1
14	0	1	1	1	0
15	0	1	1	1	1
16	1	0	0	0	0

Decimal Digits	2	6	5	4
Binary Value	0 0 1 0	0 1 1 0	0 1 0 1	0 1 0 0

DECIMAL  
EQUIVALENT

CARRY NOTE      ( 1 1 1 )

ADDEND	0 0 1 1	=	3	(c)
AUGEND	0 1 0 1	=	5	
SUM	<u>1 0 0 0</u>	=	8	

BORROW      (1)      DECIMAL  
EQUIVALENT

MINUEND	1101010	=	196	(d)
SUBTRAHEND	<u>  10010</u>	=	- 18	
	1011000	=	88	

(e)      MULTIPLICAND: 1101      = 13      1101 = +13

          MULTIPLIER    X 101      = X 5      +1101 = +13

1101	or	+1101 = +13
0000		+1101 = +13
<u>1101</u>		<u>+1101 = +13</u>

(f)      1000001      = 65      1000001      65

DIVIDE       $\frac{130}{43} = 3, \text{ remainder } 1$

### REPEATED SUBTRACTION

#### LONG DIVISION

101011	$\begin{array}{r} \underline{011} \text{ (= 3 answer)} \\ 1000010 \\ - 101011 \\ \hline 0101100 \\ - 101011 \\ \hline 000001 \text{ (remainder)} \\ = 1 \end{array}$
--------	--

10000010	
- 101011	(1X)
1010111	
101011	(2X)
101100	
101011	(3X)
000001	(remainder = 1)



**E-Computer Technology**

2-DIGITAL COMPUTERS. The digital computer is a machine which automatically follows directions. Data and instructions are fed to the machine in prescribed programmed way, and the data are obtained from the selected output unit.

**a-Block diagram** of main functional parts of a computer.

**b--Punched card code.** One means of entering information into the computers memory.

**c-Magnetic tape reel**—input or output.

**d-Paper tape reel**—input or output.

**e-Input:** 8 channel punched paper tape.

**f-Input:** 7-track **magnetic tape** arrangement; 7-bit alphameric code  
Note even parity check column.

**g-Output:** high speed print-out.

**h-Perforated tape reader.** (Teletype Corp.)

# DIGITAL COMPUTER

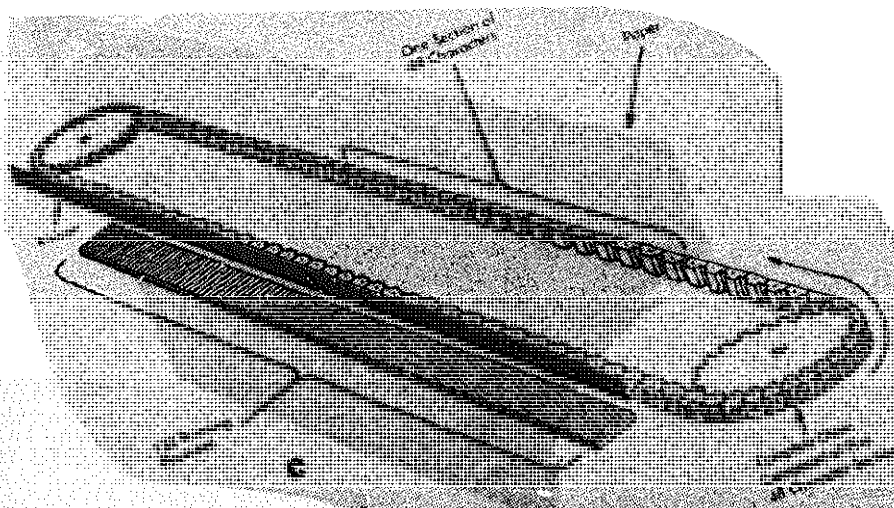
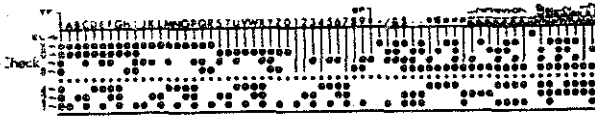
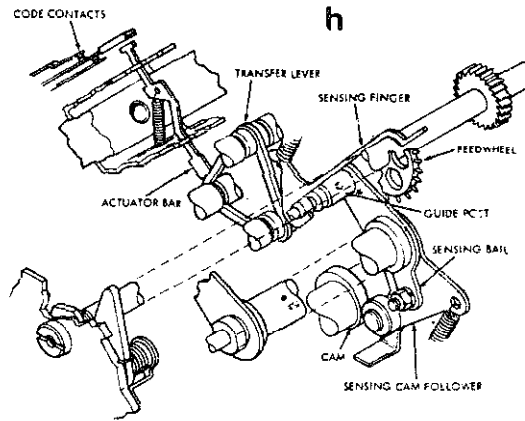
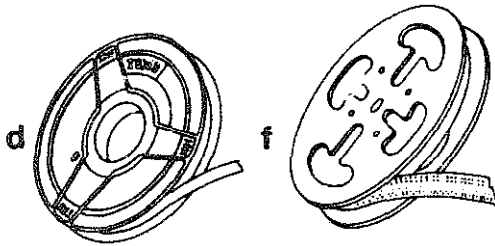
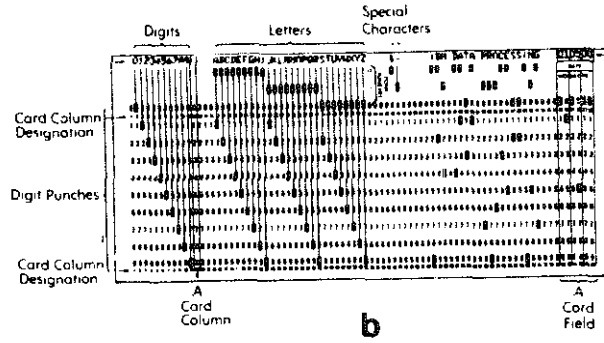
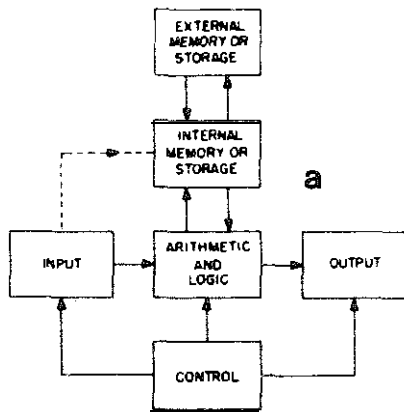

## E—Computer Technology

### 3—STORAGE ELEMENTS

**a-Magnetic Ferrite core.** Magnetized counter clockwise, representing a zero. One magnetic core can only store one bit.

**b-Magnetic ferrite core.** Magnetized clockwise, representing a one.

**c-Memory plane.** Shows core wiring (ferroxcube). Several planes are needed to represent a letter etc.

**d—Location of a letter in core memory.**

**e - Core switching.** The only core switched is the one, where the half-current carrying wires intersect.

**f—Simplified view of magnetic core memory, showing read-out bus.**

**g - Discs.** The capacity of disc storage depends on the number of discs on each stack, number of stacks, recording density etc. Tracks are on both sides of the disc, and each track has several hundred characters.

**h - Magnetic drum storage.** Shown are some tracks and recording heads or read heads.

# STORAGE ELEMENTS

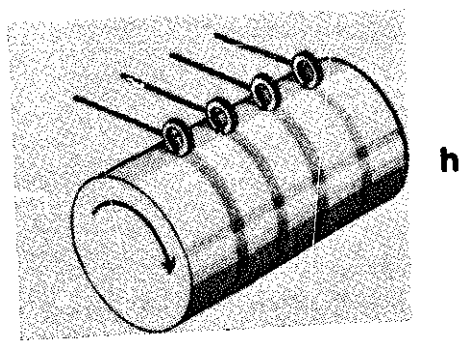
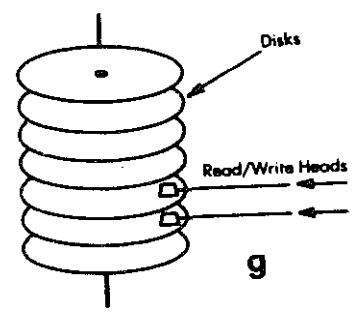
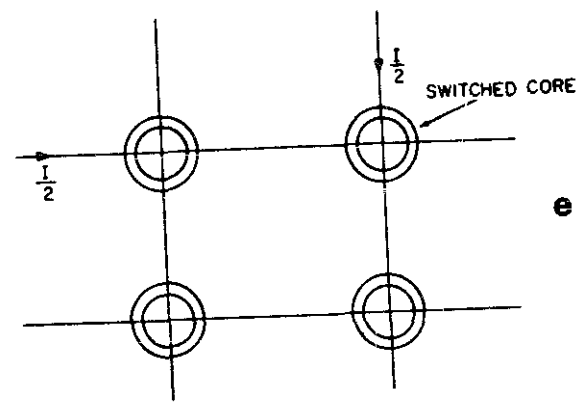
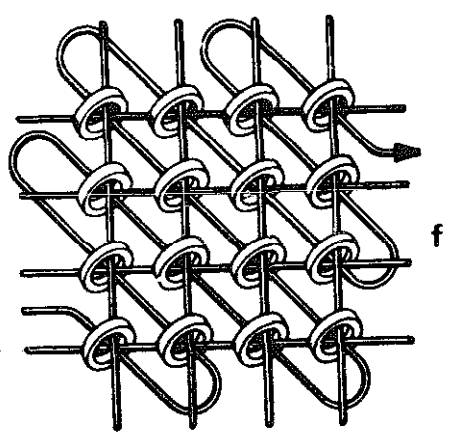
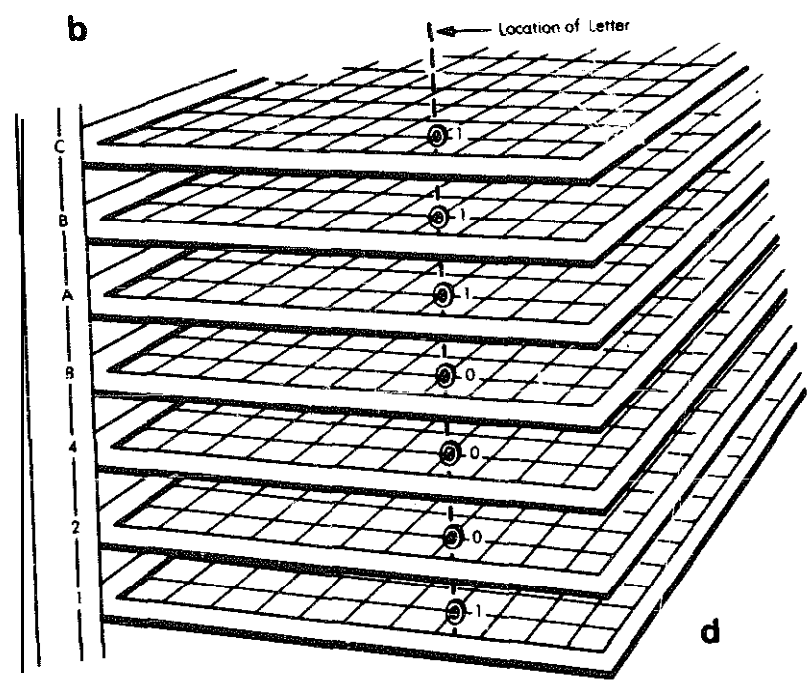
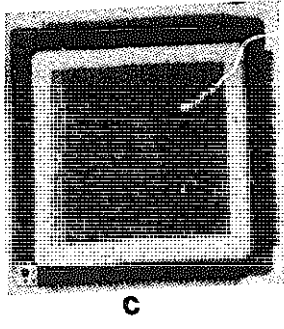

## E-Computer Technology

4-COMPUTER LOGIC (BOOLEAN ALGEBRA). Variables of logic algebra have only two values; true or false; one (1) or zero (0); pulse or no pulse; closed switch or open switch etc. With two variables we have four possible combinations; OFF-OFF (0,0), OFF-ON (0,1), ON-OFF (1,0) and ON-ON (1,1). Graphical aids are truth tables, truth charts and Venn diagrams.

a-NOT (negation). Normally closed switch represents zero. Opened switch represents one. C is (not A); written  $C = \bar{A}$ .

b-AND (logical product). Output signal of true (1) is obtainable only if all inputs (here 2 only) are simultaneously true (1).  $C = A \cdot B$ .

c-AND (logical product).  $C = A \cdot \bar{B}$  (C equals A and (not B)).

d-OR (logical sum).  $C = A + B$  (C equals A or B).

e-OR (logical sum).  $C = \bar{A} + B$  (C equals (not A) or B)

f-NOR (joint denial).  $C = \bar{A} \cdot \bar{B}$

AND NOT  $C = A + B$

	Arithmetic Statement	Electrical Equivalent	Truth Chart	Venn Diagram	Logic Symbol
a	$C = \bar{A}$				
b	$C = A \cdot B$				
c	$C = A \cdot \bar{B}$				
d	$C = A + B$				
e	$C = \bar{A} + B$				
f	$C = \bar{A} \cdot \bar{B}$ $= \overline{A + B}$				

## E—Computer Technology

### 4—COMPUTER LOGIC (Cont)

g—Nand.  $C = \overline{A + B}$ ;  $C = \overline{AB}$

h—Exclusive OR;  $C = A\overline{B} + \overline{A}B$ ; C is true if A is true and B is false or A is false and B is true.

j—Logical equivalence.  $C = A\overline{B} + \overline{A}\cdot\overline{B}$ ; C is true if  $A = B$ , false when  $A \neq B$ . True if A and B are true, or if both A and B are false.

k—Logical sums.

l—Logical products.

Arithmetic Statement	Electrical Equivalent	Truth Chart	Venn Diagram	Logic Symbol
$C = \overline{A+B}$ $\overline{A \cdot B}$				
$C = A \cdot \overline{B} + \overline{A} \cdot B$ $= A \oplus B$				
$C = A \cdot B + \overline{A} \cdot \overline{B}$				

**k**

$$A + 0 = A$$

$$A + 1 = 1$$

$$A + A = A$$

$$A + \overline{A} = 1$$

$$A + AB = A$$

$$A + \overline{A}B = A + B$$

**l**

$$A \cdot 0 = 0$$

$$A \cdot 1 = A$$

$$A \cdot A = A$$

$$A \cdot \overline{A} = 0$$

$$A(A + B) = A$$

$$A(\overline{A} + B) = A \cdot B$$



**E—Computer Technology**

**4—COMPUTER LOGIC (Cont)**

m—Negation of logical sum (De Morgan's rules) (complement).

n—Negation of logical product (De Morgan's rules) (complement).

**Laws of Rearrangement**

p—Commutative law.

q—Commutative law.

r—Associative law.

s—Associative law.

t—Distributive law.

u—Distributive law; no existing equivalent in conventional algebra.

v—Distributive law.

- m)  $\overline{A+B} = \overline{A} \cdot \overline{B}$
- n)  $\overline{A \cdot B} = \overline{A} + \overline{B}$
- p)  $A+B = B+A$
- q)  $AB = BA$
- r)  $A \cdot (B \cdot C) = (A \cdot B) \cdot C = ABC$
- s)  $A+(B+C) = (A+B)+C = A+B+C$
- t)  $A \cdot (B+C) = AB+AC$
- u)  $A+B \cdot C = (A+B) (A+C)$
- v)  $(A+B) (A+C) (A+D) = A+BCD$

E-Computer Technology

5-TRUTH TABLES AND LOGIC CIRCUITS

**a-Transistor NOT (inverter).** PNP transistor used. Collector current is cut off in absence of input, and the negative supply voltage is on the collector. Applying a negative pulse to the base puts transistor into "on" state. Voltage rises to ground potential.

**b-Truth table for NOT circuit.**

**c-Diode OR gate for positive inputs.** If any diode is pulsed to conduct, current will flow and an output will be obtained. The other two diodes will be back biased, and are unable to conduct.

**d-Truth table for OR gate, for 2 inputs.**

**e-Diode AND circuit.** Normally, if any diode is at the zero level, this diode conducts keeping the output at zero. If all input levels are high, the diodes are cut off, and the output reaches the logical "1" level.

**f-Truth table for AND circuit, for 2 inputs.**

**g-Diode-transistor NOR gate (DTL = diode transistor logic).** The transistor circuit is a NOT circuit (see "a"), and the diodes form an OR circuit (see "c").

**h-Truth table for NOR circuit for 2 inputs.**

# TRUTH TABLES & LOGIC CIRCUITS

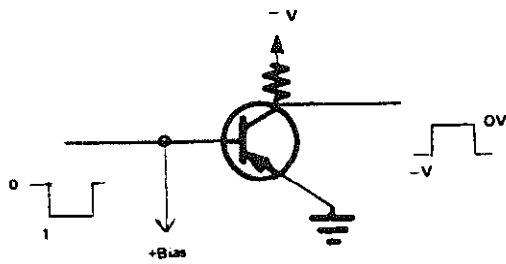

(a)

INPUT	OUTPUT
0	1
1	0

(b)

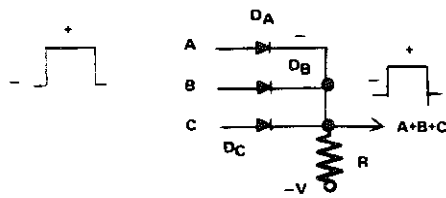

(c)

INPUT		OUTPUT
A	B	A+B
0	0	0
0	1	1
1	0	1
1	1	1

OR GATE FOR 2 INPUTS

(d)

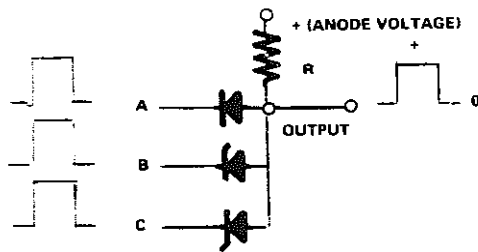

(e)

A	B	A·B
0	0	0
0	1	0
1	0	0
1	1	1

AND GATE FOR 2 INPUTS

(f)

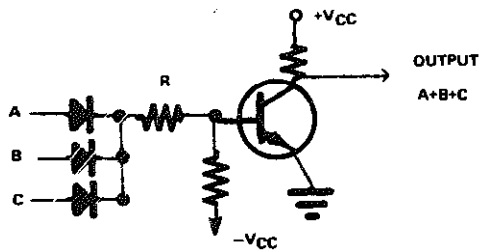

(g)

INPUT	INPUT	OUTPUT	
A	B	A+B	$\overline{A+B}$
0	0	0	1
0	1	1	0
1	0	1	0
1	1	1	0

NOR GATE FOR 2 INPUTS

(h)

E-Computer Technology

5-TRUTH TABLES AND LOGIC CIRCUITS (Cont)

a—**Bistable multivibrator** (flip-flop) circuit. Shown is a basic flip-flop circuit with steering circuits ( $D_s, R_s$ ). Steering circuits are required, so that both transistors can be operated from a single pulse source. The capacitors  $C_1$  are called commutating or switching capacitors, and their purpose is to speed up the operation. Note that we have two NPN transistors. Assume  $Q_1$  is conducting and, therefore, the voltage on the collector of  $Q_1$  is low. A negative pulse arrives at the input.  $C_{IN}$  acts like a short for an instant and the base voltages of both transistors are lowered.  $Q_2$  is already off, and is not influenced, but  $Q_1$  is conducting and is now cut off. Collector voltage of  $Q_1$  rises sharply, raising the base voltage of  $Q_2$ ; now  $Q_2$  is on and  $Q_1$  is off etc., etc.

b—**A half adder** built up with NOR gates. Half adders perform binary addition of two numbers, obtaining the sum and produce a carry. They cannot take care of a carry from a lower order column. Two half adders are required for the complete binary addition.

NOR gate #1	inputs	A, B;	Output	$A + B$
NOR gate #2	input	A;	Output	$\overline{A}$
NOR gate #3	input	B;	Output	$\overline{B}$
NOR gate #4	input	A, B;	Output	$\overline{A + B} = \overline{A \cdot B} = A \cdot B$
NOR gate #5	input	A+B, A·B	Output	$\overline{A+B + AB} = \overline{A \cdot B + A \cdot B}$

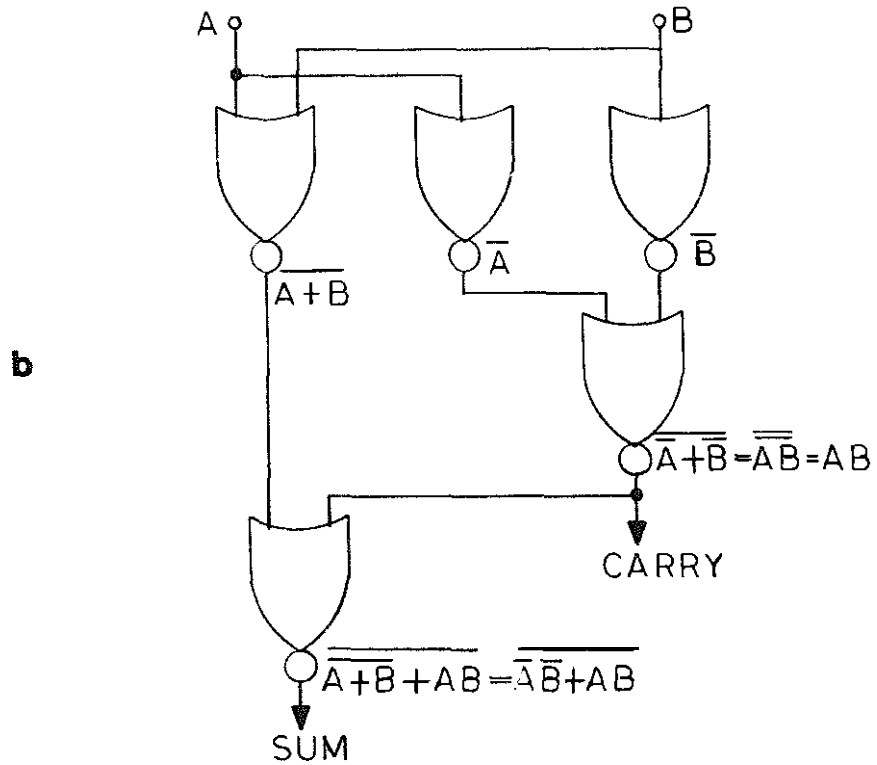
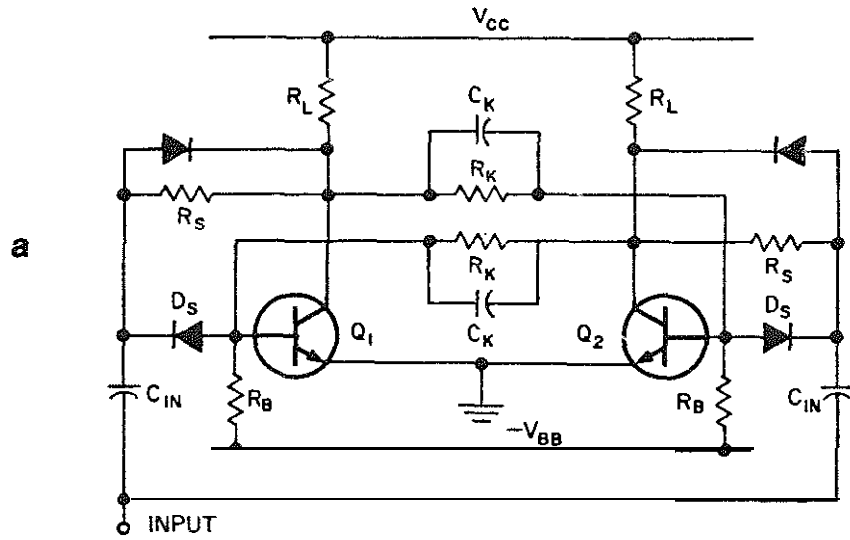

### III LIGHTS AND OPTICS

#### A—Light Sources

**1—LUMINAIRES AND LIGHT DISTRIBUTION.** For purposes of illumination we define light as visually evaluated energy. In the electromagnetic spectrum this visible energy comprises a narrow band from about 4000 to 7000 Angstroms.

**a,b,c—Shallow-bowl reflectors and shields;** distribution downward zero; upward 75 per cent.

**d,e,f—Translucent bowls;** distribution downward 15 per cent; upward 65 per cent.

**g,h,j—White glass enclosing globe or projecting luminous element with cased opal panels;** distribution downward 45 per cent; upward 35 per cent.

**k,l,m—Parabolic polished metal reflectors;** distribution downward 50 per cent.

**n,o,p—Large-area diffusing panels;** distribution downward 55 per cent; extended trough reflector cased opal glass cover, enameled metal reflector with diffusing cover plates; distribution downward 70 per cent.

**q,r,s,t—High-boy open reflectors;** prismatic mirrored or polished glass; distribution downward 70 per cent.

**u,v,w—Large area diffusing reflectors;** distribution downward 79 per cent.

**x—Fundamental fluorescent-lamp circuit;** fluorescent lamps are tubular bulbs coated inside by a phosphor powder, which is made to glow vividly by passing an electric current through mercury vapor inside the tube; the mercury-vapor emission is produced by electrodes at each end of the tube; fluorescent lamps require as auxiliary equipment a starting switch which momentarily opens and closes the electrode current and a ballast which consists of choke coils and condenser to limit the arc current and correct the power factor of the unit; fluorescent-lighting units generally include two or more tubes in order to provide more illumination and to reduce the stroboscopic effect.

**y—Nonuniform illumination** resulting from wide-spaced units.

**z—Uniform distribution** of illumination.



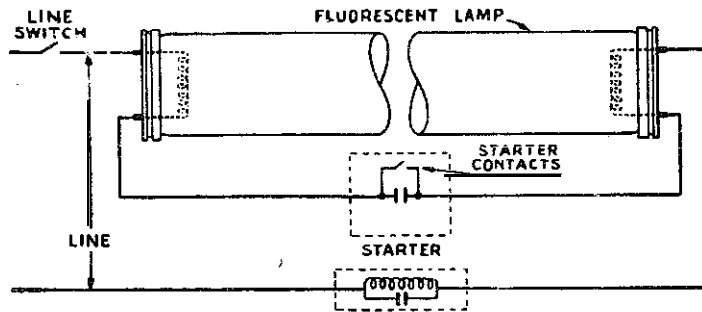
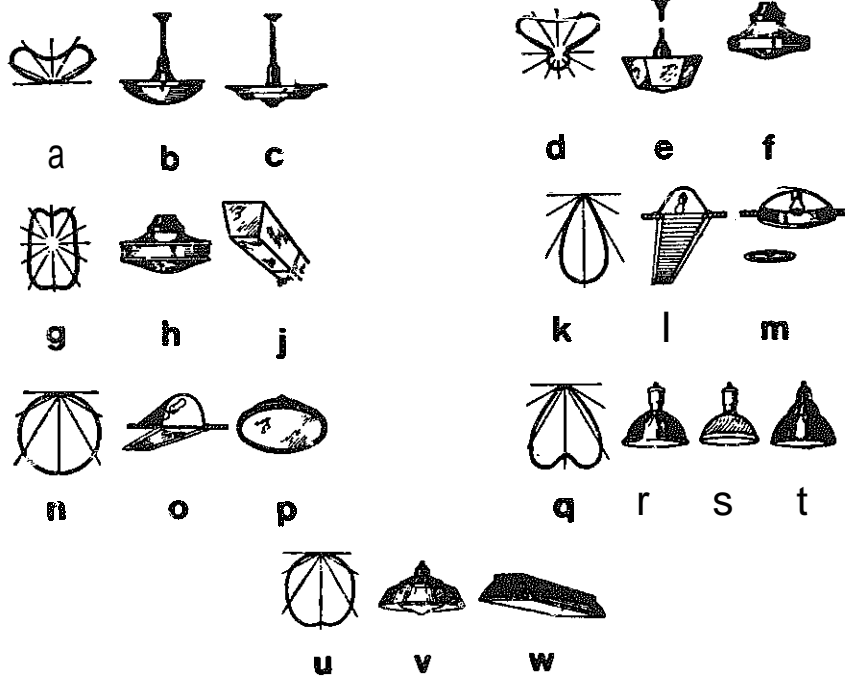

x

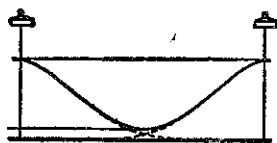

y

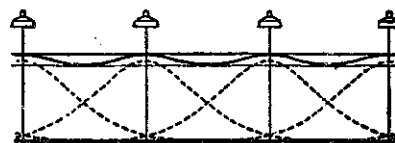

z

**A—Light Sources**

**1—LUMINAIRES AND LIGHT DISTRIBUTION (Cont)**

**aa—Two lamp aluminum troffer** with louvers. (Recessed direct fluorescent).

**ab—Typical distribution** for “aa.”

**ac—Medium distribution reflector** and lens. (Recessed direct general service incandescent).

**ad—Typical distribution** for “ac.”

**ae—Bare lamp unit.** (Surface mounted semi-direct fluorescent).

**af—Typical distribution** for “ae.”

**ag—Louvered coffer** with silvered bowl lamp. (Recessed direct reflectorized incandescent).

**ah—Typical distribution** for “ag.”

**aj—Porcelain-enameled standard dome-incandescent.** (Suspended industrial incandescent and mercury).

**ak—Typical distribution** for “aj.”

**al—Suspended luminous -indirect fluorescent.**

**am—Typical distribution** for “al.”

**an—Direct indirect** with opaque side panels and louvered bottom. Diffused and direct-indirect lighting.

**ap—Typical distribution** for “an.”

**aq—Four bare lamps.**

**ar—Typical distribution** for “aq.”

**as—Chandelier with diffusing shades** (suspended direct -indirect lighting).

**at—Typical distribution** for “as.”

LUMINAIRES

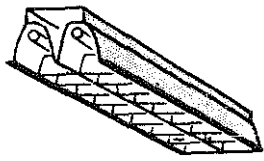

aa

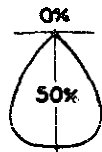

ab

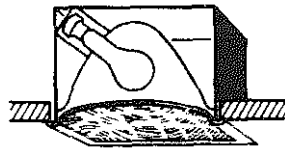

ac

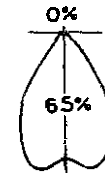

ad

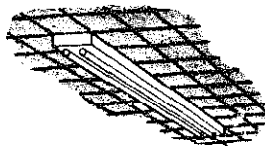

ae

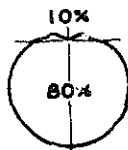

af

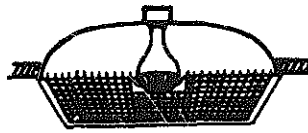

ag

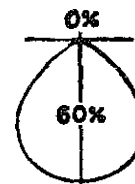

ah



aj

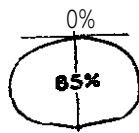

ak

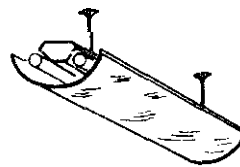

al

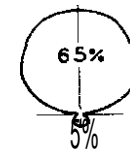

am

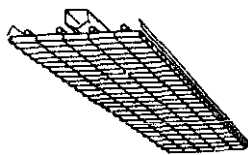

an

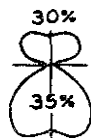

ap



aq

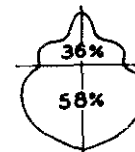

ar

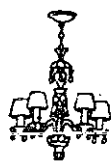

as

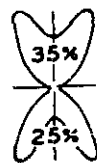

at

**B-Lenses, Prisms and Mirrors**

**1-DEFINITIONS**

**a-Inversions:**  $a_1$ —no inversion;  $b_1$  through  $b_4$ —four inversions in one plane;  $c_1$  inversion in two planes.

**b-Real image,** because rays pass through  $s'$ .

**c-Virtual image,** because rays do not pass through  $s'$ . ( $s'$  is the image of  $s$ ).

**d-Refraction.** Passing from one optical medium to another, light ray will deviate toward the normal in passing into a medium of greater optical density, away for lesser optical density. The light pass is reversible.

**e-Regular reflection.** Because the surface is smooth, the reflected ray lies in the plane of incidence, and angle of reflection  $I'$  is equal to the angle of incidence,  $I$ .

**f-Diffuse reflection,** due to rough surface.

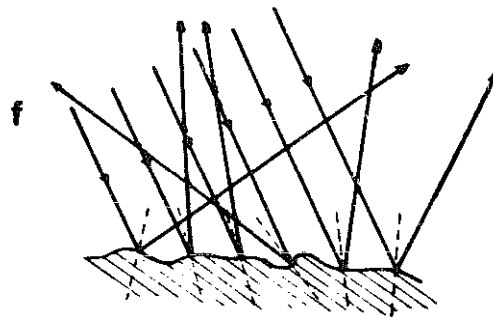
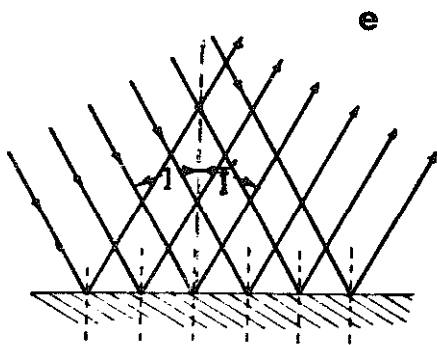
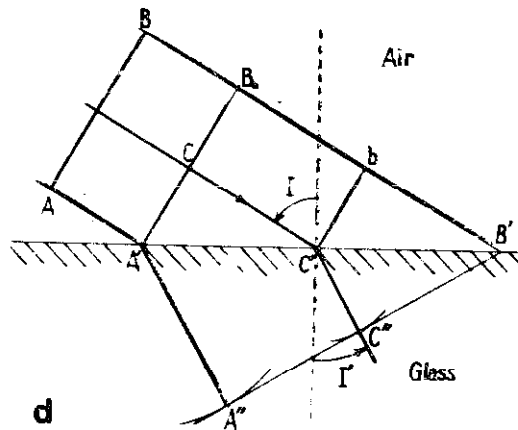
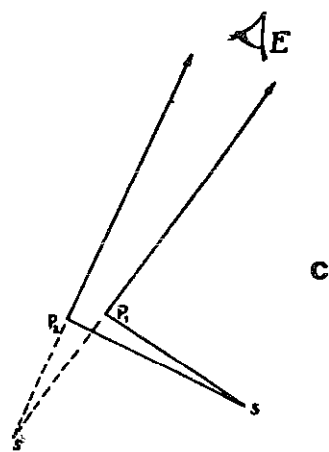
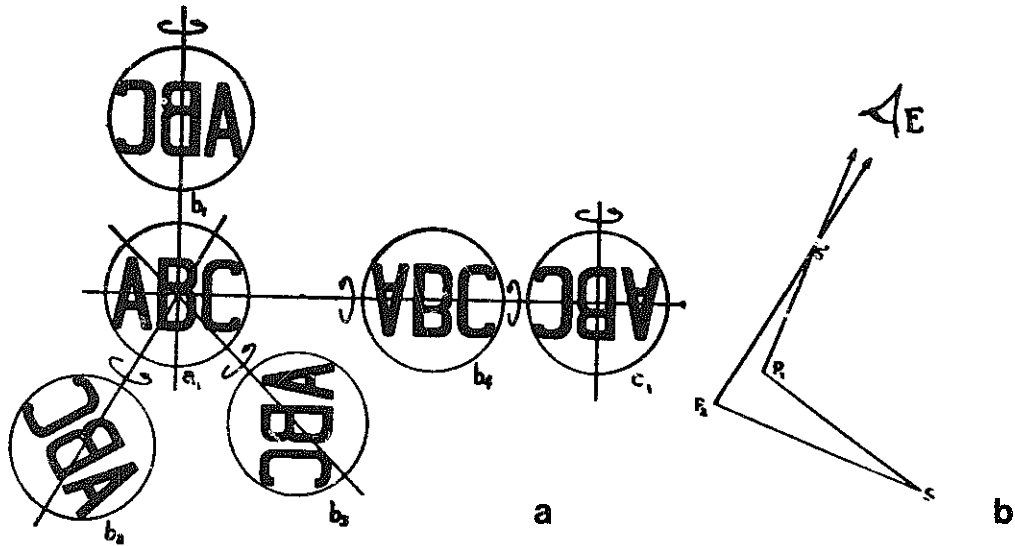

**B—Lenses, Prisms and Mirrors**

**1—DEFINITIONS (Cont)**

**g-Refraction** by plane-parallel plate. **Angle** of refraction at second surface equals the angle of incidence of the first surface.

**h-Paraxial imagery** in a plane parallel plate.

**j-Critical angle.** If ray incident on boundary of medium of lesser optical density, and the angle of incidence exceeds the critical angle, the light is totally reflected at the surface.

**k-Reversals caused by reflecting system.**

**I-Refraction** at plane surface.

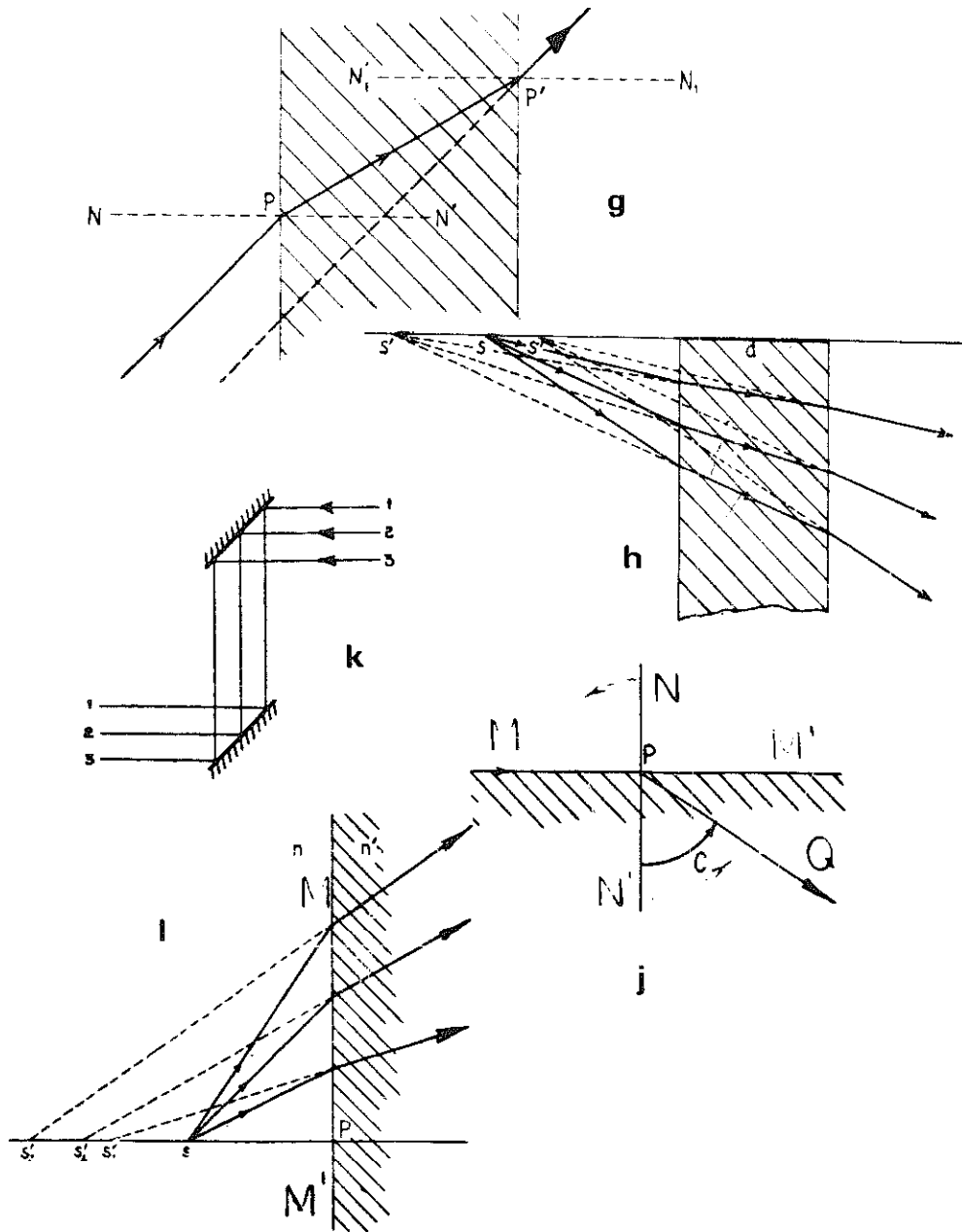

**B—Lenses, Prisms and Mirrors**

**2—MIRRORS.** A mirror is a surface prepared for the purpose of reflecting light.

**a—Light travelling through fiber.** Typical fiber: refraction  $n_g = 1.7$   $n_c = 1.5$ .

**b—Image of an extended object in a plane mirror.** Image is virtual, equal in size to the object, and each point is the same distance behind the mirror as the object is in front.

**c—Two mirrors at a  $90^\circ$  angle.** Will produce three images for every point between the two mirrors.

**d—Location of focus concave spherical mirror.** The principal focus is located on the principal axis AF and halfway between the center of curvature and the mirror surface.

**e—Location of focus of convex spherical mirror.** (Comment same as for “d”).

**f—Location of images formed by concave spherical mirror.**

**g—Location of images formed by convex spherical mirror.**



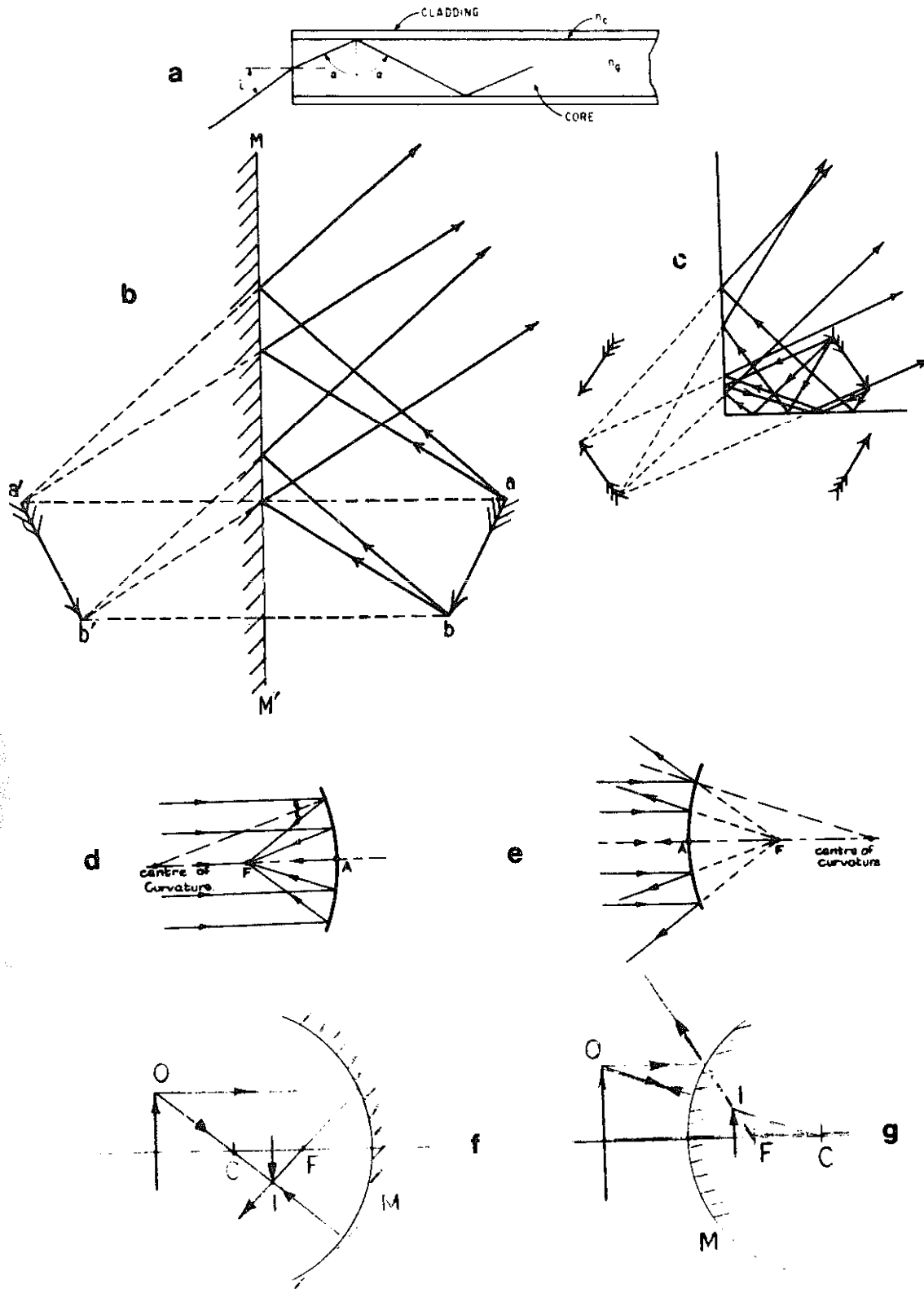

**B-Lenses. Prisms and Mirrors**

3--LENSES. Lens are limited portions of an optical medium by two spherical surfaces, the plane being considered a special case of a sphere with infinite radius.

**a--Thin lens;** double convex (converging) lens.

**b--Thin lens;** meniscus (converging) lens.

**c--Thin lens piano-convex (converging).**

**d--Thin lens double concave (diverging).**

**e--Thin lens;** meniscus, diverging (convex surface has shorter radius).

**f--Thin lens;** plano-concave lens (diverging).

**g--Image formation** of a thin lens. Thin line with arrows represents thin lens;  $F$  and  $F'$  are the principal focal points,  $ab$  the object and  $a'b'$  the image.

**h--Double convex thick lens.** Image formation construction same as under "g", except the principal planes have to be taken for measuring distances.

**j--Chromatic aberration,** numerically equal to the distance along the optical axis between image points by the light of two given wave lengths.

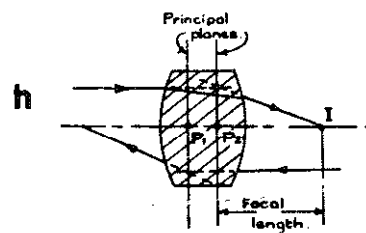
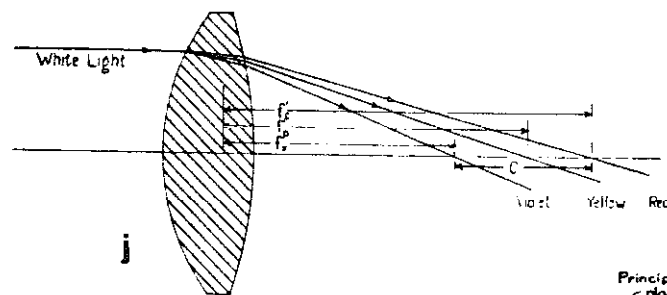
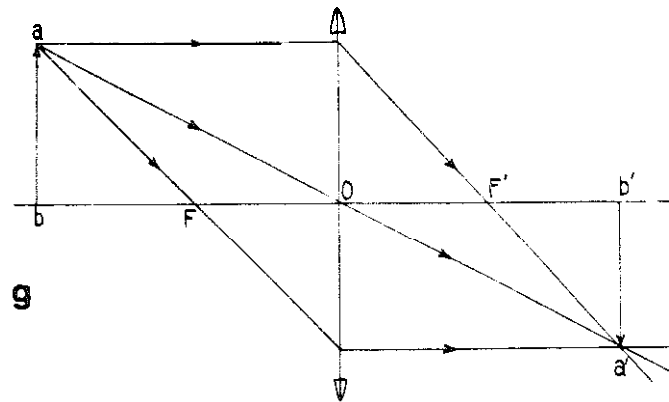
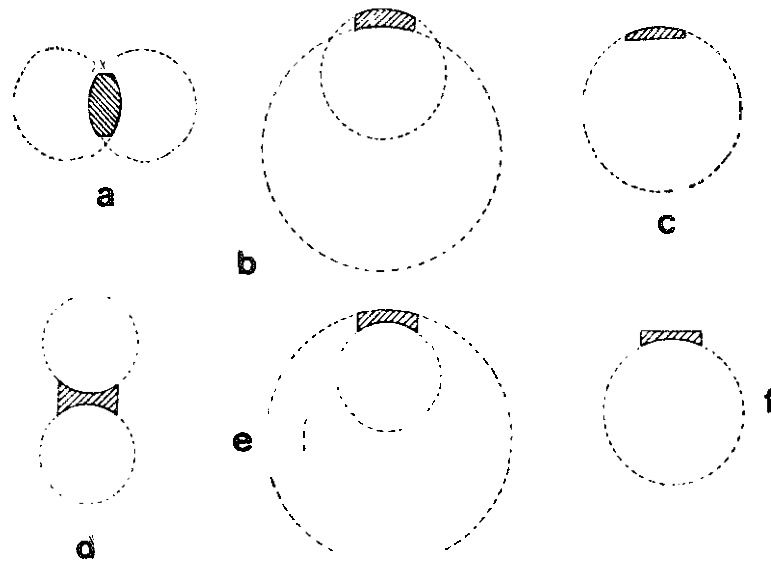

**B-Lenses, Prisms and Mirrors**

**3-LENSES (Cont)**

**&-Focal points** of diverging lenses.

**l-Human eye.**

**m-Myopia** (near-sightedness) corrected by lens.

**n-Hyperopia** (far-sightedness) corrected by lens.

**p-Contact lenses.**

**q - C o m a**, a defect caused by oblique rays not intersecting on the oblique axis.

**r - A s t i g m a t i s m** is an aberration where oblique rays intersect on the oblique axis, but not at the same point.

**s-Spherical aberration.** No plane with a sharp image exists.

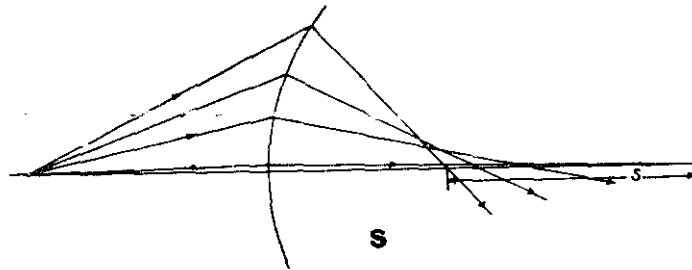
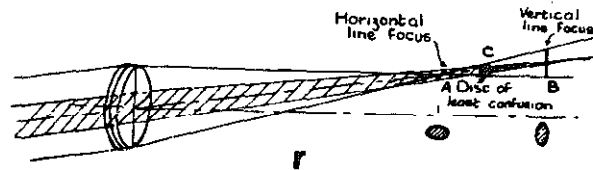
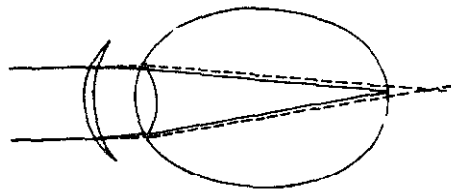
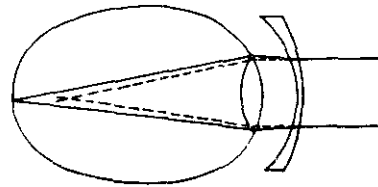
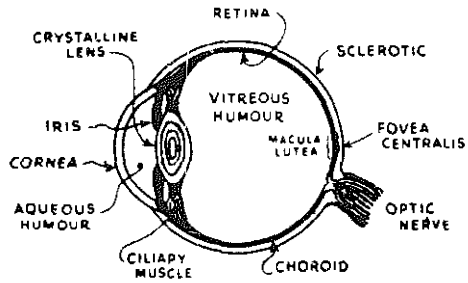
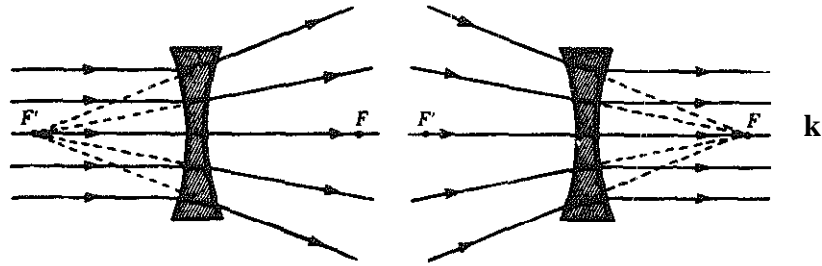

**B-Lenses, Prisms and Mirrors**

3-LENSES (Cont)

**t-Thick lens**, double convex. EFL, equivalent focal length (compared to thin lens); FFL, front focal length; BFL, back focal length.

**u-Pincushion distortion**, due to uneven magnification.

**v-Barrel distortion**, due to uneven magnification, also called positive distortion.

**w-Images act as objects.** O, real object; P, real image of O formed by lens #1; image P becomes object for lens #2; Lens 2 would form real image Q in absence of lens #2, but Q serves as virtual object for lens #3 with real image at R.

**x-Achromatic lens.** Used to correct chromatic aberration by using two kinds of glasses with different curvature and different indices of refraction.

**y-Achromatic lens**, broken type (air space between lenses), Dolland.

**z-Gauss type**, broken achromatic lens.

**aa-Barlow type** broken achromatic lens.

**ab-Field stop** between lenses, prevents vignetting effect.

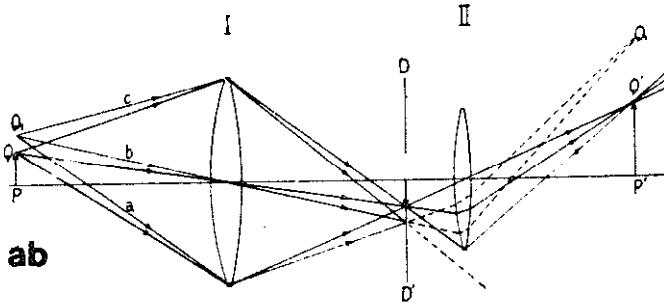
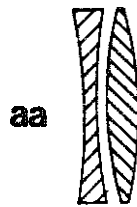
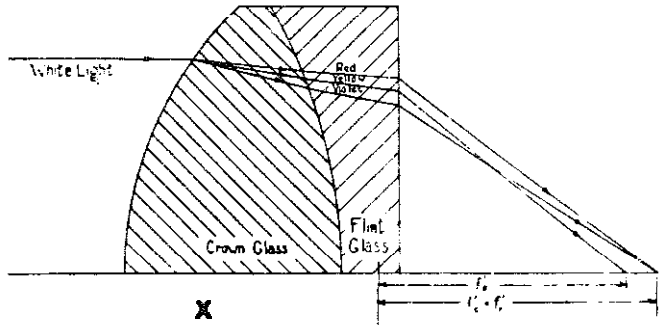
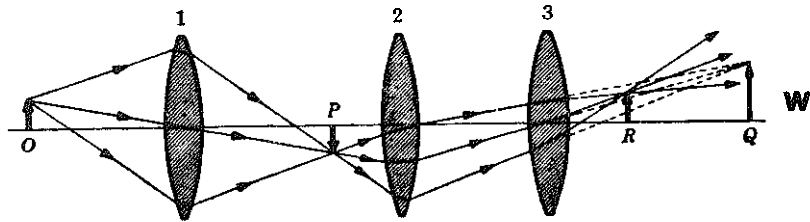
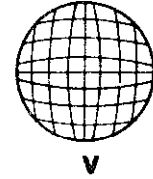
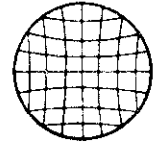
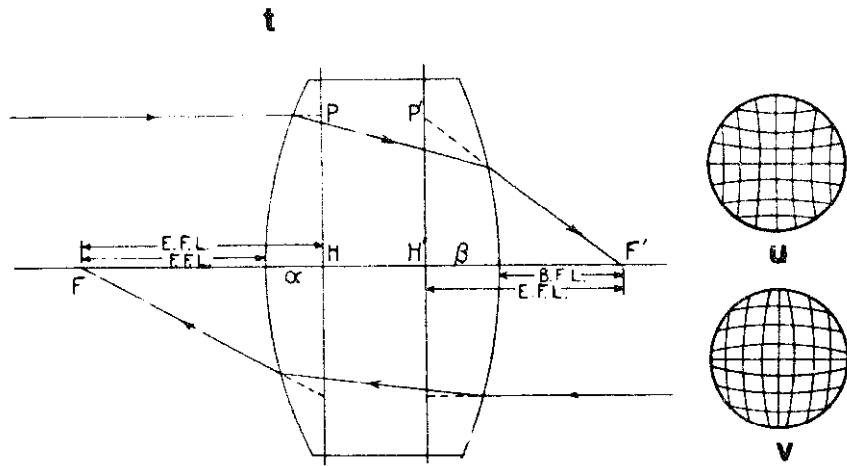

B-Lenses. Prisms and Mirrors

4-PRISMS. The term prism may **be applied** to any sort of solid refracting element whose sides are plane but not parallel.

a-Right angle total reflecting prism.

b-Penta prism. The two reflecting surfaces must be silvered.

c-Deviation prism. Deviation through a large range of possible angles.

d-Dispersion by a prism. If light source shines through a narrow slit, and lens forms an image of this illuminated slit, then a prism in its path forms an overlapping image of the slit, and builds up a band known as a spectrum.

e-Symmetrical ray; minimum deviation.

f-If  $I_2$  greater than the critical angle, the ray will be totally reflected at the second surface.

g-Basic figure used for ray tracing. (Geometrical Optics)



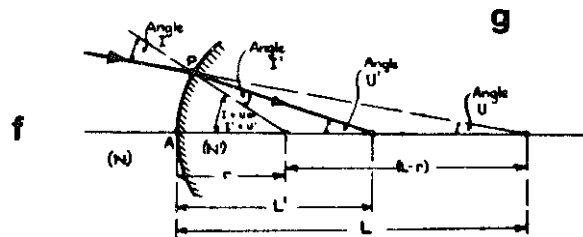
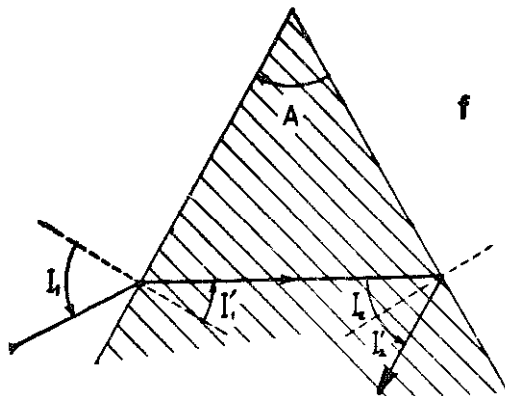
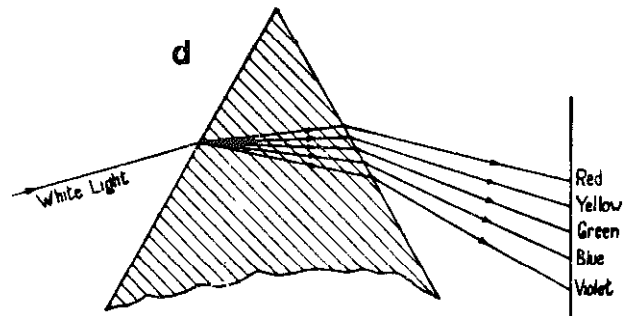
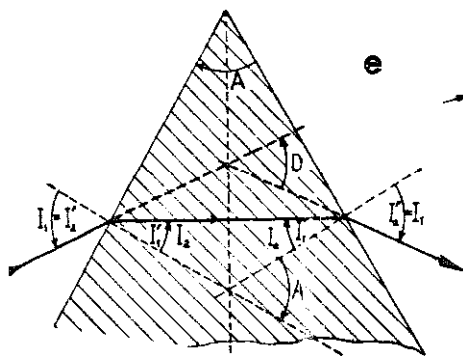
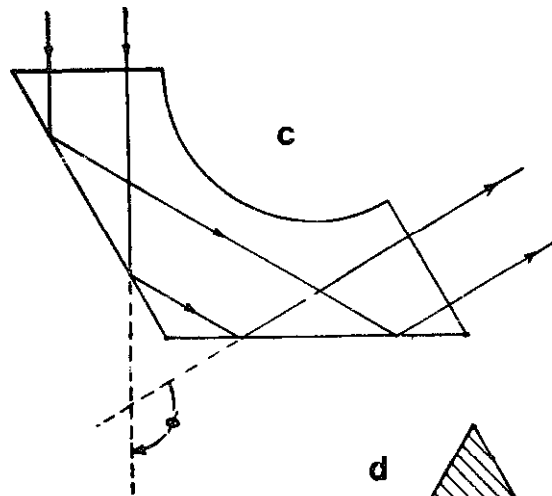
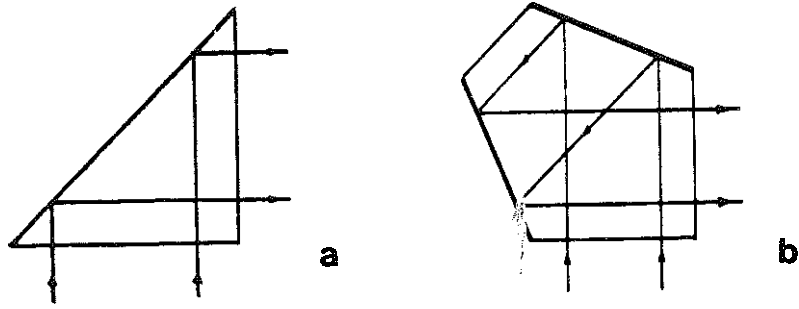

## C—Cameras and Projectors

### 1—CAMERA ELEMENTS

**a-Zeiss Tessar**, very well known anastigmat. It is formed of four lenses, with the two inner ones having lower indices of refraction than the other two.

**b—Cooke Triplet.**

**c-Petzval Objective.**

**d-Triple Protar.**

**e-Coding** symbols of glass materials for objectives a,b,c,d

**f—Iris diaphragm**, shown in open position. The iris controls the angular aperture for the cones of light and, therefore the light intensity on the image plane.





**g—Iris diaphragm** shown in a partially closed position. Its opening is adjusted by rotation of an outer ring. The ring has indicator to show focal ratio of camera opening.

**h-Common leaf-type shutter.** The shutter has usually five leaves which are being kept shut by a spring when not in use. The exposure time is set in fractions of a second, or time and bulb. Upon depressing the operating lever, the shutter opens for the selected interval.

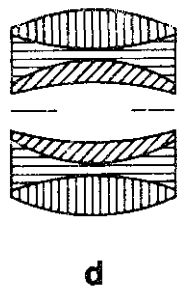
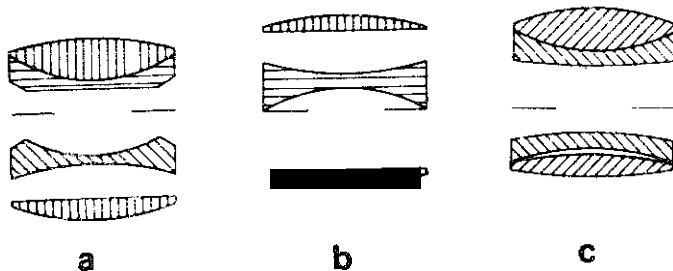
**j-Telescope type view finder.**

# CAMERA ELEMENTS



-  Crown
-  Flint
-  Dense Crown
-  Light Flint

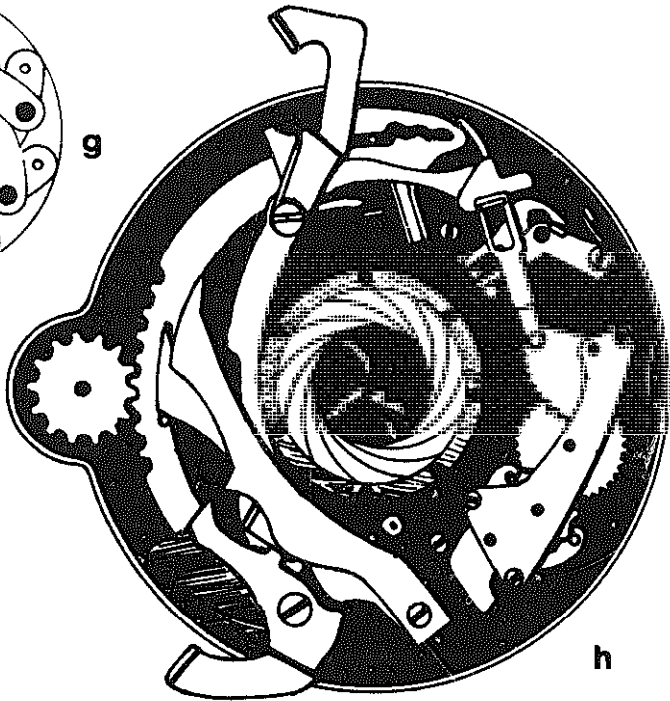
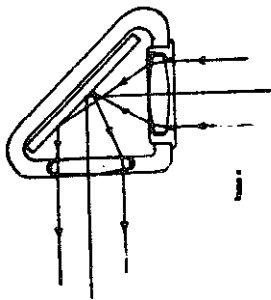
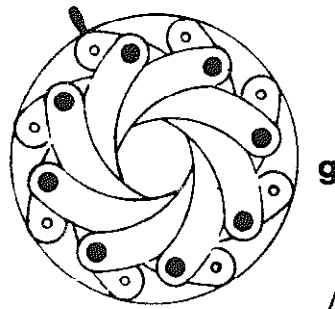
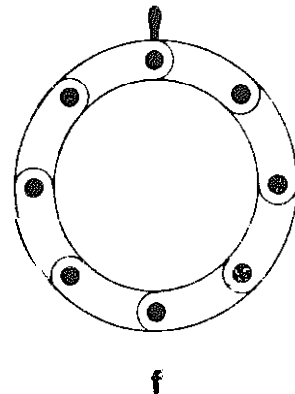

C-Cameras and Projectors

2-CAMERAS

a--Ground-glass type view finder.

b--Focusing for single lens reflex camera.

c--Exacta camera. Shown is a ray of light passing through the lens system and being reflected by the mirror through a pentaprism view finder, where some light is deflected to be measured by a CdS cell. Power is supplied by a button battery.

d--Movie Camera--Basic design.

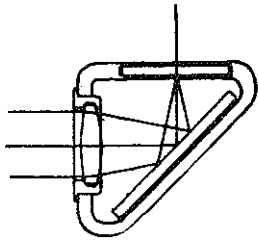

a

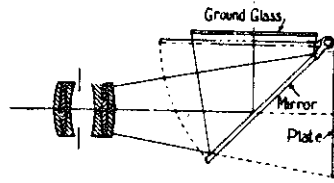

b

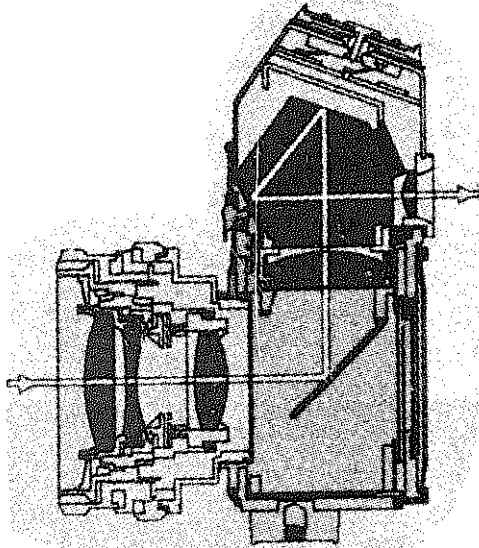

c

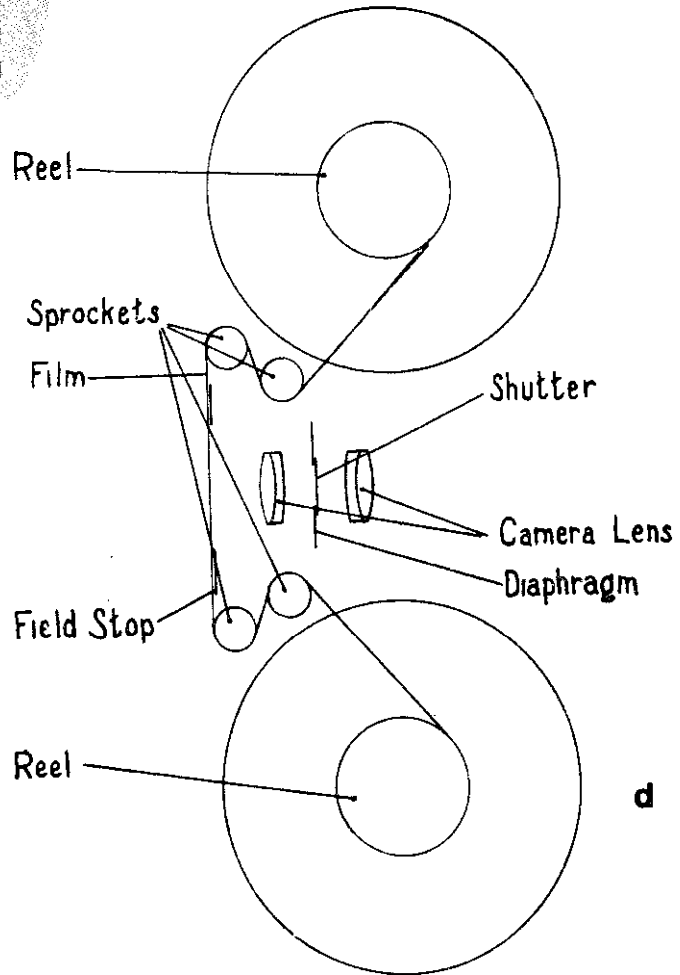

d

C-Cameras and Projectors

2-CAMERAS (Cont)

**e-Cannon Zoom 8** lens system and view finder; (Cannon Zoom Lens C-8). Fraction of entering light is deflected into viewer by means of a half mirrored prism. As shown the zooming elements are located centrally. Length of lens mount is not changed by zooming action. Split-image focusing.

**f-Bolex 155, super eight** moving picture camera, with 8.5 to 30mm Macrozoom lens. Covered by Paillard patents, it has 17 elements and 2 prisms. 1, fixed element; 2, focus compensating group; 3, zooming group; 4, beam splitter; 5, diaphragm; 6, roof prism; 7, film plane; 8, second beam splitter; 9, photo cell; 10, viewer system. Camera can focus down to one inch, and zoom from about seven inches to infinity.

**g-Single eight cartridge.** Feed and take up cartridge are in one plane, while the regular super eight is of co-axial design.

**h,j-Combined shutter and reflex mirror** rotates in a movie camera and alternately permits light to pass to the film, while the film is steady, and blocks the light to the film while film moves to the next frame. In this time interval (while blocking) the mirror on the shutter deflects the light to a second mirror which is part of the view finder optics.

# CAMERAS

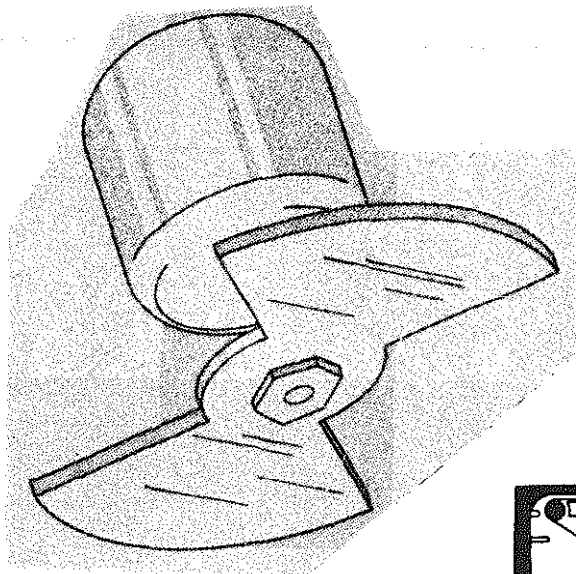

i

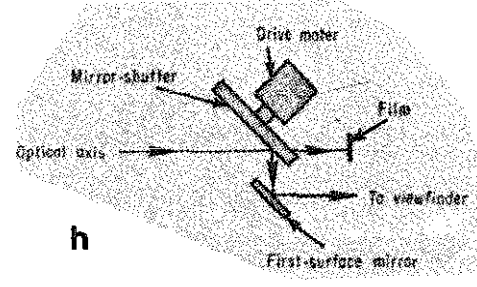

h

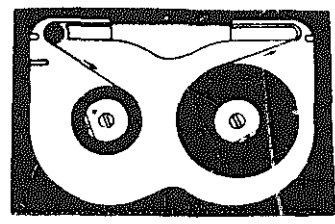

g

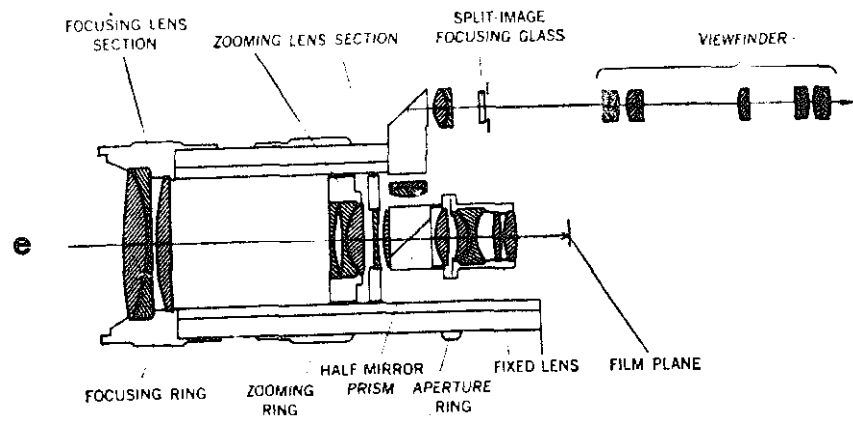

e

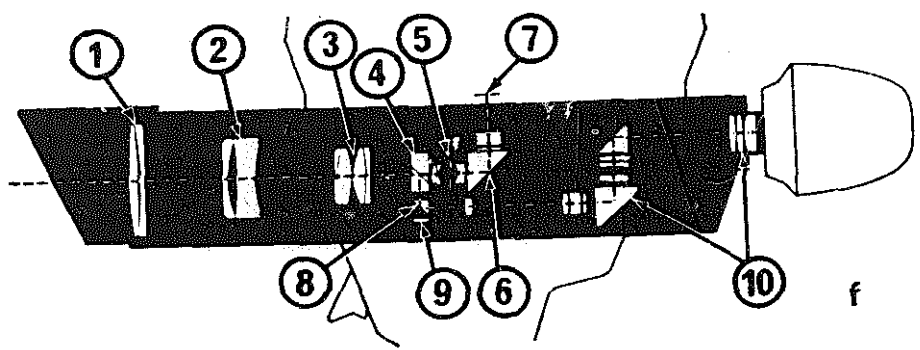

f

**C—Cameras and Projectors**

**3—PROJECTORS**

**a—Transparency**—Simple, crude, method of projecting transparencies.

**b—Transparency**—More efficient system than “a” since a large cone angle from sources passes through transparency.

**c—Transparency-Geometrical** study of “b” system.

**d—Transparency**—Another variation, imaging the source directly on the transparency.

**e—Opaque**—(episcopic) Projection of opaque material. Inherently inefficient, it requires very bright light sources mirror is required to correct lateral inversions of the image.

**f—Opaque**—(sphere) More efficient light gathering version of “e”.

**g—Searchlight-Parabolic** device designed to produce a powerful distant illumination.



# PROJECTORS

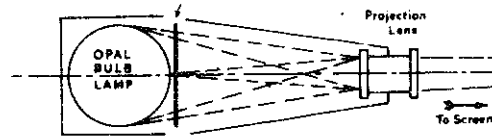

a

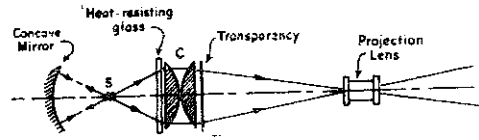

b

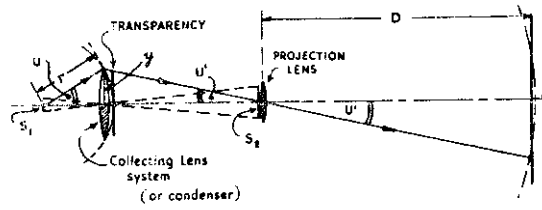

c

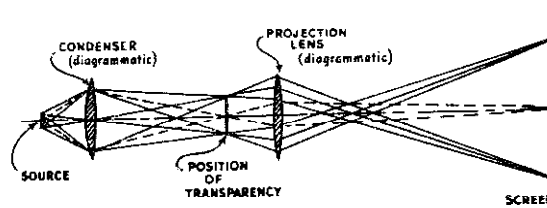

d

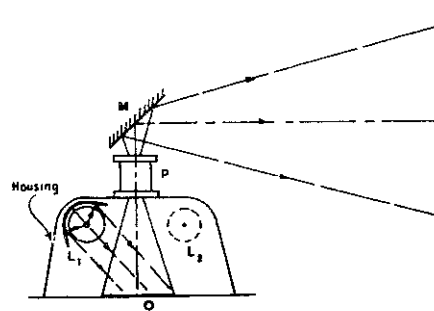

e

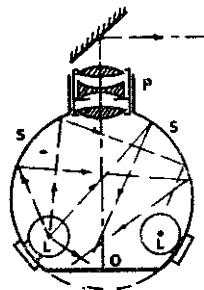

f

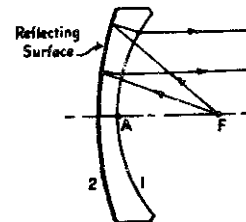

g

C—Cameras and Projectors

3—PROJECTORS (Cont)

**h—Headlamp**—The parabolic shape provides both a wide angle beam combined with a higher intensity middle section.

**i—Optical Comparator**—Projection system for checking mechanical parts such as screw threads, taps, dies etc. by projection onto screen.

**j—Microfilm Reader**—Projection system designed to project a 1-inch square area of microfilm.

**k—Lighthouse**—Combination of lens and mirrors designed to project beams of light in opposite directions.

**l—Polarized Light**—Projection of transparent objects using Nicol prisms.

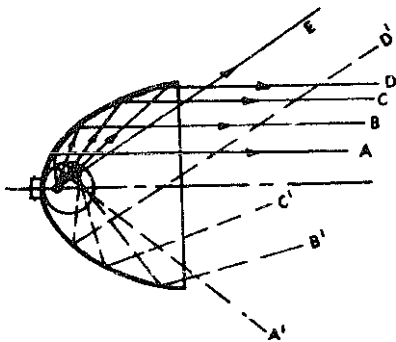

h

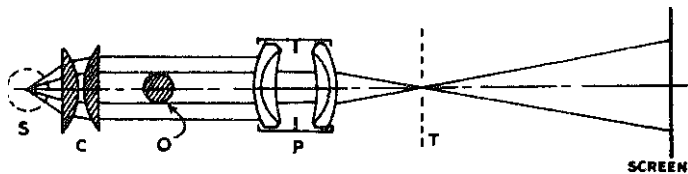

i

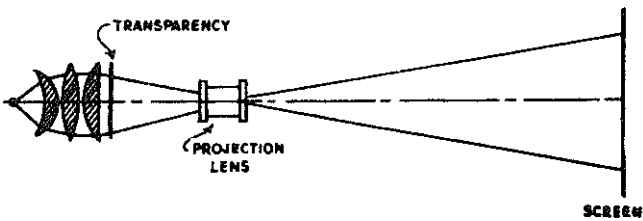

j

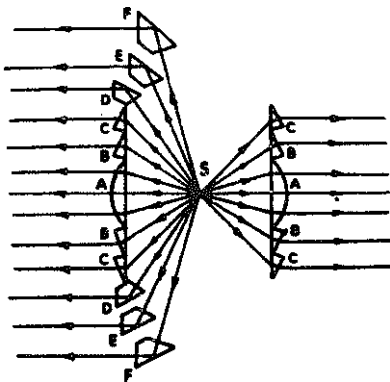

k

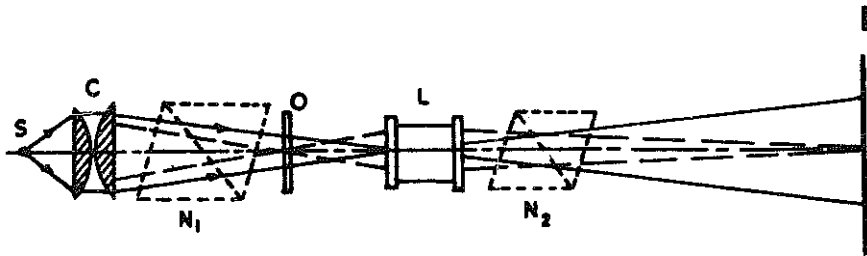

l

**D-Optical Instruments**

**I - TELESCOPES.** An optical system whose focal length is infinity constitutes a telescopic system. It is a combination of two optical systems, namely the objective and the eyepiece. They are placed so that the secondary principal focal point of one system coincides with the primary principal focal point of the other.

**a-Keplerian telescope.** The simplest possible type. No erection system, therefore inverted image.

**b-Galilean telescope.** Convergent lens of Keplerian telescope is replaced by a negative lens. Image formed by objective is virtual object for eyepiece. Gives an erect image, without erection system.

**c-Galilean field glass,** is built on principle of "b". This is also the optical system of the opera glass.

**d-Huygenian eyepiece.** Earliest form of compound eyepiece. The first lens is placed slightly inside the focal point of the objective, so that its object is virtual. First lens of eyepiece is called field lens, the second eyelens. Unit free of transverse chromatic aberration.

**e-Ramsden eyepiece.** Superior to "d" in spherical aberration and diastorsion, greater eye relief.

**f-Terrestrial eyepiece.** Actually it represents a combination of "d" and "e", with the Ramsden combination reversed. The eyepiece gets the rays from the objective, and forms a real image in the principal focus of the combination.

**g-Newtonian reflecting telescope.** Since the concave mirror forms a real image in front of the mirror a second mirror must be used to deflect image to where it can be observed.

**h-Cassegrainian form** of reflecting telescope. Built similar to Newtonian type, except that the ray is reflected back through a hole in the concave mirror.

**j-Gregorian form** of reflecting telescope. Same comment as under "h".

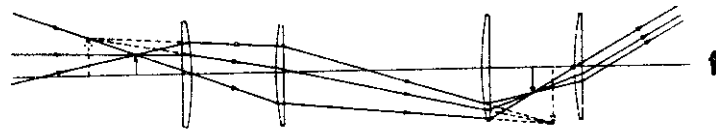
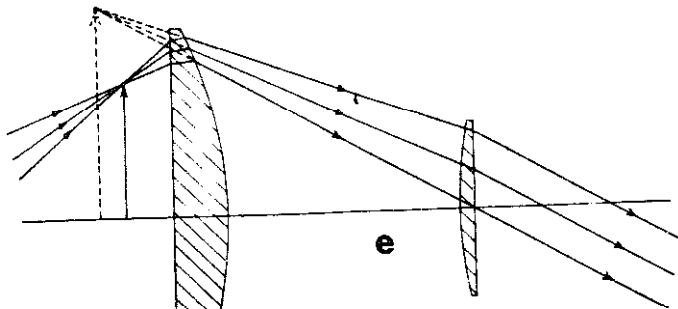
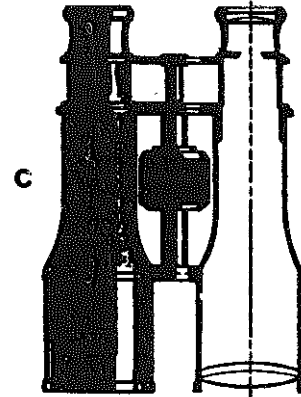
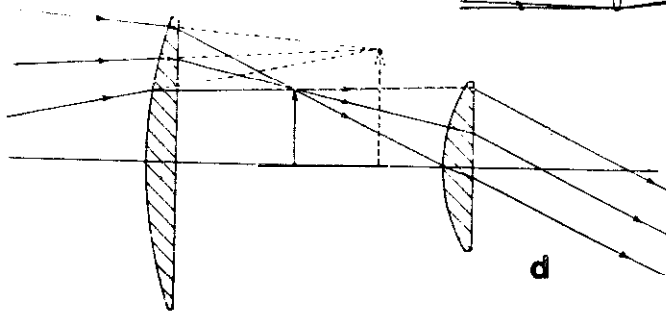
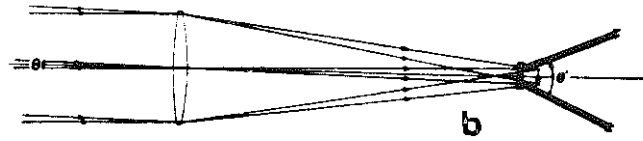
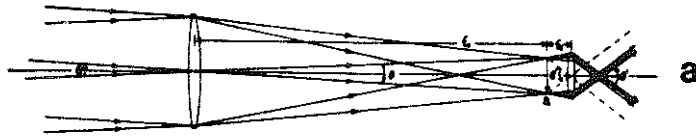

Parabolic Mirror

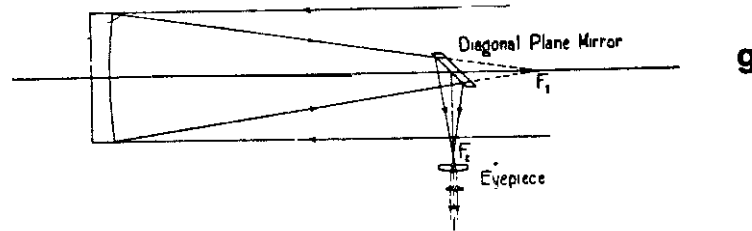

Diagonal Plane Mirror

$F_1$

Eyeiece

Parabolic Mirror

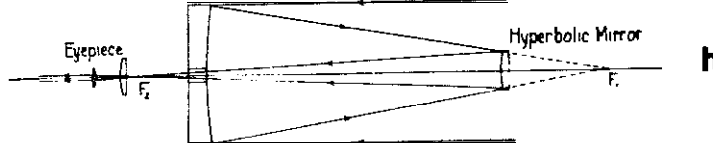

Eyeiece

$F_2$

Hyperbolic Mirror

$F_1$

Parabolic Mirror

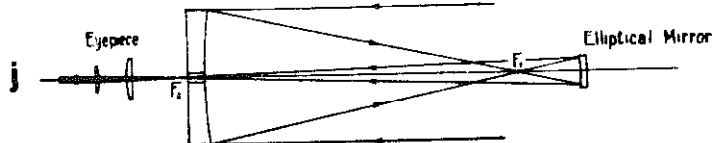

Eyeiece

$F_1$

Elliptical Mirror

$F_2$

### D-Optical Instruments

2-MICROSCOPES. A microscope is an instrument for viewing close objects.

**a-Magnifying glass.** When an object lies inside the principal focus of a converging lens, a virtual, erect and magnified image is produced.

**b-Compound microscope.** When object O is placed just outside of the front focal point of objective, it forms a real and enlarged image just within the first focal point of ocular, which in turn forms a virtual image of I at I'. All lenses are shown simplified.

**c,d,e-Common designs of microscope objectives.**

**f-Mounting of eyepiece** with spacer. Note: eyepieces are the same as for the telescope, in section 1.

**g-Condensers** are used to concentrate light on the specimen. They are achromatic, highly corrected, and contain up to six elements.

**h-Vertical illuminator.** For opaque specimens. Ring of light from a special condenser is made to travel down the tube outside the objective cell and is focused on the object through an annular lens surrounding the objective.

**j-Vertical illuminator.** Putting plane-parallel plate just above the rear lens of objective, makes objective act as condenser.

**k-Same as "j",** except prism replaces plane-parallel plate.

**I-Stereoscopic microscope.** Matched objectives give stereoscopic view. We actually have two microscopes here.

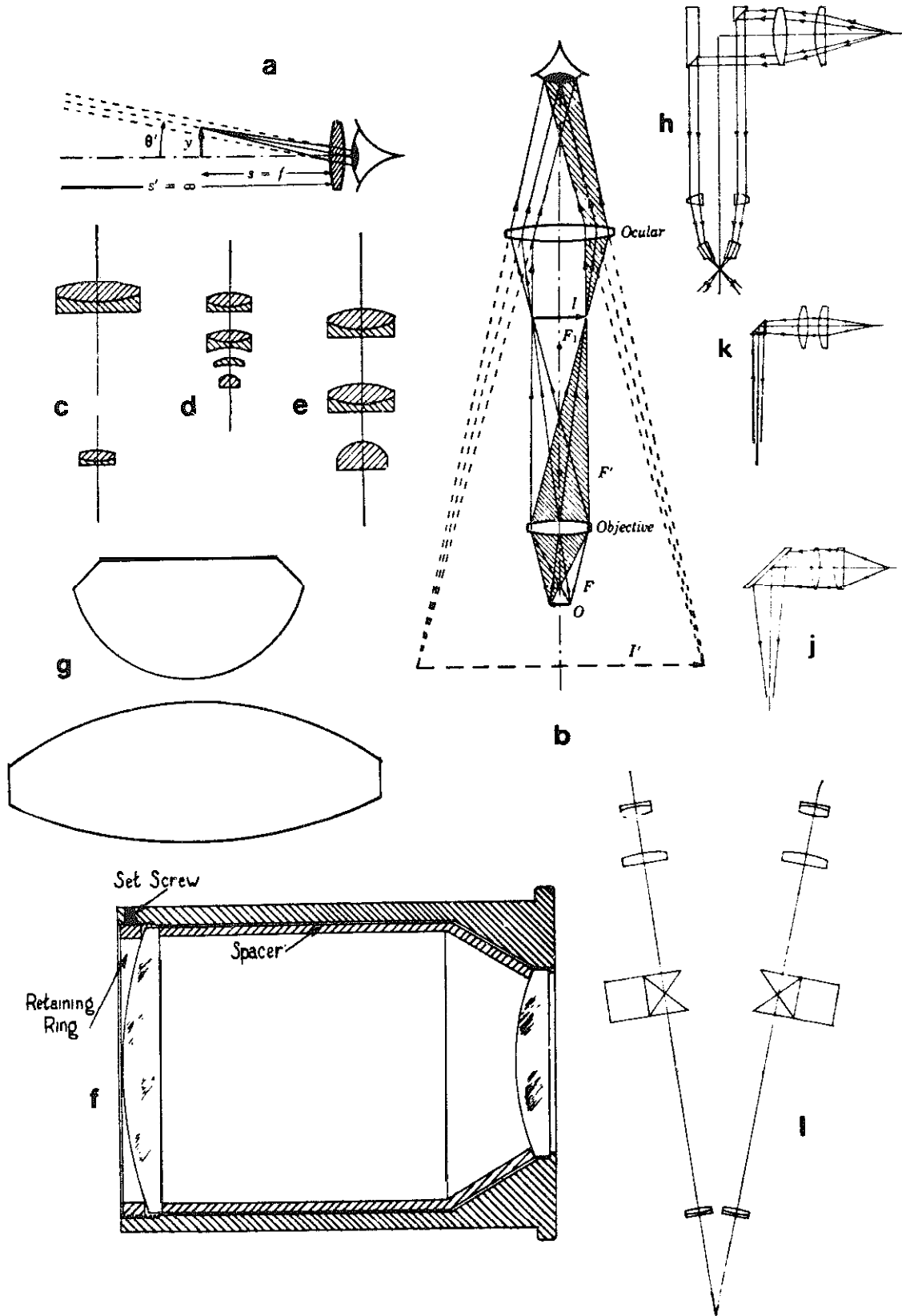

**D-Optical Instruments**

**3-MISCELLANEOUS.**

**a-Tank periscope.**

**b-Trench periscopes.**

**c-Submarine periscope.** While "a" and "b" are easy to understand, the submarine telescope is a complicated unit. A short focal length must be used to get a large field of view. These tubes are often 40 feet long, and therefore a succession of optical systems has to be used to bridge this distance.

**d-Coincidence type range finder.** We have two parallel telescopes and combine the two fields of view into a single field. A given object in one field will be displaced laterally in the other field, depending on distance between the two telescopes, the focal length of the objectives, and the range. Adding a prism in each system, one fixed, the other movable, coincidence can only be achieved by a change in position of a movable wedge, which is coupled to a scale or lens.

**e-Prism binoculars.** The length of the instrument is reduced by the full length of the optical path through the prisms, plus twice the separation of the hypotenuse faces of the prisms.

**f-Direct vision spectroscope:** It consists of a slit and a series of prisms, at least three. Usually a collimating lens is added in front of the prism combination. Since each chemical element has a characteristic spectrum, bright or dark line, emission or absorption, light from an unknown substance can be determined.

**g-Prism spectroscope,** consisting of adjustable slit, collimator, prism and telescope, with Ramsden eyepiece.



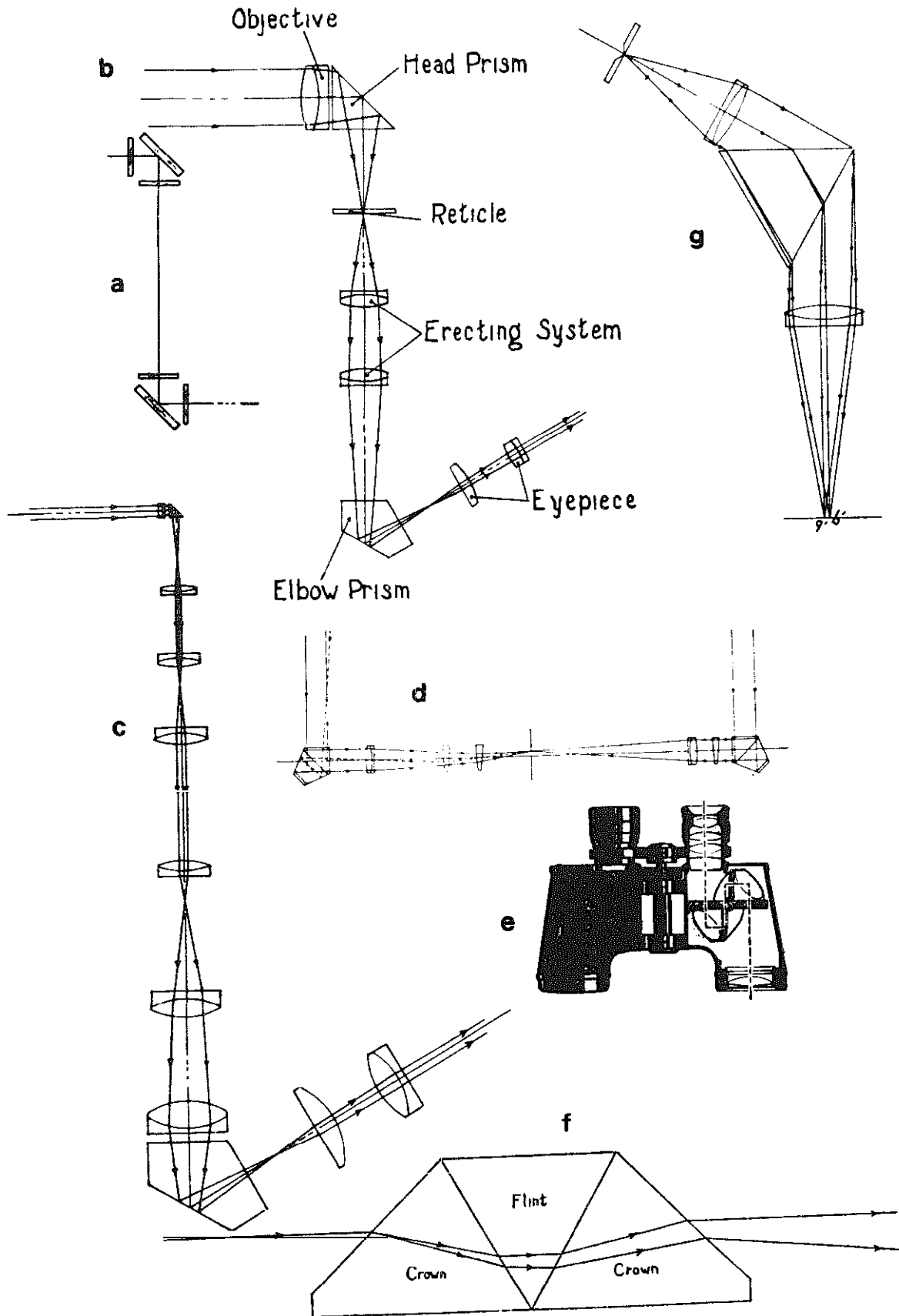

## **IV FLUID TECHNOLOGY**

**A—Hydraulic Elements**

**1—PISTON AND CYLINDERS.** These convert the flow of pressurized fluid into a push or pull of its piston rod.

**a—Typical cushioned cylinder.** (a) honed cylinder; (b) cushion plunger; (c) cushion chamber; (d) inlet and outlet ports; (e, f) cushion check for quick return. This cylinder works in a double acting circuit.

**b—Simplified drawing of single acting, spring return cylinder.**

**c—Simplified drawing of double acting cylinder with double-end rod.**

**d—Ram.** A single acting cylinder with rod closely fitting I.D. of cylinder.

**e—Telescoping cylinder.**

**f—Bleeders** must be located on top.

**g—Construction of cylinder: tie-rod.**

**h—Construction of cylinder: threaded head.**

**j, k—Flange mounting of cylinder.**

**l, m—Clevis mounting of cylinder.**

**n—U-cup packing.**

**p—Cross-section through U-cup packing.**

**q—V-packing.**

**r—Flange packing.**

**s—Q-ring.**

**t—Double acting hydraulic cylinder with piston ring seal construction.**  
(Miller, Fluid Power Div., Flick-Reedy Corp.)

**PISTON & CYLINDERS**

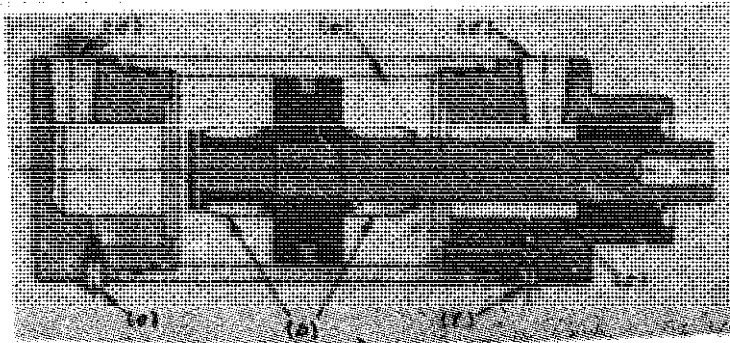

a

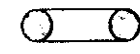
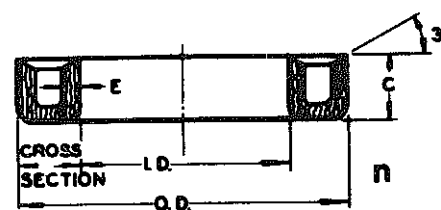
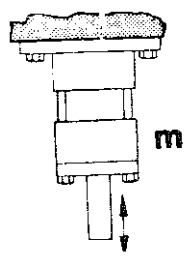
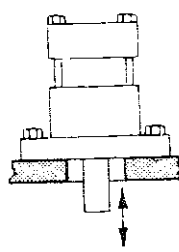
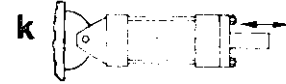
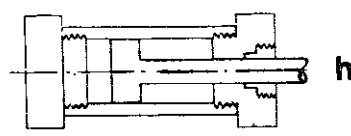
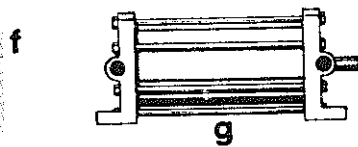
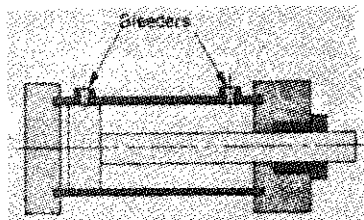
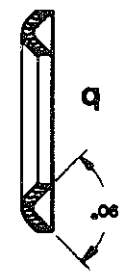
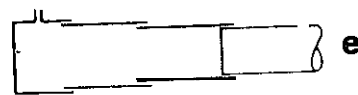
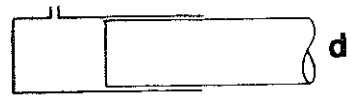
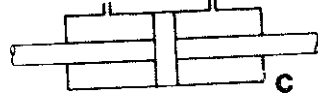
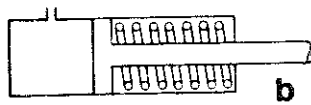
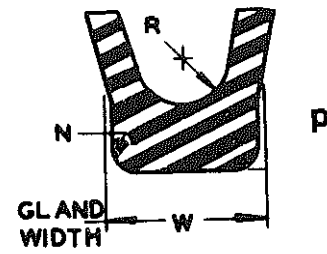

s

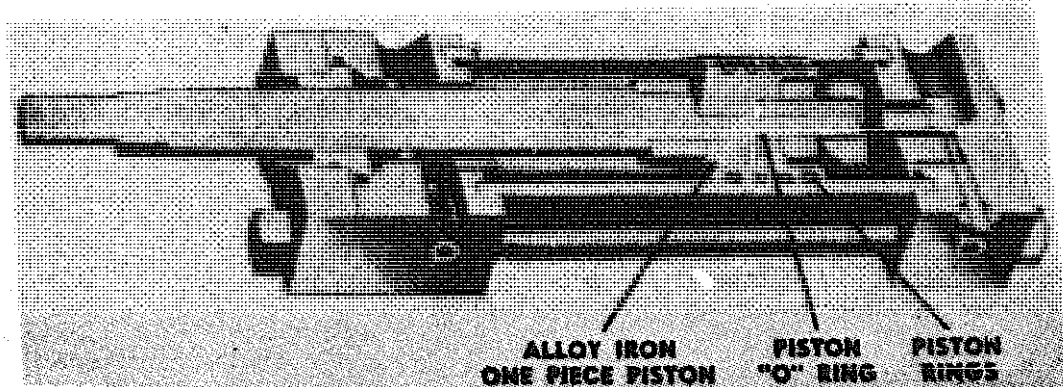

t

**ALLOY IRON ONE PIECE PISTON      PISTON "O" RING      PISTON RINGS**

### A-Hydraulic Elements

2-RESERVOIRS. Reservoirs are fluid storage for an oil-hydraulic system. A rule of thumb is that the reservoir size should be at least twice the delivery capacity of the pump in gallons per minute. The capacity must be enough so that the returning oil cannot cause the reservoir oil to go over a given temperature limit, usually 130 to 150° depending on the oil used.

a-Reservoir constructed of welded steel plates. Note baffle to separate return lines from pump inlet line.

b-Reservoir above pump provides for good suction conditions for pump, and minimizes cavitation problems.

c-Location of pump above reservoir. Short suction line.

d-Accessory for reservoir. Fluid level sight gage with thermometer. (Lenz Fluid Power Accessories, Inc.)

e-Accessory. Fluid level gage indicating high and low. (Lenz Fluid Power Accessories, Inc.)

f--Accessory; breather filter; act as ventilators to provide free flow of filtered air. (Lenz Fluid Power Accessories, Inc.)

g-Accessory. Side mounting filler, breather cap, air filter and strainer assembly. (Lenz Fluid Power Accessories, Inc.)

h-Partially disassembled view of standard power package. (Vickers Div., Sperry Rand Corp.)

# RESERVOIRS

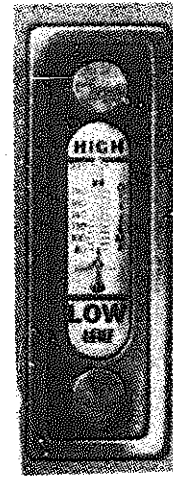
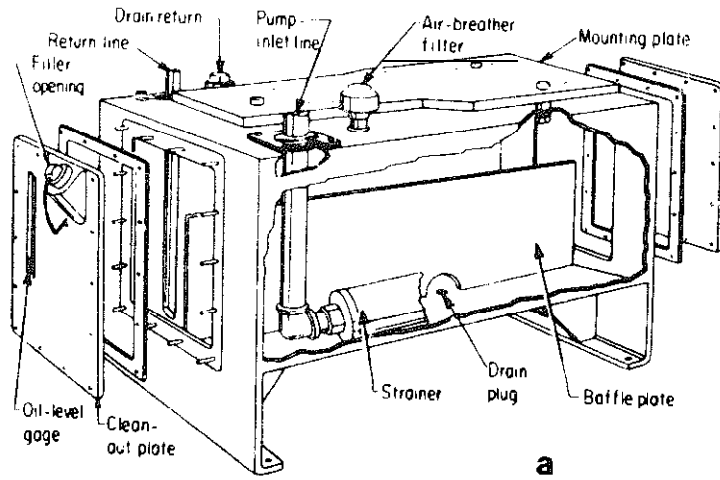

d

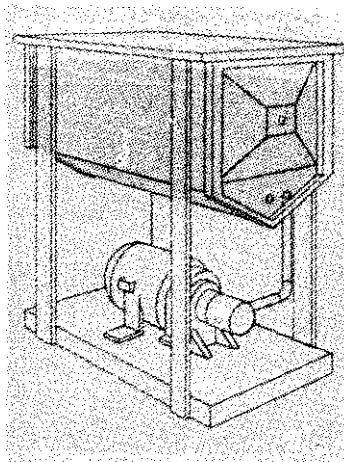

b

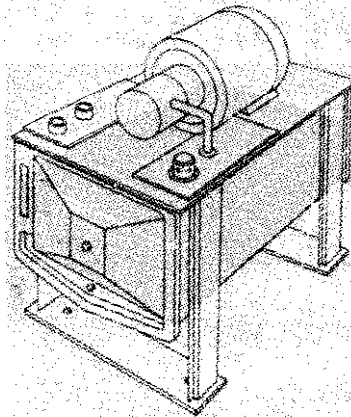

c

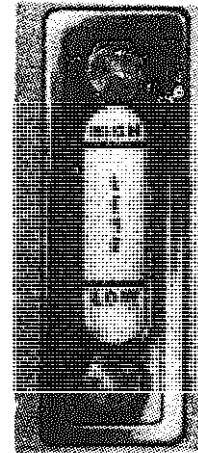

e

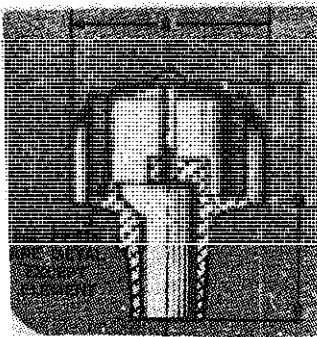

f

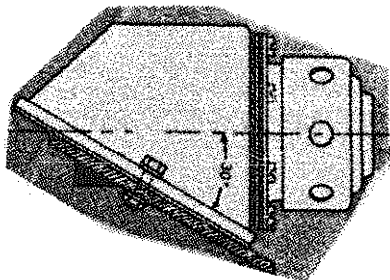

g

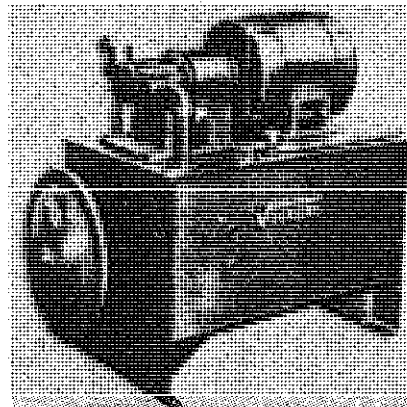

h

### A-Hydraulic Elements

**3-BOOSTERS AND HEAT EXCHANGERS.** Boosters are used to intensify pressures. It is obtained by using different effective areas. Heat exchangers are used to keep the temperature of the oil at a proper level.

**a--Reciprocating intensifier** with mechanical shift. In the position shown, low pressure is pushing the large piston to the right, discharging the fluid ahead of the piston to the tank. Intensified pressure closes two of the four shown check valves, (shown on top). Near the end of the stroke, main piston head shifts a spool, and direction of travel of piston is reversed. (Racine Hydraulics, Inc.)

**b--Simpler type of booster** developed by the same company as "a".

**c-Single acting continuous booster.** With air pressure on, piston is forced down, and ram forces oil through check valve. Air is then directed to other side of piston, and piston retreats, drawing in a new supply of oil, etc. (S.C. Hydraulic Engineering Corp.)

**d--The plate-type heat exchanger** has finned tubes. Here the hydraulic fluid flows through the tubes and the heating or cooling medium flows around it.

**e-Shell and tube heat exchanger.** The preferred type of heat exchanger if water is the cooling medium. Oil usually flows around the tubes, while water flows inside of the tubes.

**f-Air-to-oil coolers** use finned tubes with a fan OF blower to force air around the tube sections.

BOOSTERS

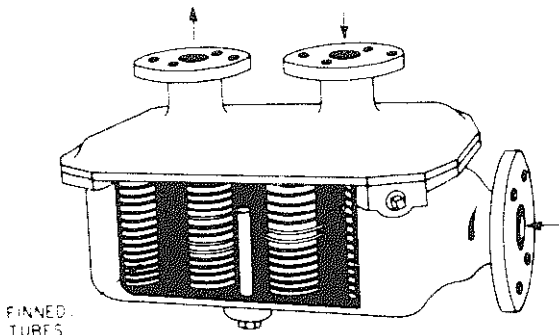
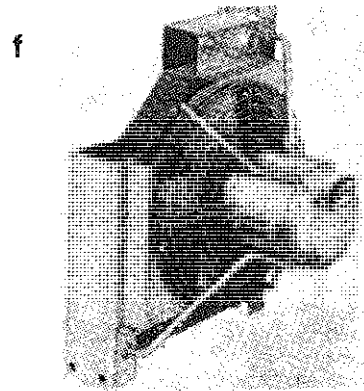
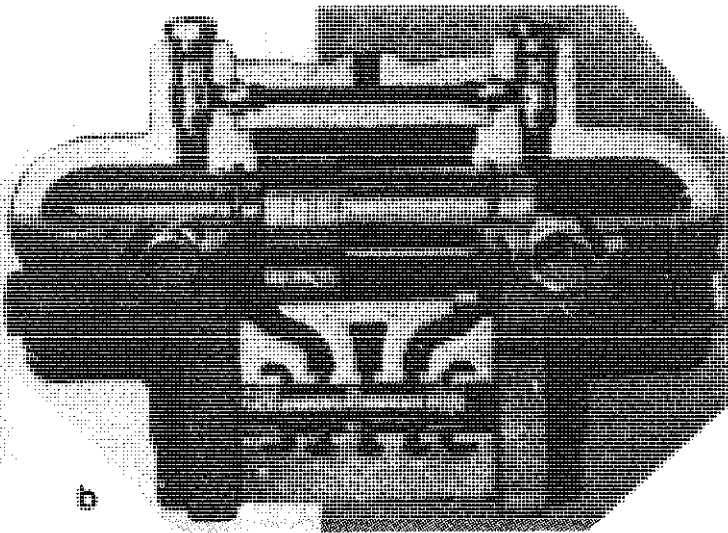
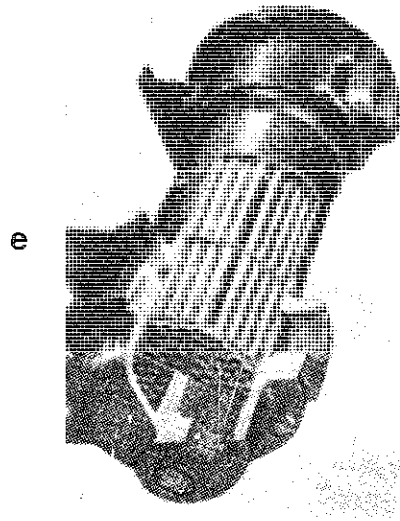
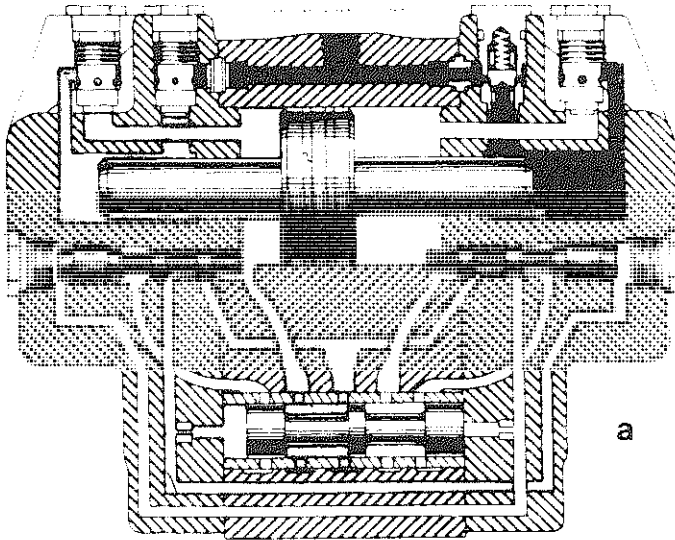

d

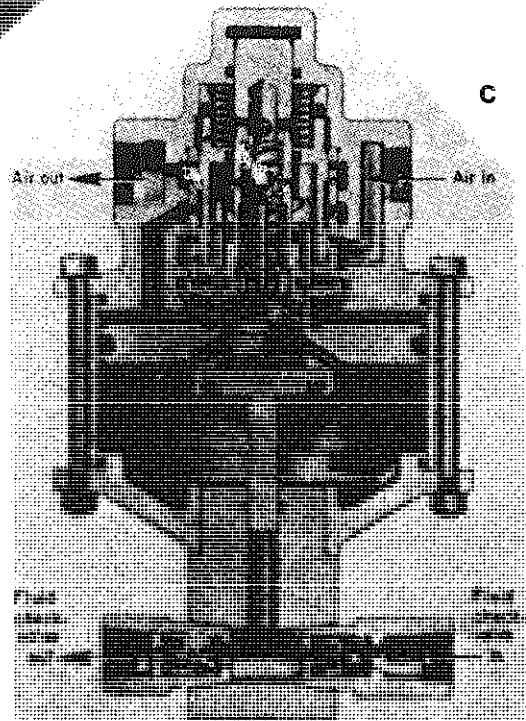



**A—Hydraulic Elements**

**4—ACCUMULATORS.** These are fluid pressure storage chambers. The accumulator stores the potential energy of a fluid under pressure returning it to the system if system requires momentarily more than the pump output. It also can act as a shock absorber.

**a—Separator-bag type accumulator.** Consists of heavy walled cylinder and rubber bag. The rubber tube is sealed at the end caps. Gas is precharged through a valve in the outer cylinder. (Greer Hydraulics, Inc.)

**b—Normal position of “a”.**

**c—Injecting cushion oil in “a”.**

**d—Preloading with dry nitrogen or air.**

**e—Charging from pump; oil-air ratio 3:1.**

**f—Same as “e”, except oil-air ratio 5:1.**

**g—Discharging oil to system.**

**h—Piston type accumulator.**

**j—Diaphragm type aircraft accumulator.**

**k—Floating piston type accumulator.**

ACCUMULATORS

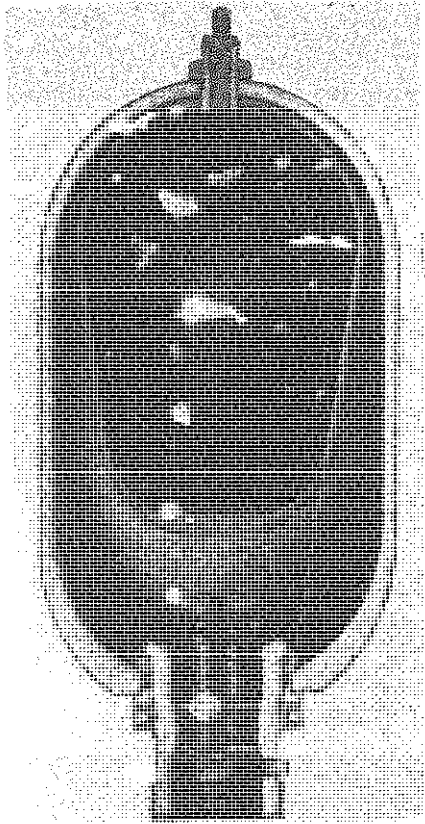

a

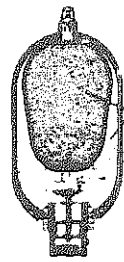

b

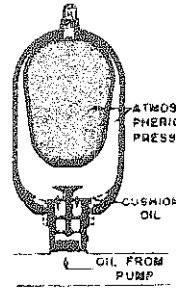

c

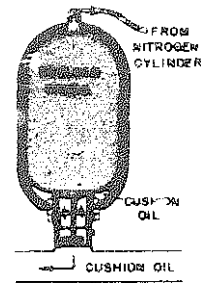

d

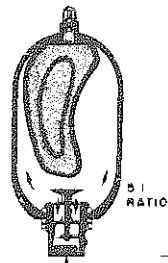

f

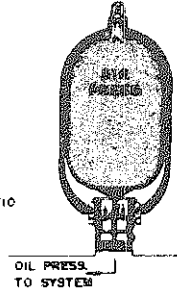

g

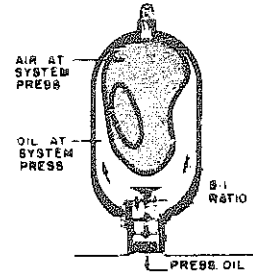

e

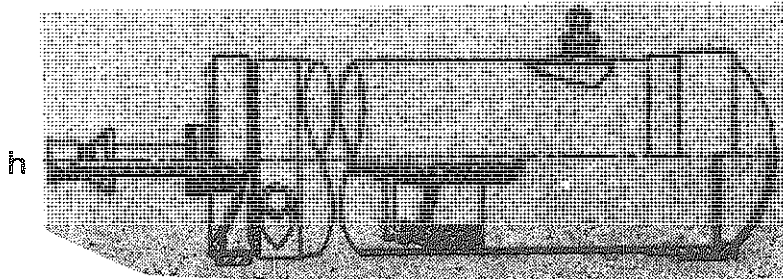

h

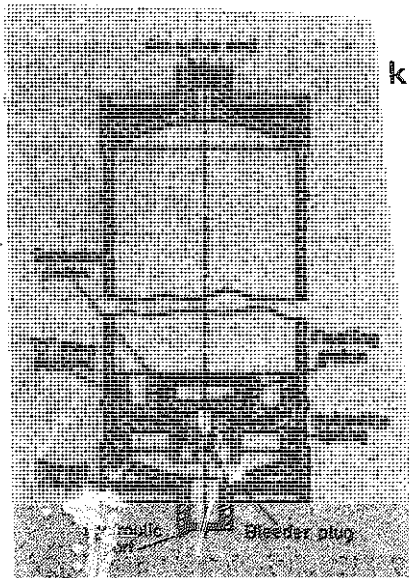

k

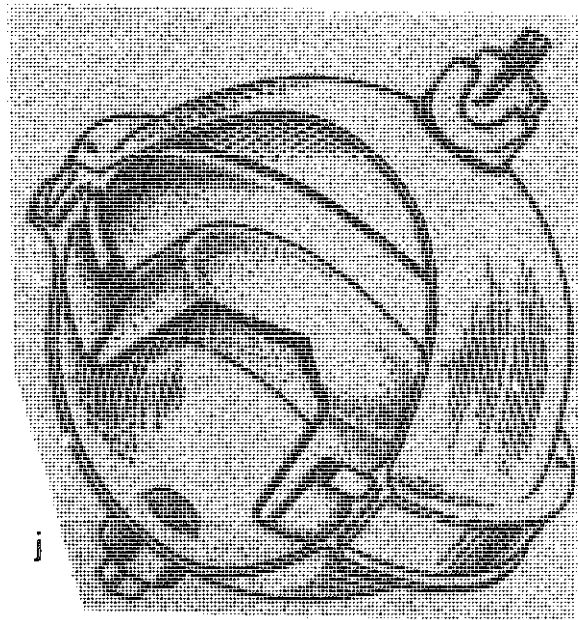

j

### A—Hydraulic Elements

5—**FILTERS** are used to remove contaminants from the fluid to protect components which otherwise might be damaged from them. Filter ratings are in microns; one micron equals 0.000039 inches.

**a-Square-weave wire mesh screen filter.** Fluid enters through the side and exits through the center.

**b—Element of sintered metal-powder filter.** Fluid enters through side and exits through center.

**c-Paper filter.**

**d—Felt filter element.**

**e—Single bolt cartridge type filter** with relief valve permits rapid change of cartridge. The spring holds the cartridge in position.

**f—Ribbon type element.** Flow through filter element shown. Contaminant collects on outside of element.

**g-Pleated type filter arrangement of cartridge.** Contaminant collects on outside.

# FILTERS

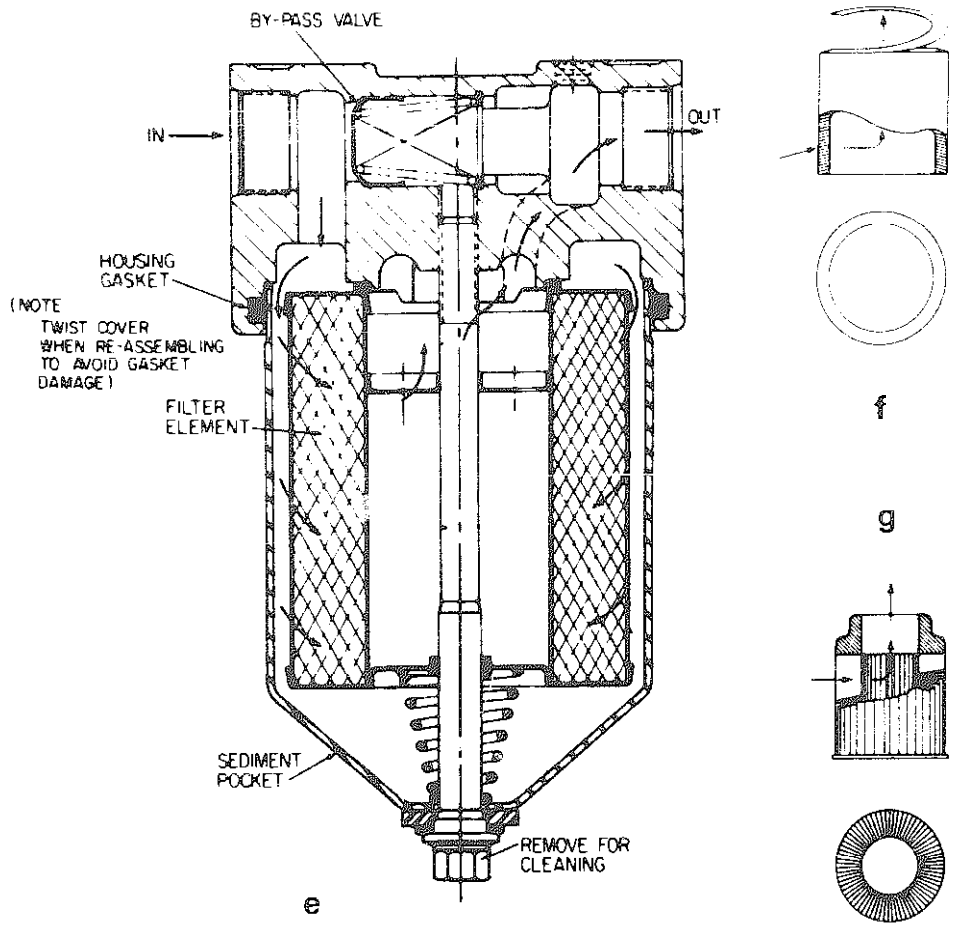
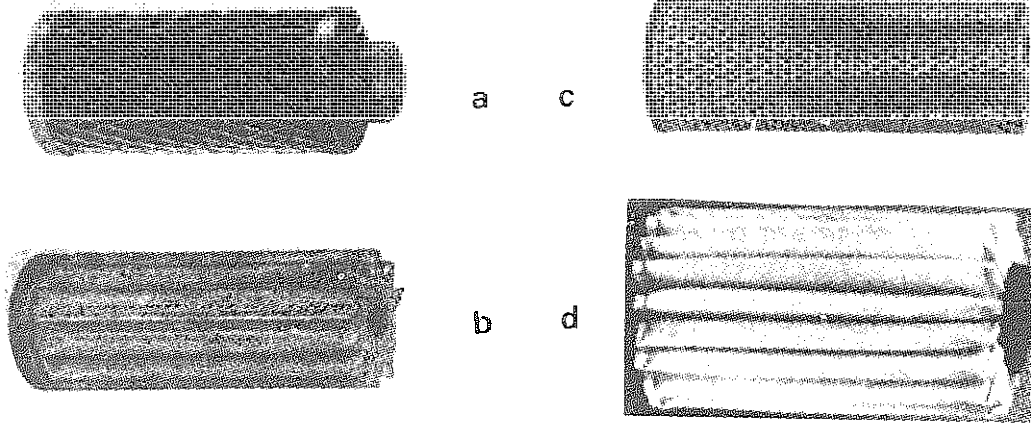

B—Pumps

1—EARLY TYPE ROTARY PUMPS.

They are used to pressurize fluids so work may be performed. Most of these units are only of historic interest, but they form the basis for the modern machines.

a—Pappenheim rotary pump.

b—Cochrane rotary pump.

c—Rotary pump or motor; can be run in either direction.

d—Cary rotary pump.

e—Pattison rotary pump.

f—Ramelli rotary pump.

g—Emery rotary pump.

h—Heppel rotary pump.

j—Knott rotary pump.

k—Repsol rotary pump.

l—Holley rotary pump.

m—Quimby screw pump.

n—Root's blower and pump.

o—Root's blower.

p—Mackenzie's blower; it may have one, two or three vanes.

q—Gould's rotary pump.

r—Greindl rotary pump.

s—Mellory rotary pump; consists of a rocking vane or partition with packing device which accommodates itself to the revolving oval piston.

t—Rotary motor or pump; it has four rolling pistons.

u—Star-wheel-gear rotary pump or motor.

v—Hasafan eccentric revolving piston.

w—Two hinged vanes and eccentric rotor or piston.

EARLY TYPE ROTARY PUMPS

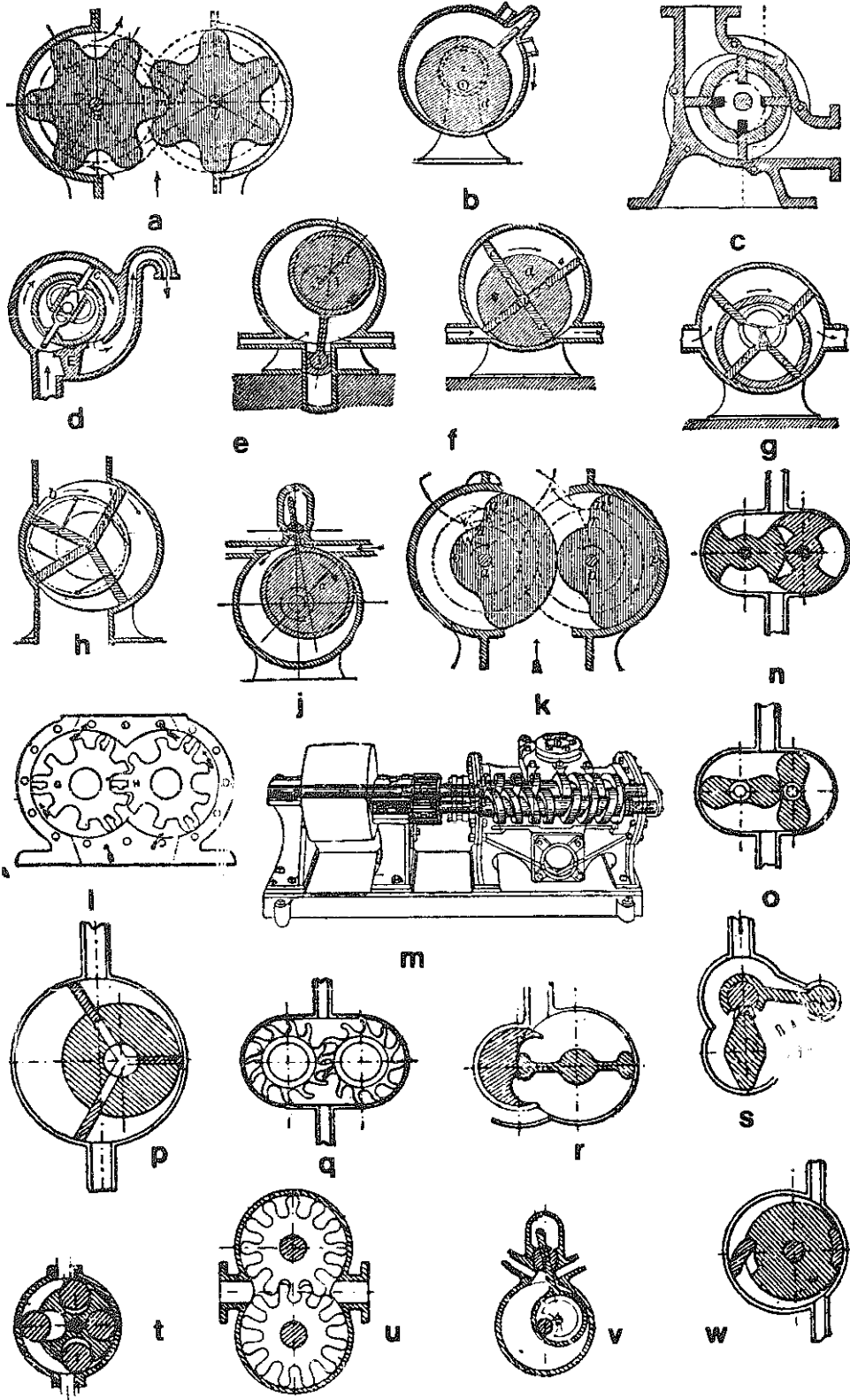

## B-Pumps

**2-GEAR AND VANE PUMPS.** Pumps are used to pressurize fluids so work may be performed.

**a-Rotary spur gear pump.** Two mated gears, closely fitting the casing, turn. One gear is the driver, the other gear, the follower, is driven by the driver.

**b-Rotary spur gear pump.** Same as "a", but balanced type.

**c-Herringbone gear pump.** Picture shows power input shaft to driver.

**d-Internal gear pump.** The gear-like rotor rotates concentrically in the casing, while the drive gear G is mounted eccentrically. The crescent C shown, separates suction side from discharge side. While rotating, note that the gear teeth move away from the rotor, then toward it, thereby creating suction on one side and pressure on the other side.

**e, f, g-Gerotor pump;** a special form of internal-gear pump; an inner gear is keyed to, and rotates with, the driving shaft; an outer gear of internal type is driven by the inner gear and is free to rotate with a snug fit in a recess in one end of the housing; the teeth of the two gears are specially shaped so that the tops of all teeth of the inner gear are always in sliding contact with the teeth of the outer gear.

**h-Blackmer swinging-vane-type rotary pump;** made in ten sizes from 10 to 750 gpm; operating pressures are from 5-inch mercury gage vacuum to about 60 psi.

**i-Same as "d".**

**j-Relief valve design of "h".**

**k-Vickers vane pump;** a constant-discharge pump in which radial vanes produce the pumping action; the vanes are free to slide in and out of a rotating hub and so maintain contact with the outer ring; oilways from the high-pressure side of the pump to the spaces behind the vanes assure that this contact is maintained at all times.

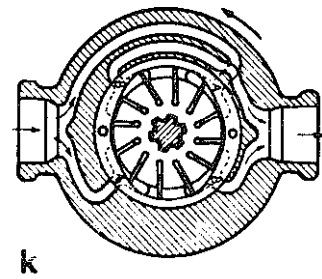
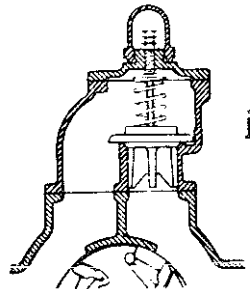
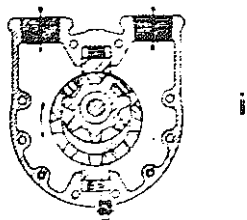
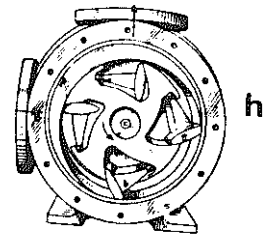
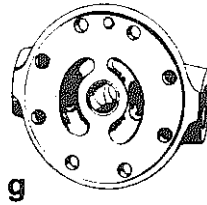
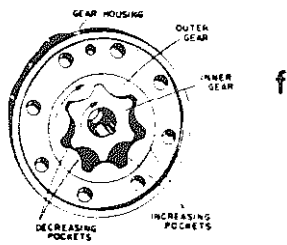
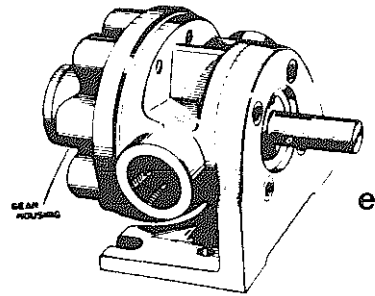
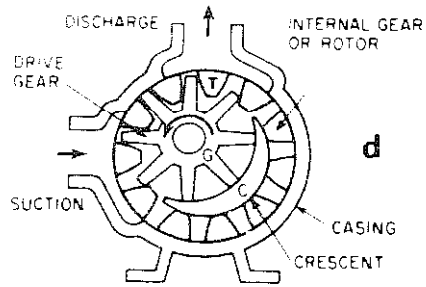
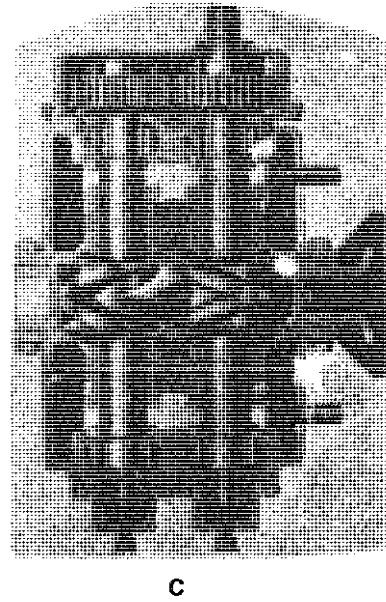
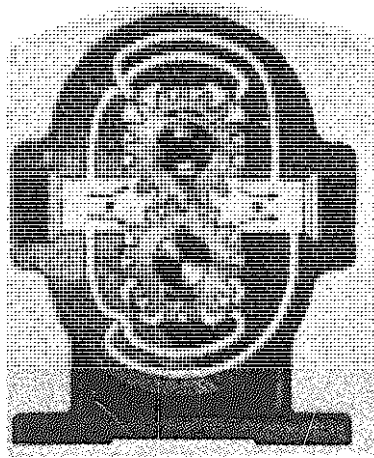
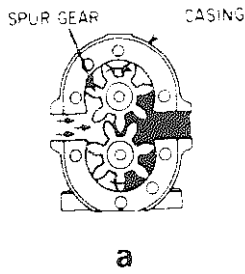



## B—Pumps

### 3—PISTON PUMPS.

**a—Valve plate axial piston pump.** The drive shaft supports ball bearing end of wobble plate in an eccentric socket; wobble plate drives pistons without revolving.

**b—Bent axis, valve plate, axial piston pump.** The angle between the two-sectioned housing determines the piston travel. During one half of a revolution oil is drawn in, and forced out during the other half.

**c—Typical cylinder block of an axial hydraulic pump.**

**d—Typical piston elements for axial hydraulic pump.**

**e—Axial piston pump, connecting rod type.** Works like “b” except that the angle is adjustable by hand-wheel.

**f—Same as “g”,** except angle is adjusted by servo control.

**g—Checkvalve radial piston pump.** Radial pistons are driven by eccentrics.

**h—Radial piston, variable displacement pump.** The variable displacement is obtained by positioning the slide block eccentric to the cylinder.

# PISTON PUMPS

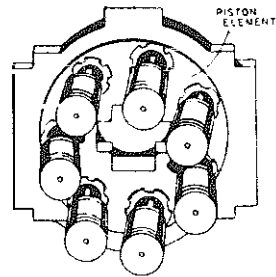
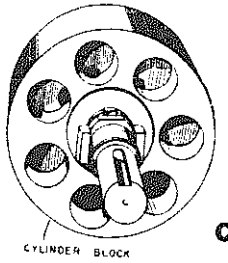
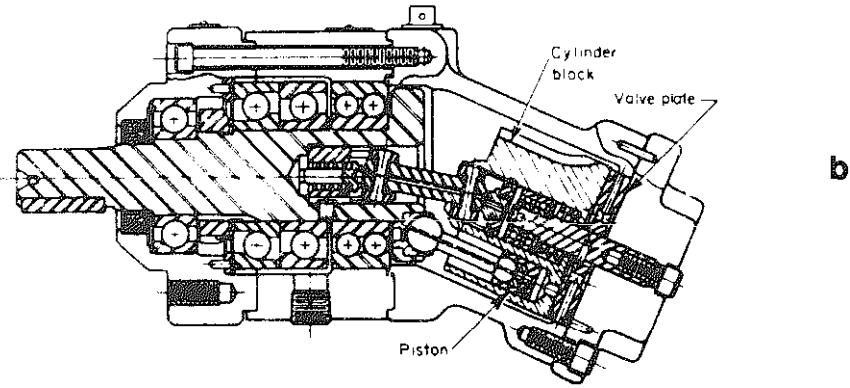
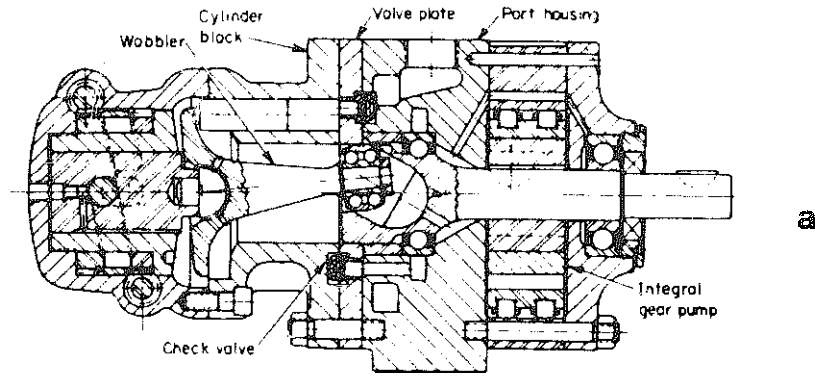

d

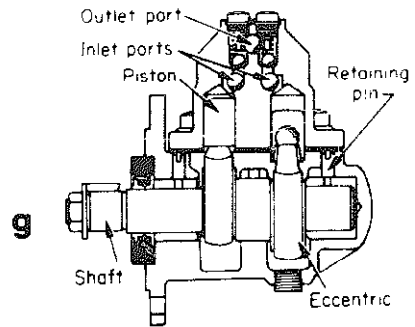

g

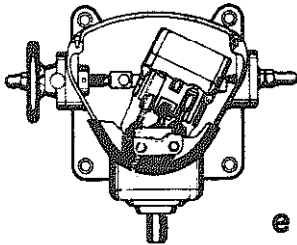

e

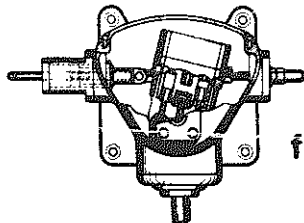

f

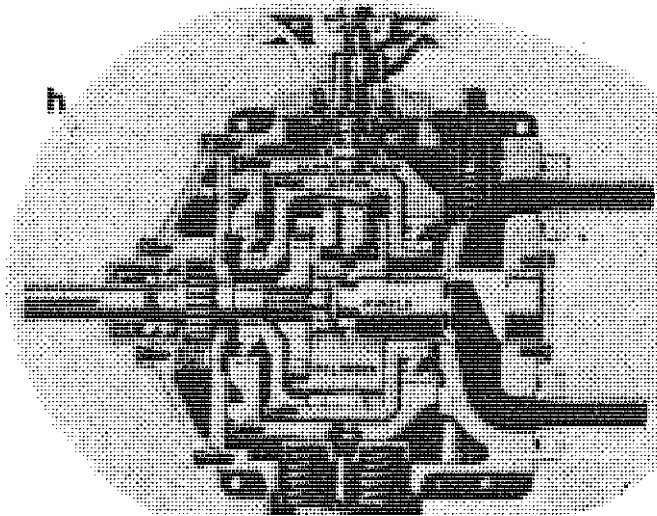

h

**B—Pumps**

**4—CENTRIFUGAL PUMPS**

**a—Volute type centrifugal pump.** Liquid enters through center and is thrown out by centrifugal force, from the impeller. It leaves the vanes at higher pressure and velocity compared to its entering. The velocity is then partially transformed into higher pressure.

**b—Diffuser type pump.** The impeller is similar to volute type pump, but around it are stationary diffuser blades curved in the opposite direction of the impeller blades. Less slippage, and higher efficiency than “a”.

**c—Impeller design: open type.**

**d—Semi-open impeller.**

**e—Closed impeller design.**

**f—Propeller type pump.**

**g, h, j, k—Impeller designs based on specific speeds.**

**l—Screw-type pump for heavier fluids.**

**m—Steam jacketed cam and piston pump.**

**n—Three-lobe pump.**

**p—Special vane pump.**

**q—Two-lobe pump.**

# CENTRIFUGAL PUMPS

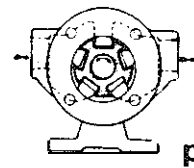
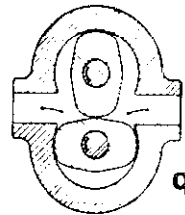
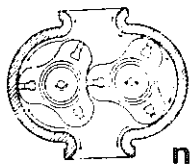
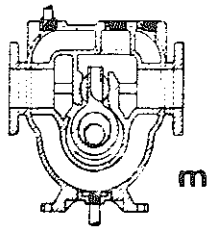
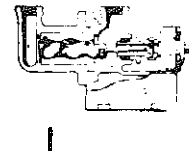
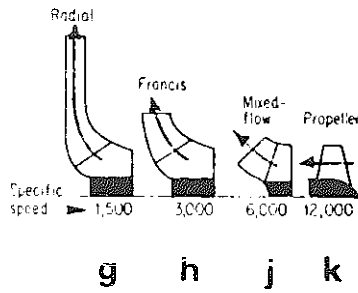
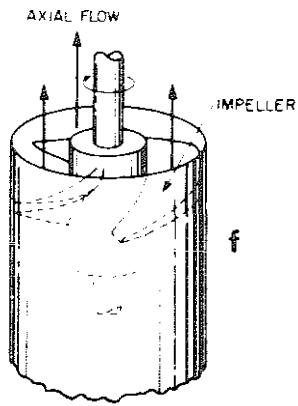
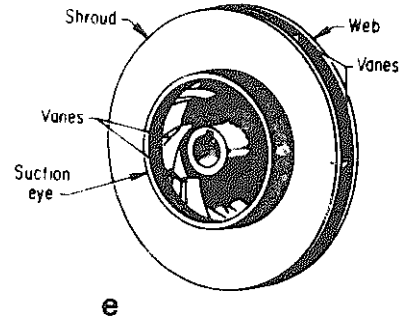
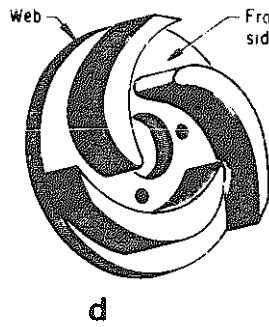
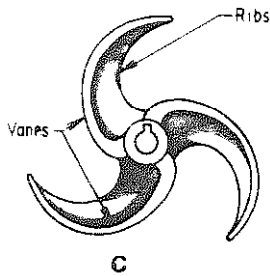
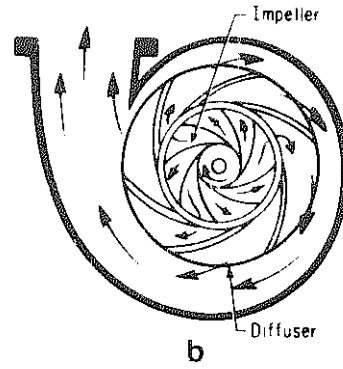
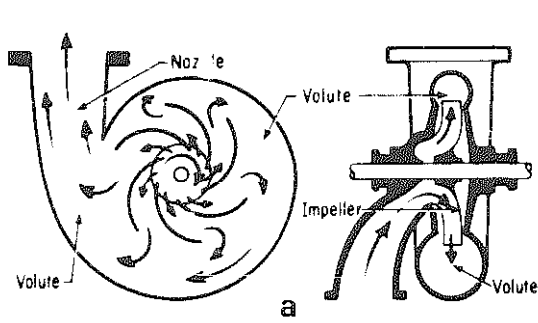

## B—Pumps

### 5—MISCELLANEOUS

a—**Racine vane pump**, A constant pressure pump which permits variable discharge. Degree of offset of rotor determines the delivery in gpm.

b, c—Operation of pressure compensated variable volume pump. Spring loads pump to maximum displacement position. Pressure from output pushes ring away from rotor, until it reaches dead center. Watch the gages. Maximum volume with zero pressure, or maximum pressure with zero volume are the limits.

d, e, f—**Hele-Shaw radial-piston pump**; sliding shoes maintain contact between the pistons and the outer ring; drilled passages in the stationary spindle lead to internal parts that register with the open ends of the revolving cylinders.

g—**Hele-Shaw radial-piston pump**; neutral position.

h—Same as “d” but the piston assembly has been rotated and moved to the left.

j—Same as “d” with the piston assembly rotated to the left.

k—**Screw-type rotary pump** for pumping heavy oils.

l, m—**External-screw pump**.

n—Variable delivery, check valve axial piston pump. Pistons are moved back and forth by rotating the inclined wobble plate. Suction opens inlet check valves; as the piston pushes forward, the fluid pressure opens the discharge check valves.

MISCELLANEOUS

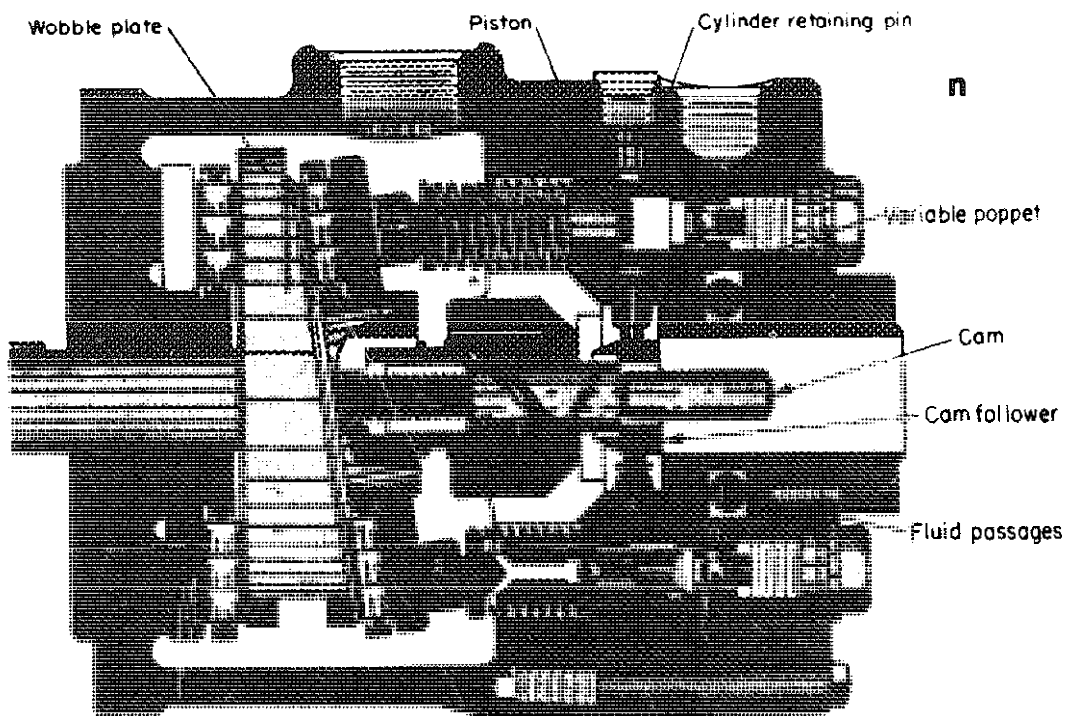
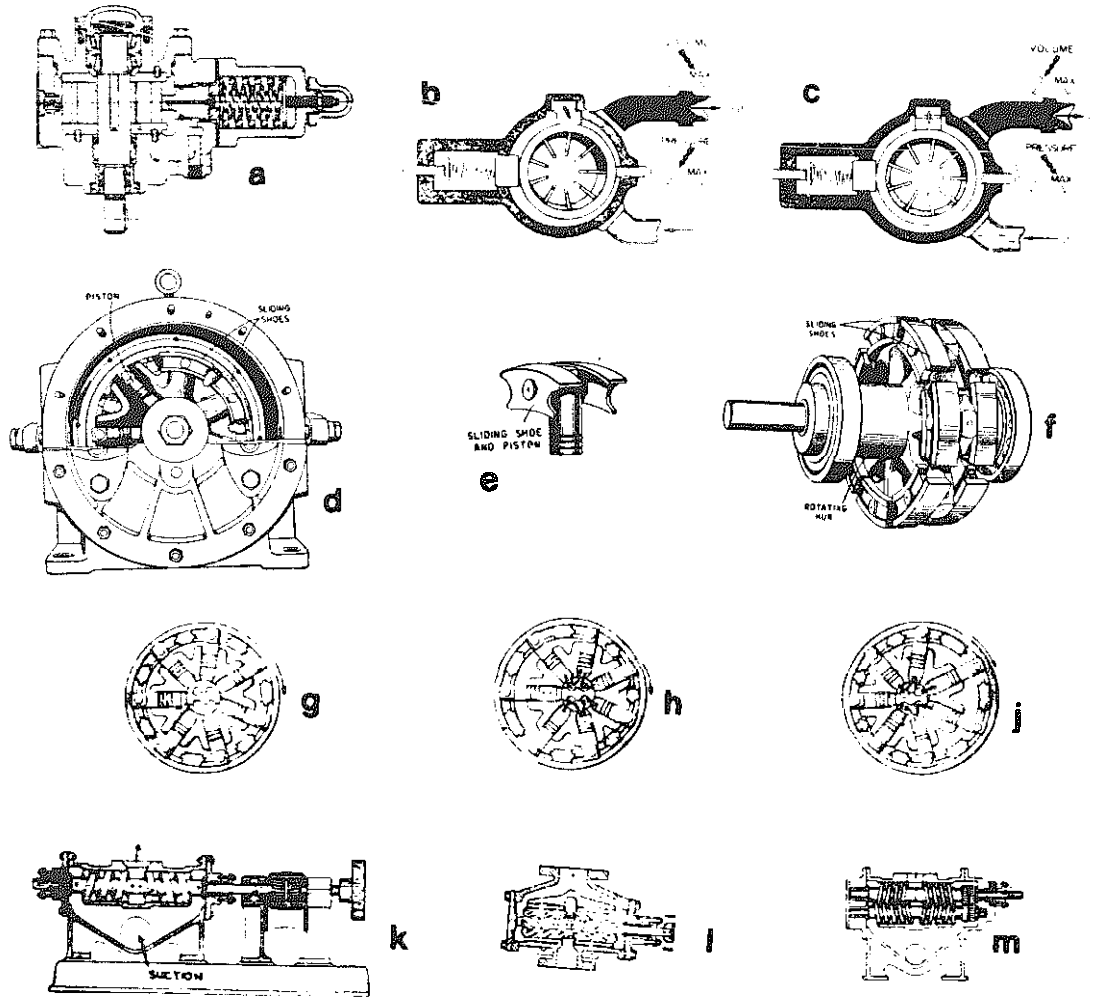

## C—Valves

**l—MANUAL VALVES.** There are a great variety of valves, and they will be grouped according to type and function.

**a—Globe valve, needle type.** Used to restrict oil flow, for example to pilot control circuits. A fine adjustment is possible. (Vickers Div., Sperry Rand Corp.)

**b—Globe valve, plug type.** Used to open or close a portion of a control circuit. (Vickers Div., Sperry Rand Corp.)

**c—Angle valve, plug type.** Used to open or close a portion of a control circuit. (Vickers Div., Sperry Rand Corp.)

**d—Angle valve, needle type.** Use same as “a”.

**e—Rotary spool valve.** It consists of a cylindrical body with four ports, and a specially machined spool. It is a directional control valve.

**f—Positions of the rotary spool valve.** Pump connected to D, E to tank

**g—Rotary spool position: all ports blocked.**

**h—Rotary spool position: pump to E; D to tank**

**j—Rotary plate position valve.** A directional control valve like “e”

**k—Ball valve.** Hole through ball permits flow. A 90° turn of handle shuts valve off.

**l—Gate valve.** Large opening with smaller pressure drop globe or angle valves. Used fully open or closed.

**m—Manual lever operates four way directional valve.** Vickers DG 17 S 4 valve. (Vickers Div., Sperry Rand Corp.)

MANUAL VALVES

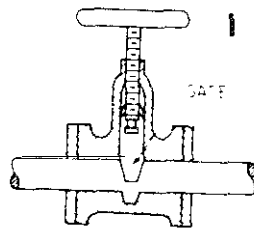
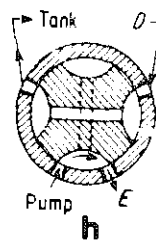
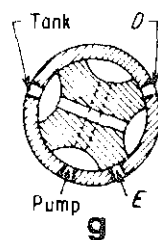
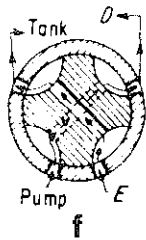
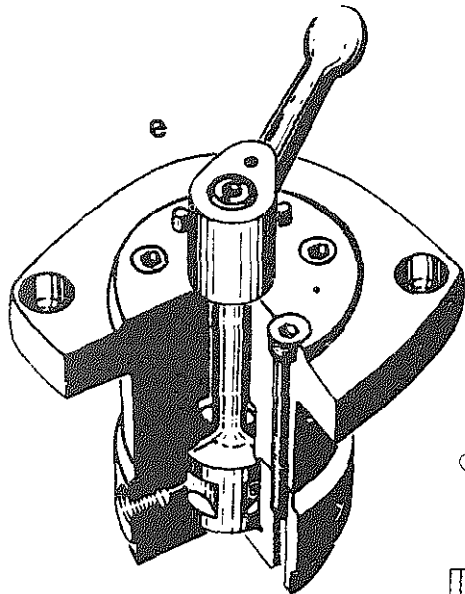
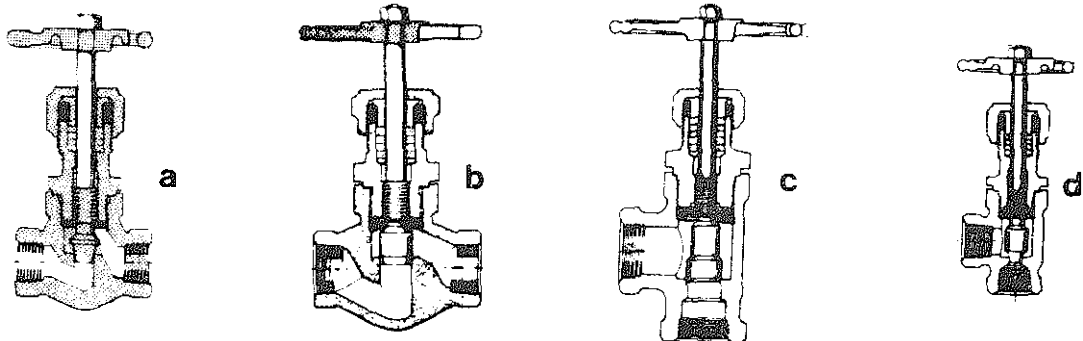

Through hole -  
90 degrees rotation to change from  
fully open to fully blocked

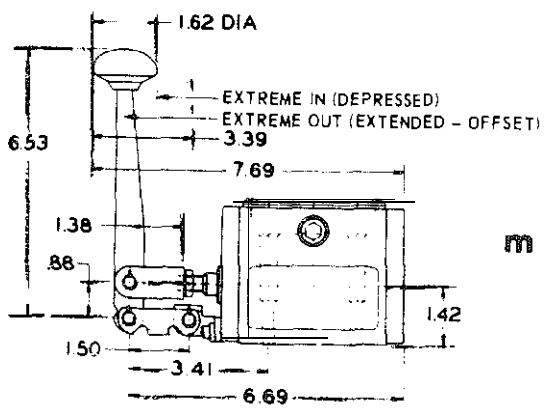
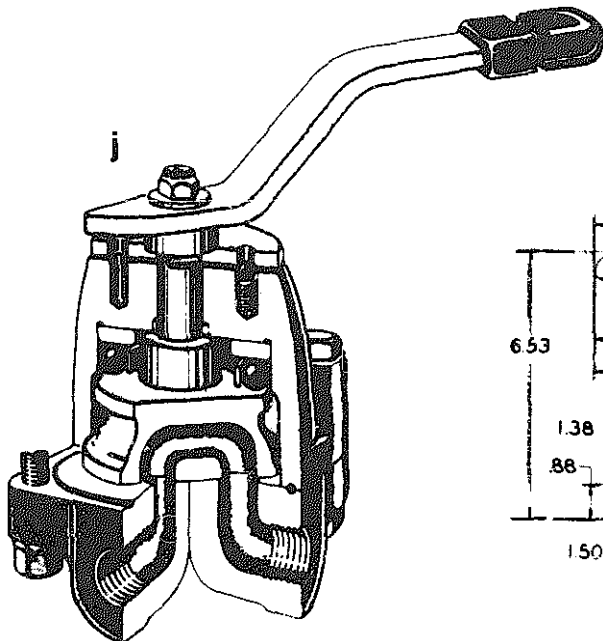
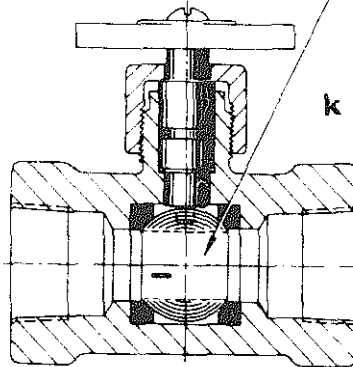



C—Valves

2—PRESSURE CONTROLLED VALVES

- a—**Angle check valve.** Spring holds poppet against seat. Fluid under pressure overcomes light spring and flows through valve unhindered. Reverse flow through valve blocked.
- b—**In-line check valve.** Works same way as "a". (Teledyne Republic Manufacturing Co.)
- c—**In-line check valve** using ball, instead of poppet
- d—**Shuttle valve.** Has two inlets and one outlet. Permits free flow from high pressure side, while blocking low pressure side. (Teledyne Republic Manufacturing Co.)
- e—**Non-adjustable safety valve.** Should be operating only in case of malfunction.
- f—**Hydraulic fuse.** Membrane ruptures when fluid exceeds predetermined pressure.
- g—**Deceleration valve, for cam operation.** This valve decreases flow to a cylinder or other device, to bring it to a gradual stop at the end of the travel.

PRESSURE CONTROLLED VALVES

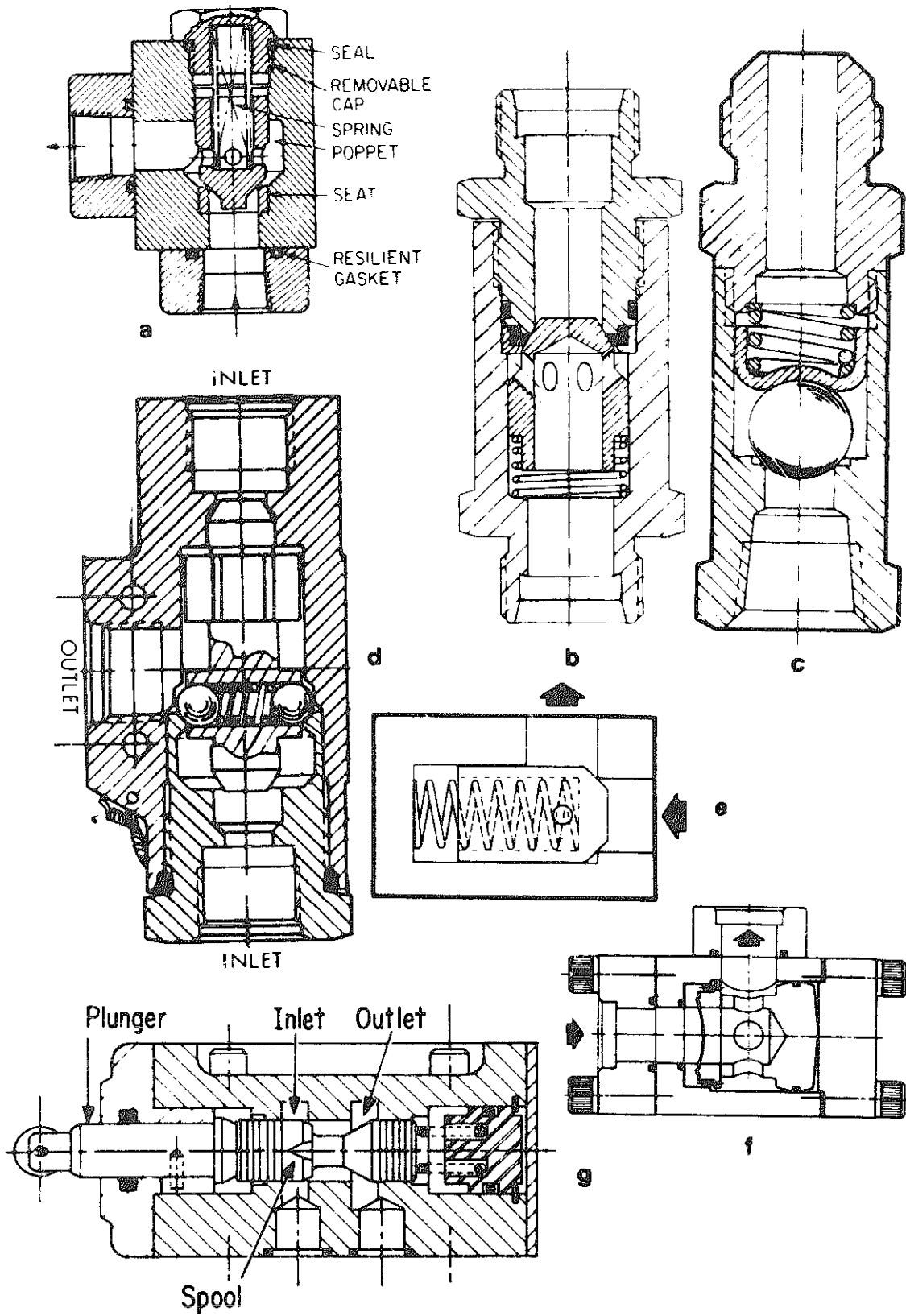

C—Valves

3—FLOW CONTROLLERS

**a—Vickers relief valve.** A balanced piston type relief valve, with piston of equal areas on both sides. Oil flows under the piston through the valve. A small passage in the piston permits oil to get to the upper side of the piston. If adjustment spring is compressed oil can escape directly to tank through main piston.

**b—Normally open pressure-control valve.** Through-flow permitted until preset pressure level is reached. Then fluid pressure overcomes adjusted spring and rising piston blocks or restricts passage.

**c—Pressure reducing valve.** Reduced pressure is obtained by restricting the flow to the low pressure circuit. As back pressure rises piston is moved and compresses spring. Shape of piston restricts passage orifice.

**d—Vicker's sequence and unloading valve.** Oil entering pressure inlet is blocked until pressure through pilot passage acting on lower end of pilot piston compresses spring. (Vickers Div., Sperry Rand **Corp.**)

**e—Adjustable compensated flow-control valve.** Inlet goes directly to reducing valve, held normally open by spring pressure. Two signals, from upstream and downstream of the adjustable orifice, impede and help the spring to maintain proper flow control.

**f—Solenoid controlled dump and shut-off valve.** Obtainable normally open or normally closed. (Teledyne Republic Manufacturing Co.)

**g—Typical circuit for "h".** The motor turns the unidirectional fixed displacement pump. Pump syphons oil from tank, pushes it through check valve to service line. Should the pressure from the pump exceed desired pressure, a relief valve will dump the oil into the tank. Should the pressure reach an undesirable value after the check valve, the pressure switch will energize the solenoid of valve described under "h"; the piston will shift, dumping the oil into the tank.

**h—Two stage solenoid pilot-operated valve.** T, tank; P, pressure port; A and B, connecting ports to cylinders etc. This valve is a direction-control valve. Small valves may be manually controlled or solenoid controlled. In this design a small pilot valve is controlled by the solenoid.

**j—Spool configuration.** Semi-open center, P, A and B open to T. Many other configurations of the spool, and body coring are possible.

# FLOW CONTROLLERS

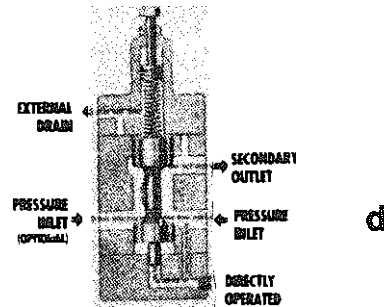
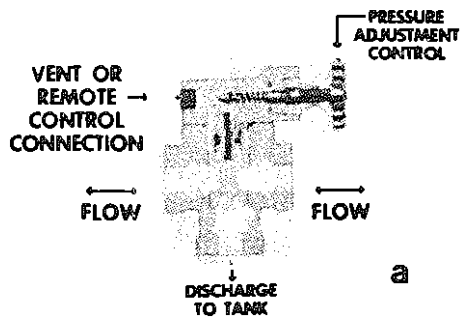
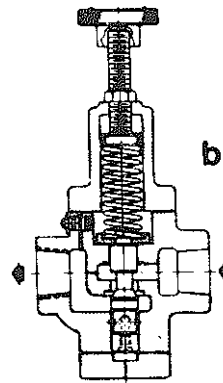
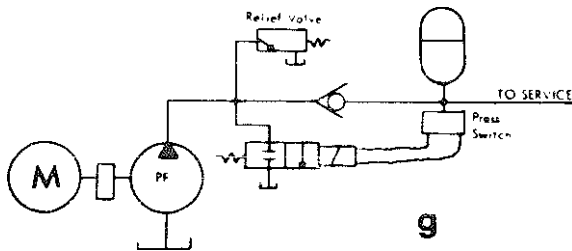
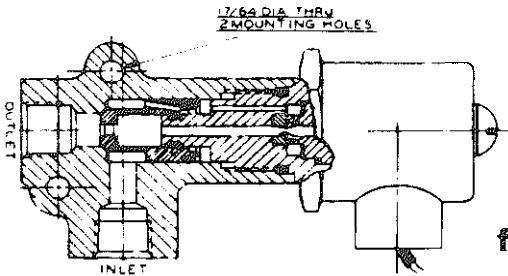
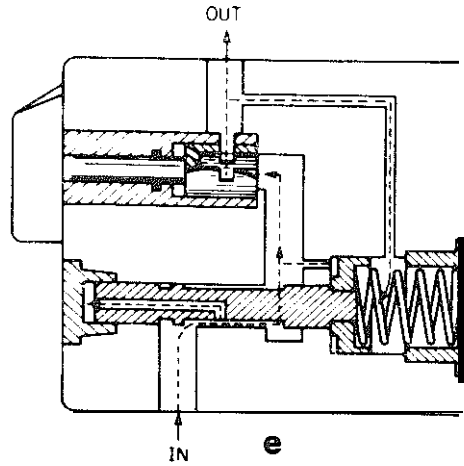
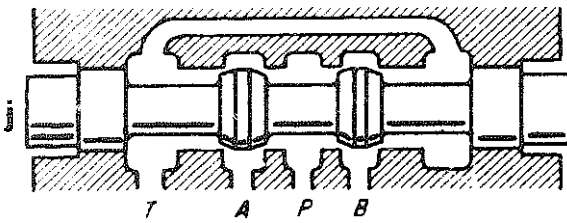
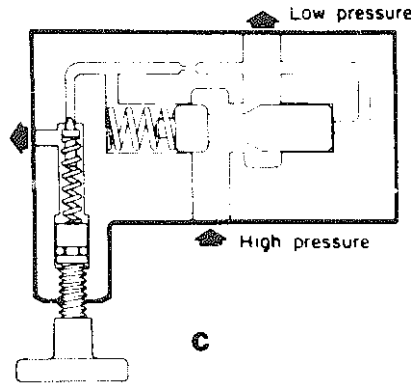
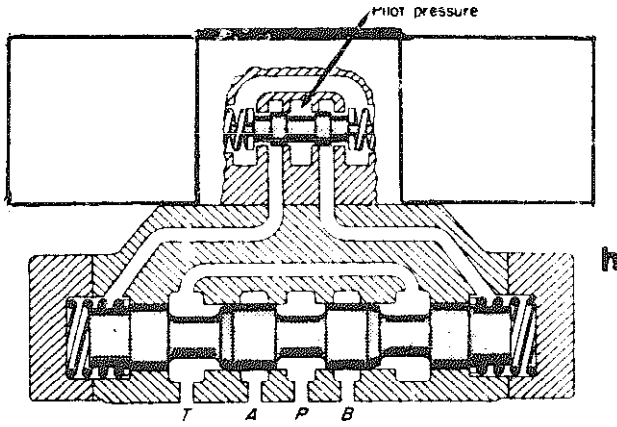

## D—Hydraulic Components

1—**TUBE FITTINGS.** Pipes used for hydraulic plumbing are classified as standard (schedule 40), extra-strong and double extra-strong. They go by wall thickness and nominal size. Tubing is designated by its actual outside diameter. Hoses are used for flexible connections, and fittings provide mechanical attachments for lines or port entry.

a—**Standard pipe** (schedule 40).

b—**Extra-strong pipe** (schedule 80).

c—**Double extra-strong** (close to schedule 160).

d—**NPT threaded pipe section.** Taper pipe threads are used on pipes only.

e—**Three piece flare fitting** for hydraulic tubing. Accepted flare angles are  $37^\circ$  or  $45^\circ$ . This type is called nut and sleeve type. Sealing pressure obtained through nut, actually sealing through the sleeve.

f, g—**Proper preparation of flare,** showing maximum and minimum flare

h—**Tubes** must be bent properly. Radius is measured to centerline of tubing. Look at tables for minimum radii for given tube sizes.

j—**Three piece flareless fitting** shown with tubing before assembly. (Parker-Hannifin Corp., Ferulok Tube Fitting)

k—**Ferulok Tube Fitting** assembled on tube.

l—**Assembled Ferulok Tube Fitting** showing ferrule “bite” into tube.

m—**Flareless tube fitting** using inverted ferrule.

n—**Flareless two piece tube fitting** using threaded sleeve.

p—**Welding** of pipe joint to flange.

q—**Welding** two pipes together.

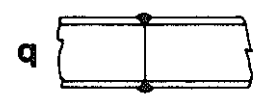
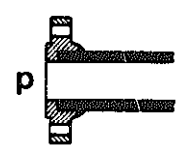
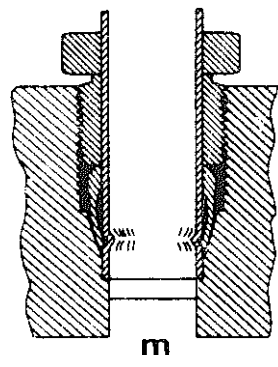
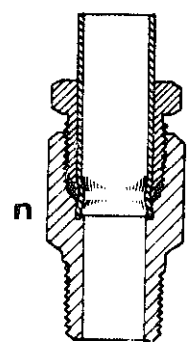
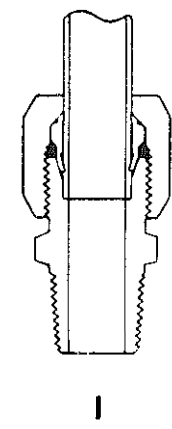
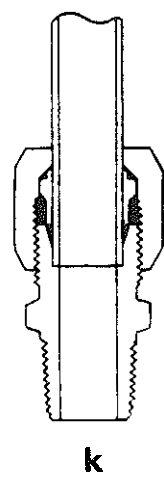
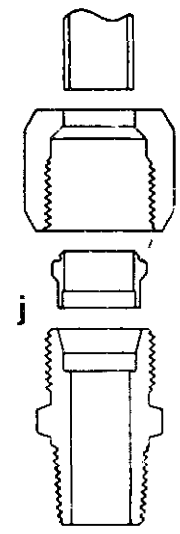
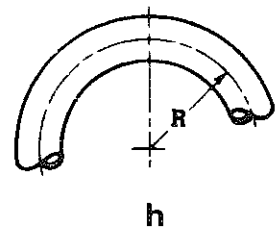
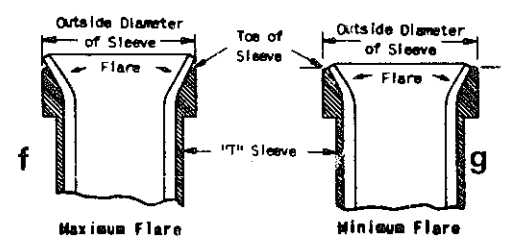
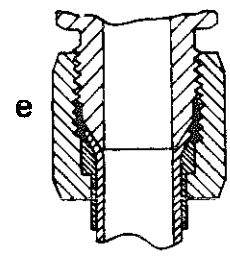
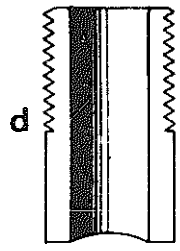
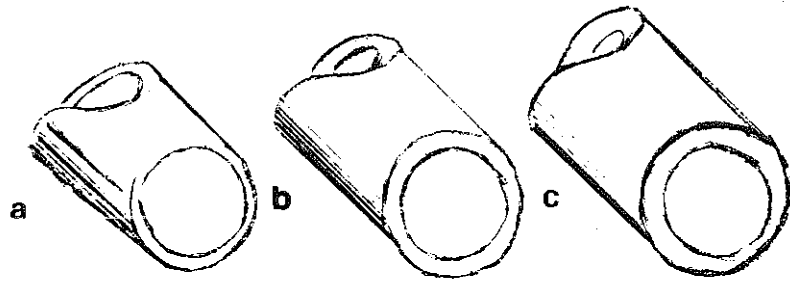

## D—Hydraulic Components

### 2—HOSES, AND HOSE FITTINGS

a—Right way to install steel tubing.

b—Wrong way to install steel tubing.

c—Same as “a”.

d—Same as “b”.

e, f, g, h, j—Various types of hose constructions.

k, l—Right and wrong way to install a hose.

m, n—Right and wrong way to install a hose, twisting in flexure must be minimized.

p, q—Right and wrong way to install a hose.

r, s—Right and wrong way to install a hose.

t—Straight thread hose connector, Hoze-lok type 20. Note the straight thread with O-ring to connect to port and the clamping arrangement for the hose on the opposite side. (Parker-Hannifin Corp.)

u—Hose assembled to fitting. (Parker-Hannifin Corp., Hoze-lok, type 40)

v—Quick disconnect coupling.

# HOSES & HOSE FITTINGS

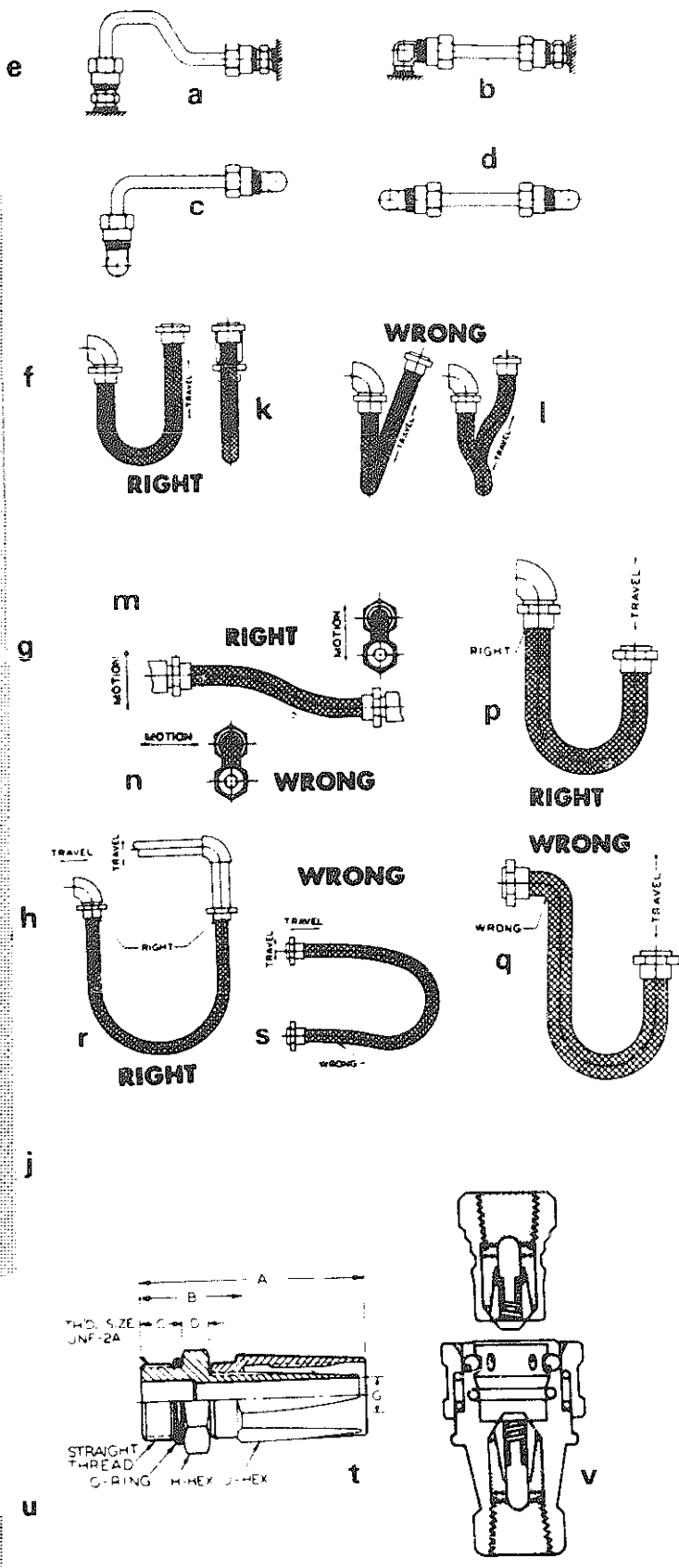
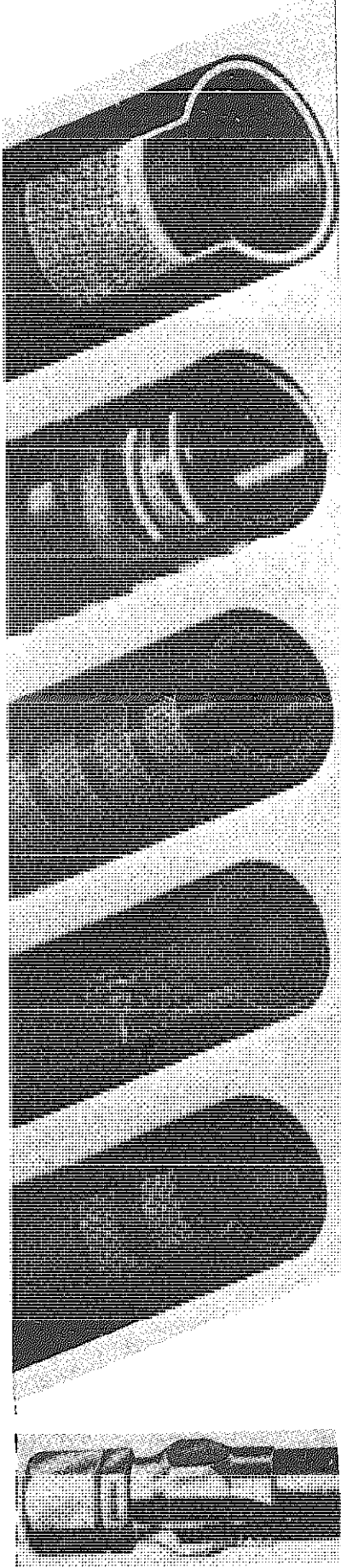



**D—Hydraulic Components**

**3—SEALS**

**a - Piston** fitted with two leather-cup packings for hydraulic elevator or crane.

**b-V-ring hydraulic packing**, showing the critical dimensions.

**c-leather cup packing** on ram.

**d-Press** for molding cup leathers.

**e-Spring expander** (finger type) for cup packing to hold packing to wall.

**f-Coil spring expander**. Note design of spring retainer.

**g—O-ring seal**.

**b-Cross-section of Parker T-seal** with back-up rings. Used similar to O-ring. (Parker Seal Co.)

**j—PolyPak**, combines molythane lip-type seal with squeeze type synthetic rubber O-spring. (Parker Seal Co.)

**k-v-packings**. This type is efficient for stuffing boxes. (Parker Seal Co.)

**I-Parker-Rockwell** molded lip-type packing. (Parker Seal Co.)

**m-Molythane wiper ring**. (Parker Seal Co.)

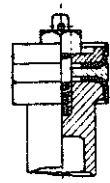

a

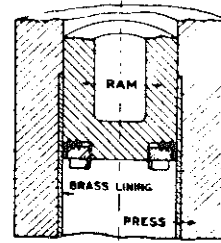
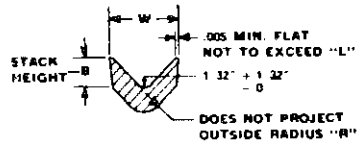

c

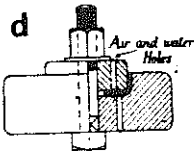

d

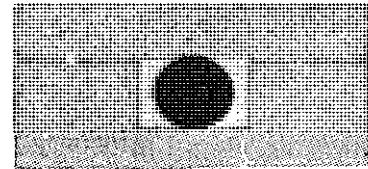
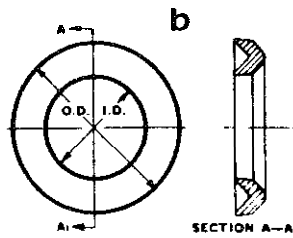

g



e

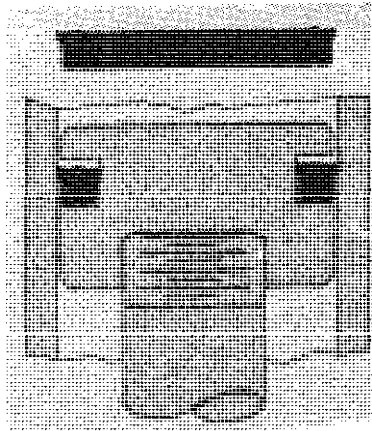

j

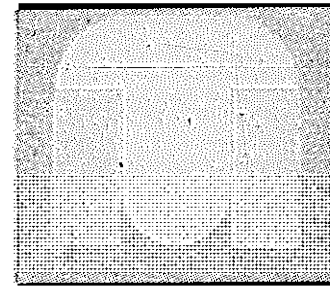

h

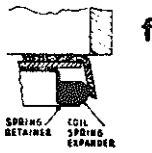

f

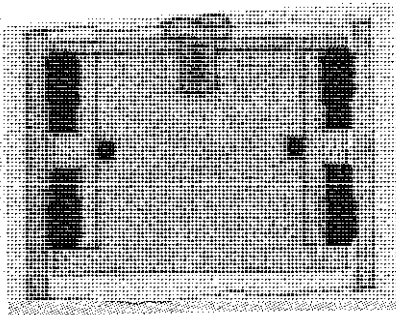

k

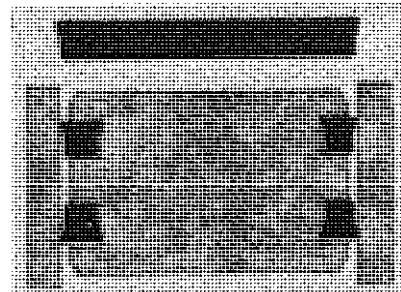

l

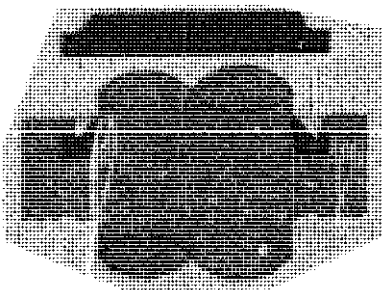

m

## E—Hydraulic Systems

1—SYMBOLS are used to transmit precise information about the functioning of a fluid power circuit. They are standardized and undergo changes from time to time.

**a**—Working line.

**b**—Pilot line.

**c**—Drain line.

**d, e**—Joining lines.

**f, g**—Crossing lines.

**b**—Fixed displacement pump, unidirectional.

**j**—Motor, unidirectional.

**k**—Variable displacement pump, unidirectional.

**I**—Variable displacement motor, unidirectional.

**m**—Single acting cylinder. Symbol indicates piston, piston rod, cylinder and fluid port.

**n**—Double acting cylinder with single rod.

**p**—Double acting, double rod end cylinder.

**q**—Same as “n”, except oversize rod.

**r**—Enclosure, used to surround a group of symbols, like components of a manifold etc.

**s**—Relief valve, indicates connection to tank.

**t**—Sequence valve. Note similarity to relief valve symbol, except that it actuates another circuit when actuated.

**u**—Unloading valve.

**v**—Pressure regulating valve. Note that the pressure actuation comes from downstream.

**w**—Fixed restriction (orifice).

**x**—Variable flow control valve.

**y**—Pressure compensated flow-control valve.

**z**—Variable pressure compensated flow control valve.

**aa**—Check valve.

**ab**—Check valve in parallel with orifice.

**ac**—Two position, three-way valve.

**ad**—Two position, four-way valve.

**ae**—Three position, four-way valve. The spool of the valve is spring centered, and all four lines are blocked in center position. The symbol of the small boxes on each side indicate that the valve is solenoid controlled. Each block corresponds to a spool position.

**af, ak**—Some possible center position porting for valve “ae”.

**at**—Reservoir line extends below fluid level.

**am**—Fluid return line terminates above fluid level.

**an**—Drain line terminating above fluid level.

SYMBOLS

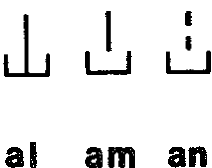
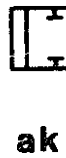
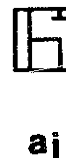
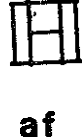
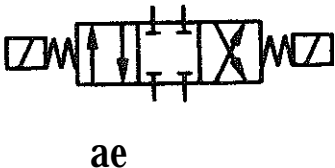
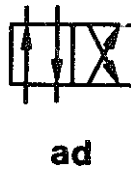
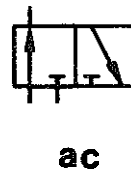
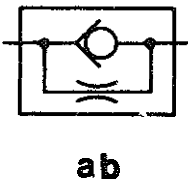
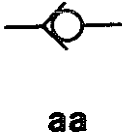
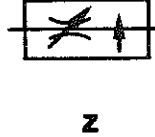
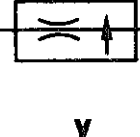
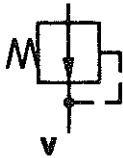
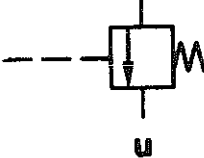
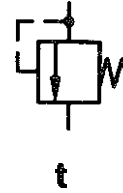
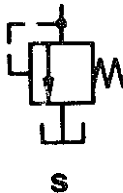
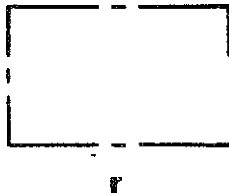
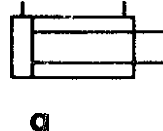
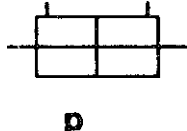
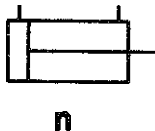
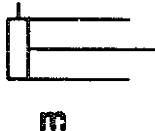
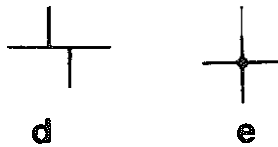
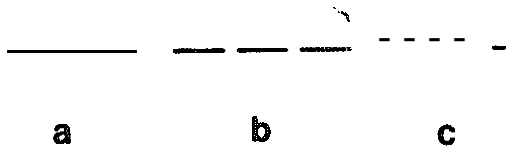

## E-Hydraulic Systems

### 2-SAMPLE CIRCUIT

a-Simplified hydraulic circuit of shaper. Pictorial representation.

b-Circuit description using graphic symbols. Fixed displacement pump (2), driven by motor takes oil from oil reservoir (1). Should the pressure developed by the pump exceed the design pressure, relief valve would dump the oil into the tank, until proper pressure is obtained. In operation, directional control valve (3) will direct the fluid under pressure first to one side of the cylinder (5), until lever (4), tripped by stop (8) will shift the spool in the three position, four-way directional control valve (3) to the opposite side, thereby reversing the fluid flow. The return stroke will be faster than the cutting stroke due to the volume occupied by the piston rod.

SAMPLE CIRCUIT

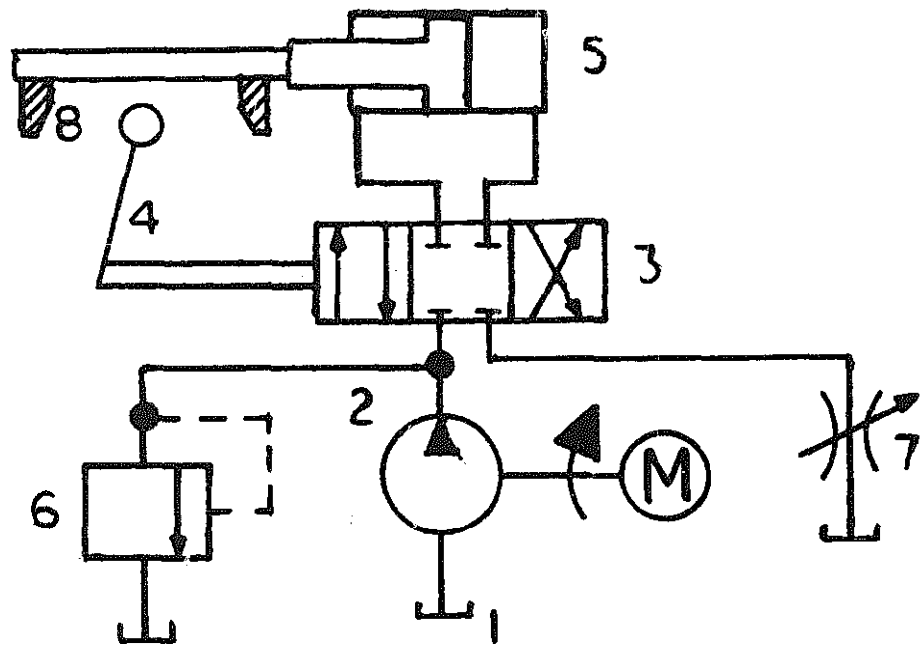
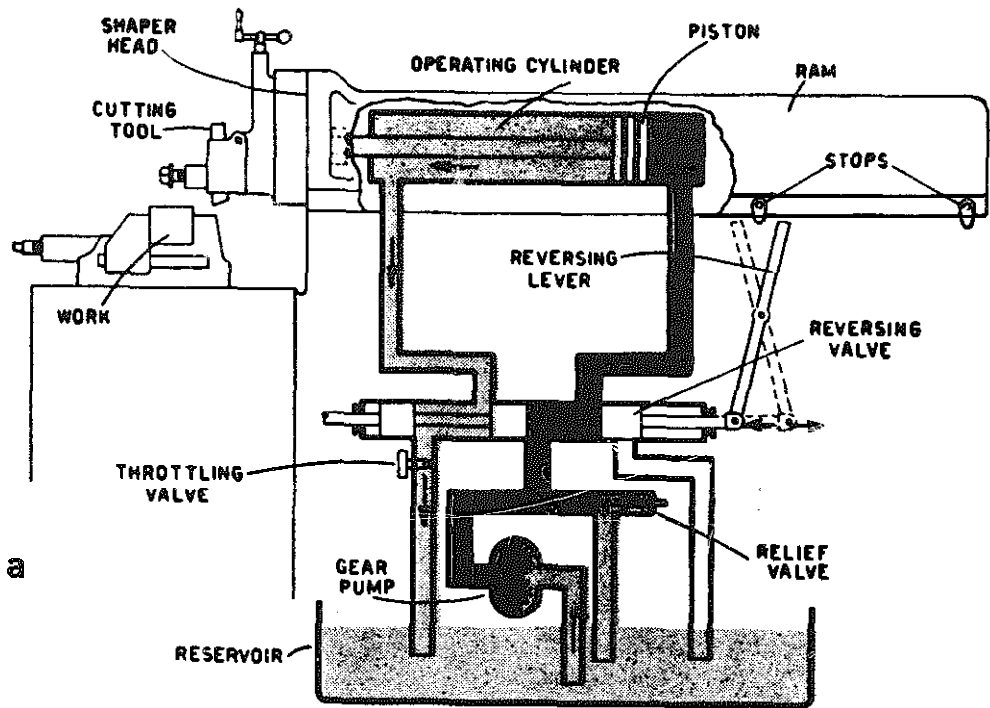

## V INDUSTRIAL PROCESSES

## A-Tools

**1-HAND TOOLS.** For assembly, model work etc. hand tools are still of great importance.

**a - Flat file.** These are usually double cut on the faces and single cut on the edges.

**b - Hand file.** Usually parallel in width, and tapers in thickness for about 2/3 of its length.

**c-Square file.**

**d-Pillar fde.**

**e-Round file.**

**f-Triangular file.**

**g-Half-round fde.**

**h-Needle file.** These are very delicate and are used for fine work only.

**j--Proper way to file.**

**k-Rifflers,** for filing inside of castings.

**l-Surface plate** to check accuracy of a job.

**m-Flat drill** has been replaced by twist drill.

**n-V-block** and clamp. Used for holding circular bars.

**p-Center punch.**

**q-Automatic center punch.** No hammering; press handle down, built in mechanism strikes center mark. (L. S. Starrett Co.)

**r-Table vise.**

**s.t-Pin vises.**



HAND TOOLS

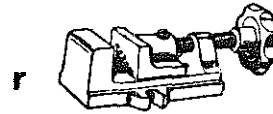
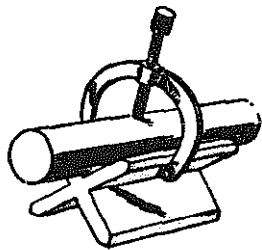
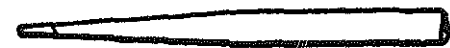
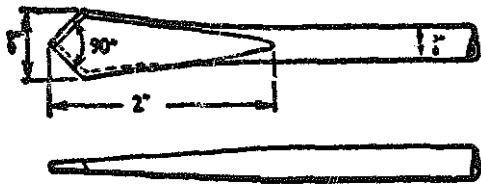
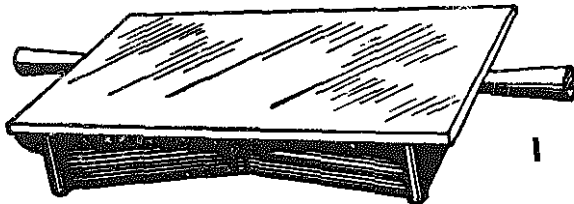
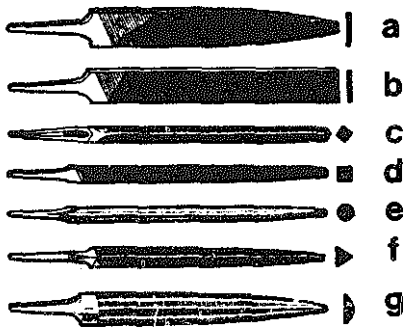

s  
HOLE THROUGH CENTER

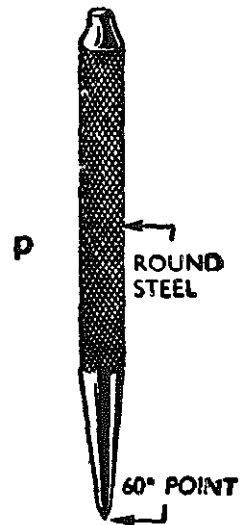
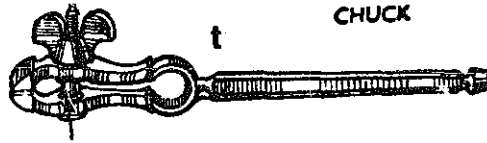

A-Tools

1-HAND TOOLS (Cont)

**u-Taper reamer** with straight flutes.

**v-Straight reamer** with spiral flutes. To enlarge drilled holes to precise size.

**w-Reamer** for morse-taper.

**x-Reamer**, expansion type.

**y-Stanley block plane** for planing across the grain; the angle is  $20^{\circ}$  for soft wood.

**z-Quarter round molding plane.**

**aa-Hand shears** or snips for sheet metal cutting.

**ab-Small bench shear**, may be used as nibbler.

**ac-Chisel.**

**ad-Side chisel** for removing metals from slots.

**ae-Use of caulking tool.**

**af-Use of fullering tool.**

**ag,ah,aj-Hand taps** are used in sets of three, (from left to right) taper, plug and bottoming.

**ak-Die-stock**, with adjustable die. Die for cutting external thread.

**al-Internal thread-chaser**, to go over poorly cut thread.

**am-External hand thread-chaser.**

**an-Parallel-jaw vise** with instantaneous grip.

**ap-Pipe-burring reamer.**

HAND TOOLS



aa



ac

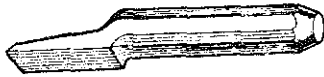

ad

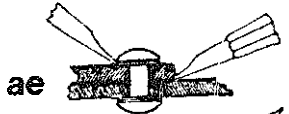

ae

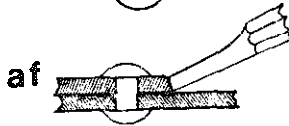

af

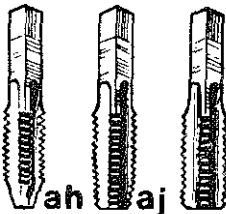

ag

ah

aj



al



am



ap



u



v



w



y

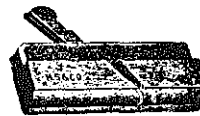

z

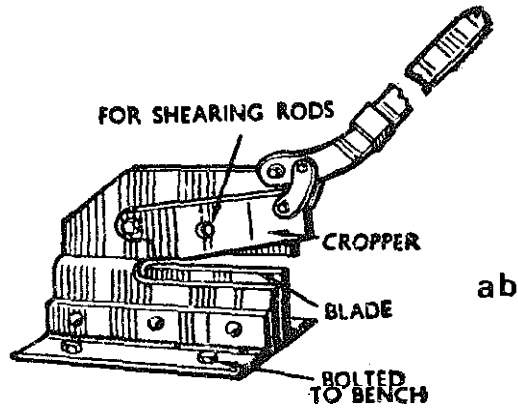

ab

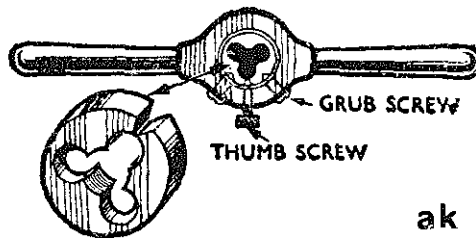

ak

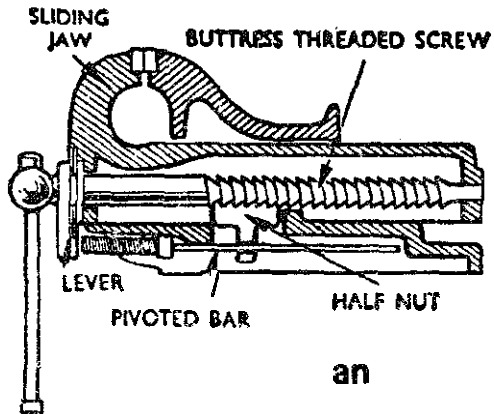

an

**A—Tools**

**1—HAND TOOLS (Cont)**

- aq—Pipe vise.** Used by steam fitters and plumbers.
- ar—Chain-vise.**
- as—Special jaws for vise.**
- at—Special jaws for vise to hold pipes.**
- au—Body hammer and dolly,** as used for body work on cars.
- av—Gear puller.**
- aw—Battery terminal puller** (for car batteries).
- ax—Body dent puller** (for body work).
- ay—Brass punch.**
- az—14" aligning punch** (for body work).
- ba—Hammer with brass jaws.**
- bb—Ball-peen hammer.**
- bc—Torque wrench,** to put proper torque on screws and nuts.
- bd—Pipe extension** on handle of torque wrench does not influence the reading.
- be—With this extension** the torque reading must be multiplied by 2.
- bf—Long-nose pliers.**
- bg—External snap-ring pliers.**
- bh—Wrench pliers.**
- bj—Box wrench offset** for hand-clearance.
- bk—Adjustable wrench.**
- bl—Openend wrench.**
- bm—Optician's screw driver.** (L. S. Starrett Co.)
- bn—Pocket screw driver.** (L. S. Starrett Co.)

HAND TOOLS



af

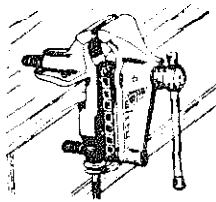

ar

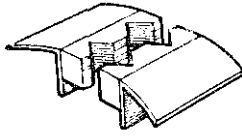

as

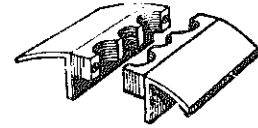

at

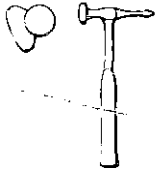

au

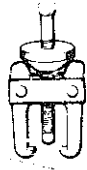

av



aw



ax



ba



bb

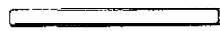

ay

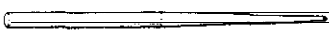

az

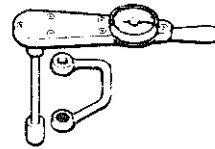

bc

bf

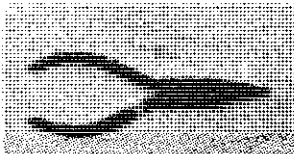

bg



bh

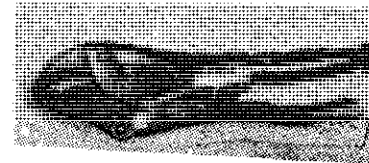

bd

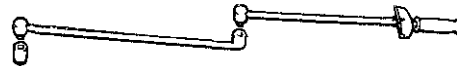

be

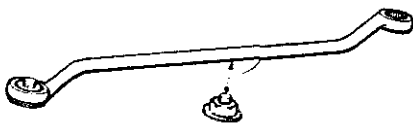

bj

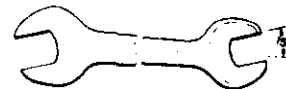

bl



bk



bm



bn

A-Tools

2-DRILLING

a-Straight shank drill.

b-Taper shank drill.

c-Center drill.

d-type of washer cutter which can be changed to fly-cutter.

e-Countersink bit for wood or soft metal.

f-Drill grinding fixture.

g-V-drill for metal seldom used.

h-Flat point or bottoming drill.

j,k-Drill jig and exploded view. Jig is locked with quarter-turn wing screw.

l-Drill press in action. Jacobs chuck holding drill.

m-Turret spindle for drill press. Originally designed by DeWalt and Fant.

n,p-Counterbored and spotfaced hole.

q-Counterbore with pilot.

r-Tap.

s-Jacobs drill chuck. Holds drills with straight shanks.

t-Counter sink.

# DRILLING

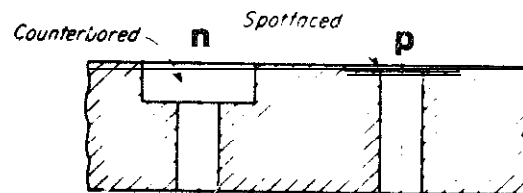
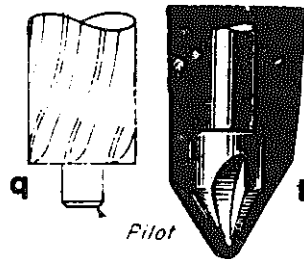
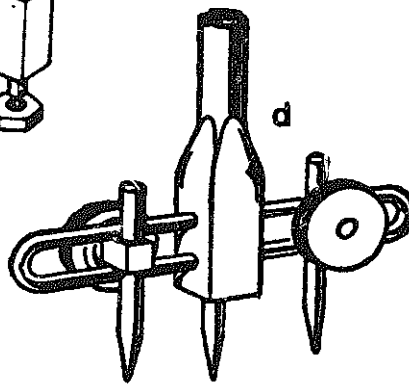
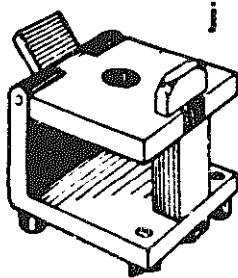
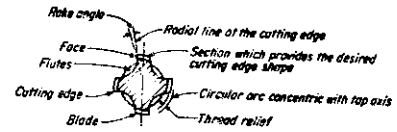
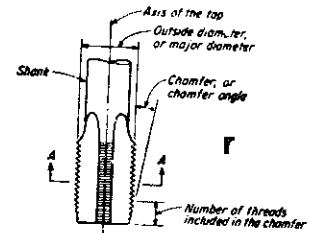
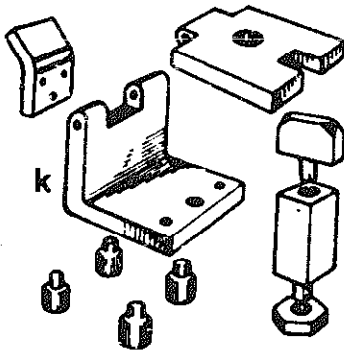
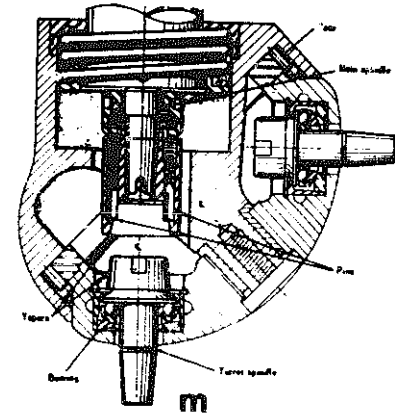
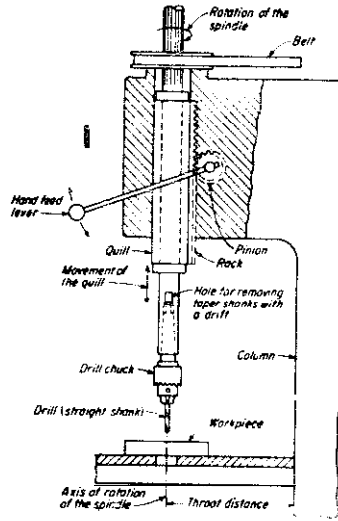
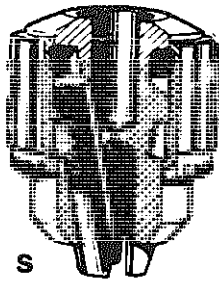
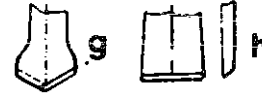
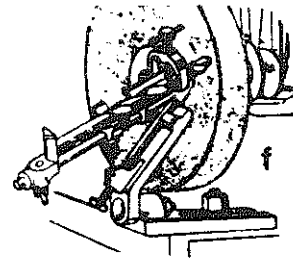
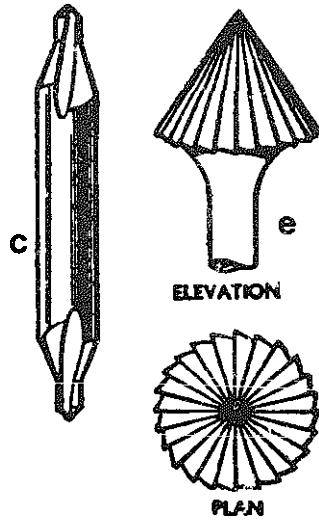
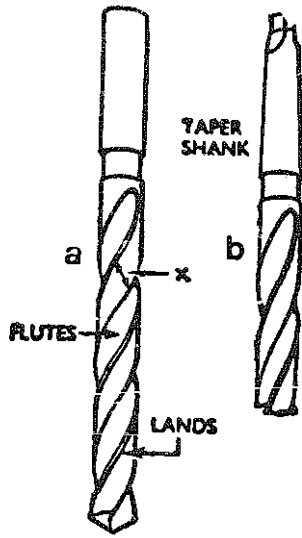

A-Tools

3 -CUTTING AND TURNING TOOLS

a-Pipe cutter with V-edged cutting roller.

b-Slitting discs for cutting sheets into strips.

c--Revolving cutter head, for tenoning, molding, etc.

d-Reaping machine cutters with a series of scissor-shaped knives, one set fixed and the other reciprocating.

e-Wire-cutter discs, one fixed, the other attached to a hand lever; they have corresponding holes of various sizes in both discs.

f-shears.

g-Tubular machine cutter for woodworking; it is easily sharpened and can be revolved to present fresh cutting edges to the work.

h-Scrovi saw, fret saw, or jigger.

i-Three-cutter tube shears with worm-gear motion.

k-Pin borer for cutting out circular blanks with a central hole, such as washers, etc.

l-Inserted circular saw teeth easily sharpened or replaced.

m-Expansive facing, or boring pin bit.

n-Revolving cutter, with adjustable inserted circular cutter.

o-Wobbling circular saw for cutting dovetail grooves.

p-Chain cutter.

q-Turning knife tool for metal cutting.

r-Turning front tool for metal cutting.

s-Chasing tool for cutting V-threads.

t-Hollow-taper bung borer.

u-Screw tool for cutting square threads.

v-Cutting discs for sheet metal, paper, etc.

w-Compound lever shears.

x-Square-hole boring bit for wood; a square chisel containing a twist drill.

y,z-Cylinder and fluted drills for enlarging and finishing holes.



# CUTTING & TURNING TOOLS

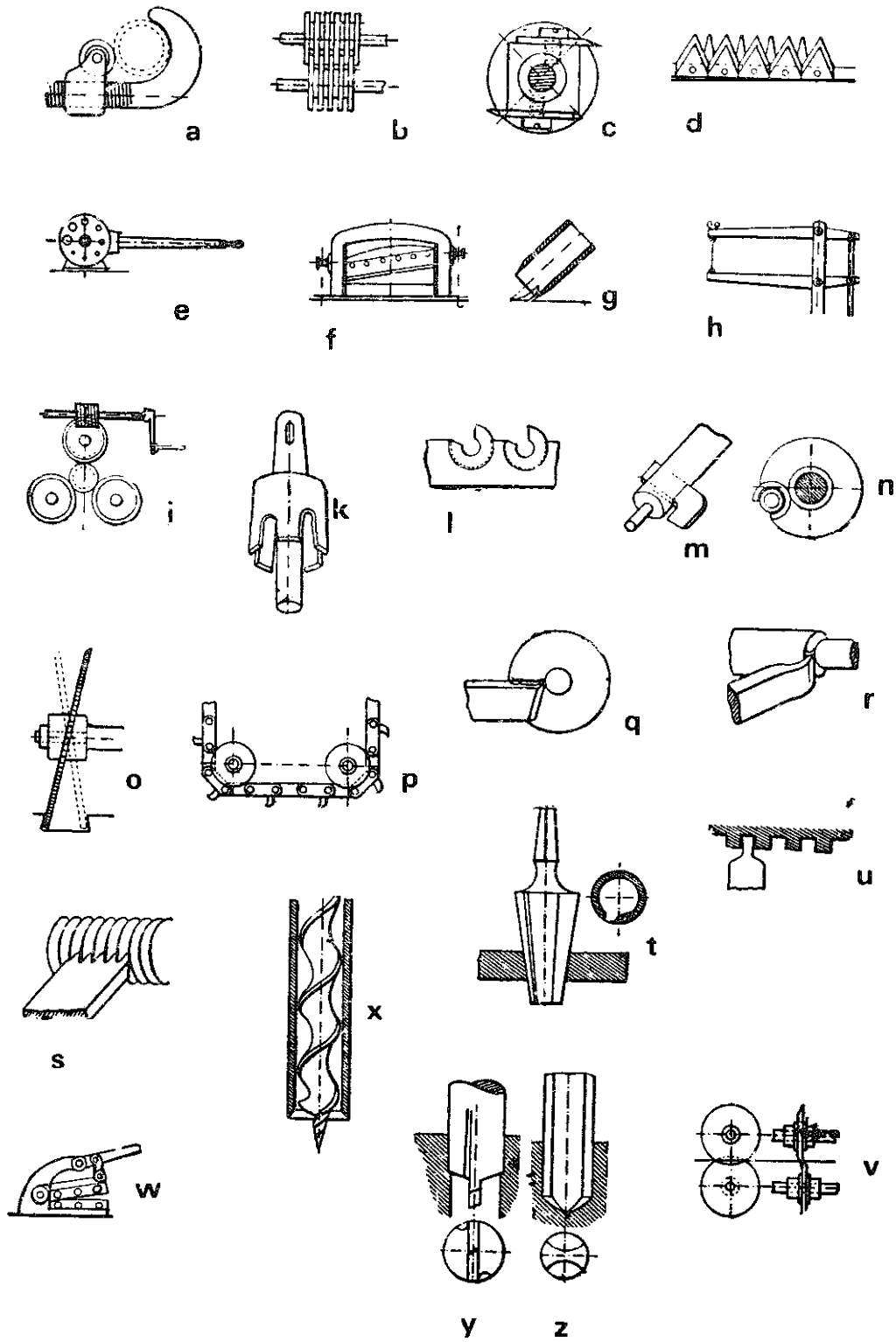

A - Tools

3-CUTTING AND TURNING TOOLS (Cont)

aa--Single p o i n t cutting tool. Detail of cutting section having positive rake angles.

ab--Side view of "aa."

ac--Thread cutting tool for 60° V-thread.

ad--Right-hand turning tool for metal.

ae--Boring tool.

af--V-tool.

ag--V-tool for inside threads.

ah--Side tool for square shoulders.

aj,ak--Boring tools for square shoulders.

al--Hand planing tool for soft metals, e.g., lead.

am--Hand planing tool for wood with the grain.

an--Hand planing tool for end grain.

ap--Paring gouge for wood.

aq--Hollowing gouge for wood.

ar--Tool holder for lathe, plane or shaper.

as--compound cylinder drill (related to gun drill).

at--Boring tool in action.

au--Boring head for clay and soft soils.

av--Wheel used as boring head, for soft materials.

aw--Boring-bar head. One of many types.

ax--Diamond studded borer, for coal etc

ay--Broaching tool. The broach is drawn through the work piece only once. The roughing teeth remove most of the material, the finishing teeth only a small amount. Only the first sizing tooth cuts, the others are of the same size. The burnishing teeth do not cut, they just smooth the metal.

az,ba--Boring-bars at work.

# CUTTING & TURNING TOOLS

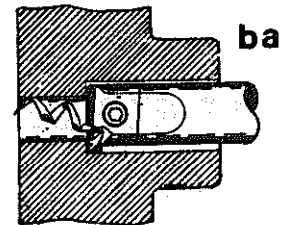
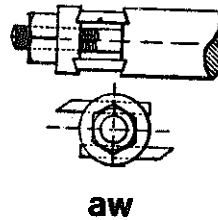
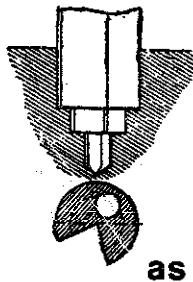
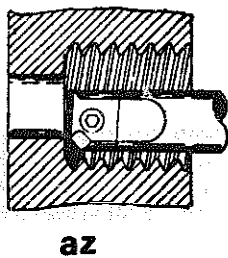
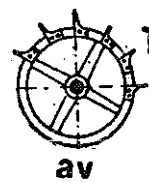
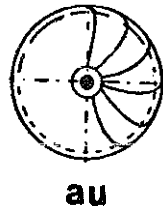
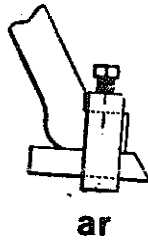
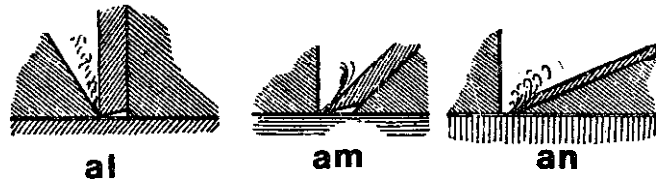
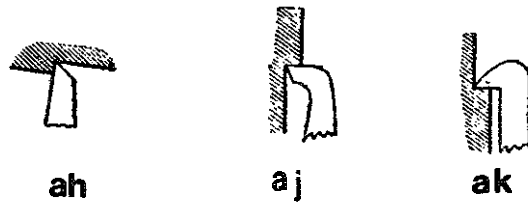
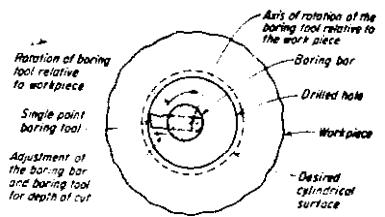
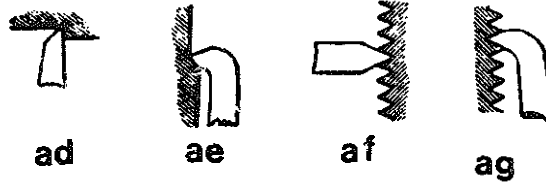
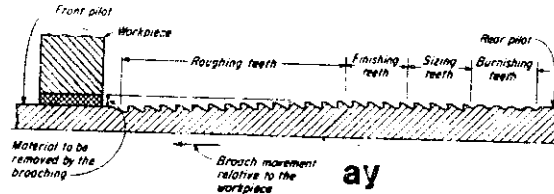
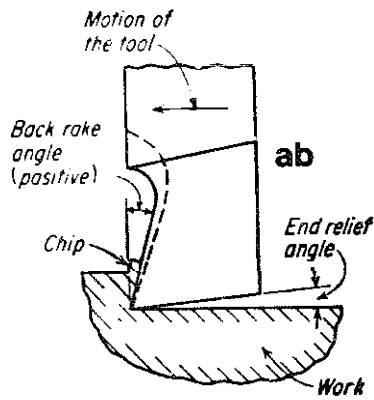
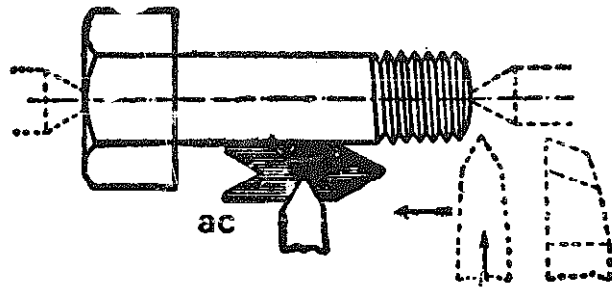
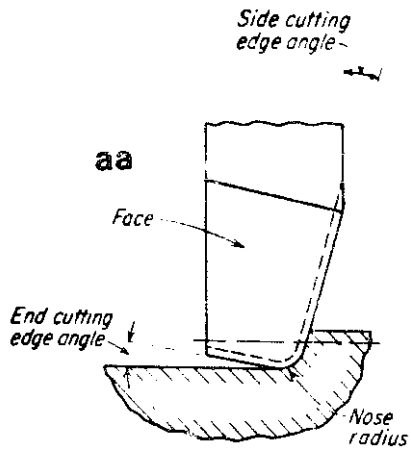

A-Tools

4-HOBS AND MILLING CUTTERS

**a-Gear hob** (for cutting teeth).

**b-Hobbing** a spur gear. The hob is rotated at a rate to give the cutting edge a suitable speed, and the blank is rotated at proper speed, since hob spindle and work gear arbor are connected by change gears.

**c-Generating** the teeth of a spur gear, using a cutter in the form of a pinion (Fellows process).

**d-Plain milling** cutter with helical teeth. (Slab milling cutter.)

**e-Milling** cutter with straight teeth.

**f-Side milling** cutter. (Used for slotting, straddle milling or general side or face milling).

**g-Inserted-blade milling** cutter, using tool steel, stellite or carbide-tipped inserts.

**h-Gear** cutter with radial teeth.

**j-Multiple-thread** miller for cutting threads.

**k-Slitting** saw with rake teeth for milling deep slots.

**l-End mill** with spiral teeth for die sinking, and for milling surfaces not conveniently reached by other cutters.

**m-End mill.**

# HOBS & MILLING CUTTERS

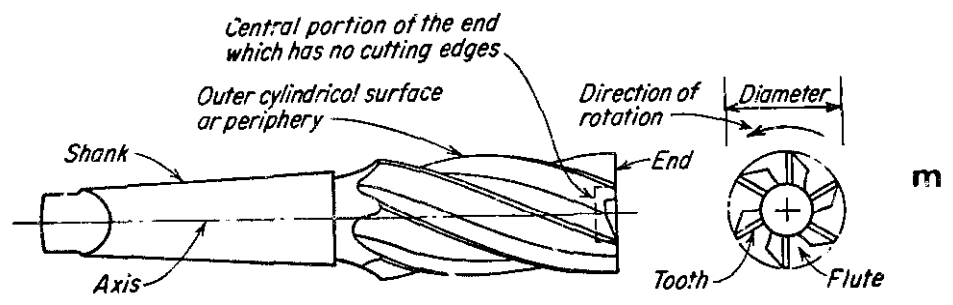
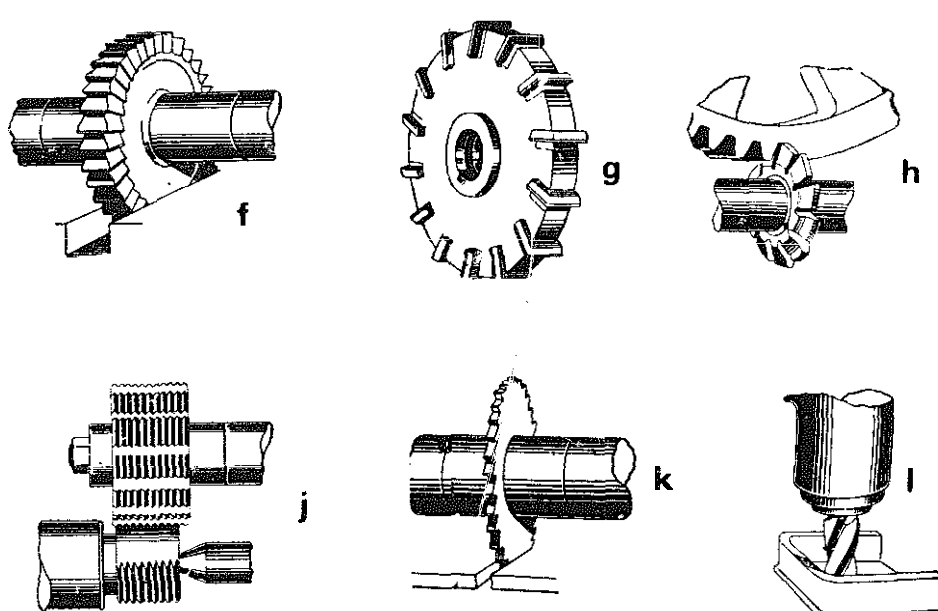
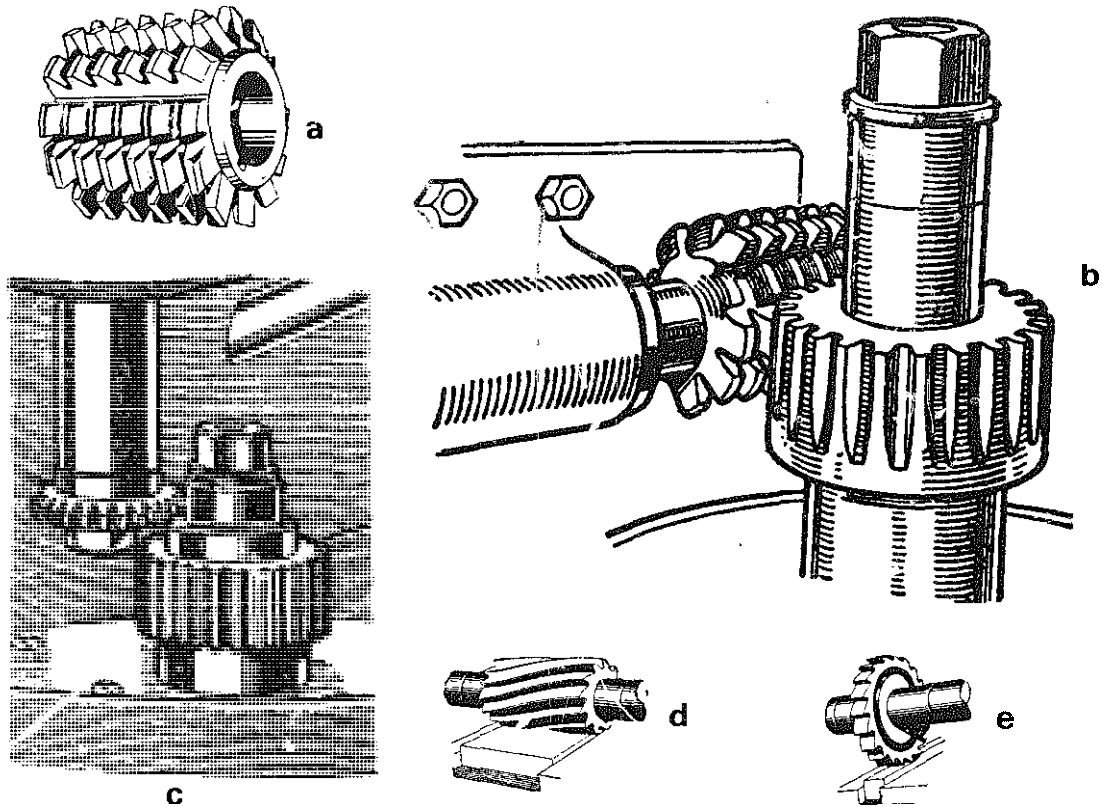

A--Tools

5--SAWS AND SAWING

a-Hydraulic cold saw; it is driven by a separate motor and is fed into the metal by hydraulic pressure.

b - Hydraulic metal saw; hydraulic power clamps the work and also actuates the feed of the saw as it cuts its way through the work.

c--Back saw for metals in correct position for cutting.

d--Back saw.

e--Teeth of a cross-cut wood saw.

f--Teeth of a rip wood saw.

g--Teeth of a rip saw.

h-Side view of "g."

j-Schematic sketch of a band saw, with front plate of unit removed.

k-Compass saw,

l-Flooring saw.

m-Pattern maker's saw.

n-Dovetail saw.

p-Keyhole saw.

q-Bench or joiner saw.

r-Slitting saw.

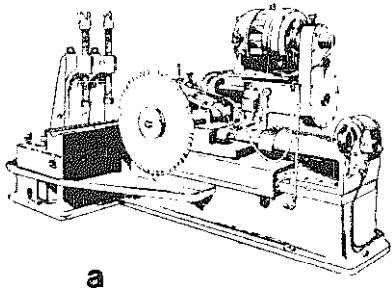

a

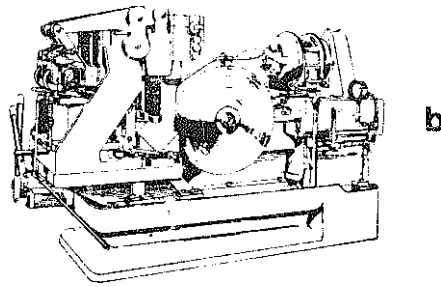

b

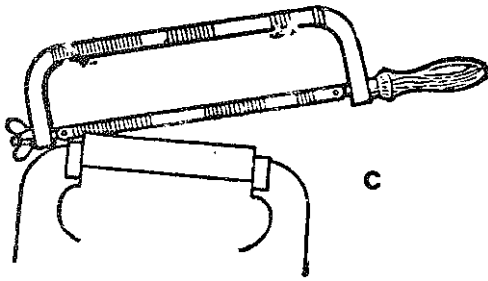

c



d



e

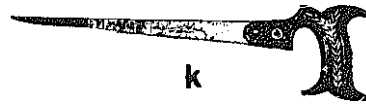

k



f

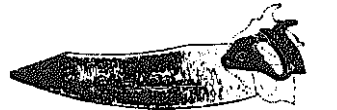

l



g



m



h

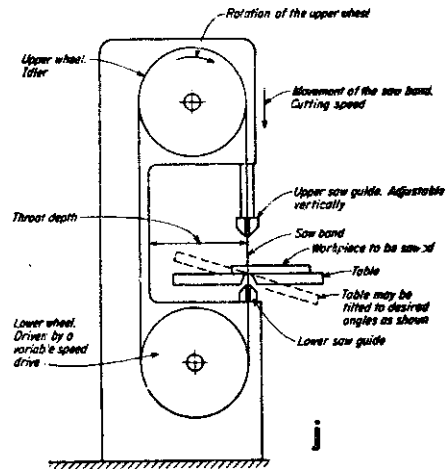

j



n



p



q

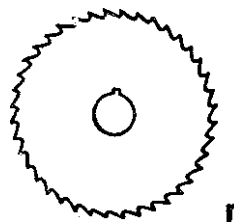

r

A—Tools

6—MISCELLANEOUS

a—Oxy-acetylene torch for cutting steel.

b—Earth borer or mooring screw.

c—Auger, hand operated, to take soil samples.

d—Diamond rock drill.

e—Boring tool to take soil samples.

f—Tools for hand riveting.

g—Magnetic chuck. To hold magnetic parts on the surface grinder. Turning the lever on the side, actuates the electro-magnet.

h—Magnetic parallel blocks, to hold small work.

j—Template used as a file guide for work with irregular profile. A, work piece; B, template; C, locating pins.

k—Side view of “j.”

l—Compound sliding table, used with gage blocks to locate holes for drilling etc.

m—Shell-reamer with helical flutes.

n—Breast drill, with two speed drive (dated).

p—Ham&grinding of drill.

q—Handgtinding of drill.



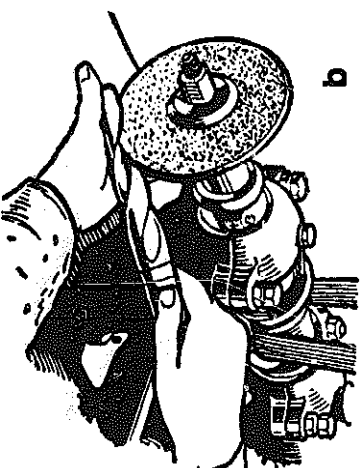
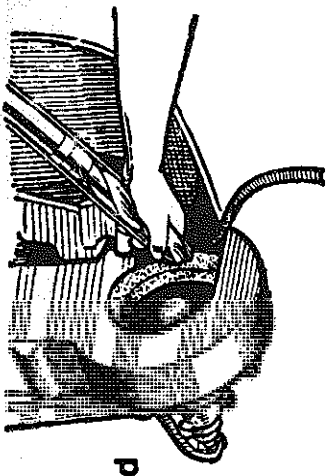
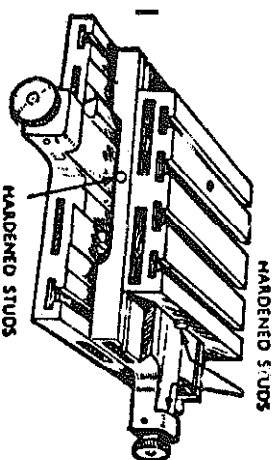
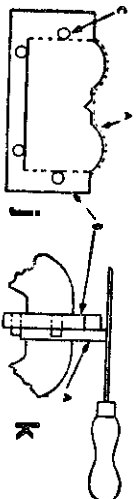
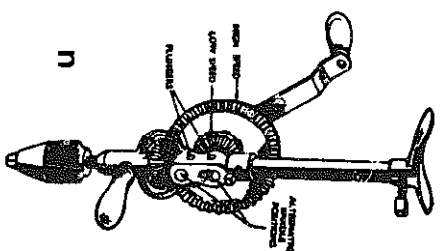
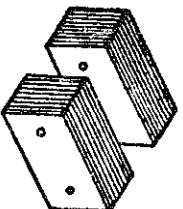
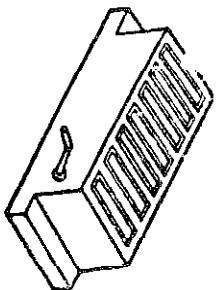
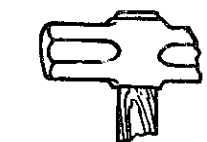
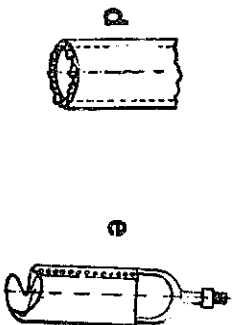
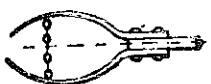
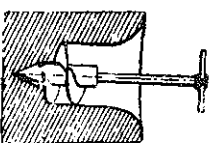
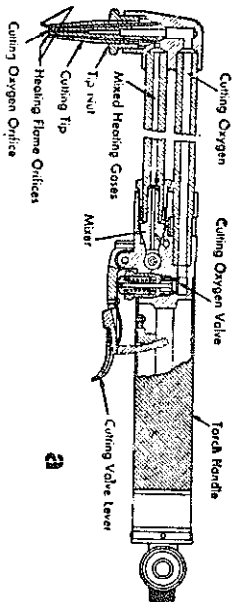

**B-Machinery**

**1-LATHES**

**a - Lathe.** The lathe is used for turning of cylindrical work, and is the most used machine in most shops.

**b-Rear view of lathe apron.**

**c-Compound tool rest for a lathe.**

**d-Design of a tail stock of a lathe.** Shown is the handwheel for moving the dead center.

**e-Small selection of tools that may be used with a lathe.**

**f-Live center for lathe.**

**g-Saddle type universal turret lathe.** 1, start, stop, reverse lever; 2, three-scroll chuck; 3, square turret; 4, rear cross slide; 5, hexagon turret; 10, wheel for hand traverse of saddle and indexing hexagon turret; 12, turret power feed lever; 13, dial feed selector; 14, carriage; 16, carriage hand traverse wheel; 18, single lever dial speed selector. (Former Jones & Lamson design.)

**h-Forming tool for lathe.**

**j-Knurling tool.** Shown knurling knob.

**k-Collet in spindle of lathe, holding bar.**

**l-Cutting a taper on a lathe.**

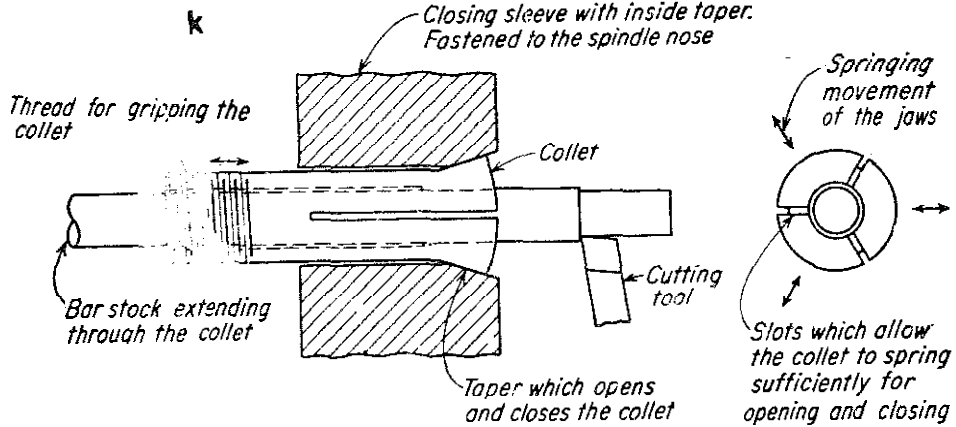
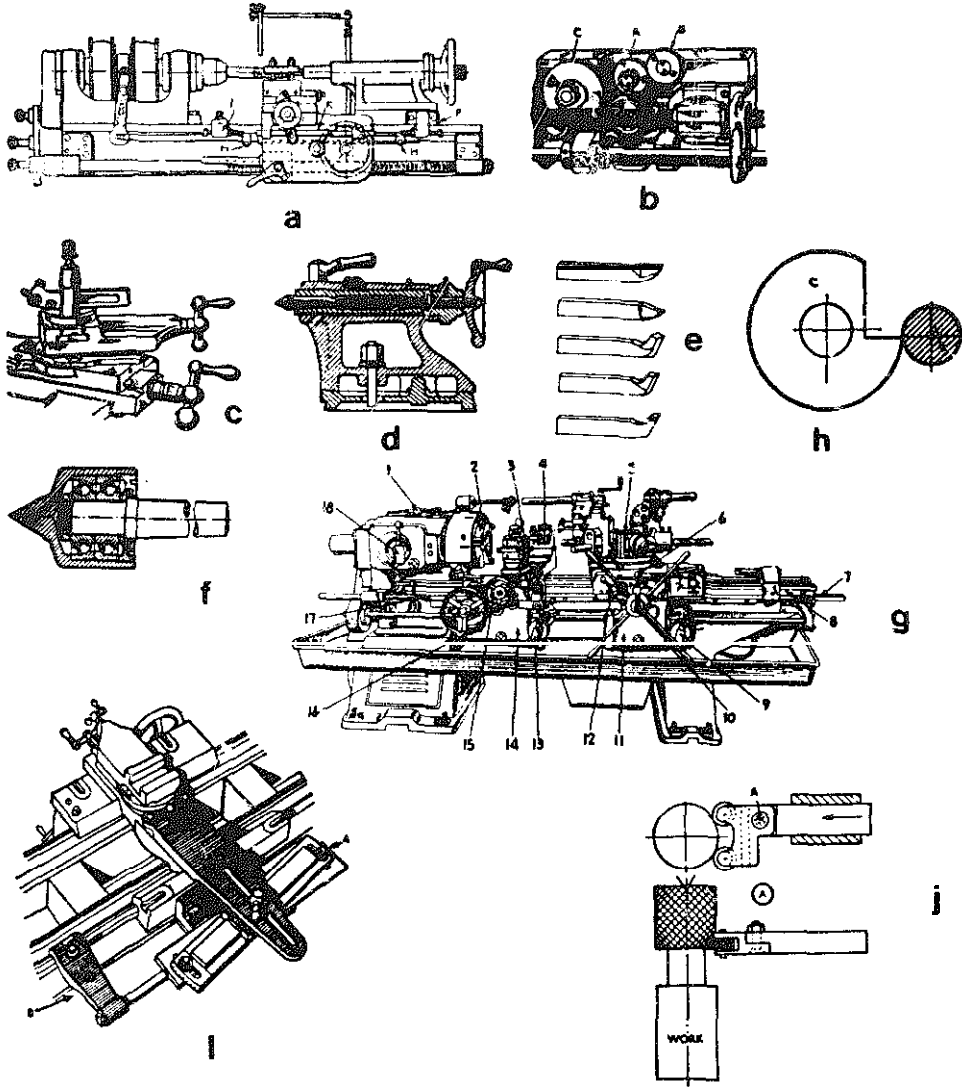

## B—Machinery

### 2—MILLERS

**a-Universal Milling machine.** This older model has been chosen, because it clearly shows the workings of a miller. 1, speed selection lever (hi-lo); 2, spindle reverse lever; 3, speed change lever; 5, starting lever; 6, universal spiral index centers; 7, directional longitudinal feed engagement lever; 8, table clamp; 9, transverse and vertical feed lever; 11, knee clamped from operating position; 12, transverse and vertical adjustment handwheels; 13, oil sight indicator; 14, change gears for universal spiral index centers; 17, feed change lever. (Brown & Sharpe)

**b-Formed milling cutter** (convex) for arbor mounting.

**c-Formed milling cutter** (concave) for arbor mounting. (See chapter on milling cutters.)

**d-Up-milling.** In up-milling the material removed starts with a minimum thickness, and ends up with a maximum thickness.

**e-Down-milling.** In down-milling, the material removed starts with a maximum thickness, and ends up with a minimum thickness. (Climb milling.)

**f-Straddle-milling,** using three cutters.

**g-Vertical milling machine.** 1, speed change lever; 2, starting lever; 3, spindle feed handwheel; 4, spindle head; 5, stops; 6, spindle slide clamp lever; 8, spindle back gear lever; 9, high-low lever; 11, directional longitudinal feed lever; 13, transverse and vertical feed reverse lever; 16, transverse and vertical adjustment handwheel; 20, lever controlling change in feed. (Brown & Sharpe)

**h-Milling cutters in action.** This is not a typical set-up.

**j-Universal dividing head set for differential indexing.** A, indexing spindle; B, index plate; C, crank arm; D, work spindle.

**k-Dividing table.** A, table; B, vernier; C, base; D, pivot.

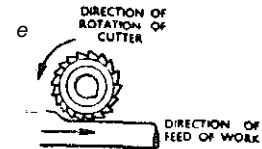
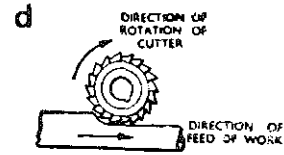
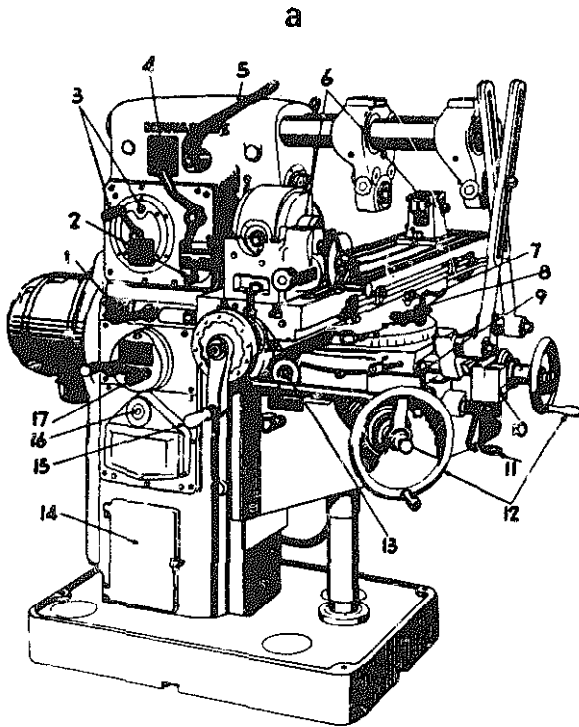

Distance between the side milling cutters adjusted to machine dimension "A" within its tolerance

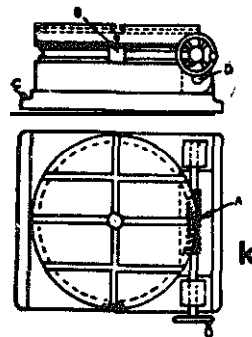
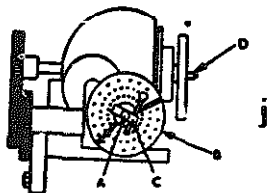
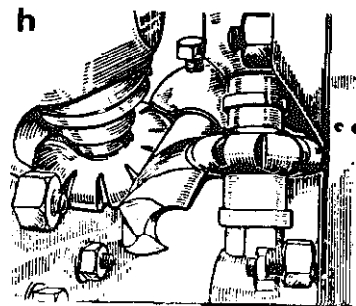
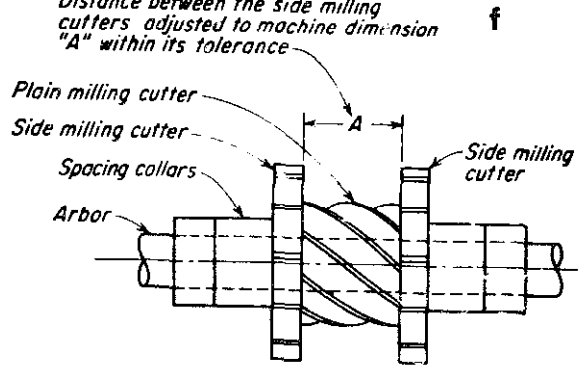
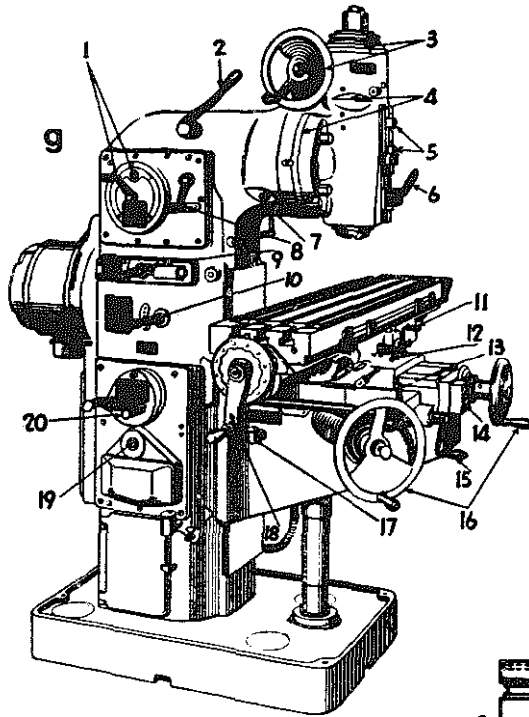

## B-Machinery

### 3-GRINDERS

**a-Grinding machine.** This model has been chosen for clarity of function. 1, knob for headstock and coolant pump; 2, adjustable head stock; 3, start knob for hydraulic table movement; 4, table reversing lever; 8, adjustable footstock; 9, main start-stop push button; 12, index dial; 13, crossfeed handwheel; 14, lever to engage automatic cross feed; 16, crossfeed control knob; 17, knob controlling period of travel dwell; 20, table handwheel; 21, table reversing and positive stop dog. (Brown & Sharpe)

**b-Principle of centerless grinding.** The part is passed between high speed grinding wheel and slow speed regulating or control wheel. The work rest plate or support, carries the work to the wheels and carries it away again, because the regulating wheel is tilted at a slight angle. The work piece rotates with the surface speed of the regulating wheel.

**c-Principles of cylindrical grinding.** The cylindrical workpiece is rotated between centers. The grinding wheel grinds the work piece while the table traverses back and forth. At the end the wheel is automatically fed in for the new depth of the cut.

**d-internal grinding.** A, wheel; B, spindle; C, wheel sleeve; D, work; E, coolant; F, wheel headstock; G, table.

**e-Planetary internal grinding.**

**f-Grinding with a magnetic chuck.** A, grinding machine; B, magnetic chuck; C, work piece; D, grinding wheel; E, guard; F, clamp; G, control handle; H, handle on grinding machine.

**g-Mounting of grinding wheel.**

**h-Straight grinding wheel.**

**j-Flaring cup grinding wheel.**

**k-Cylinder type grinding wheel.**

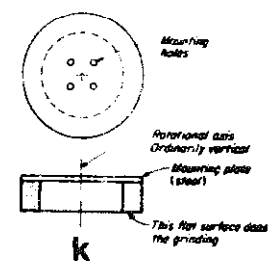
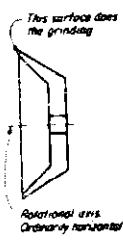
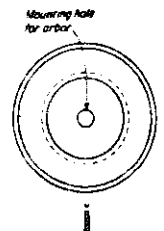
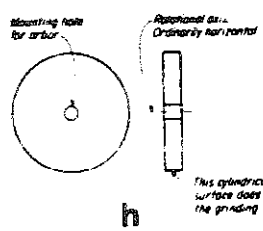
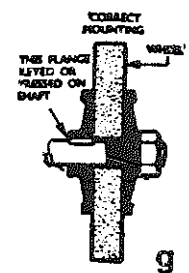
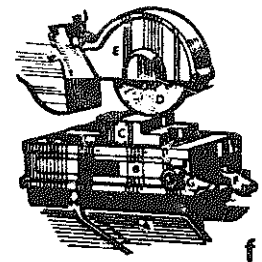
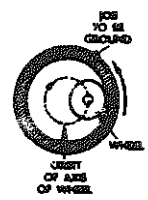
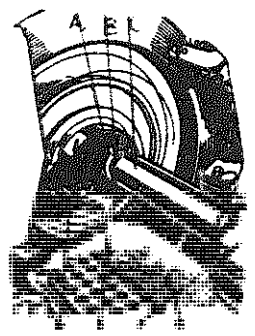
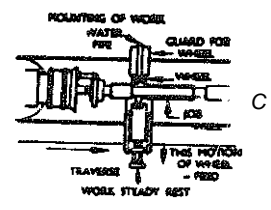
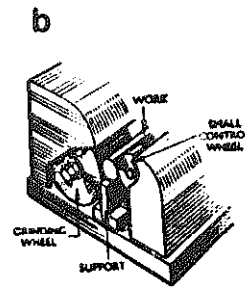
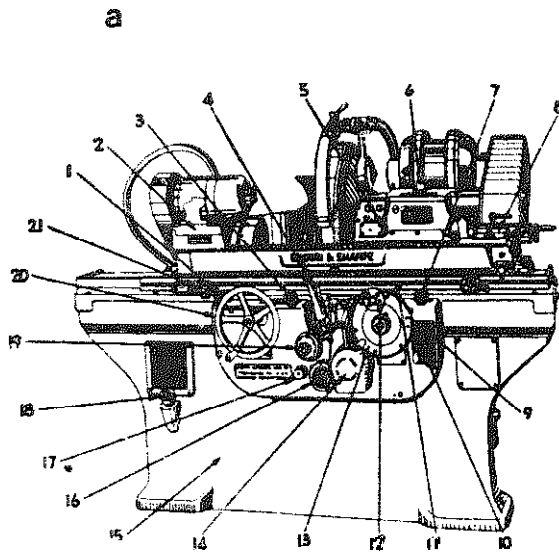

## B—Machinery

### 4—PRESSES

a—**Inclinable power press.** A, lock nuts; B, clamp nut for punch; C, clutch pedal; D, brake; E, knock-out bar; F, bolster plate; G, brake adjustment; H, tie bar lugs.

b—**Punch and die** for punching bolt holes. A, punch; B, press ram; C, die; D, die base; E, taper-gib; F, stripper plate.

c—When **blanks** are to be punched from strip material, the lay-out should save material.

d—**Drawing.** Shown work piece in the middle of a drawing operation.

e—**Blanking and drawing die** for single action press. Strip of material goes across die A. Descending punch B, cuts blank. Punch continues downward, so blank is between B and pressure pad C, pressure being applied between D, studs E, and C. Blank is drawn to shape between block F and inside of punch B.

f—**Set-up for double action press.** A and B are two punches, each fixed to its own ram. Punch B descends first, cutting the blank into the die, C, and stays there while holding the blank at the required pressure. Punch A now goes into action, drawing the blank into die D.

g—**V-bending die.** A, die; B, locating gage plate.

h—**Double bending die.**

j—**Curling die.** A, die; B, punch with curling form X; C, ejector. D, work piece, sticking out from die enough for curling.

k—**Coining die.** A, punch; B, ejector; C, die.



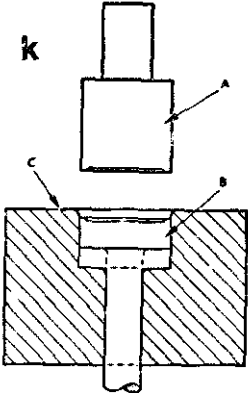
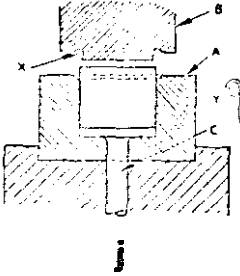
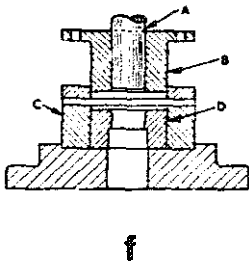
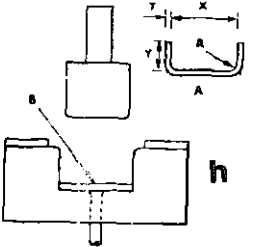
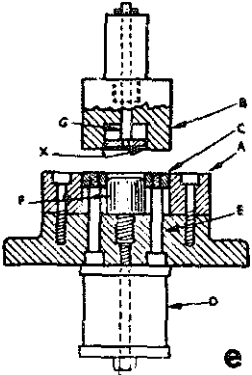
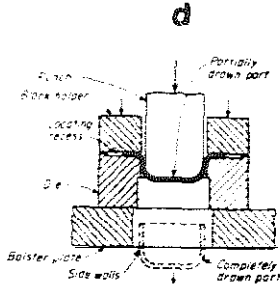
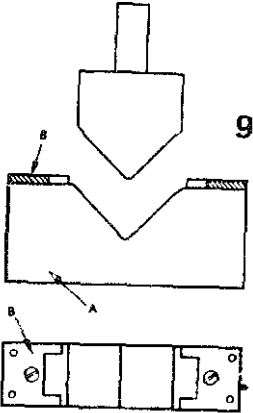
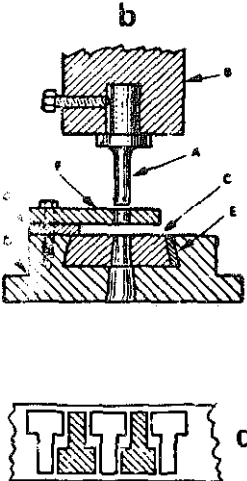
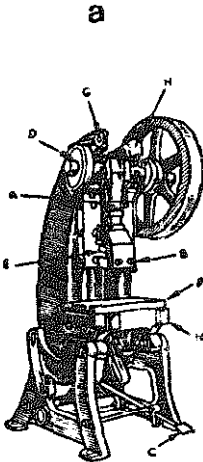

B--Machinery

5--SHAPERS AND PLANERS

a--Shaper, mechanically driven. This illustration shows the typical quick return motion of the shaper. 1, toolpost; 2, clapper box; 3, head; 4, ram adjuster; 5, ram clamp; 6, ram; 7, column; 9, gear shift lever; 10, back gear shift lever; 11, stroke adjuster; 12, feed adjuster; 13, base; 14, feed rocker arm; 15, feed box; 18, table support; 20, saddle; 22, vise. (Old model of American Machine Tool Company.) Note: for hydraulic driven shaper see chapter on *Fluid Technology*, section E-2.

b--Cutting action of tool in advancing ram.

c--Basic mechanism of mechanically driven shaper, like "a."

d,e,f--Typical cutting tools for shaper and planer.

g--Planer. A planer is designed to machine large plane surfaces. A big table, carrying the work piece, reciprocates under one or more fixed tools. 1, power elevation unit for rail; 2, adjustable control for main motor; 3, motor control; 4, trip dogs; 5, control cabinet; 6, feed friction for rail and side heads; 7, control for power feed and rapid traverse to rail heads. (Former model of Ohio Machine Tool Co.)

h--correct toolposition for planer.

j--Planer in action.

SHAPERS & PLANERS

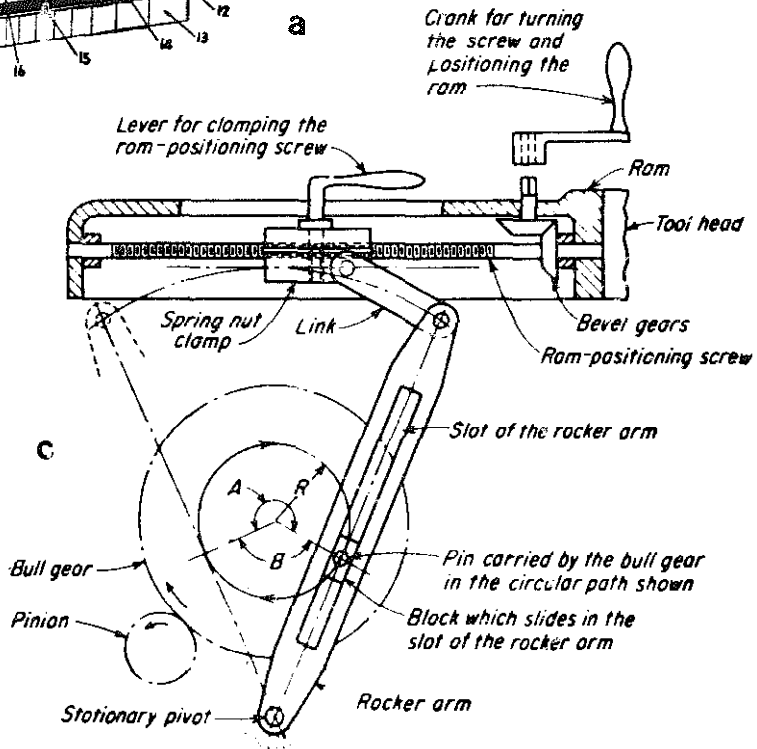
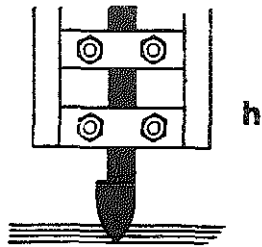
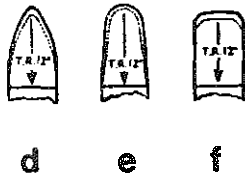
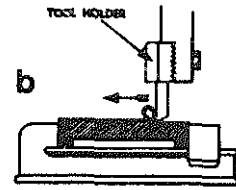
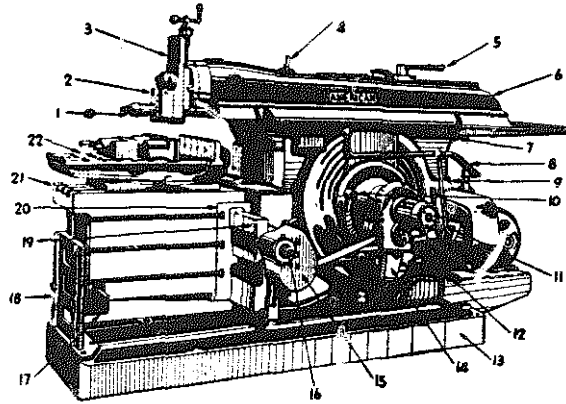

Crank for turning the screw and positioning the ram

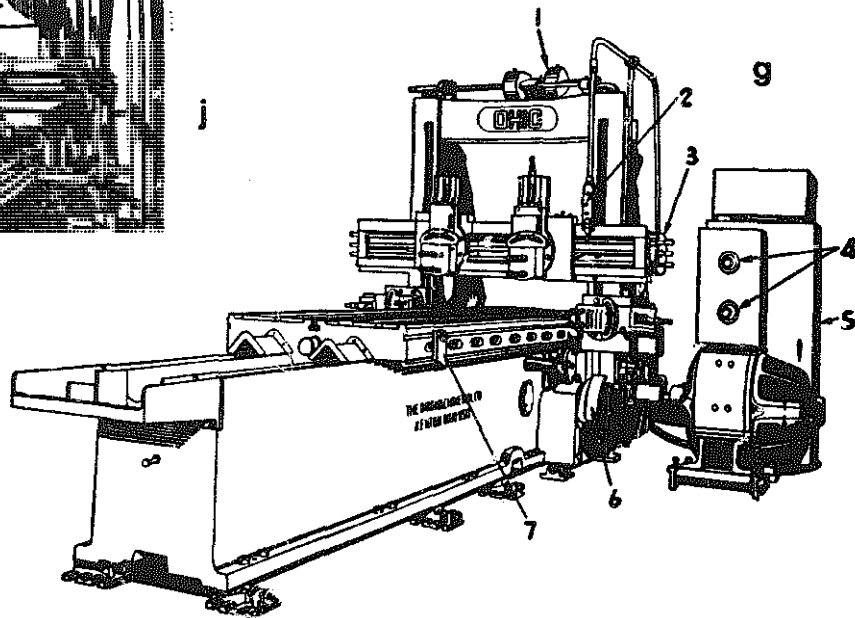
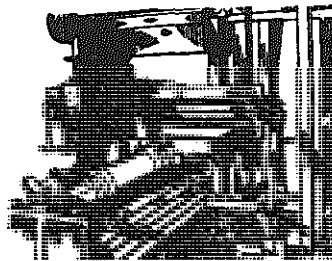

B—Machinery

6—MISCELLANEOUS

**a-Portable pneumatic drill.**

**b-Electric hand drill.**

**c—Engraving machine.** Any kind of material can be engraved, from plastics to steel. Also irregular surfaces and cylindrical surfaces may be engraved.

**d-Spot-welding machine.** Pedal shown brings the electrodes together.

**e—Equipment for oxyacetylene welding.** G, oxygen cylinder; H, acetylene cylinder; A and C, high pressure gages; E and F, stem-type single stage pressure reducing regulators; D and B, low pressure gages; J, torch.

**f-Soldering blowtorch.** section 1, basin; 2, adjuster; 3, burner nipple; 4, regulator; 5, tube; 6, guide for regulator screw.

**g—Flame of blow-pipe.**

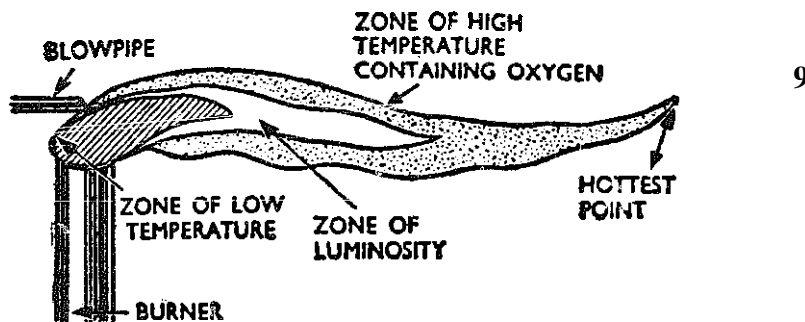
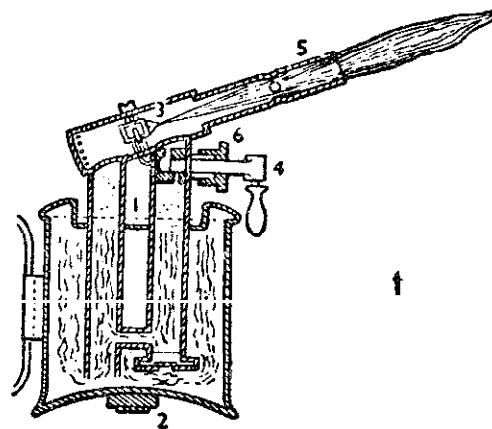
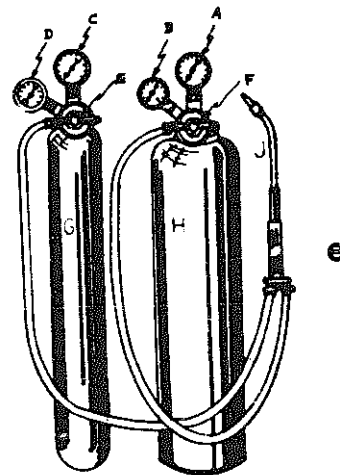
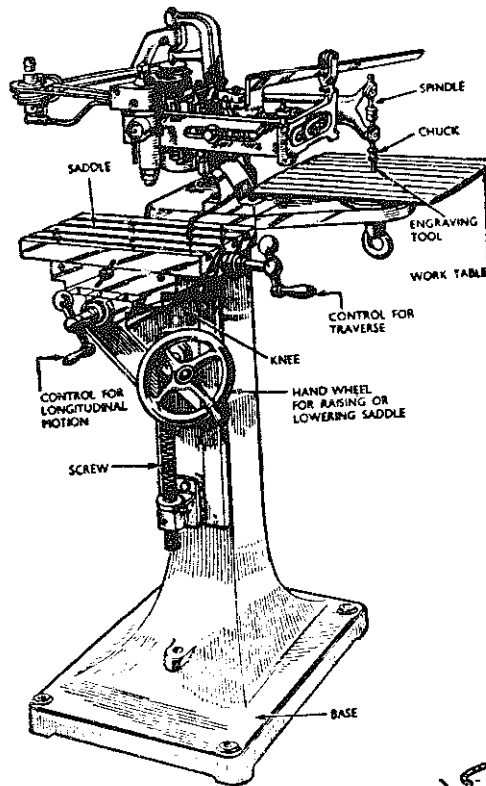
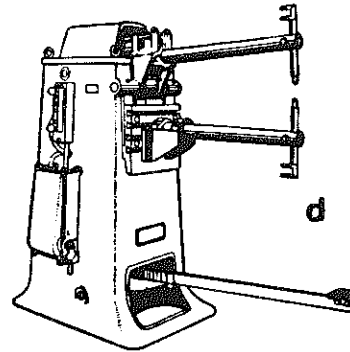
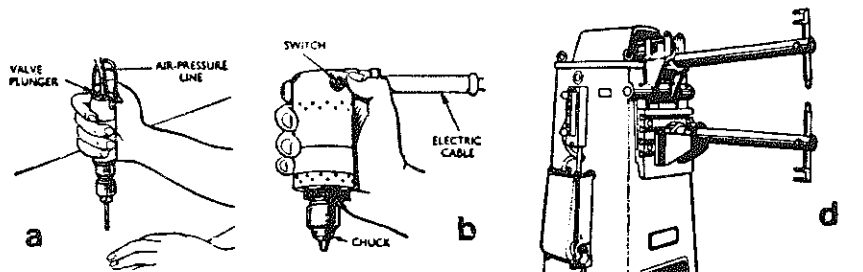

B—Machinery

7—AGRICULTURAL MACHINERY

a-Spanish plow ( 1708).

b-Daniel Webster's plow ( 1836).

c—Chilled p l o w with reversible point; made of cast iron; designed by Oliver.

d-Sulky plow (1910).

e -Reversible or hillside plow, for use where the land is too sloping to throw the furrow-slice uphill.

f-Disc plow for horse or tractor power.

g--Disc engine gang.

h-Spike-tooth harrow.

j-Weeder for killing young weeds.

k—Curved knife-tooth riding harrow, clod crusher and leveller.

l-Spading-disc harrow.

m—Orchard-disc barrow; it has a wide frame for work under trees.

n—Smooth iron roller.

o—Corrugated roller.

p -Riding cultivator with eight shovels; it has a hammock seat and balance frame.

q-Disc cultivator.

r—Original Campbell combined cultivator and grain drill.

s—Potato planter in cross-section.

t-Potato digger; high-elevator type.

u-Potato digger; low-elevator type.

AGRICULTURAL MACHINERY

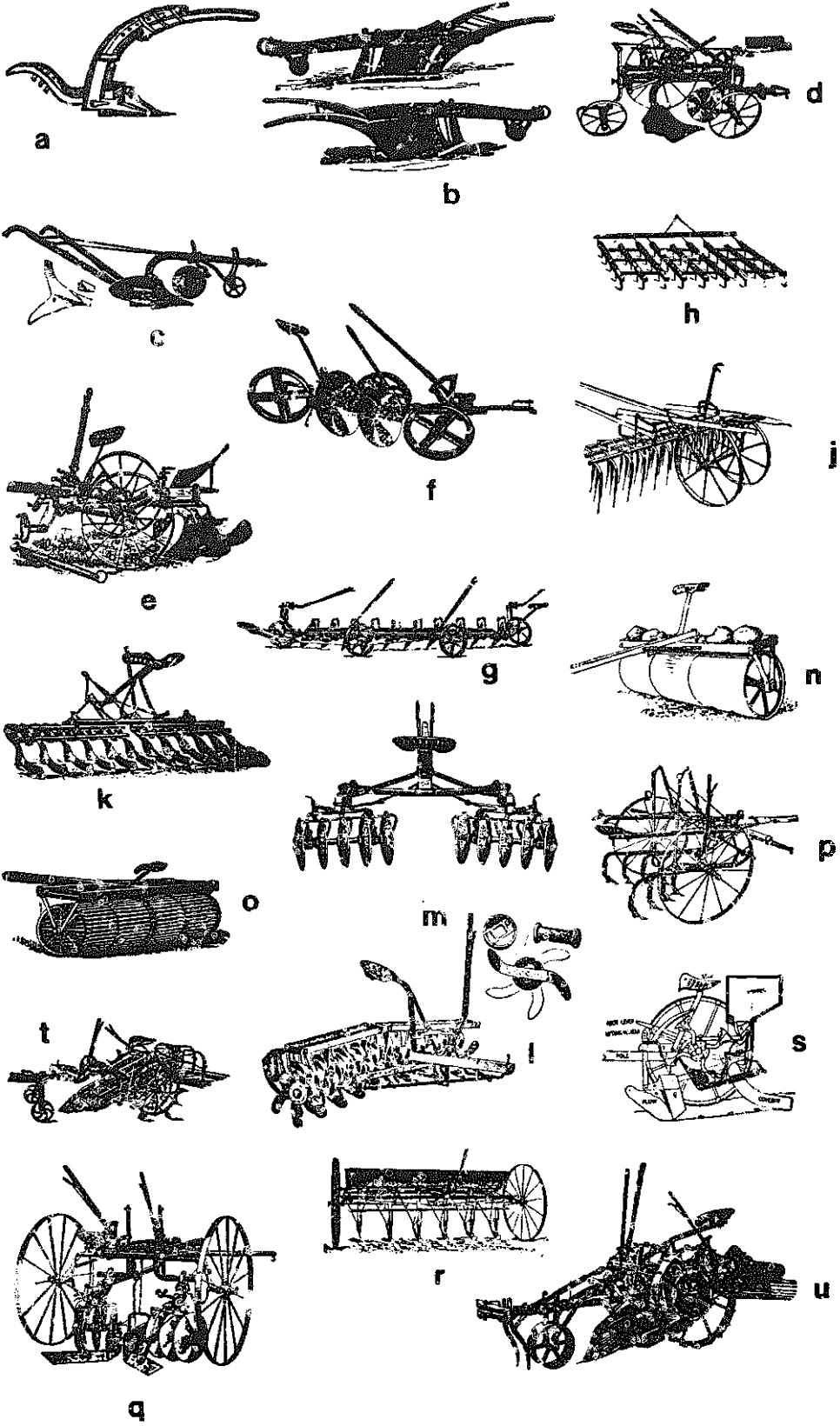

**C-Fabrication Methods**

**1-CHOPPING, SLICING AND MINCING**

**a-Wire-bending** and cutting machine

**b-Disc cutter** with radial knives and slots; it is used for vegetable fibers, roots, stems, etc.

**c-Revolving cutter rollers.**

**d-Disc cutter** with small knives wedged in separate holes through which cuttings escape in shreds.

**e-Single-roller revolving cutter.**

**f-Spiral tapered** revolving cutter; common mincing machine.

**g-Revolving spiral** cutter; lawn mower.

**h-Two or more rectangular cutters**, with vertical reciprocating motion in a revolving pan for mincing.

**j-Apple slicer and corer:**

**k-Machine for slicing roots**, etc.

**l-Mill for chopping or grinding**; it contains two rollers driven at different peripheral speeds.

**m-Hand mincing compound knife.**

**n-Bark or cob mill.**

**p-Disc shears.**

**q-Hollow chuck** with radial knives for rounding off wooden rods.



CHOPPING, SLICING & MINCING

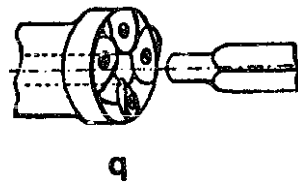
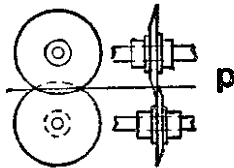
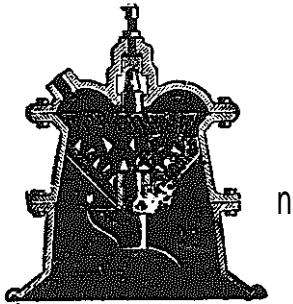
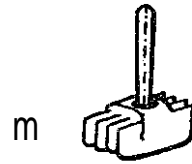
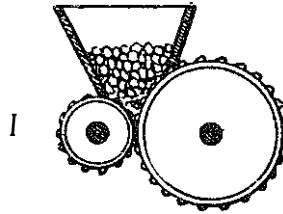
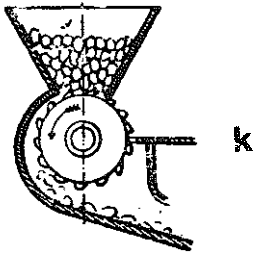
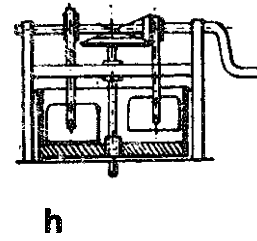
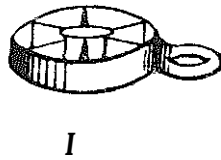
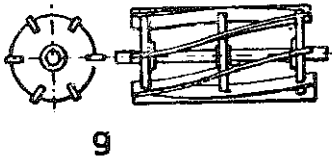
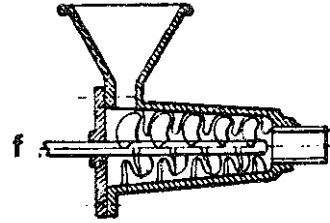
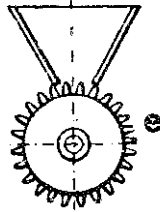
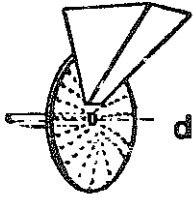
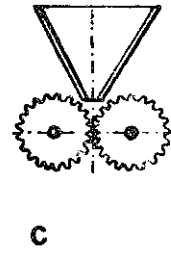
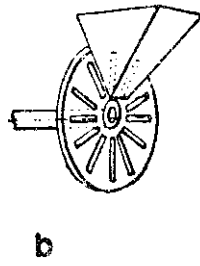
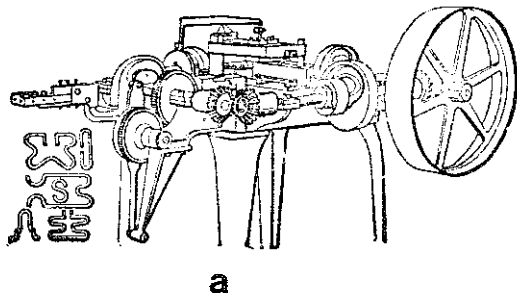

C-Fabrication Methods

2-CRUSHING AND GRINDING

**a-Conical mill** and loop classifier; the material is fed into the mill by a constant-weight feeder; the ground material is removed from the mill as soon as ready; 3 separations from 20 mesh to as fine as 99.9%-325 mesh; 4 oversize particles are returned to the feed end of the mill; 5 the product is discharged at any elevation; 6 the fan returns clean air to the mill; 7 small amounts of air and vapor are vented; 8 "electric car" sound-control unit maintains maximum capacity. (Hardinge)

**b-Stone breaker** with toggle motion.

**c-Vertical cone mill.**

**d-Revolving stamp** and pan mill for ores.

**e-Revolving pan** and ball mill.

**f-Crushing rollers** with spring bearings.

**g-Eccentric-disc grinding mill.**

**h-Cone-roller mill.**

**j-Double-edge runners;** in some type the rollers revolve, in others, the pan revolves.

**k-Toothed-sector mill.**

**l-Centrifugal pulverizer.**

**m-Cylindrical bail mill.**

**n-Two-roll coal crusher.**

**p-Barrel finishing.** A process designed to remove burrs, edge roughness, and surface irregularities from bulk quantities.

**q-Horizontal centrifugal roller mill.**

**r-Concrete mixer.**

**s-Ball mill** for grinding various materials.

**t-Lens grinder.**

**u-Stamp mill.**

CRUSHING AND GRIND

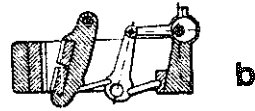
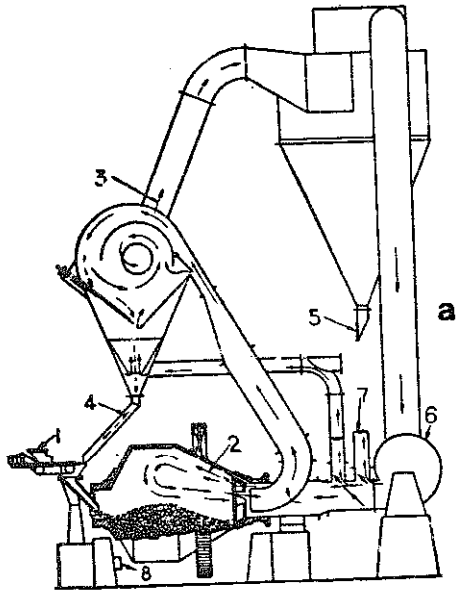

b

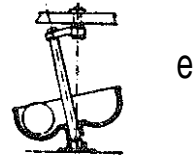

e

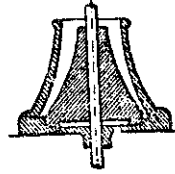

c

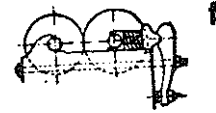

f

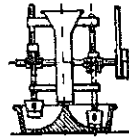

d

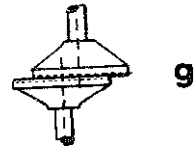

g

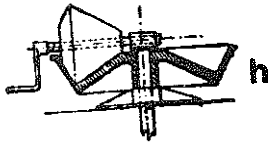

h

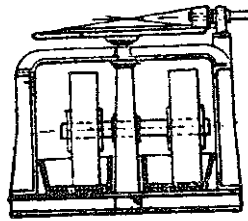

i

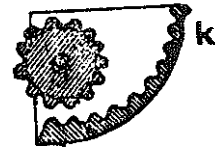

k

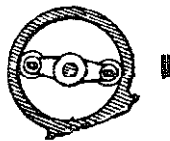

l

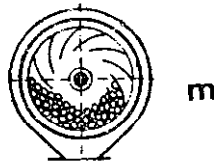

m

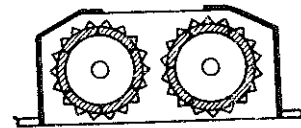

n

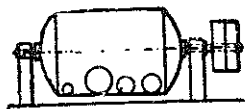

p

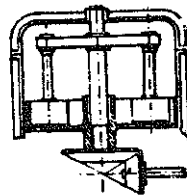

q



r



s

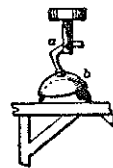

t

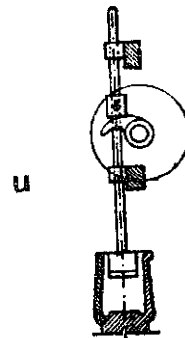

u

C-Fabrication Methods

3-SIFTING, SCREENING, STRAINING

a-Square-mesh wire gauze.

b-Perforated plate with round holes.

c-Parallel bars or wires.

d-Triangular mesh.

e-Hexagonal mesh.

f-Slit-end square-hole perforated plate.

g-Sloping screen.

h-Cylindrical- or slope-reel screen.

j-Cylindrical graduated screen or sizer.

k-Rotary screen, with rolling bevel-gear motion.

**I-Shaking or jiggling screen;** it is sometimes supplied with a blast or aspirator to carry off the lighter particles.

m-Rotary horizontal screen.

n-Eccentric or angular barrel screen or mixer.

o-Air-blast sizing or graduating apparatus.

p-Magnetic sizing apparatus for iron or steel particles.

q-Graduating or sizing screens; fixed, or jiggled like L.

r-Straight through pressure and suction strainer; the cover is removable for lifting out the perforated basket.

s-Cotton gin; *D* nest of saws; *E* saw grate between each saw to hold back the seed; *A* feeder trough and hopper; *J* cylinder brush stripping the cotton fiber from the saw; *F* adjusting lever; *K* sliding mote board.

t-Cyclone collector and separator; wood shavings or other light materials enter the inlet to the fan under suction and discharge into the cyclone at 1; the material rotates around the periphery of the cylinder, drops into the cone, and is discharged at 3; air is vented at 2.

# SIFTING, SCREENING, STRAINING

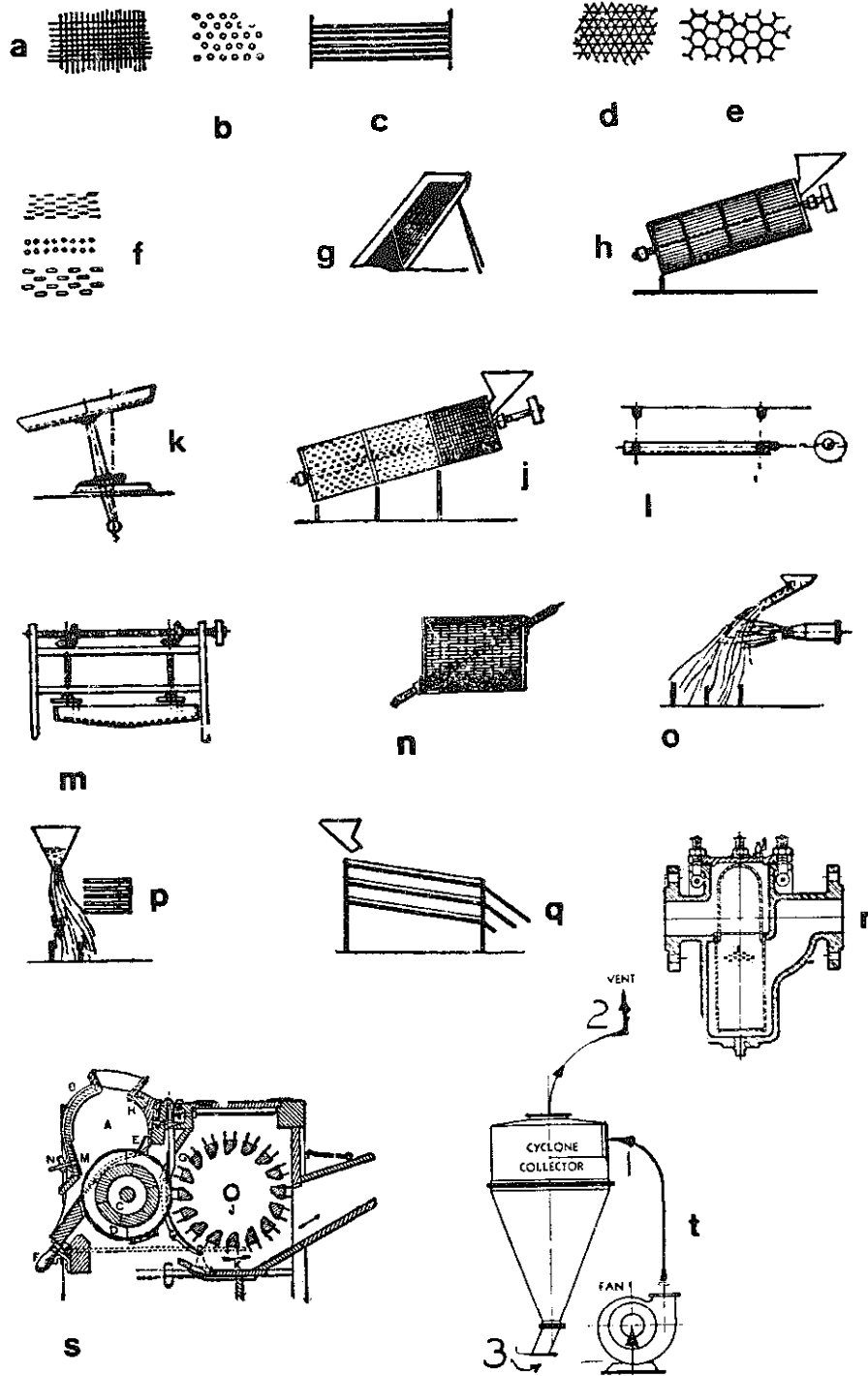

C—Fabrication Methods

4—MIXING

a-Candy mixer operated by a crank.

b-Kneading mill with spiral vanes.

c-Pan mixer.

d-Mixing machine.

e-Dough mixer, or kneading machine.

f-Diagonal mixing pan used in confectionery.

g-Diagonal mixing barrel with fixed and revolving vanes.

h-Mixer with two pairs of arms running in opposite directions; the centers of the arms are above one another so that the arms pass each other in revolving.

j-Egg beater.

k-Horizontal table mixing machine; the material works its way from the center to the edge by centrifugal force.

l-Mixer with two pairs of arms running in opposite directions.

m-conical mixing barrel.

n-Mill with spiral paddles.

o-Pug mill with radial paddles revolving inside a conical case.

p-Concrete mixer.

q-Circulating and screw-impeller mixer.

r-vertical brine agitator in an ice-making tank.

s-Flash mixer for rapid mixing of chemicals. (Link-Belt)

MIXING

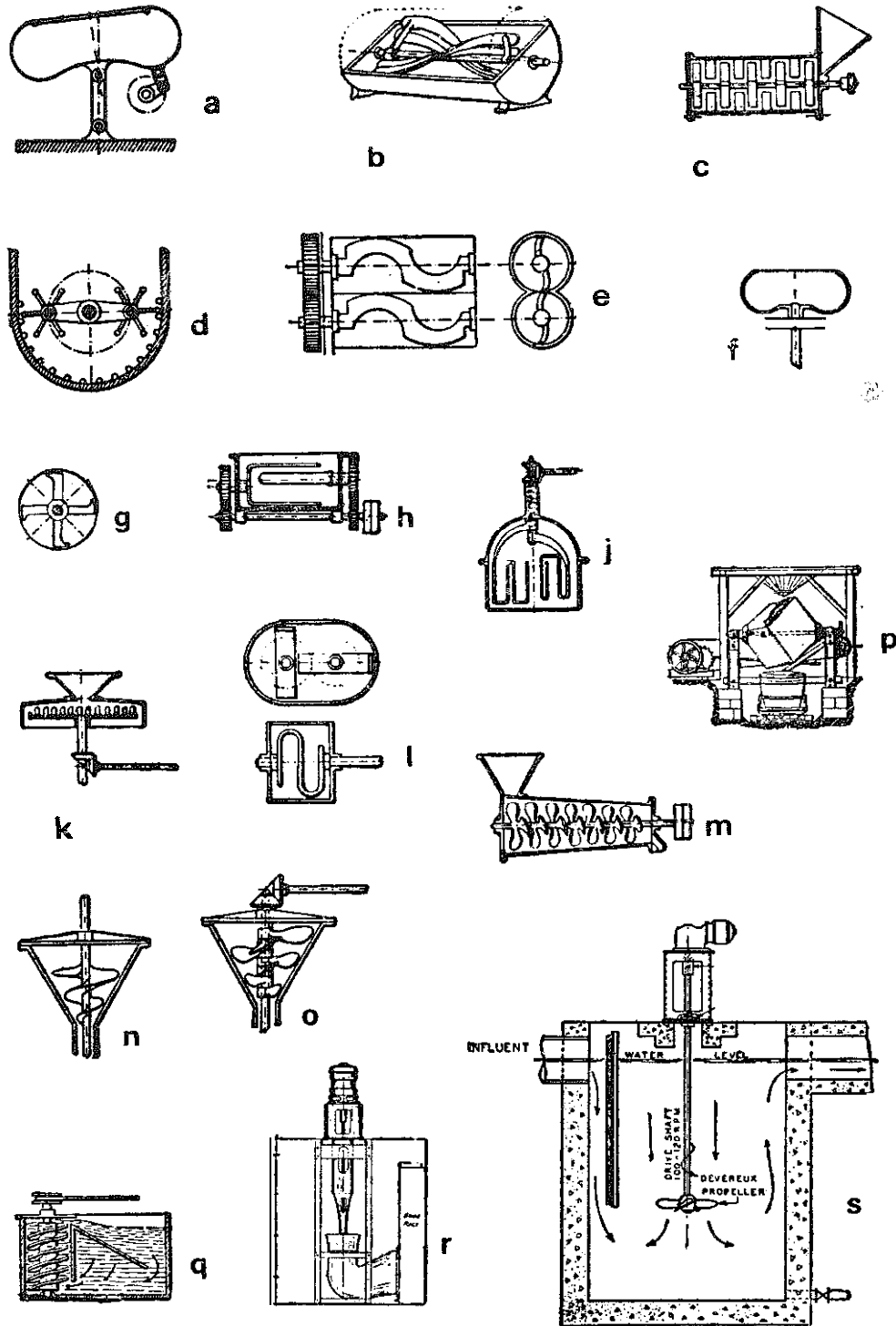

## C—Fabrication Methods

### 5—WASHING AND WINDING APPARATUS

- a—Revolving cylindrical screen washer.
- b—Coal or ore washer.
- c—Archimedean circulator for a washing trough.
- d—Tub and paddle washer.
- e—Cylindrical perforated drum with internal fixed spiral flange which causes the material to travel at a fixed speed; the cylinder may be revolved in a water trough as “a,” or water may be fed in with the material when the casing is unperforated.
- f—Washing device for fabrics with corrugated roller.
- g—Continuous circulator for boiling tubs; the hot water circulates similarly to the operation of a coffee percolator.
- h—Rotary clothes washer; it consists of an internal perforated drum turning in alternating directions inside a vessel containing soap and water.
- j—Water trough and dipping mechanism for washing fabrics.
- k—Drum or barrel for winding wire, rope, etc.
- l—Winding barrel for winches, cranes, etc.
- m—Fusee barrel; it is used to give even tension to spring.
- n—Grooved barrel for winding chain.
- o—Hexagon-frame winder for chain.
- p—Spool.
- q—Cord winder.
- r,s—Bobbins.
- t—Bobbin winder for cotton.
- u—Drum for flat rope.
- v—Fusee for round rope.
- w—Thread feeding by an oscillating arm.



# WASHING & WINDING APPARATUS

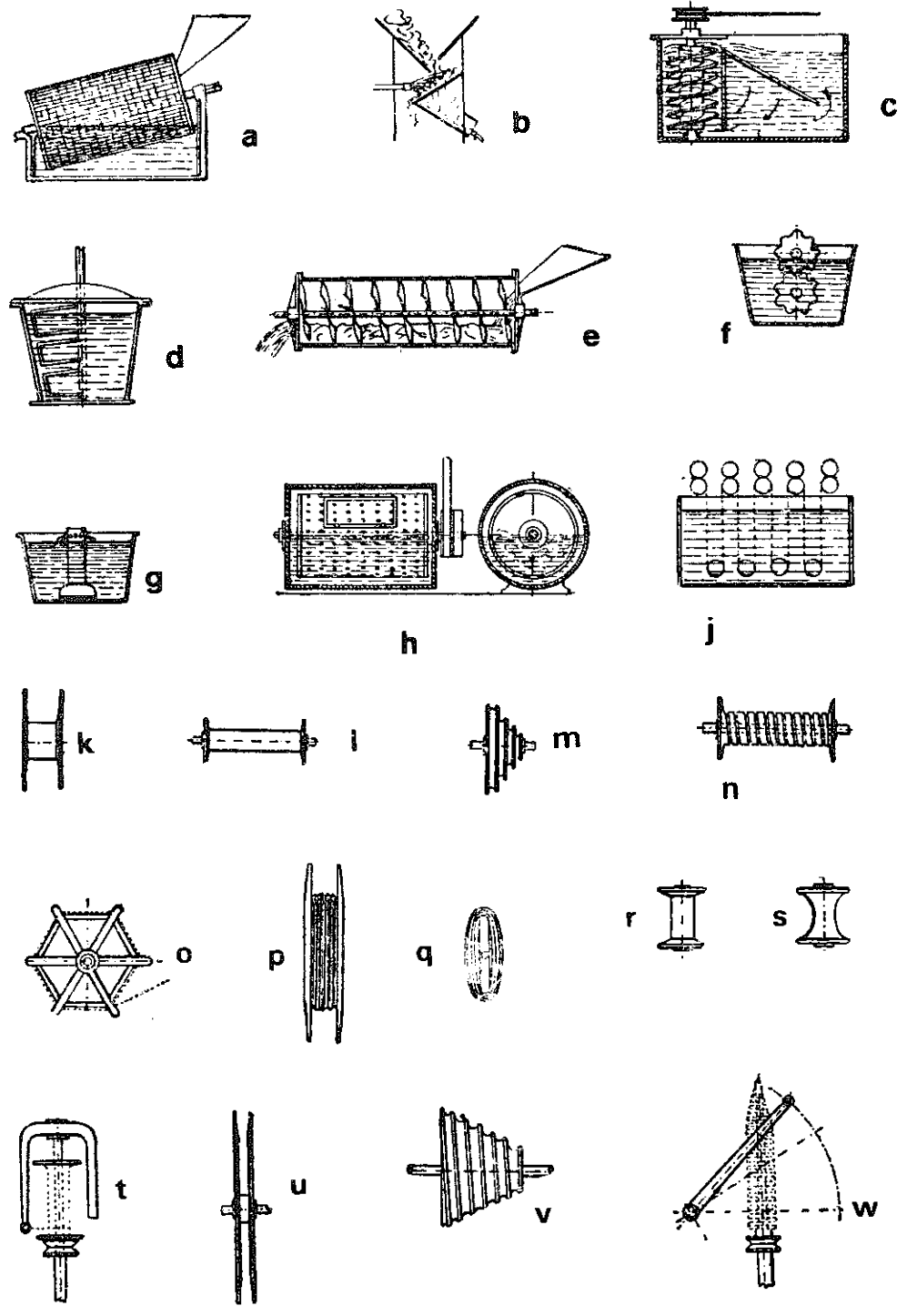

C—Fabrication Methods

6—SMITHING

a—Brick-built blacksmiths' hearth.

b—Power hammer for roughing out heavy forgings

c—Blast fan.

d—English anvil.

e—French anvil.

f—Blacksmiths' tools.

g—Swage block.

h—Dolly.

j—Arrangement of an industrial blacksmith shop.

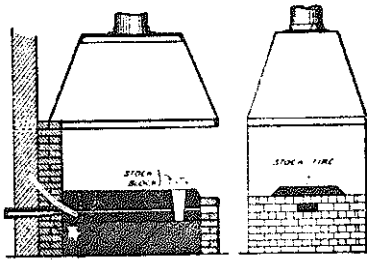

a

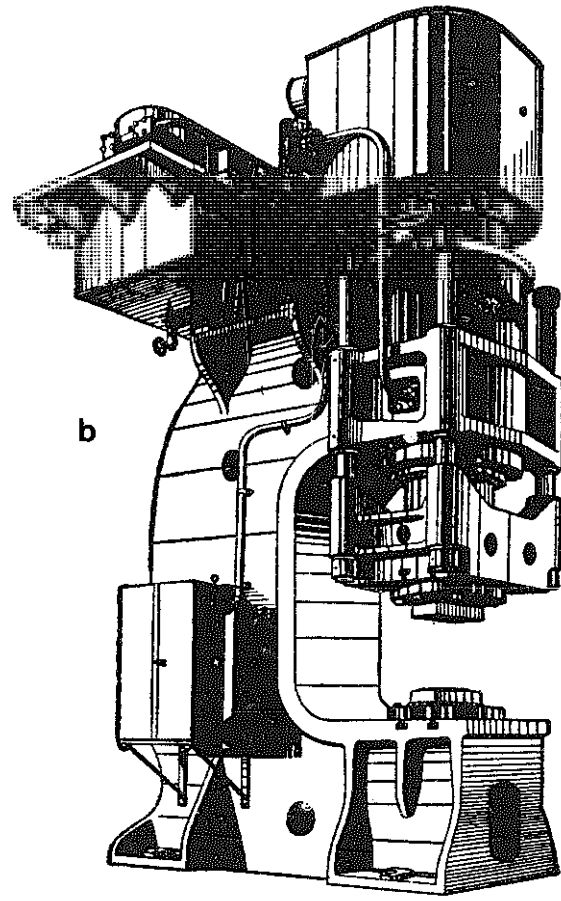

b

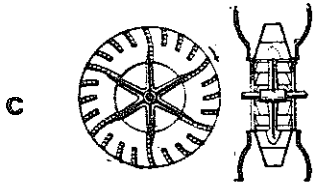

c

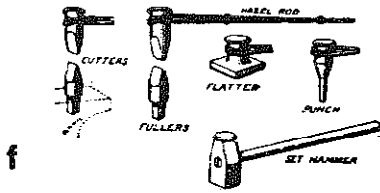

f

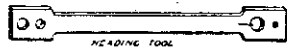

HEADING TOOL



TEARULES



SWAGES



TONGS

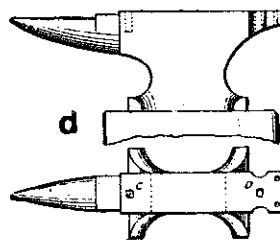

d

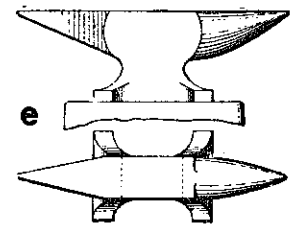

e

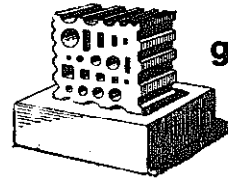

g

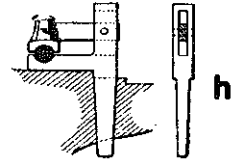

h

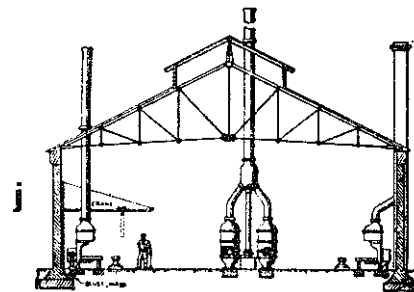
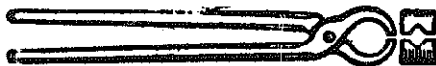
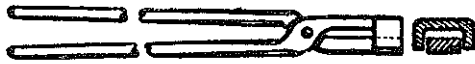

j

C-Fabrication Methods

7-FOUNDRY WORK

**a,b,c,d-Trowels** used for making molds.

**e,f,g-Types of rammers.** "g" is a flat rammer, used for final ramming.

**b-Section through a mold.** On the right side is the pour basin, leading into the gate sprue, the casting and the riser. Metal coming up the riser carries with it loose sand particles, slag etc.

**j-Cross-section through the pour basin.**

**k-(Snap)-flask.** A, locking device; B, hinges; C, pins to hold parts in register; D, slide to take pins; E, grooves to retain sand in flasks.

**l,m-Ladles** used in the foundry, to pour the molten metal into the molds.

**n,p-Loose pieces.** If, due to projections, a pattern cannot be drawn out of the sand, loose pieces must be used. These are detachable from the inserted pattern and are drawn separately.

**q-Matchplate** made by mounting patterns on a flat plate. In use, the matchplate is placed between cope and drag section of a flask.

**r-Jolt-squeeze** molding machine. A, jolt and squeeze table; B, jolt knee valve lever; C, squeeze head arm; D, lever for operating the squeeze head; E, squeeze head; F, pins for lifting box.

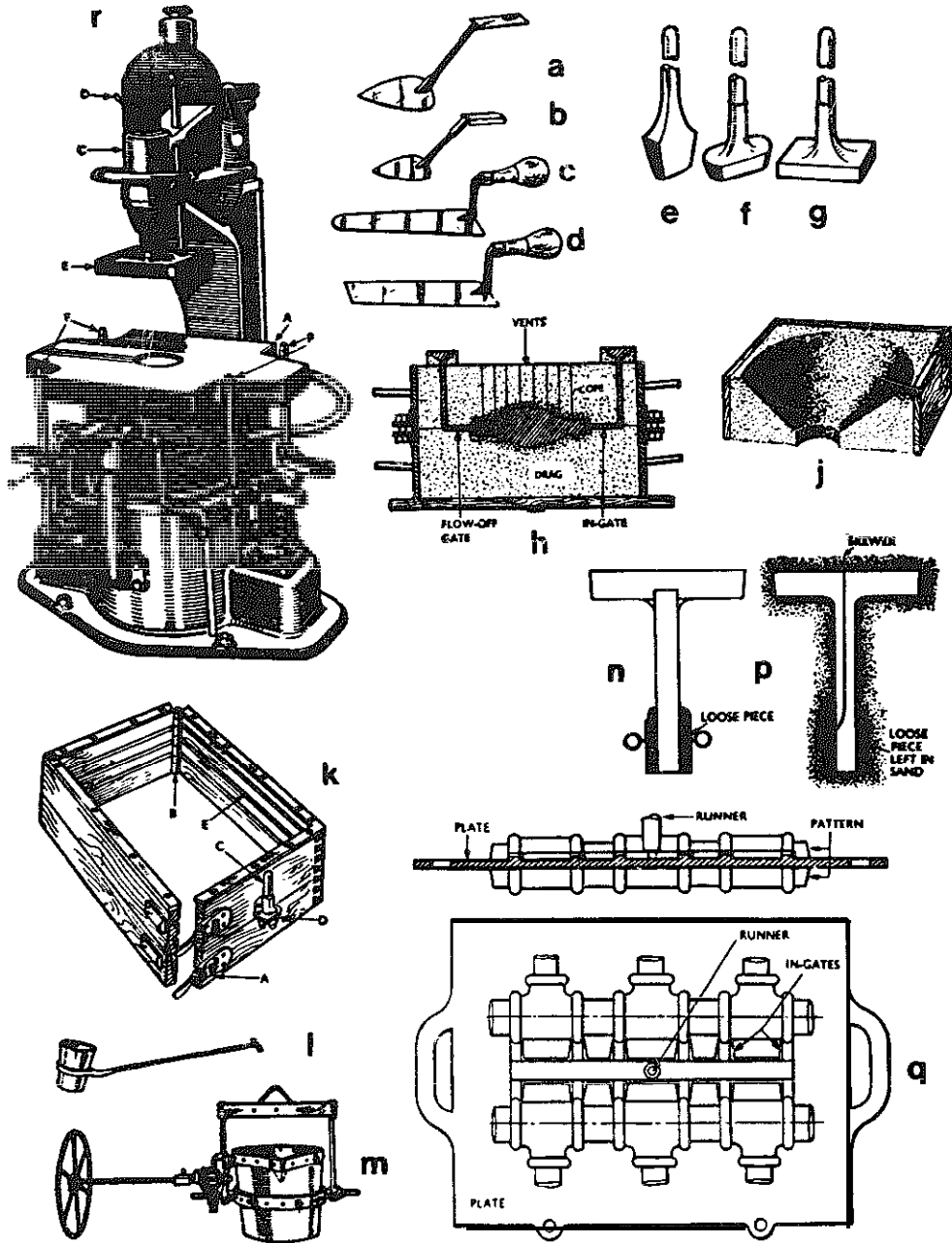

C-Fabrication Methods

8-MISCELLANEOUS

**a-Electroforming**, is closely related to plating. The mold or matrix must be a conductor, and must be removable or expandable.

**b-Grinding** with abrasive belt. (Sander)

**c-Electrolytic grinding**. The rotating wheel is an electrode, insulated from the grinding machine. It is, however, connected to the electric current. Electrolyte is pumped onto the work piece, acting as coolant and cutting fluid. The high electrode speed keeps the electrolyte in the small space between wheel and workpiece. Metal is dissolved from the workpiece, by means of a high current. Abrasive grain on wheel prevents shorts from electrode to work piece, but no contact should occur.

**d-Chemical milling**. Workpiece is submerged into a tank with etchant. All places are etched at the same time. If surface should not be touched, it must be masked.

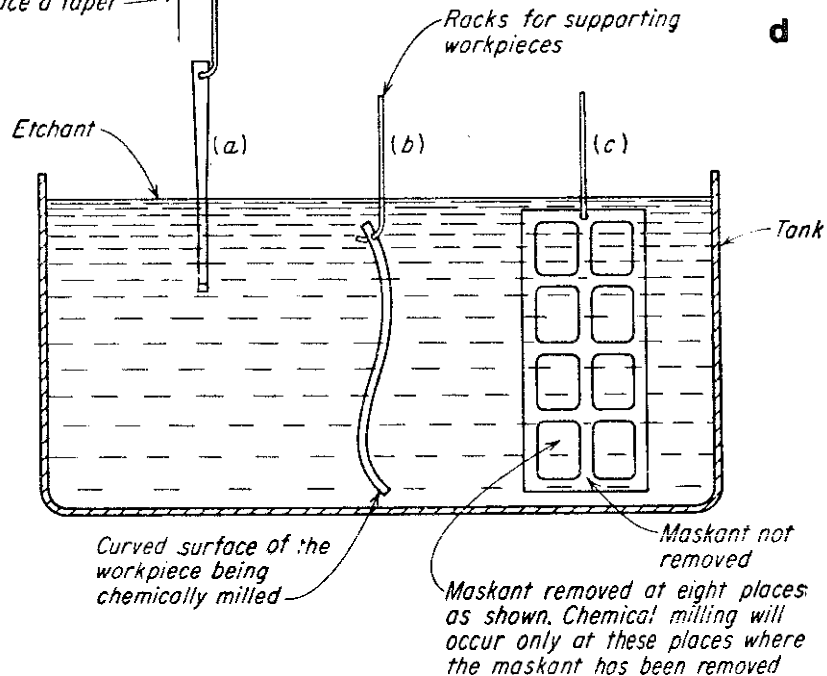
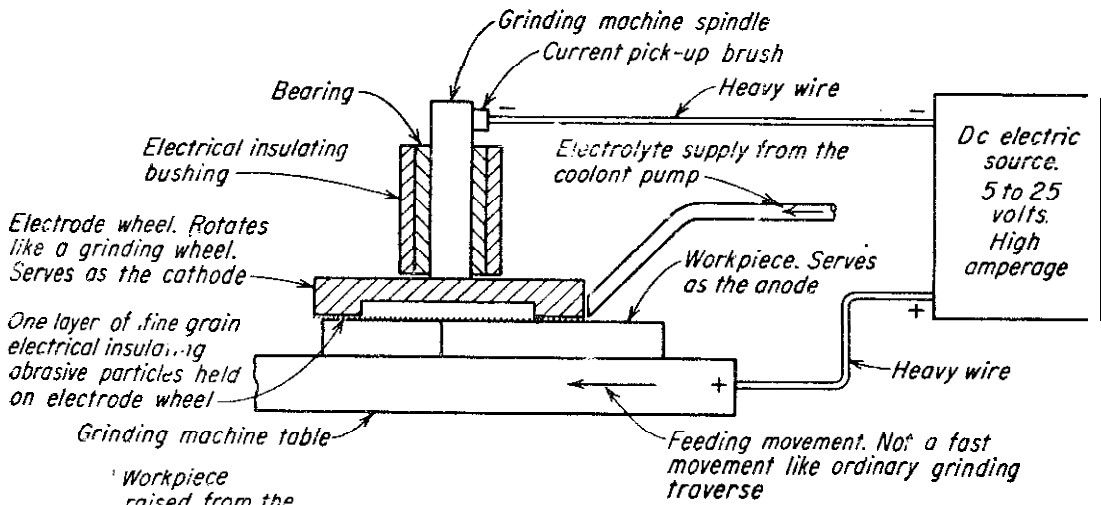
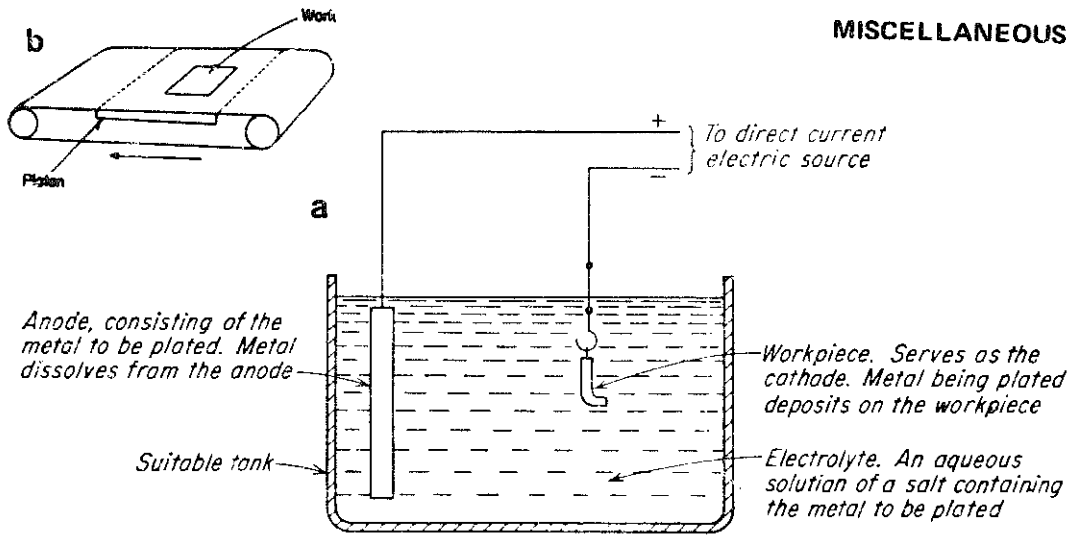

## VI POWER GENERATION



A—Engines

1—STEAM ENGINES

**a—Uniflow engine.** This engine permits steam to enter at the end of a cylinder and leave through exhaust ports located in the middle. This avoids the requirements for the steam to enter and leave at the same end with the associated condensation losses.

**b—Basic steam engine with porting.**

**c—Simple single D slide valve without lap.**

**d—Valve with steam lap and exhaust lap.**

**e—Single D slide valve with double exhaust and steam ports.** Central steam ports open into the steam chest at the side of the valve.

**f—Exhaust valve for Corliss engine.**

**g—Steam valve for Corliss engine.**

**h—Exhaust valve for Corliss engine.**

**j—Typical Corliss valve gear set-up.**

**k—Balanced throttle valve with direct governor connection.**

**l—Typical steam engine indicator diagram,** used to monitor engine performance, by indicating pressure at various positions of the piston.

**m—Flyball governor** consists of balls pivotally mounted, whose speed variations control the valve mechanism to regulate engine speed.

**n—Tandem compound engine** is one in which the cylinders are placed one behind the other. The pistons are both on the same piston rod. The events in the cycle are identical in both units.

**p—Cross-compound engine,** is one in which the engine cylinders are set side by side. Each piston has its own crank and connecting rod, the cranks being 90° apart. A receiver is required for storage of steam, between low and high pressure cylinders, until valve on low pressure side is ready to admit steam.

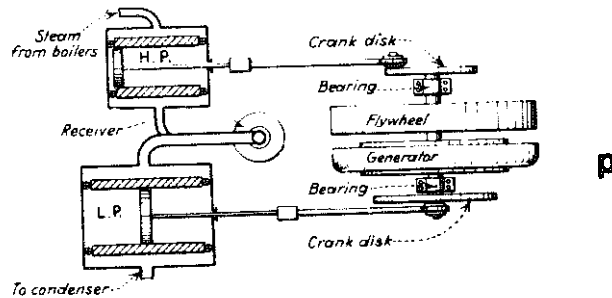
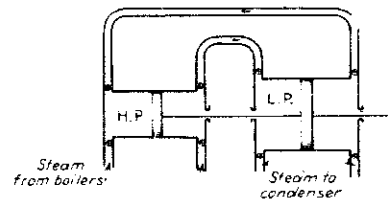
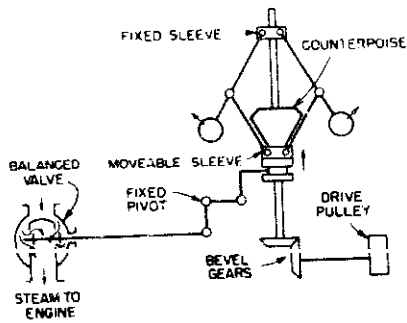
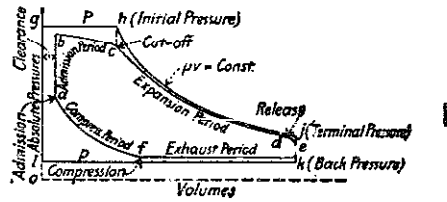
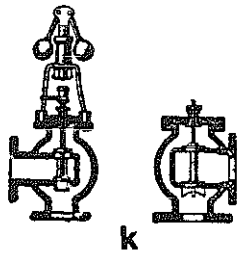
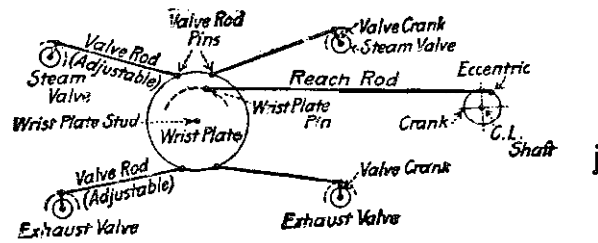
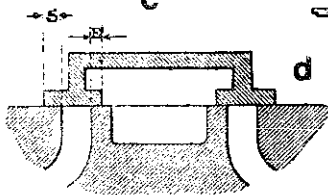
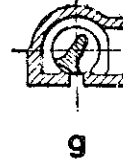
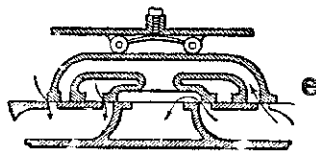
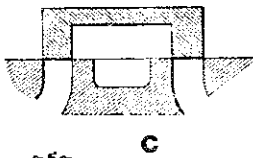
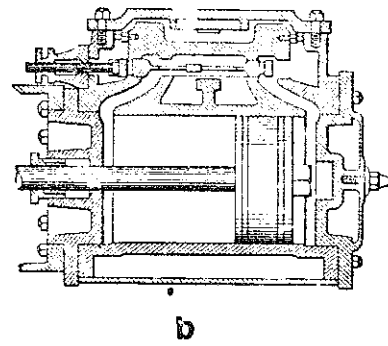
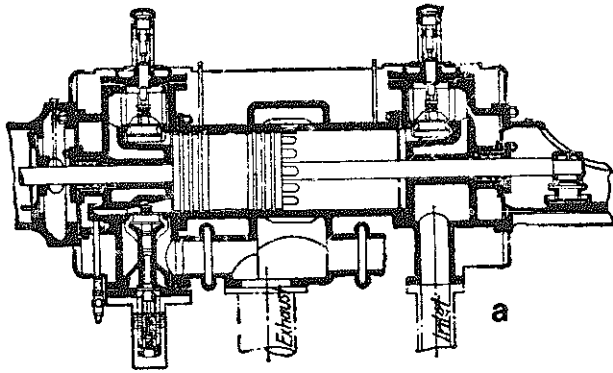

## VI POWER GENERATION

### A-Engines

#### 2-DIESEL-ENGINE PRINCIPLES

**a-Four-cycle suction stroke;** the air is drawn into the cylinder through an open inlet valve by the retreating piston; *a* inlet valve; *b* fuel nozzle; *c* exhaust valve.

**b-Four-cycle compression stroke;** after the piston has passed the dead center, the air-inlet valve closes, the piston starts to return, and compression begins; shortly before the end of this stroke, the fuel valve opens and injection commences; meanwhile, the compression of the trapped air has raised its temperature as high as 1000 to 1200°F, so that ignition of the fuel takes place as soon as it is injected either by mechanical or air injection.

**c-Four-cycle power stroke;** combustion continues during the early part of the succeeding stroke until after the closing of the fuel valve; the temperature reaches about 3000°F (1649°C); after the fuel valve closes and combustion ceases, the gases expand during the remainder of the stroke; the exhaust valve opens somewhat before dead center.

**d-Four-cycle exhaust stroke;** burned expanded gases are expelled during the fourth piston stroke; just before dead center has been reached, the air-inlet valve opens, and the cycle is repeated.

**e-Two-cycle compression stroke;** at the beginning of this stroke, the exhaust ports are still uncovered; at the same time, scavenging air is entering the cylinder; the scavenging air ports are closed by the advancing piston; the exhaust ports are likewise closed an instant later; compression follows during the remainder of the stroke; just before dead center, the fuel valve opens and injection begins.

**f-Two-cycle power stroke;** combustion stops considerably later than when the piston has passed dead center, and the burned gases expand during the remainder of the power stroke; when the exhaust ports are again uncovered by the retreating piston, the gases are released to the atmosphere; an instant later, the cylinder is purged either by the uncovering of the scavenging air ports or by the opening of scavenging air valves; the cycle is then repeated during the next crank revolution; *a* scavenging-air port; *b* fuel nozzle; *c* exhaust port.

**g-Engine scavenging with opposed piston.**

**h-Scavenging through exhaust valves in head.**

**j-Junker's four-cylinder cycle events.**

**k-Mechanical-injection fuel system.**

**l-au-injection fuel system.**

**m-Rotary-type scavenging air blower with end plate removed.**

# DIESEL ENGINE PRINCIPLES

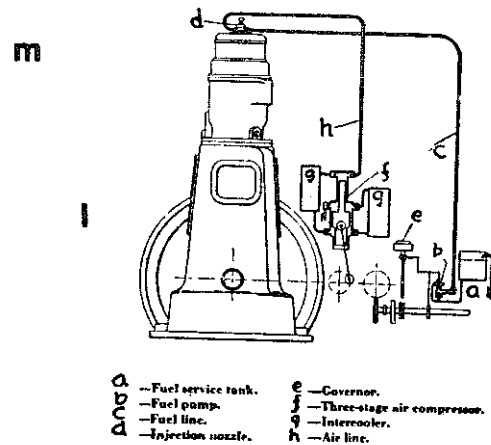
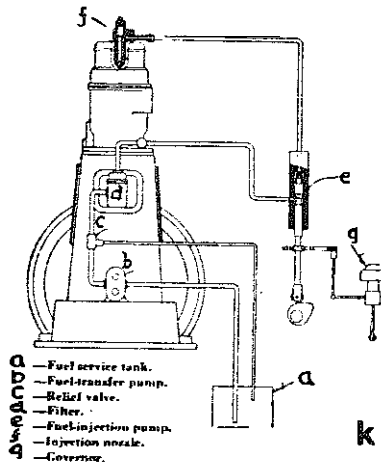
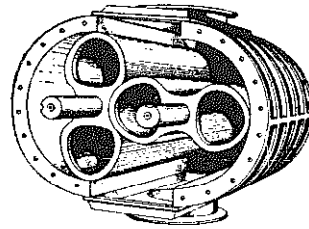
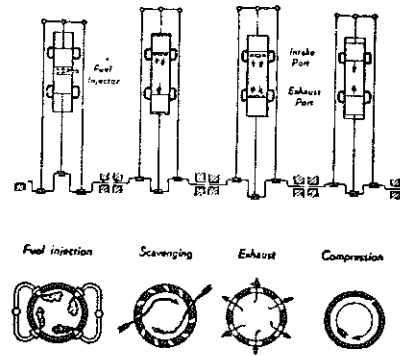
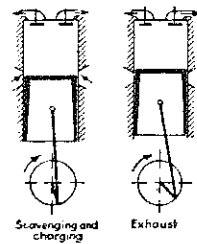
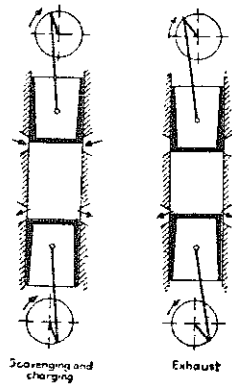
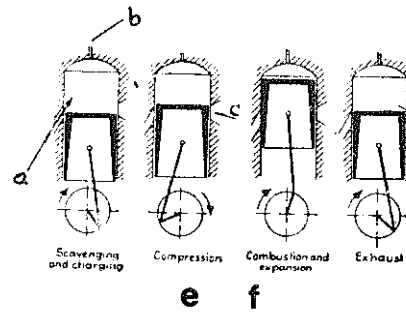
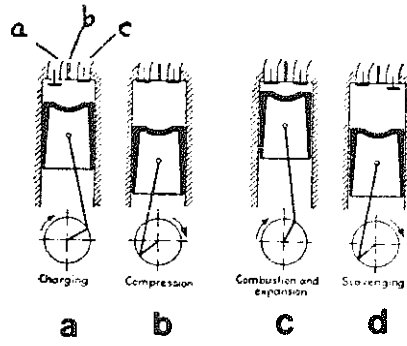

**A-Engines**

**3-INTERNAL COMBUSTION ENGINES**

**a-High tension ignition system.** Breaking of the primary circuit by the opening of the breaker points causes the magnetic field to collapse. The induced current charges the condenser, causing the sudden collapse of the field, creating a high voltage in the secondary. This voltage is distributed to each spark plug in a particular order.

**b-Valve assembly.** Controls the admission to, the trapping in and the exhausting of the working medium from the cylinder.

**c-Breaker mechanism** for 8 cylinder engine, illustrating the details of assembly.

**d--Carburetor.** Elementary illustration showing the formation of an air-fuel mixture consisting of atomizing the fuel and mixing the particles of fuel with air.

**e-Combustion chamber.** Design is critical for maximum performance. Shown is a "valve in head" arrangement. Note: the location of the spark plug is designed to promote rapid burning of the first part of the charge.

**f-V-8 Ford engine.**

# INTERNAL COMBUSTION ENGINES

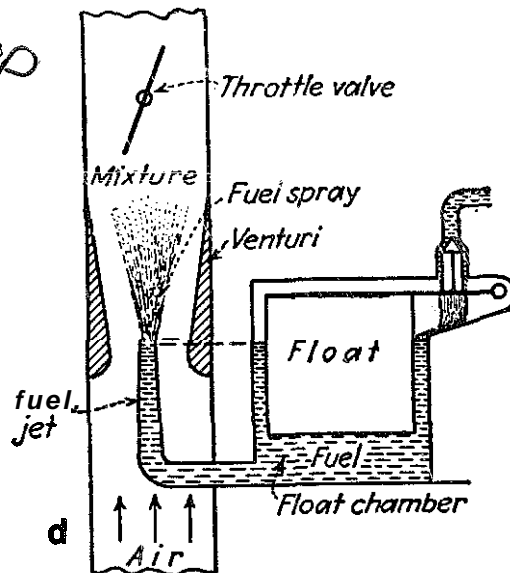
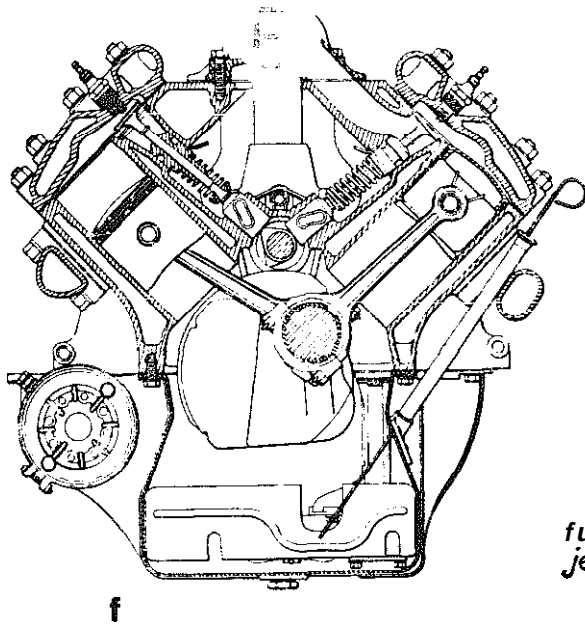
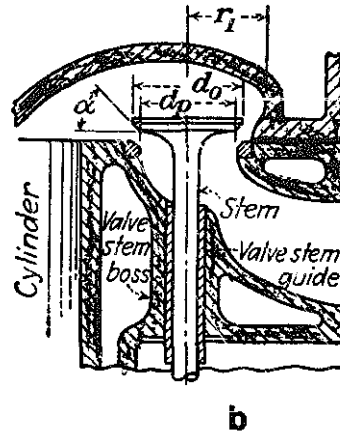
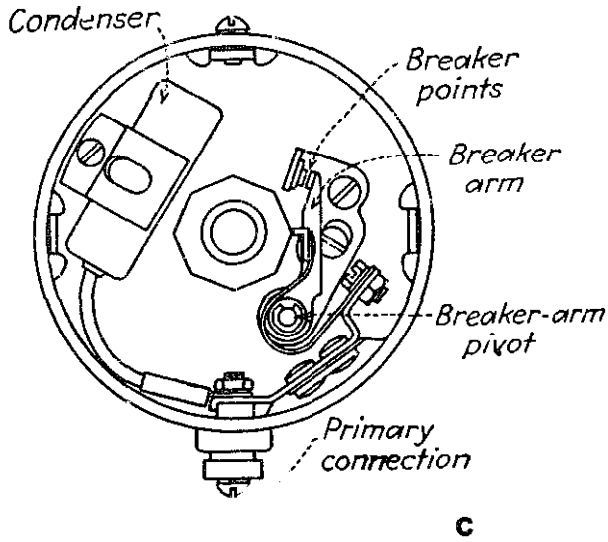
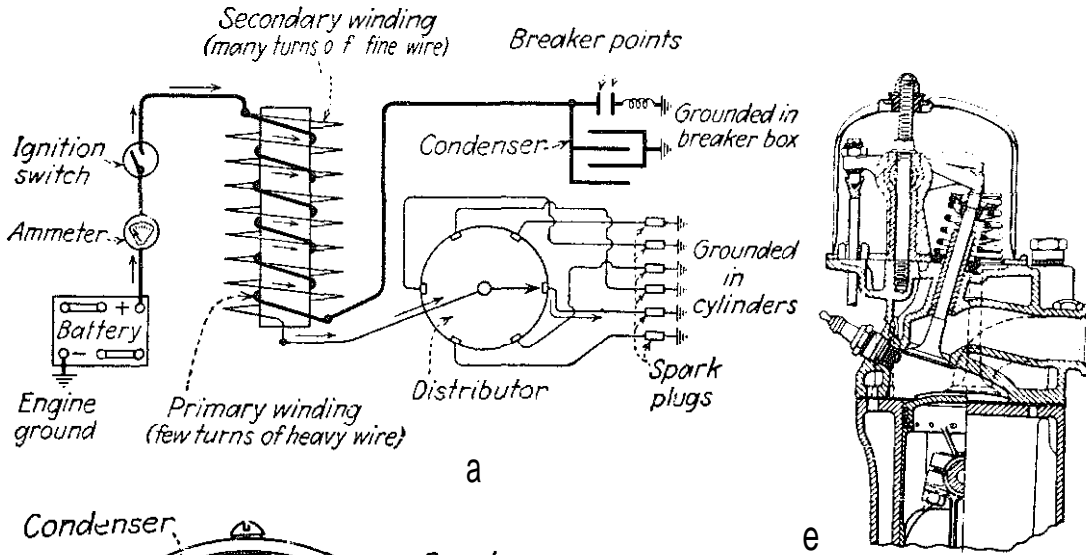

## B—Turbines

### 1-STEAM TURBINES

**a-The high-pressure element of a cross-compound main-propulsion impulse turbine;** a sight-flow indicator and a thermometer are provided in the oil return from each main bearing, which are of the self-aligning, babbitted type; the turbine shaft, at the steam-inlet end, is sealed by combination labyrinth and carbon-ring packing, while at the exhaust end, carbon-ring packing seals are provided.

**b-Low-pressure element of a cross-compound main-propulsion impulse turbine and impulse-astern turbine;** the astern turbine has two impulse stages, the first of which is velocity compounded; sight-flow indicators and thermometers are provided in the oil discharge from each bearing.

# STEAM TURBINES

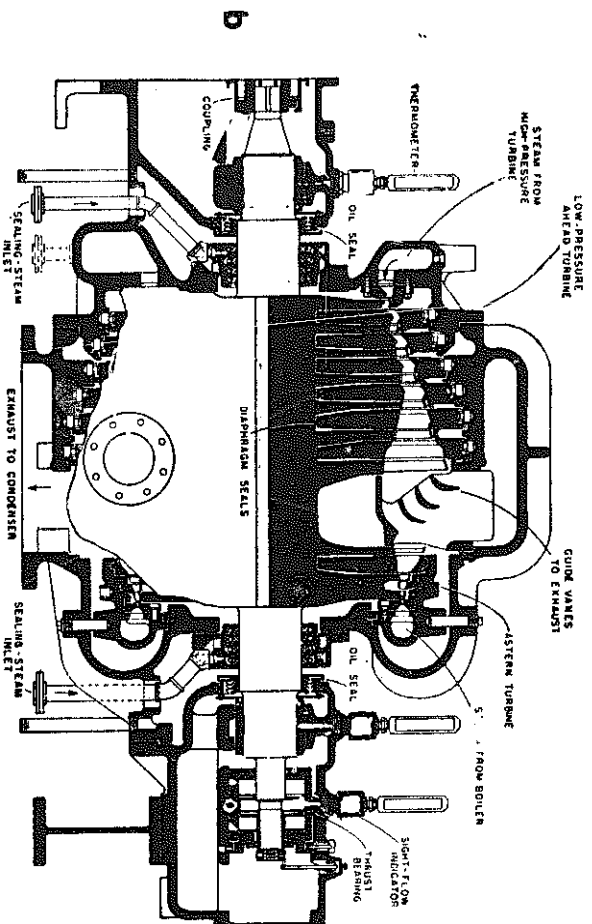
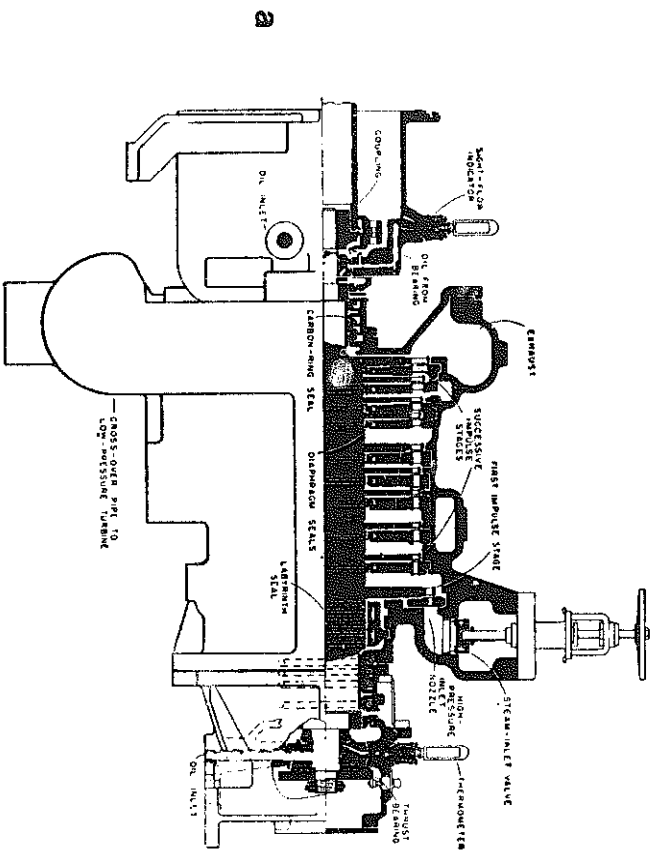



B-Turbines

2-HYDRAULIC-TURBINE PRINCIPLES

**a-Jonval turbine;** *a* chute, guide vane or fixed directrix; *c* bucket or runner.

**b-Jonval turbine;** downward flow; either the upper or the lower set of vanes may be fixed.

**c-Lancaster turbine;** downward discharge; the upper parts of the blades are vertical and receive water tangentially from the gate plates.

**d-Model turbine;** the runner has downward discharge; register gates are pivoted and operated by arms from a sector.

**e-Swain turbine;** inward and downward flow, with inward-curved vanes or flumes.

**f-Camden turbine;** two independent sets of buckets; the upper set is inward and central discharge; the lower set is curved backward, with tangential discharge.

**g-Turbine and gate;** downward flow from angular fixed guide vanes in the water chamber.

**h-Munson double turbine;** the water discharges both upward and downward through curved guide vanes to reverse curves in top and bottom runner wheel vanes.

**j-Warren central-discharge turbine;** the wheel revolves inside the fixed directrix; water enters from outside and discharges into and beneath the wheel.

**h-Foumeyron turbine;** the rim of the outer buckets is revolving around the inner fixed directrix, the water flowing outward.

**l-Leffel double-runner turbine;** the upper section of the runner discharges inward and down the center; the lower section has curved blades to discharge downward; there is one register gate for both sections.

**m-Properly formed guide vanes** for impulse wheels.

**n-Improperly formed guide vanes** for impulse wheels.

**o-Apparatus for measuring** the force of a water jet; the total force measured by the weight  $w$ ;  $v$  is the direction of force.

**p-Right-angle jet;** the vertical force is measured by a platform scale, the horizontal force, by a spring scale.

**q-Governor.**

# HYDRAULIC TURBINE PRINCIPLES

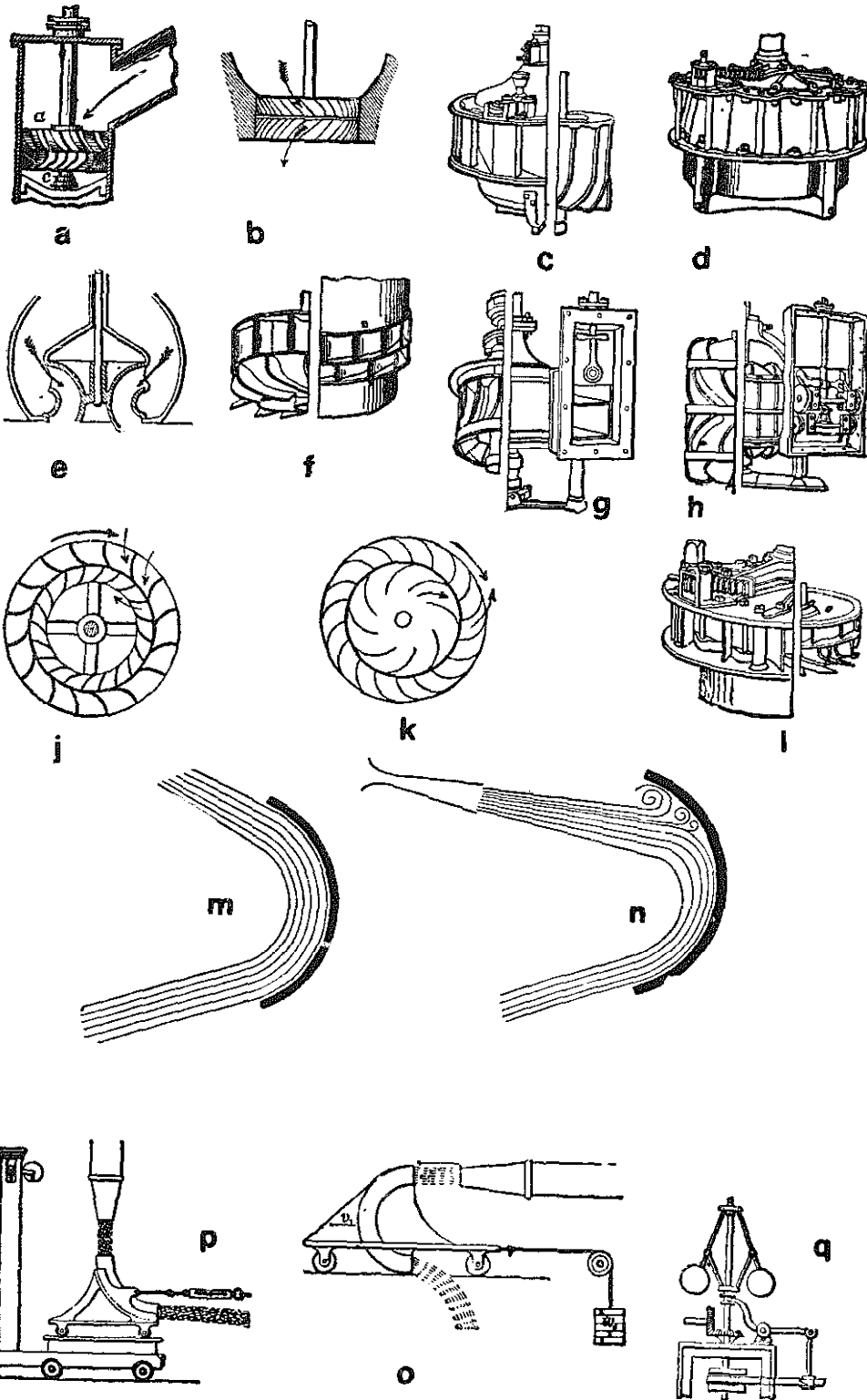

**B-Turbines**

**3 -HYDRAULIC WHEEL DESIGN**

**a,b-Gravity machines;** they are rarely used but illustrate the principle.

**c-Overshot wheel;** a gravity machine with steel buckets.

**d-“Lefte” overshot wheel.**

**e-Overshot wheel.**

**f-A more efficient overshot design.**

**g-Oscillating-cylinder pressure engine.**

**h-Pressure-type hydraulic riveter.**

**j-Hydraulic cylinder with Thorp controller for hydraulic lifts.**

**k-Pelton wheel;** typical velocity machine.

**I-Doubie bucket** for improving efficiency of a Pelton wheel due to a cut-out lip.

**m-Buckets of a Peiton wheel,** showing the method of separating jet and returning the parts nearly in line with the impact jet, thus gaining about 85 per cent of power.

**n-Breast water wheel;** the power is about 30 per cent of the fall.

**o-Undershot water wheel** with a power about 30 per cent of water fall; used with heads less than 6 feet.

**p-Saw-mill water wheel.**

**q-Flutter water wheel;** it has very low efficiency.

**r-Current wheel;** it has low efficiency.

**s-Barker wheel** for small power; low-efficiency reaction type.

**t-Breast wheel.**

**u-Water-wheel governor.**

**v-Pelton-wheel buckets.**

HYDRAULIC WHEEL DESIGN

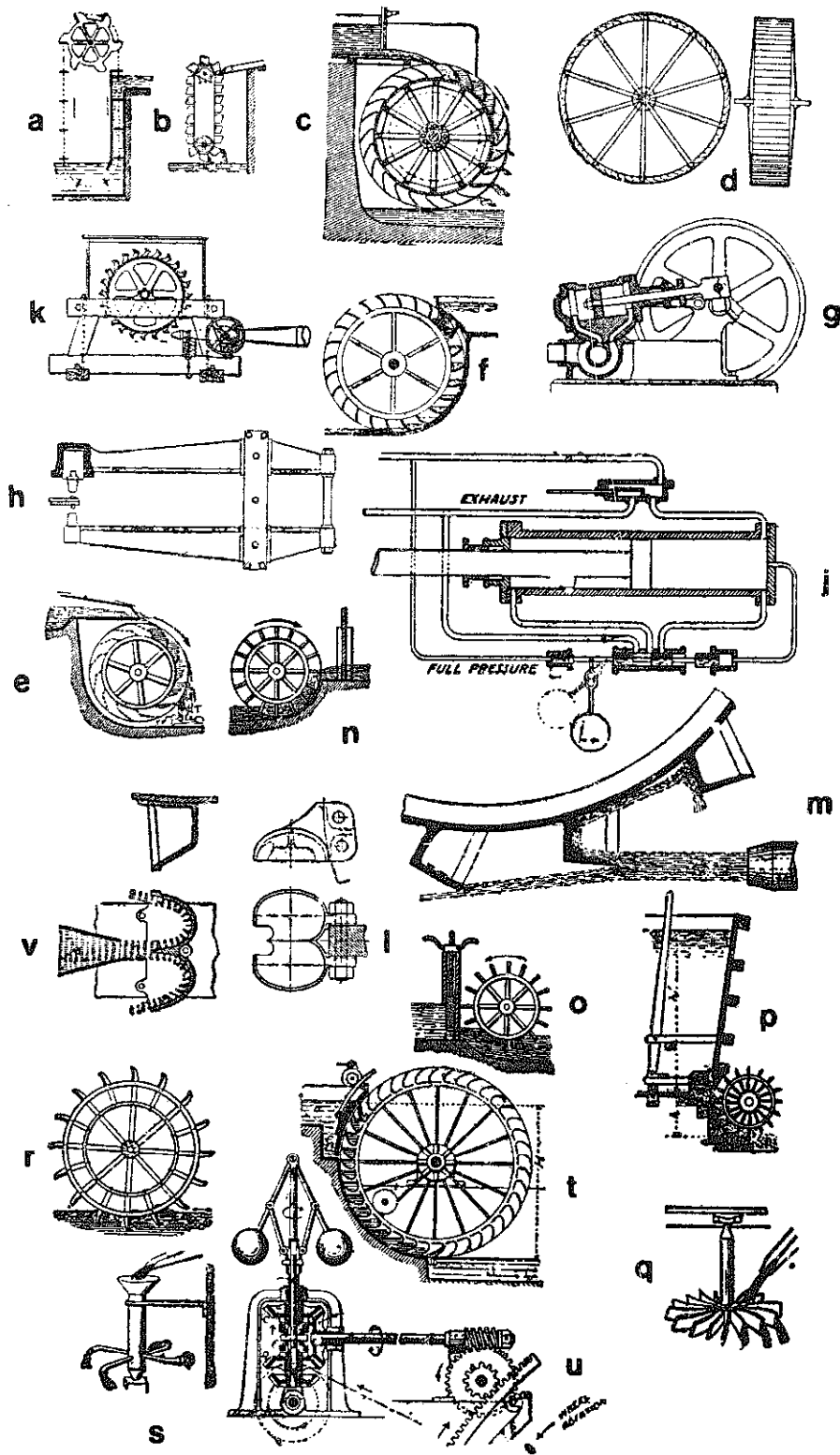

**B--Turbines**

**4--GAS TURBINES**

**a--Heron's gas turbine** from 130 B.C.

**b--The "smoke jack"** from the 17th century.

**c--The steam engine.**

**d--Steam turbine.**

**e--Aviation-gasoline or diesel engine.**

**f--Gas turbine.**

**g,h--Relation between a typical domestic oil burner and the elementary gas turbine;** both the blower and generator are driven by the gas turbine.

**j--Single turbine unit** without heat exchanger; rows of blades deliver a considerable amount of useful power to the propeller; rows of stationary blades alternate with rows of rotating blades; each stationary blade redirects the hot gases or air against the passing rotating blades; this arrangement is known as the simple cycle.

**k--Single turbine unit** with heat exchanger; known as the regenerative cycle.

**l--Engine with exhaust-gas-driven turbo-charger;** the arrows show the movement of the air into the combustion space, forcing the exhaust gases out and into the turbine.

# GAS TURBINES

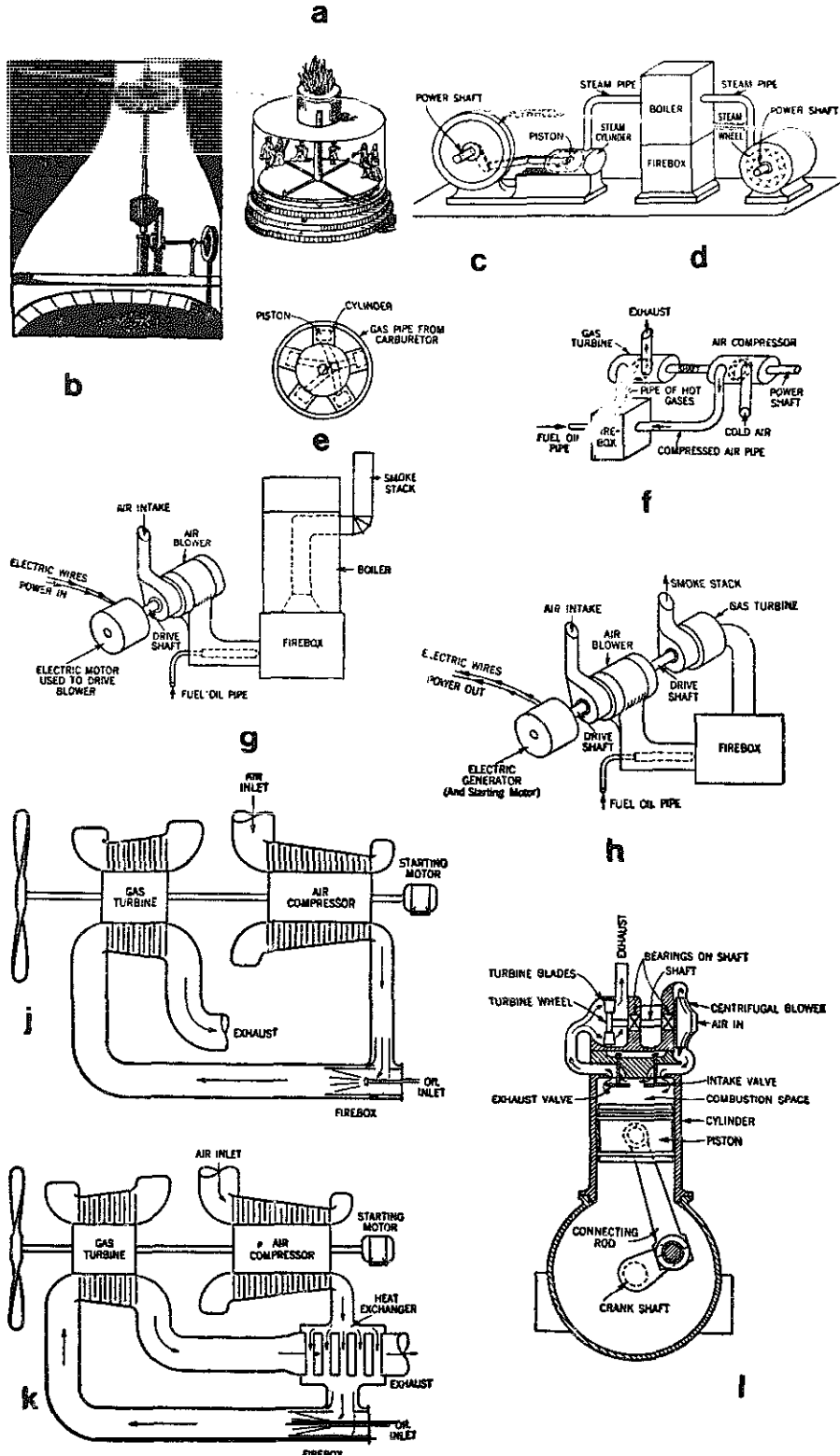

## C—Rockets and Jets

### 1-JET PROPULSION

**a—Campini design** of high-altitude craft for operation at either subsonic or supersonic speeds. The control cabin is pressure charged; *A* ovoid cabin; *B* enshrouding cylinder; *C* two-stage centrifugal compressor; *D* radial engine; *E* rectifier-radiator; *F* combustion space; *G* annular mixing channel; *H* discharge nozzle; *J* cone for varying the nozzle orifice; *K* controlled lateral orifices; *L* slidable shroud ring.

**b—Gas turbine-jet design** in Air Commodore Frank Whittle's first jet-propulsion patent; *1* air in; *2* rotating portion of the compressor; *3* combustion chamber, showing the oil spray; *4* turbine wheel; *5* exhaust jet.

**c—Jet-propulsion design** made by A. Lysholm and sponsored by Milo Aktiebolaget, of Stockholm, Sweden; the streamlined Milo unit is intended for wing installation; all the air compressed by the multistage blower is passed to the combustion chamber and, with added fuel, is expanded through the multistage gas turbine; *A* four-stage centrifugal compressor; *B* air chamber; *C* combustion chamber; *D* turbine; *E* fuel injector; *F* discharge nozzle.

**d—Sweden's Ljungstrom's gas turbine** unit embodying dual twin-rotor blowers for compressing the air; special arrangements are made for speeding-up the compressor to permit rapid acceleration of the aircraft at the take-off or in emergency; *A* screw-type, twin-rotor compressors; *B* air chamber; *C* combustion chamber; *D* turbine; *E* discharge conduit; *F* upper auxiliary conduit; *G* lower auxiliary conduit.

**e—Self-contained all-rotary jet-propulsion unit** patented by Max Hahn and assigned to the firm of Ernst Heinkel, Germany; *A* blower impeller; *B* turbine wheel; *C* air-flow guide ring; *D* annular combustion chamber; *E* combustion-air passage; *F* fuel injector; *G* insulation passage.

**f—Ljungstrom's gas-turbine screw and jet-propulsion unit** with multistage centrifugal compressor; *A* centrifugal compressor; *B* air inlets; *C* annular air duct; *D* combustion chamber; *E* bulkhead; *F* fuel nozzles; *G* gas turbine; *H* discharge duct; *J* discharge flap; *K* effluent by-pass flap.

JET PROPULSION

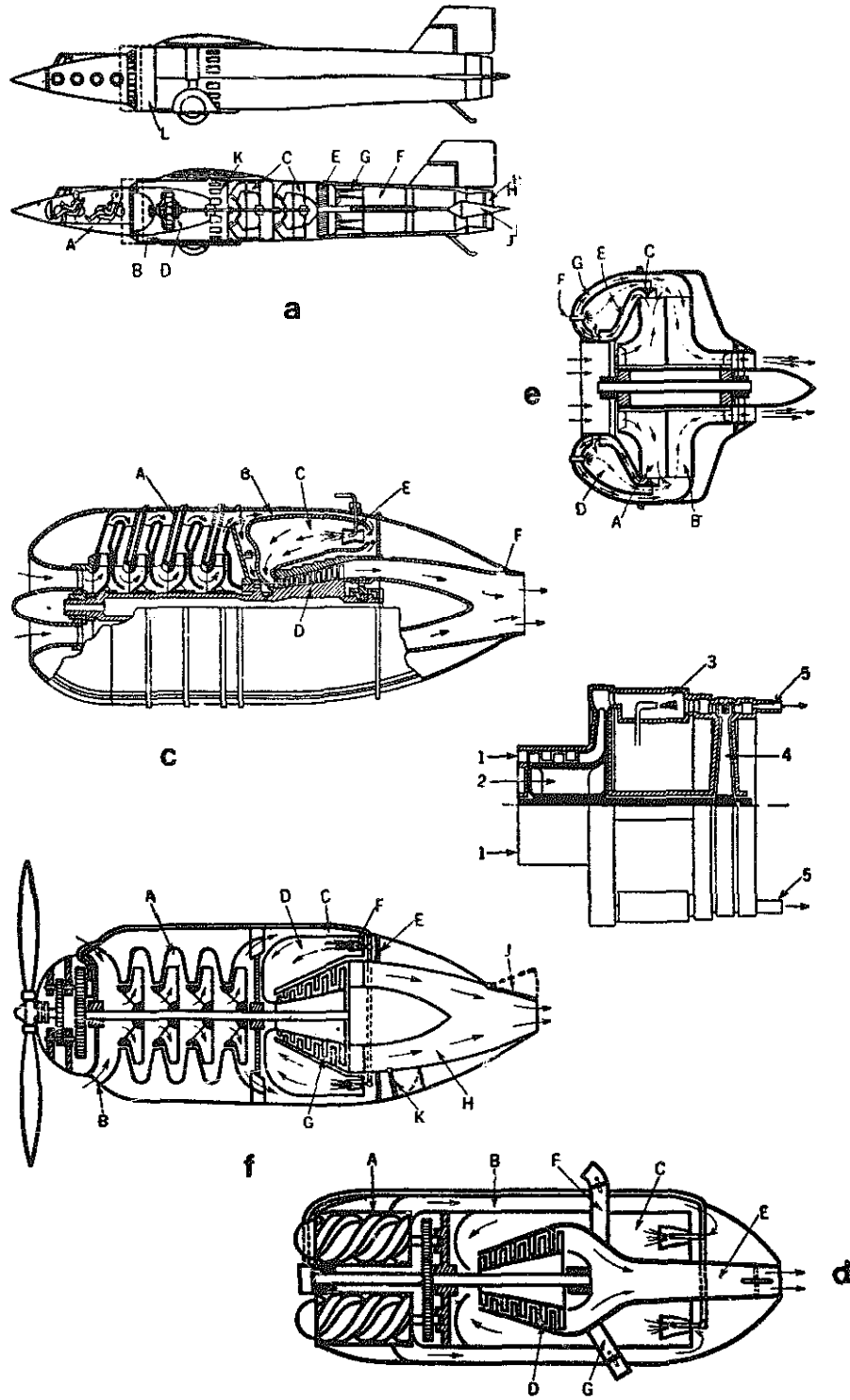



C—Rockets and Jets

2—ROCKETS AND JETS

**a-Dry-fuel reaction-rocket** motor; true rocket type.

**b-Liquid-fuel reaction-rocket** motor; true rocket type.

**c-Thermal-jet engine** (Turbojet); air-stream engine type.

**d-Intermittent duct engine** (buzz-bomb engine); air-stream engine type.

**e-Continuous duct engine** (athodyd); air-stream engine type.

**f-Simple sky rocket.**

**g,h—Sounding r o c k e t** with gyro control having regenerative motor and collapsible fuel bag; for vertical flight carrying instruments; a prewar design, now obsolete

**j-Rocket trajectory** of “g, h.”

**k-Jet-propulsion** action of solid-propellant rocket motor.

**I-Jet-propulsion** action of liquid rocket system.

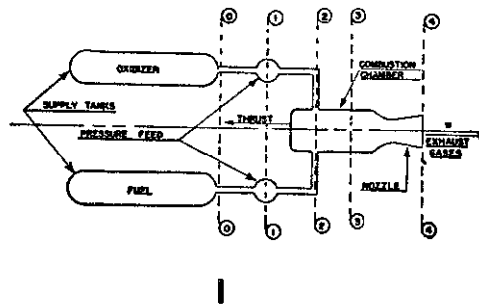
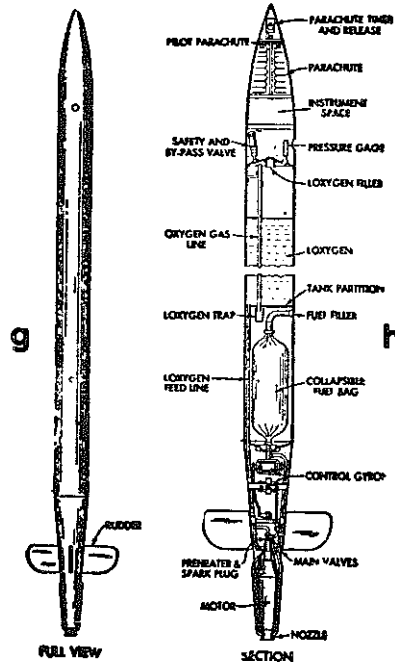
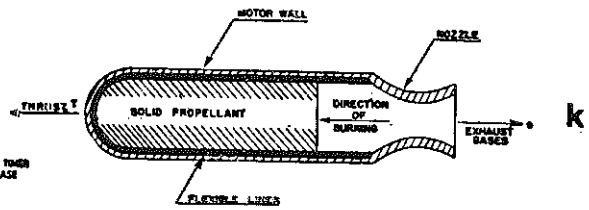
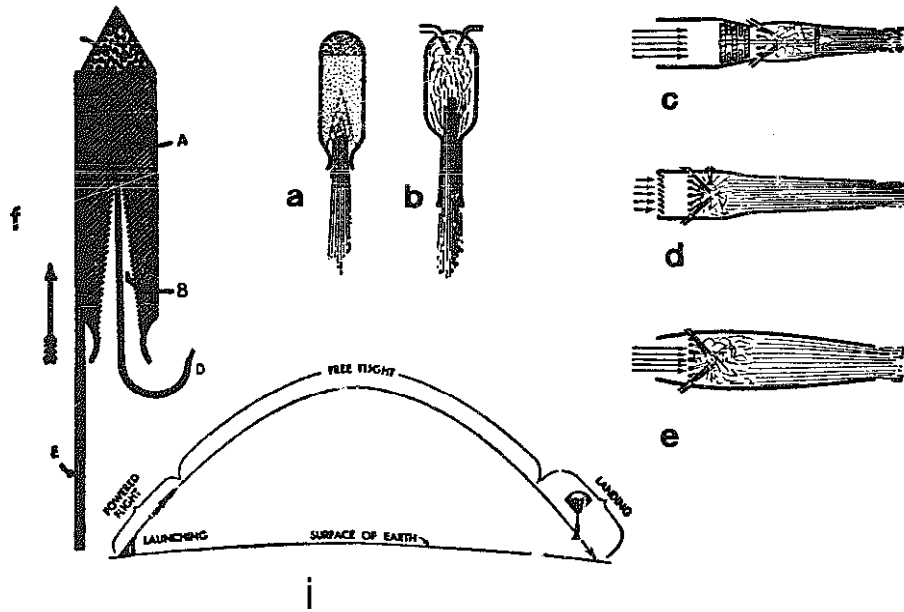

**D-Electric Power**

**1 -ELECTRICAL GENERATORS**

**a-Simple coil** of wire carrying an electric current which produces a magnetic field; the field is stronger if a steel bar is placed within the coil to form a core.

**b--Horseshoe core.**

**c-current generation** in an electric conductor by moving it through a magnetic field; the direction of the voltage depends on the direction of the field and on the direction of the motion of the conductor; the strength of the current depends on the speed of the conductor and the strength of the magnetic field.

**d-Simple electric generator** with single-phase, revolving armature

**e-Loop of wire rotating** in a magnetic field; the generated voltage depends on the speed of cutting across the field, on the field strength, and on the length of the wire.

**f-Single-phase voltage curve**, representing variations in voltage during two revolutions in a magnetic field.

**g-Two simple generators** rotating on the same shaft; the single-loop armatures are always at right angles to each other and in fields of the same strength.

**h--Two-phase voltage curve.**

**j-Two-phase alternator** formed by two single-phase alternators combined into one machine with both armature windings rotating in one magnetic field.

**k-Three separate loops** of wire revolving in the same magnetic field with each loop brought out to a separate pair of slip rings and a separate external circuit.

**I-Voltage variation** of a three-phase alternator; at every point, the value of one voltage is equal and opposed to the sum of the other two, values below zero being negative.

# ELECTRICAL GENERATORS

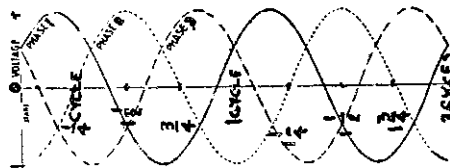
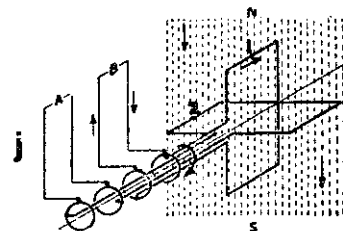
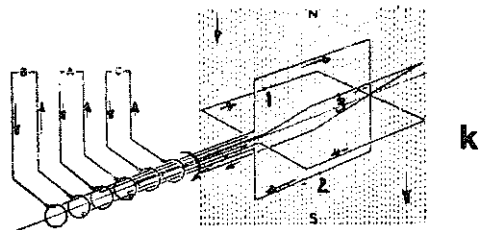
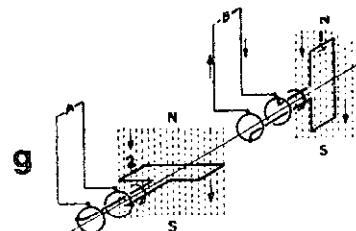
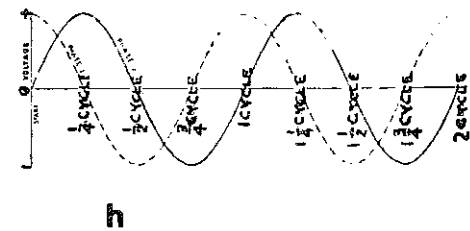
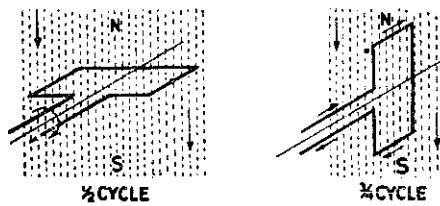
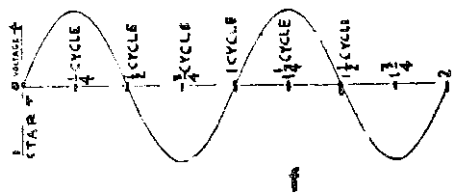
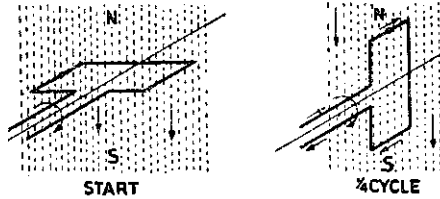
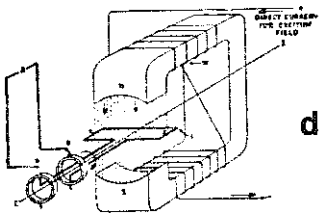
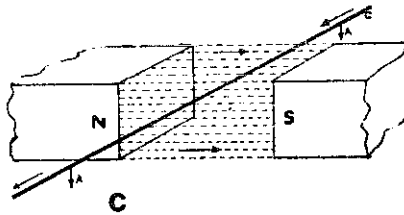
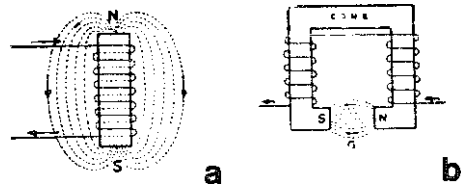

D—Electric Power

I-ELECTRIC GENERATORS (Cont)

**m-Three loops connected** together within the alternator; only three slip rings are required, because each ring can serve two outside circuits.

**n-Transformer** used for changing the voltage of alternating currents; the windings are insulated from each other.

**p—Auto transformer** having only one winding which is divided into two parts; it changes the voltage, but does not insulate the two circuits.

**q—Relation between alternating and direct currents;** a direct current has a steady value; an alternating current continually changes; the two currents shown have the same effective value.

**r—Simple direct-current generator** with two poles separately excited; a commutator is used to keep the current in the inside circuit flowing continually in the same direction.

**s—Simple single-phase alternator** with a revolving armature and four poles; the number of poles does not determine the number of phases.

**t—Single-phase alternator** with six poles in a revolving field.

**u—Current, voltage, and power** in a circuit operating at unity power factor; the current rises and falls with the voltage, and the power is always positive; at every point the product of current and voltage gives the power.

**v—Current, voltage, and power** in a circuit containing inductance; the current always lags behind the voltage so that the product of current and voltage is not always positive; the power is always zero when the current or voltage is zero.

**w—Slip rings.**

**x—Split-ring commutator.**

# ELECTRICAL GENERATORS

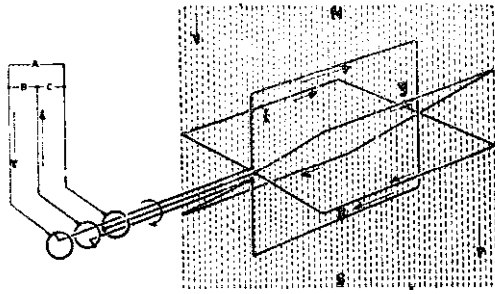

m

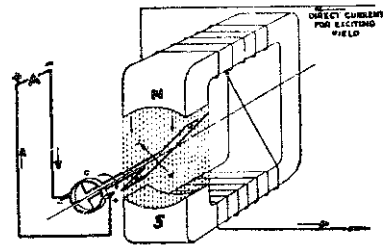

r

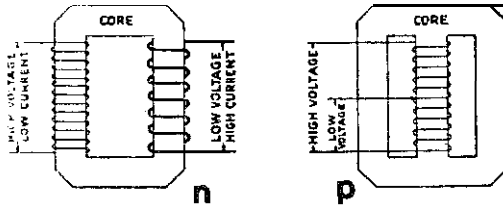

n

p

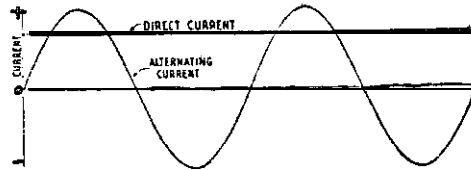
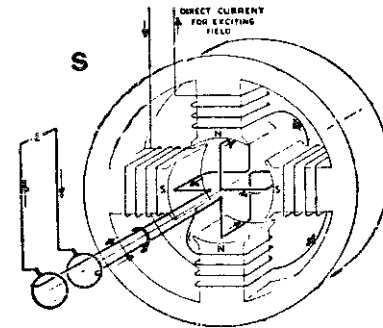

q

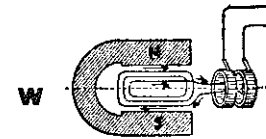

w

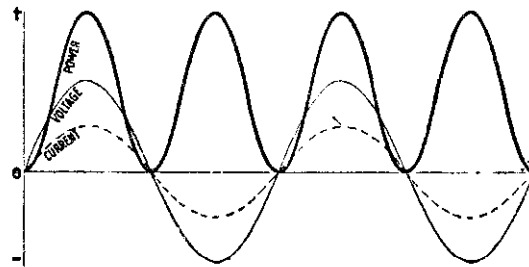

u

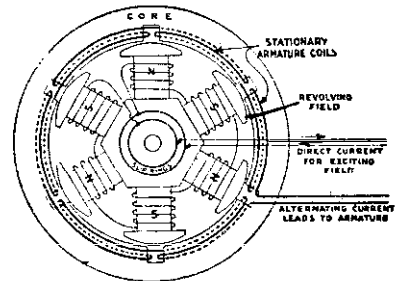

t

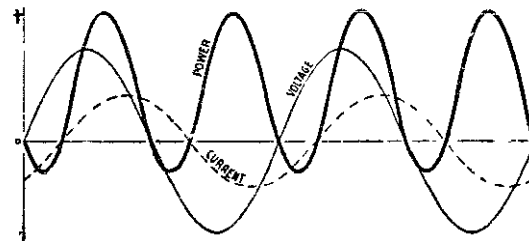

v

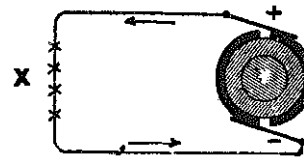

x

## VII STRUCTURAL ENGINEERING

A-Structures

1—FABRICATED SECTIONS

**a—I-beam, standard.** Example of designation: 15 I 42.9. This means a section of 15 inches depth of an I-beam weighing 42.9 pounds per lin. ft. All other properties are obtained from tables.

**b—I-beam of same group as “a”, but heavier.** Only width of flange and thickness of web are increased.

**c—I-beam.** X and Y axes for which tables list properties.

**d-Standard channel.** Example of designation: 15 [ 33.9. This means a section of 15 inches depth of a channel weighing 33.9 pounds per lin. ft.

**e-Wide flange section.** They generally have parallel face flanges. Example of designation: 14 WF 34.

**f-Structural Tee.** These are produced by splitting an I or WF section. Example of designation: ST 10 WF 49.

**g-Tee.** Example of designation: T 4x4x13.5. This is a special section.

**h-Z-section.** Sample designation: Z 4x3-1/16 x 8.2, which means a depth of 4 inches, a flange width of 3-1/16 inches and a weight of 8.2 pounds per lin. ft.

**j-Bulb angle.**

**k-Angle, unequal legs.** Sample designation: <5x3x $\frac{1}{2}$ .

**l-Angle, equal legs.** Sample designation: <4x4x $\frac{1}{2}$ .

**m-H-section.**

**n-Bulb-T section.**

**p-Flat bar.**

**q—Standard rolled shapes.** Available for welded design.



FABRICATED SECTIONS

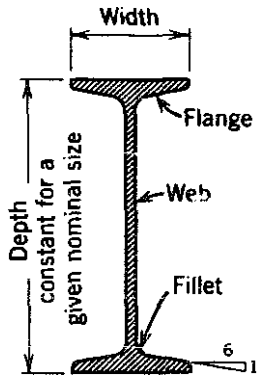

a

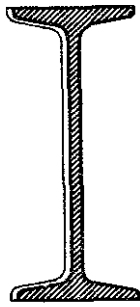

b

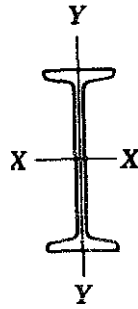

c

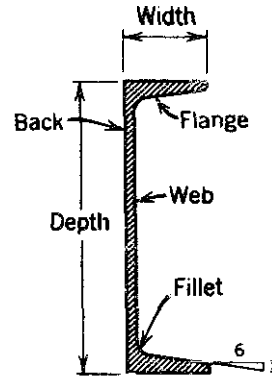

d

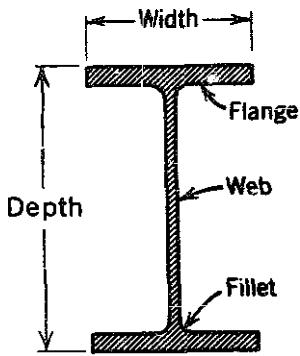

e

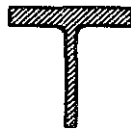

f

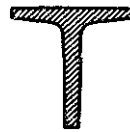

g

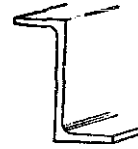

h



j

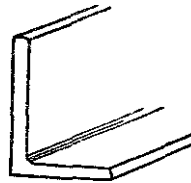

k

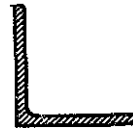

l

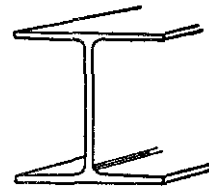

m

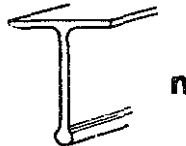

n

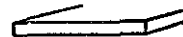

o



4

A-Structures

2-BUILT-UP SECTIONS, GIRDERS AND COLUMNS

a-t-beam and two channels.

b-Two tees and one plate.

c-Two channels and two plates.

d-Two angles welded together.

e-Two channels welded together.

f-Box girder; riveted type; weight 10,617 pounds; supports at center 146,000 pounds.

g-Welded girder of the same design as "f"; weight 8,288 pounds; supports at center 146,000 pounds.

h-Craneway of welded construction; requires great lateral stability; tops of columns are connected by deep horizontal members.

j-Cross-section through a girder like "p."

k-Tubular swelled strut of steel plate; used for masts, sheer legs and crane jibs.

l-Strut formed of tube, with the end collars screwed in.

m-Ordinary solid swelled distance rod with collars; used for compressive strains.

n-Braced strut; usually of flat bars.

p-Construction of a heavy girder.

BUILT-UP SECTIONS

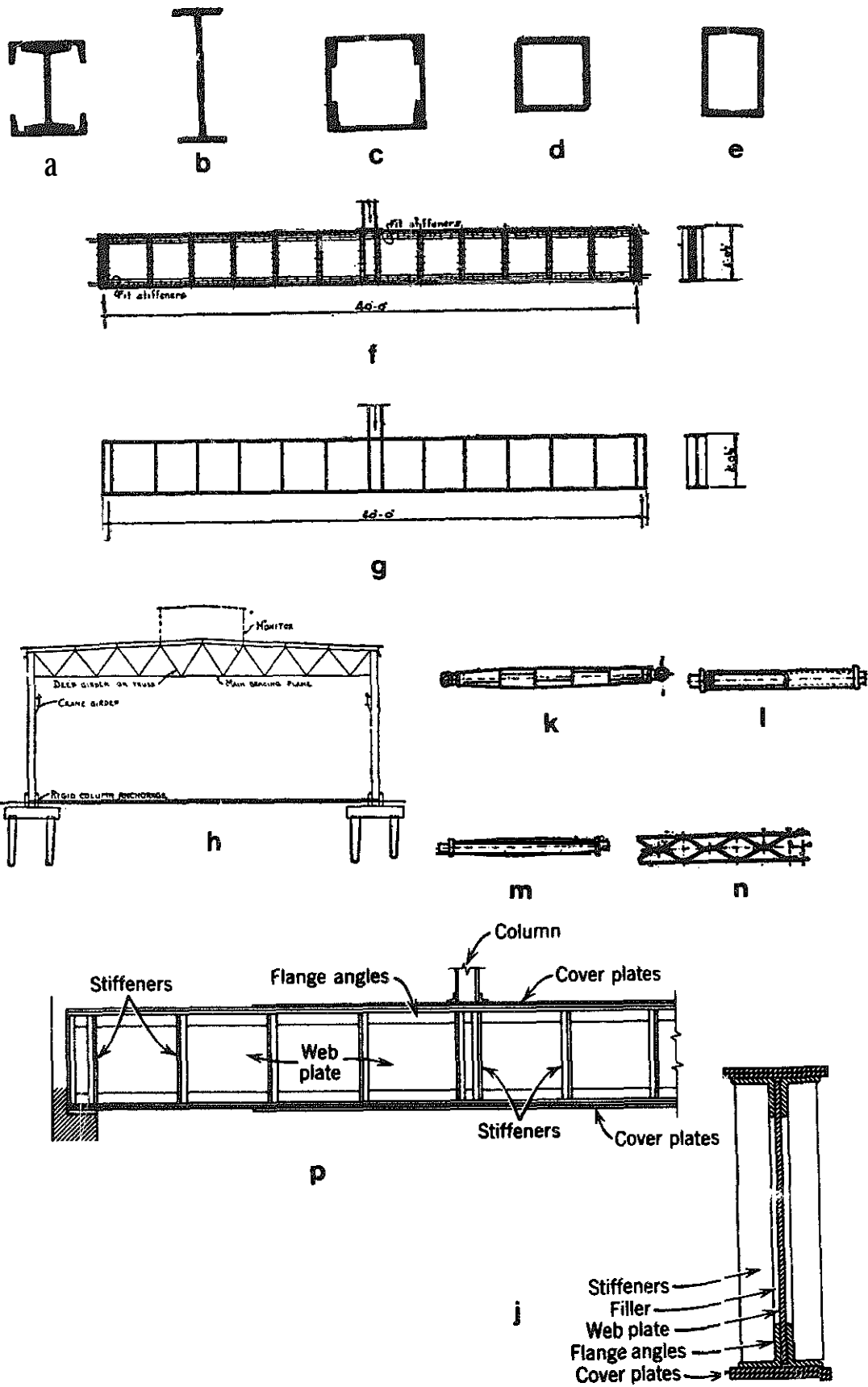

**A—Structures**

**2—BUILT-UP SECTIONS, GIRDERS AND COLUMNS (Cont)**

**q-Separator.** Spaces two beams correctly. Used are two angles and one plate.

**r-Framing detail.** Filler beam dropped, to avoid coping.

**s-Coping.** Used if top of beams have to be at same height.

**t-Framing detail,** using rivets.

**u--Blocking.** Similar to coping.

**v-Framing detail,** beam to column.

**w--Same as "v".**

**x--Same as "v".**

**y-Rolled wide flange sections** are usually used as columns.

**z-Column strength increased through plates** welded to flanges.

**aa--Another built-up column section.**

**ab-Column built-up** from two channels and two plates.

**ac-Splicing** of columns of the same width.

**ad-Column splicing.** Filler plates are used to make up the difference in width.

**ae-Special splice** and filler plates, to make splicing columns of different size of I-beams possible.

BUILT-UP SECTIONS

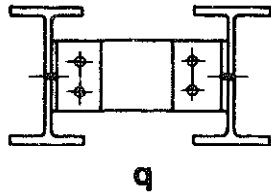

q

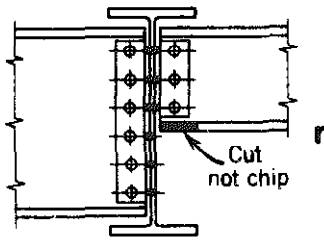

r

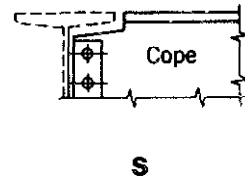

s

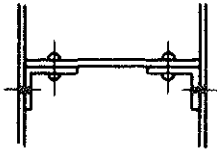

t

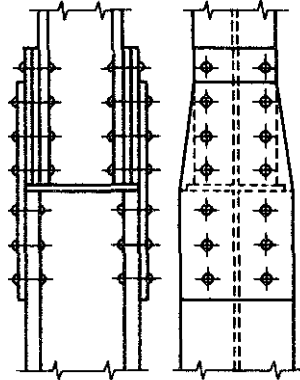

ae

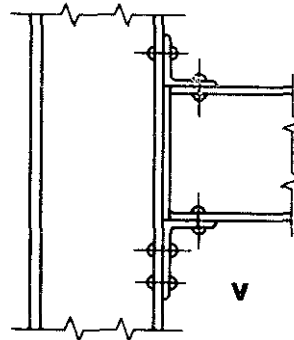

v

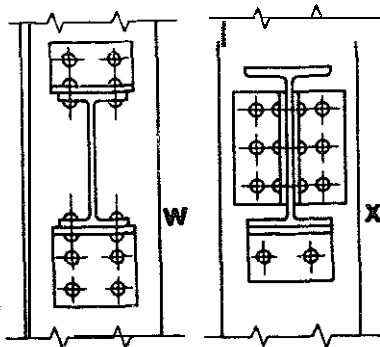

w

x

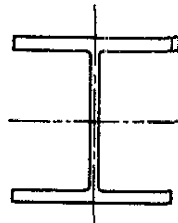

y

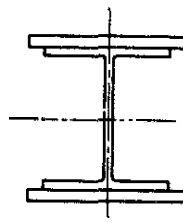

z

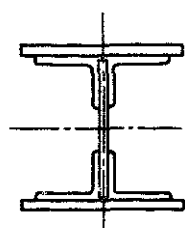

aa

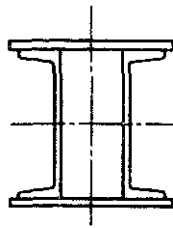

ab

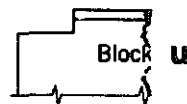

u

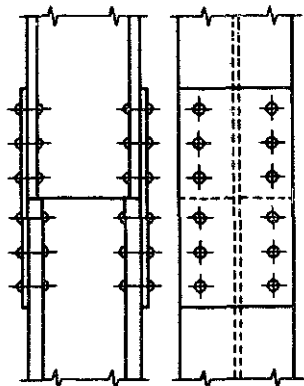

ac

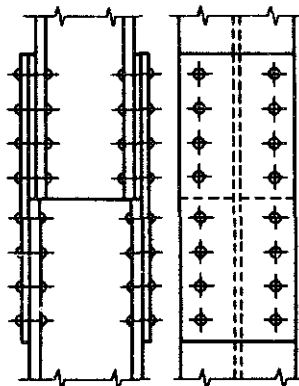

ad

**A—Structures**

**3—STRUCTURAL STEEL FASTENERS**

**a—Node** of riveted truss.

**b - Node** of welded truss, showing how the welded design cuts the dead weight as compared with “a”.

**c, d, e, f—Miscellaneous tie rods.**

**g—Sleeve nuts** for tie rods. (Bethlehem Steel Co.)

**h, j, k—Column base plates.**

**I—Framing** continuous beams to girders.

**m—Arc-weld design** of double-web bar frame.

# STRUCTURAL STEEL FASTENERS

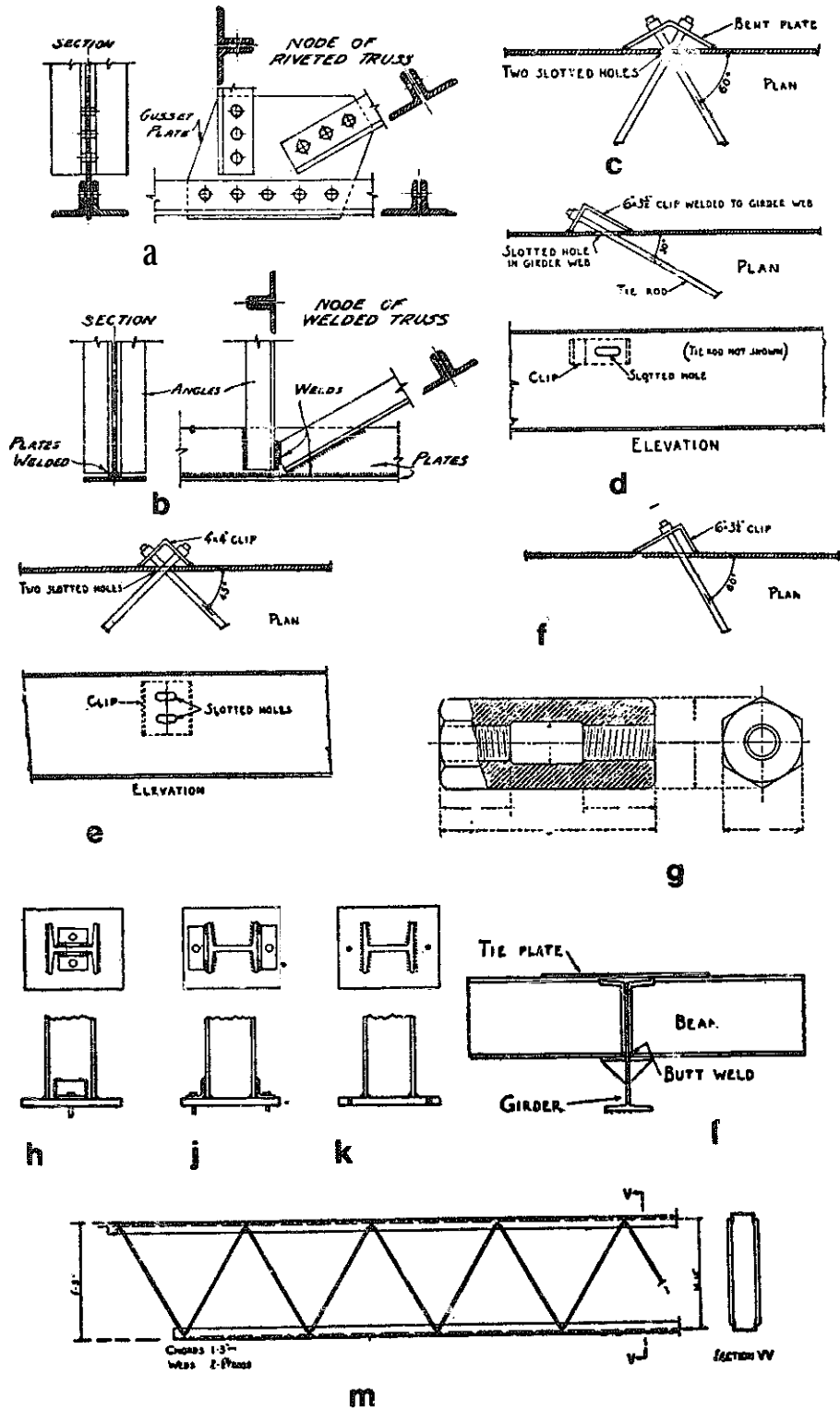

**A—Structures**

**4—I-BEAM SUPPORTS AND TRACKS**

**a—Double I-beam overhead track.**

**b—Single I-beam overhead track.**

**c-Cobum-type track.**

**d-Bar track.**

**e—Monorail hoist.**

**f-Welded-type crane-rail supports.**

**g-I-Beam track supports.**



# I-BEAM SUPPORTS & TRACKS

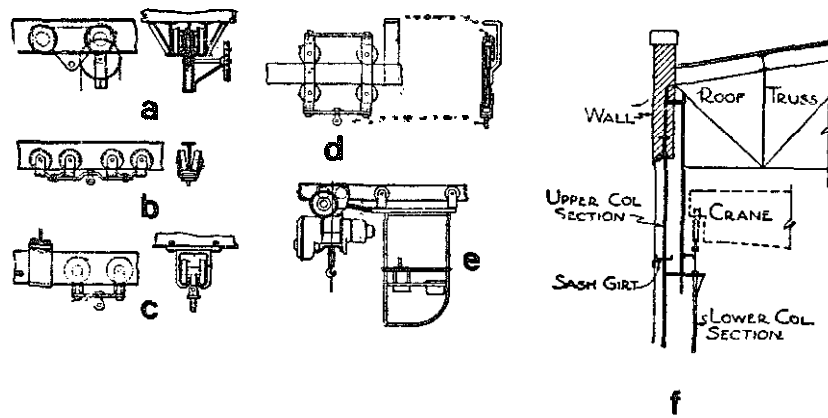

g I - BEAM TRACK SUPPORTS

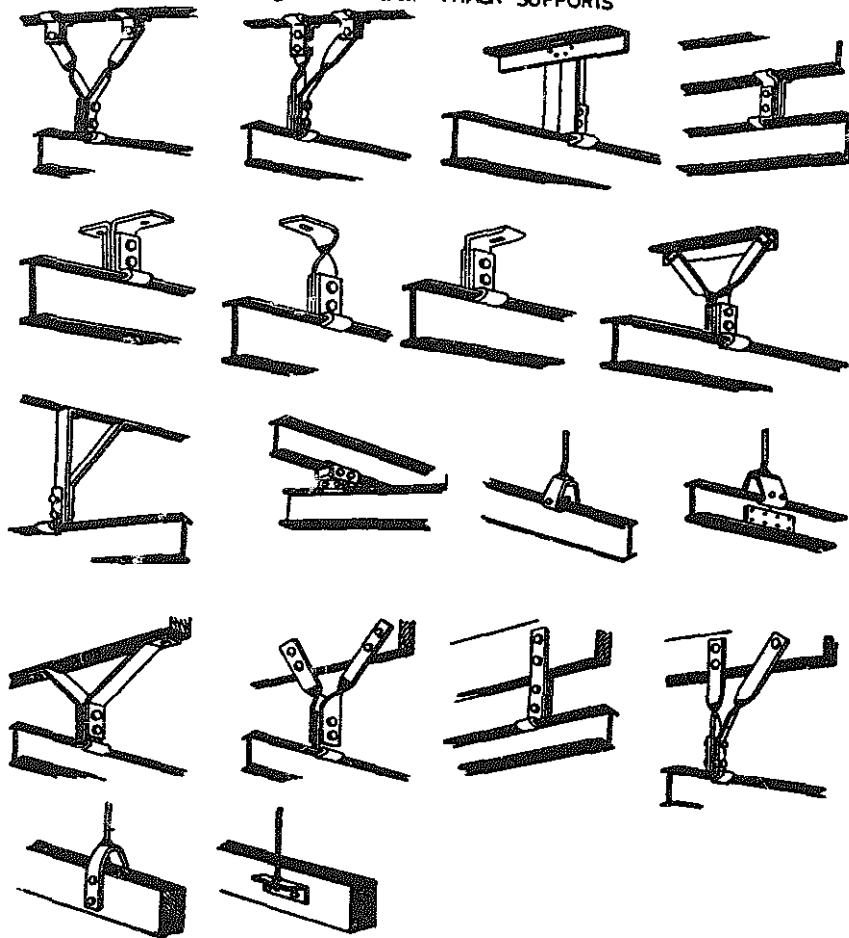

## A-Structures

5—TRUSSES. A truss is an assemblage of members (beams, struts, etc.) arranged in combinations (triangles) to form a rigid framework. Trusses a, b, c, are adaptable for steel or wood.

**a—King post truss.** A roof truss. The members shown in heavy lines are in compression. Design adaptable for steel or wood construction. To avoid repeated calculations, tables are available in handbooks for these structures. The stresses in members are found, by multiplying the coefficients in the table, by the panel load "P". Only one set of coefficients is shown, for h/L of 1/3. Each member of the truss is located through the numbering system shown.

Pitch $\frac{h}{l}$	Coefficients of P for Stress in				
	AD	BD	CE	DE	EF
1/3	2.25	2.71	1.80	0.90	1.00
1/4	3.00	3.35	2.24	1.12	1.00
1/5	3.75	4.03	2.69	1.35	1.00

**b—Simple Fink Truss.** A roof truss. Comments same as under "a". The table, of course, will have different coefficients.

**c—Fan truss.** A roof truss. Comments same as under "a".

**d—Fink truss.** A roof truss. Comments same as under "a".

**e—Steep roof truss,** riveted design.

**f, g, h—Three types of floor trusses.**

**j—Joint for a timber truss.**

**k—Joint for a timber truss.**

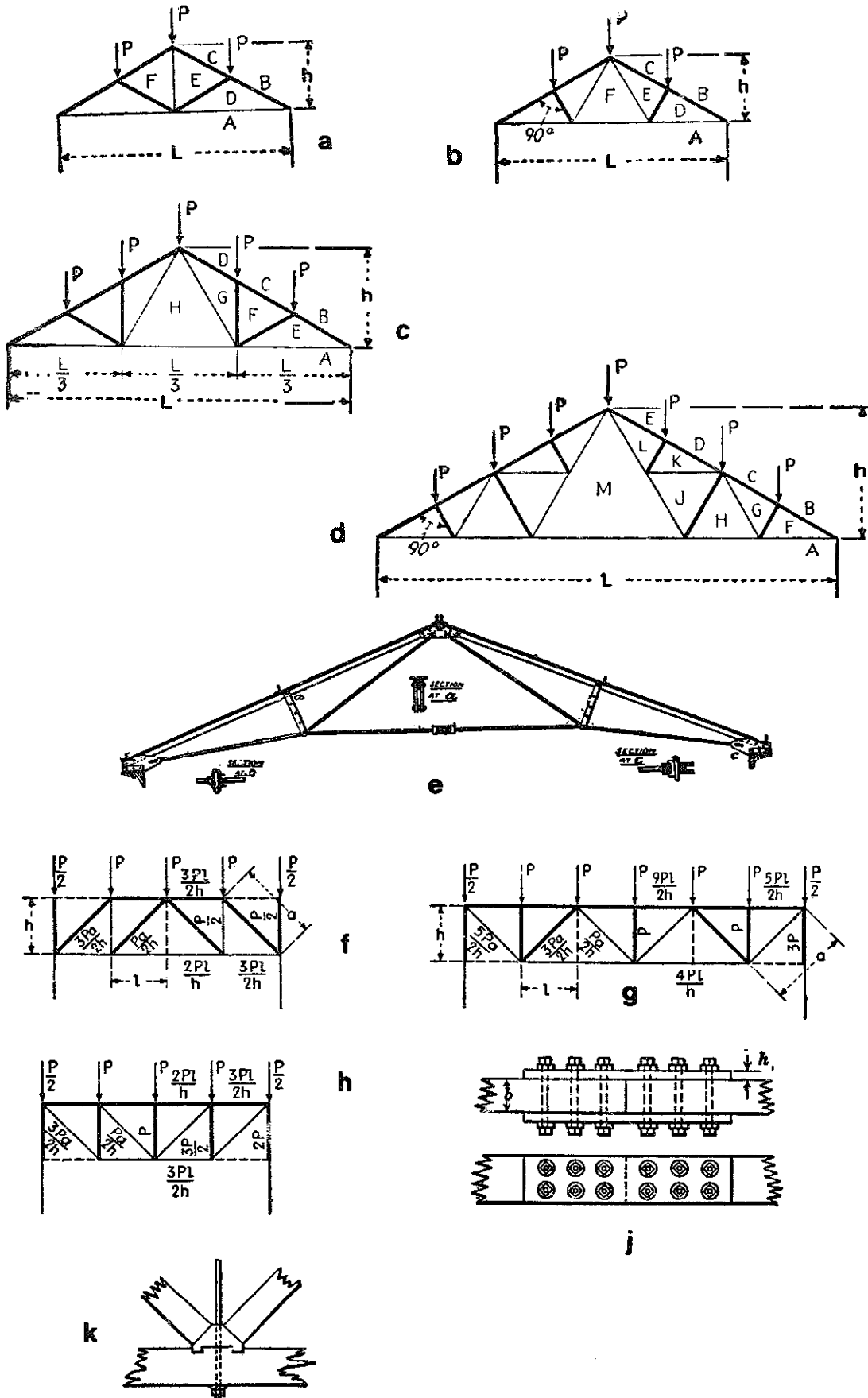

A—Structures

6-BRIDGES

a-Single-strut deck truss for short spans up to 40 feet.

b-Double-strut deck truss for spans up to 70 feet.

c-Multiple-strut deck truss for spans up to 100 feet.

d-Truss with interpanel tie rods. (Whipple)

e-Truss in which the vertical and end posts are struts; it has vertical tie rods from the end posts and diagonal tie rods in the panels. (Whipple)

f-Truss with vertical struts, except in the end panels which have vertical tie rods, with inclined end struts and diagonal tie rods.

g-Arch-deck truss bridge.

h - T r u s s with inclined strut and tie rod for each panel, with stiff compression upper chord, the vertical members being tie rods.

j-Truss with inclined posts and vertical tie rods. (Baltimore model)

k-Arch-truss bridge.

l-Truss, having vertical end posts with inclined struts meeting at the center. (Post)

m-Swing bridge. (Whipple)

n-Swing bridge. (Post)

o-Cantilever bridge.

p, q, r-Suspension bridges.

s-Steel-arched concrete bridge. (Thatcher type)

t-Rolling lift bridge. (Chicago type)

u-Truss (combination of "Whipple" and "Warren System").

v-Brooklyn-New York bridge. (Roebing suspension system)

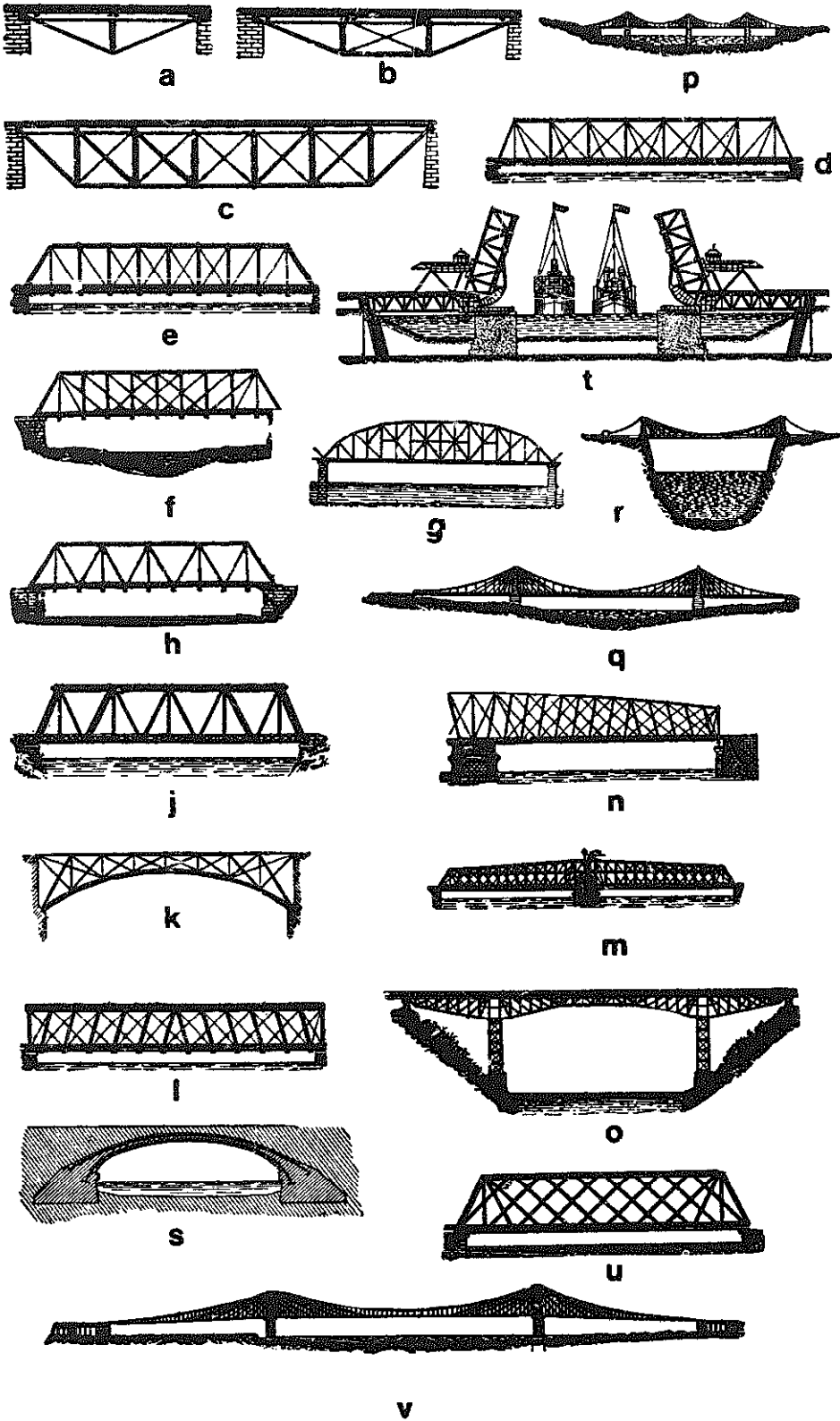

## VII STRUCTURAL ENGINEERING

### A—Structures

#### 7--WELDED JOINTS

- a--Welding arrangement.
- b**--Shielding of the arc and slag protection of weld metal while cooling.
- c-Electric welding.
- d--Example of welds and locations.
- e-Square groove joint.
- f-Single-U groove joint.
- g-Double-U groove joint.
- h-Single fillet lap joint.
- j-Double fillet lap joint.
- k-Double bevel groove joint.
- l--Single bevel groove joint.
- m-Double bevel groove joint.
- n-Single-vee groove joint .
- o-Double-vee groove joint.
- p-Single-J tee joint.
- q-Square tee joint.
- r--Finish comer joint.
- s--Half open corner joint.
- t-Oxygen and acetylene torch for cutting steel.
- u-Staggered intermittent fillet welds.

# WELDED JOINTS

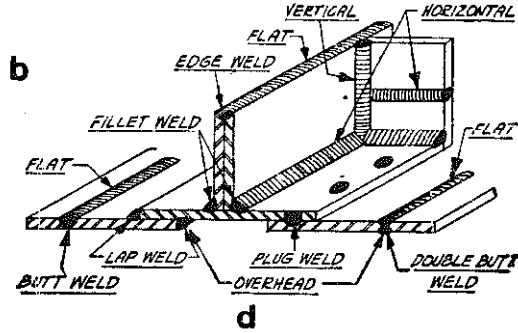
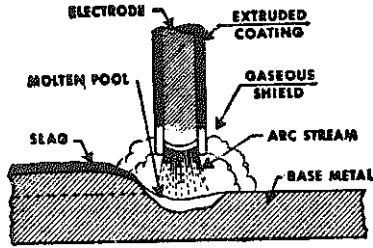
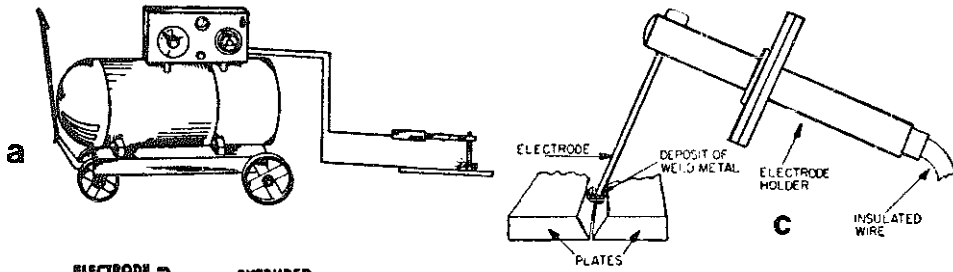

e

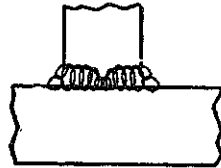

k



i

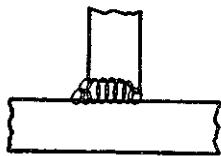

p



f

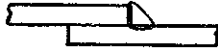

h



m



q



g

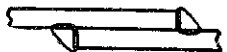

j



n



o



r



s

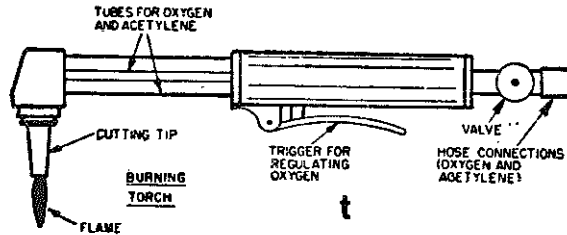

t

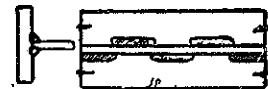

u

A-Structures

8—MASONRY AND CONCRETE

- a-compressed concrete pile.
- b-Sheathing bracing of excavations.
- c—Wood forms for concrete foundation wall.
- d—Hollow tile floor arches.
- e—Mortar joint; weathered.
- f-Mortar joint; struck.
- g-Mortar joint; flush cut.
- b-Mortar joint; concave.
- j-Mortar joint; convex.
- k-Mortar joint; V-tooled.
- L-Mortar joint; stripped.
- m-Mortar joint; rodded.
- n-Mortar joint; raked out.
- o—Ionic column.
- p-Corinthian column.
- q—Doric column.
- r-Roman column.
- s-Reinforced concrete columns.
- t-Concrete slab supported by steel beams.
- u-Slab supported by concrete beams.
- v-Face brick laid in common or American bond.
- w-English brick bond.
- x-Flemish brick bond.
- y-Stone work; coursed ashlar.
- z-Stone work; broken ashlar.
- aa—Stone work; rubble with dressed joints.
- bb-Stone work; rubble with undressed joints.



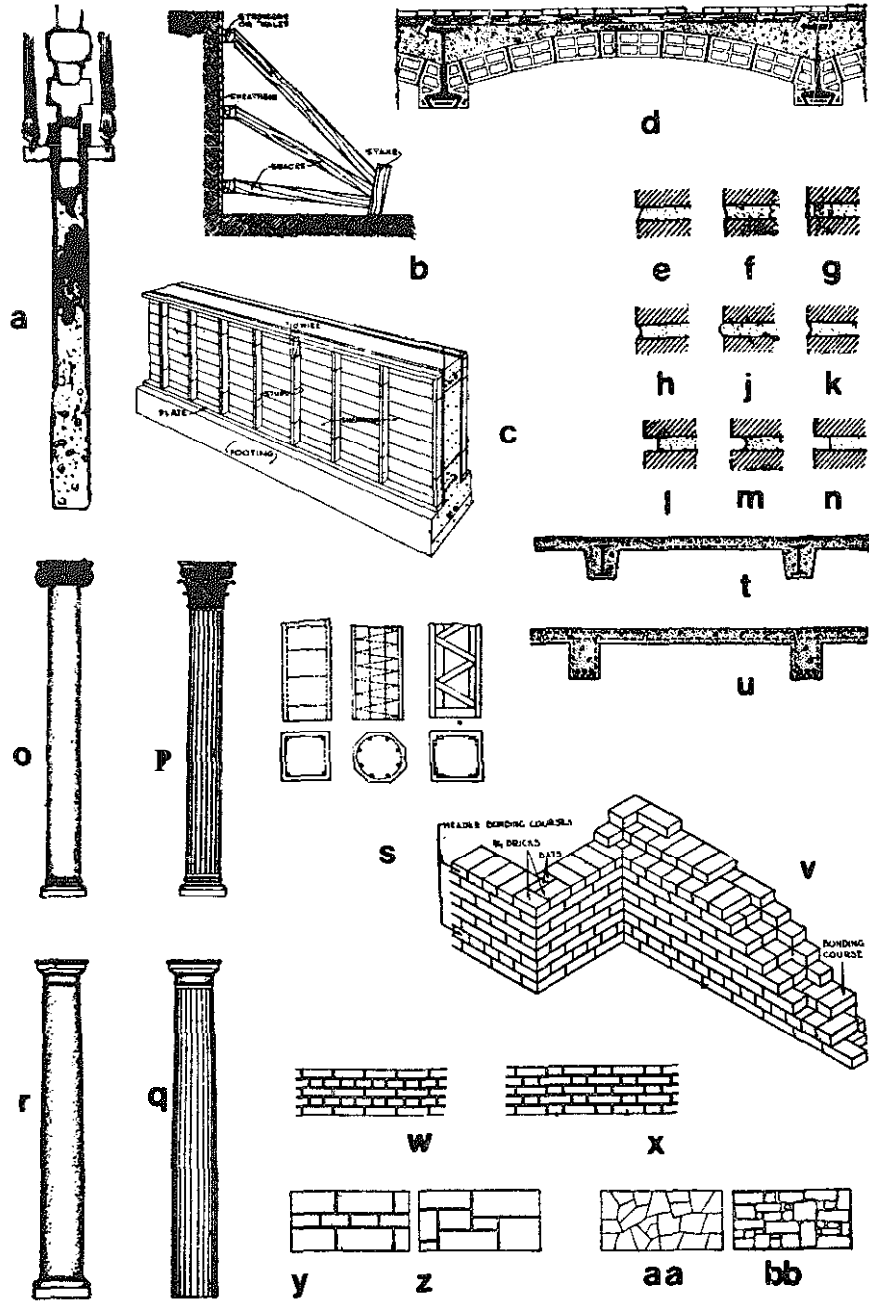

**B-Cranes, Derricks and Elevators**

**1-CRANES**

**a-Gantry crane;** similar to an overhead traveling crane, except that the bridge for carrying the trolley or trolleys is rigidly supported on two or more movable legs running on fixed rails, or other runway.

**b-Semigantry crane** with one end of the bridge rigidly supported on one or more movable legs running on a fixed rail or runway, the other end of the bridge being supported by a truck running on an elevated rail or runway.

**c-Cantilever gantry crane;** the bridge girders or trusses are extended transversely beyond the crane runway on one or both sides; its runway may be on the ground or elevated.

**d-Hammer-head crane;** a rotating counterbalanced cantilever equipped with one or more trolleys and supported by a pivot or turntable on a traveling or fixed tower.

**e-Overhead traveling crane** on a pair of parallel elevated runways, adapted to lift or lower a load and to carry it horizontally and parallelly or at right angles to the runways; it consists of one or more trolleys, operating on the top or bottom of a bridge, which consists of one or more girders or trusses mounted on trucks operating on the elevated runway.

**f- L o c o m o t i v e crane** consisting of a self-propelled car, operating on a railroad track, on which is mounted a rotating body supporting the power-operated mechanism, together with a boom which can be raised or lowered at its head (outer end), from which end a wire rope is led for raising or lowering the load.

**g-Crawler crane** of the locomotive-crane type mounted on a tractor frame instead of on a railroad car, using tractor or caterpillar belts or treads for locomotion in any direction.

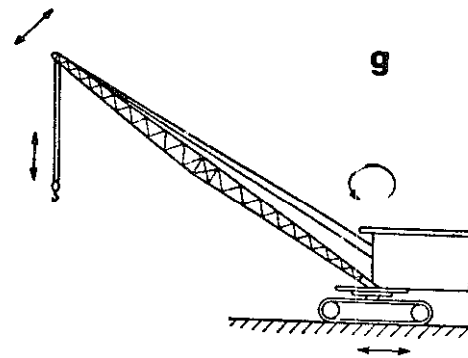
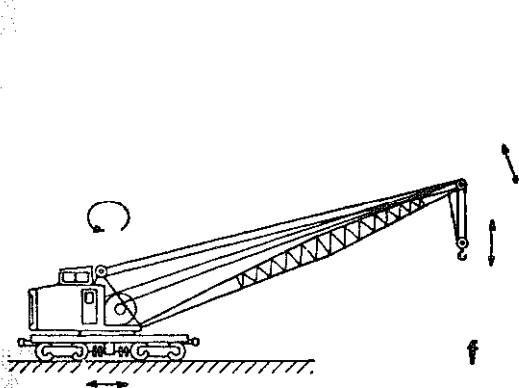
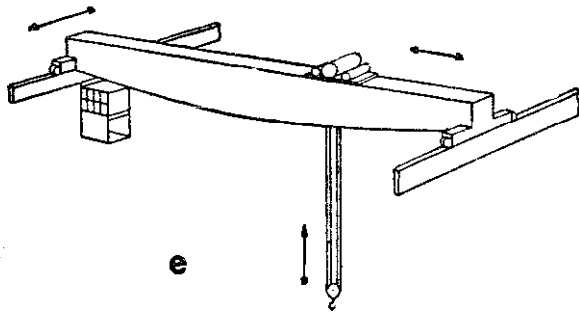
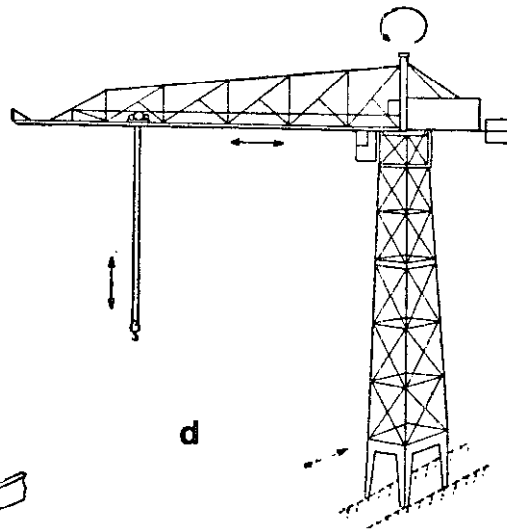
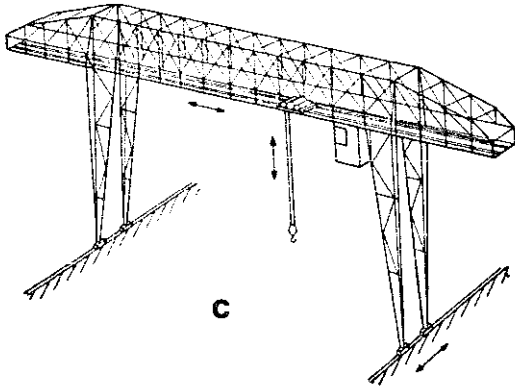
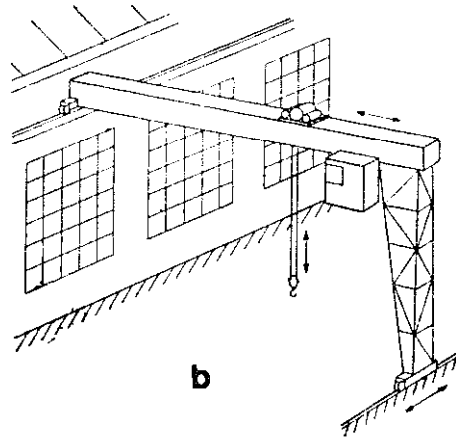
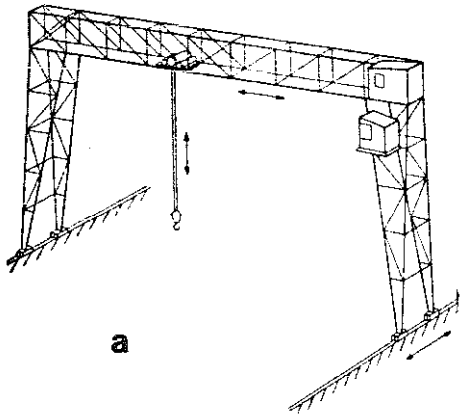

**B-Cranes, Derricks and Elevators**

**2-DERRICKS**

**a-A-frame derrick** in which the boom is hinged from a cross member between the bottom ends of two upright members spread apart at the lower ends and united at the top; the upper end of the boom is secured to the upper junction of the side members and the side members are braced or guyed from the junction point.

**b-Breast derrick** without a boom; the mast consists of two side members spread farther apart at the base than at the top, tied together at top and bottom by rigid members, the top held from tipping by guys, and the load raised and lowered by ropes through a sheave or block secured to the cross piece.

**c-Shears** with winch or tackle blocks.

**d-Gin-pole derrick;** consists of a mast, with guys from its top so arranged as to permit leaning the mast in any direction, the load being raised or lowered by ropes leading through sheaves or blocks at the top of the mast.

**e-Stiff-leg derrick** similar to a guy derrick except that the mast is supported or held in place by two or more stiff members capable of resisting tensile or compressive forces; usually sills connect the lower ends of the two stiff legs to the foot of the mast.

**f-Fixed guy derrick,** the mast can be rotated; it is supported in vertical position by three or more guys and a boom whose bottom end is hinged or pivoted to move in a vertical plane, with lines between the head of the mast and the head of the boom for raising and lowering the boom, and lines from the head of the boom for raising and lowering the load.

# DERRICKS

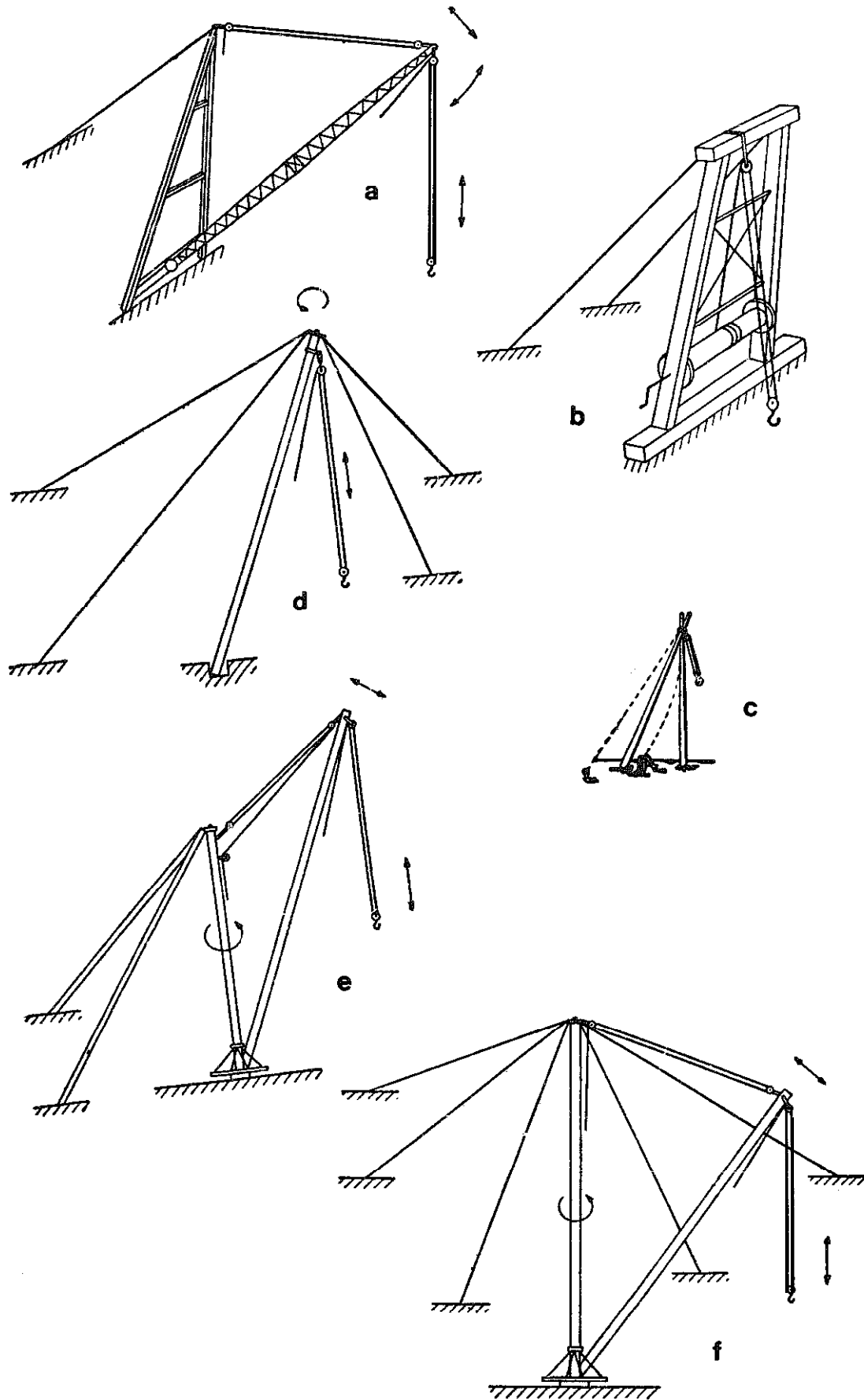

**B—Cranes, Derricks and Elevators**

**3—ELEVATORS AND CONVEYORS**

**a-Track hopper** and apron feeder with gravity discharge and bucket elevator.

**b-Centrifugal discharge-type bucket elevator** on chain or belt; loaded by material flowing into bucket, or, by their digging or scooping it up under the foot wheel; the material is discharged by centrifugal action as buckets pass over the head wheel.

**c-Perfect discharge-type bucket elevator** on double-strand chain; the buckets are carried between two chains, snubbed under head wheels to inverted position over the discharge chute; it operates successfully at low speeds for handling fragile, sticky, powdered or fluffy materials.

**d-Continuous bucket elevator** on single-strand chain or belt; spillage between buckets is prevented by their close spacing; and at the sides and front by a loading leg; the receiving chute is slightly narrower than the buckets and is so placed that there is always one bucket in the receiving position below the bottom of the receiving chute.

**e-Super-capacity continuous bucket elevator** on double-strand chain; the buckets and the operation are similar to those of "d".

**f-V-bucket carrier**, functioning as elevator and conveyor.

**g-Peck carrier** for coal, ashes, gravel, stone, clinker, etc.; it consists of buckets, pivotally suspended between two endless chains; as the buckets maintain their carrying position by gravity, at all times, a single carrier can transport material horizontally, vertically and again horizontally, or in any desired path (within a vertical plane of travel); 36-inch pitch peck carrier is shown with 36-inch wide bucket. (Link-Belt Co.)

**h-Inclined continuous bucket elevator** for sand, gravel and stone, using medium front steel buckets on chain; it has no casing.

**j-Pivoted bucket carriers** are used for elevating and conveying material that will not stick to the buckets; they require less power than V-bucket carriers as the material is carried and not dragged on the horizontal run; the material is usually automatically fed on the lower horizontal run, elevated and discharged by a bucket-tripping device on the upper horizontal run.

**k-Gravity discharge elevator conveyor** with V-bucket carriers. Used for coal and other non-abrasive material.

# ELEVATORS & CONVEYORS

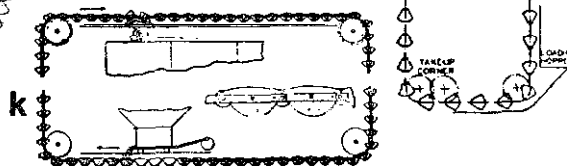
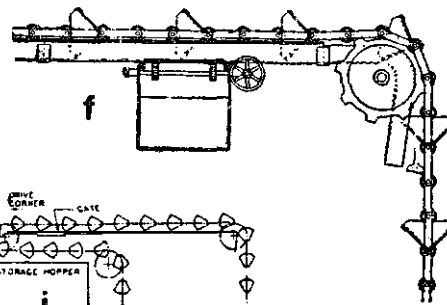
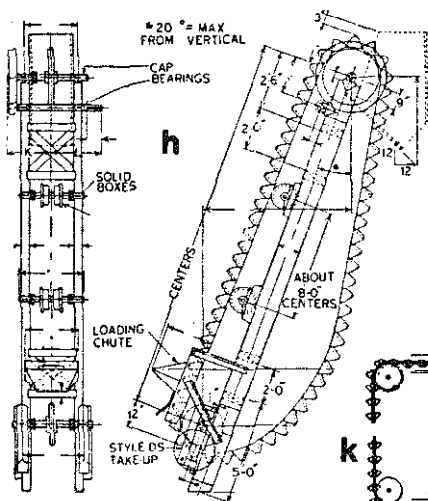
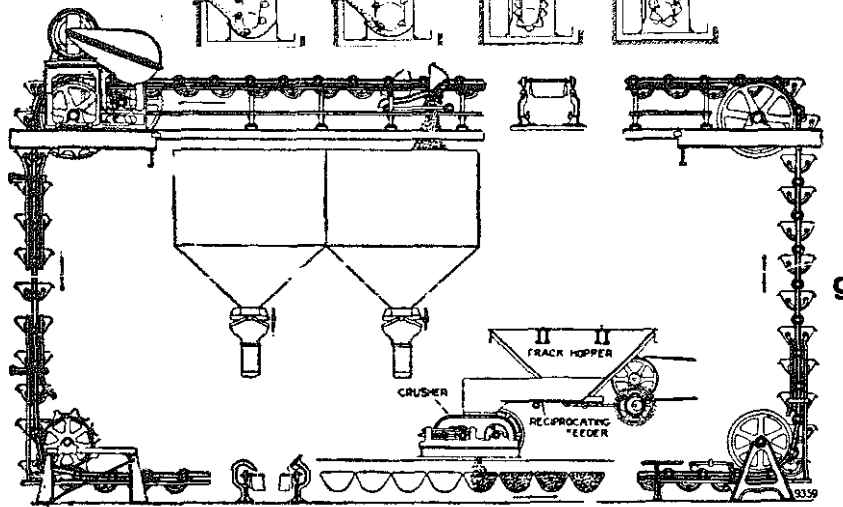
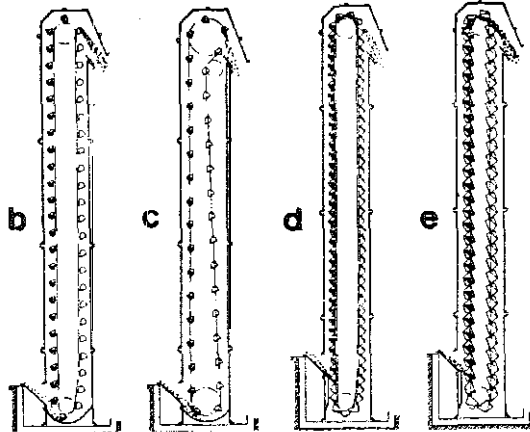
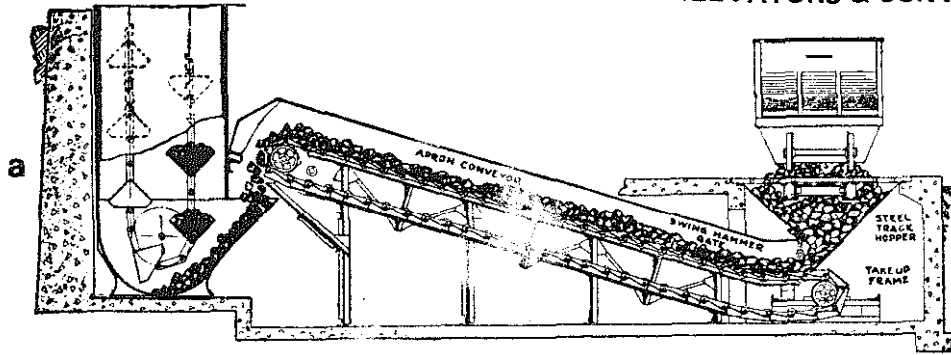

**B-Cranes, Derricks and Elevators**

**4-HOISTS, AND DETAILS**

**a-Worm-gear hoist.** a, operating chain; b, pocket sheave; c, worm-shaft; d, load sheaves (2).

**b-Electric Hoist.** a, motor; b, rope drum; c, casing; d, cover for solenoid motor brake; e, controller; f, pendant grips; g, limit switch weight.

**c-Air motor hoist.** a, air engine; b, drum; c, worm and worm gear; d, spur gears.

**d-Double-purchase crab.** A hand-powered hoisting device.

**e-Hoisting drum.** a, guide rollers; b, screw drive to move rollers a; c, chain sprocket drive.

**f-Direct-acting (pneumatic) hoist..**

**g-Hydraulic jack.** Piston draws fluid from reservoir through valve into the bottom section, thus raising the head.

**h-Rack and lever jack.**



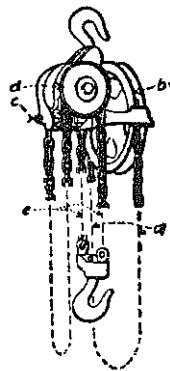

a

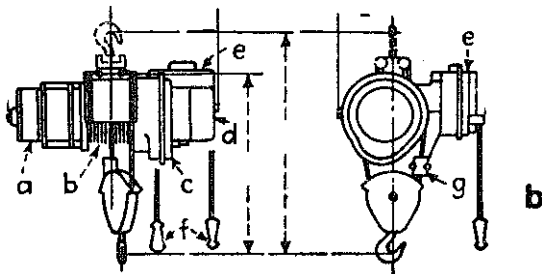

b

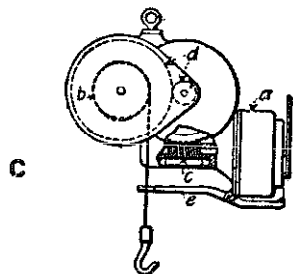

c

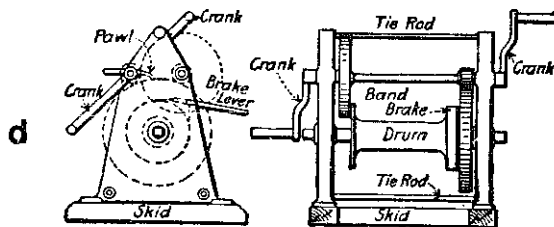

d

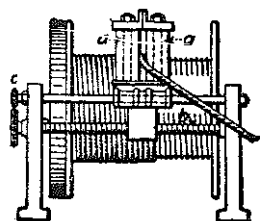

e



f

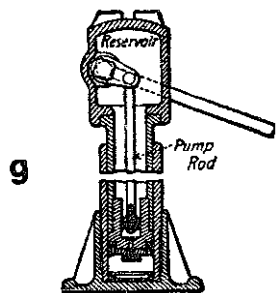

g

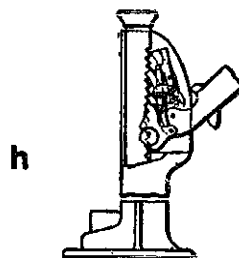

h

B-Cranes, Derricks and Elevators

5--KNOTS AND HITCHES. Hitch is a knot used to form temporary loop or noose in a line.

a-Simple overhand knot.

b-Figure 8 knot.

c-English knot.

d-Round turn and hitch.

e-Moorish knot.

f-lark's bead knot.

g-Simple boat knot.

h-Timber hitch.

j-Splice with thimble.

k-Splice with thimble and shackle.

l-Clove hitch.

m-Slippery clove hitch.

n-Timber hitch.

p-Killick hitch.

q-Double lark's head.

r-Rolling hitch.

s-Stopper hitch.

t-Lifting hitch.

u-Lifting hitch with strap.

v-Two half hitches.

w-Round turn and two half hitches.

KNOTS & HITCHES

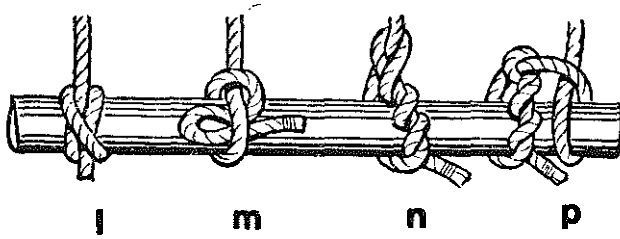
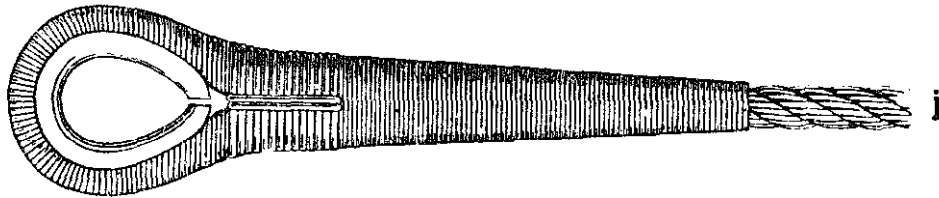
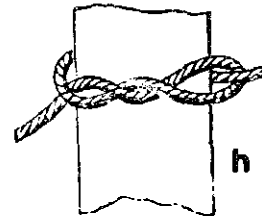
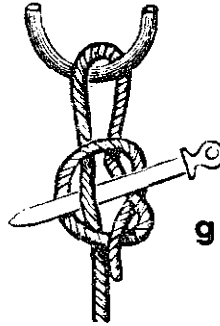
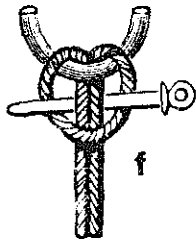
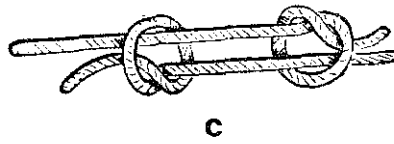
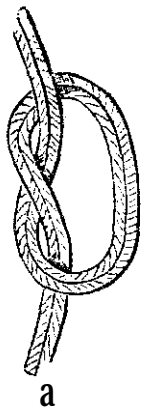

m

n

p

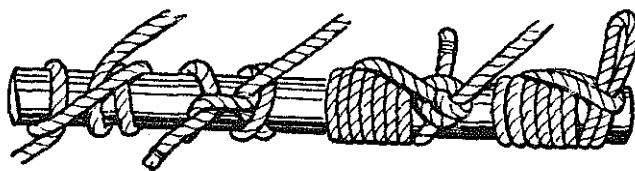
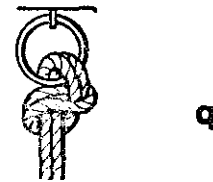

s

t

u

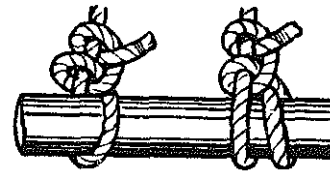

w

B-Cranes, Derricks and Elevators

6-ACCESSORIES

a-Lifting magnet and cable take-up.

b-Hayward grab bucket. a, holding rope; b, closing rope; c, chain; d, drum. Used for gravel, sand and coal. Shown in open position.

c-Same as "b" but in closed position.

d-Williams grab bucket open position. a, holding rope; b, closing rope; c, d, sheaves; e, shell.

e-Same as "d", but closed.

f-Lifting tongs. Used for straw etc.

g-Lifting tongs for plates etc. a, cams.

h-Hoisting a small plate on edge.

j-Method of lifting a pipe vertically.

k-Barrel-end lifting hooks for hoist.

l-Hoisting a flat plate with a rope sling.

m-Beam and sling for hoist.

n-Single tongs.

p-Bale and clamp hook.

q-Movable hook-beam.

r, s, t-Variou crane hooks.

u-Typical hoist chain.

ACCESSORIES

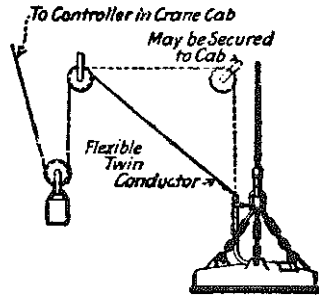

a

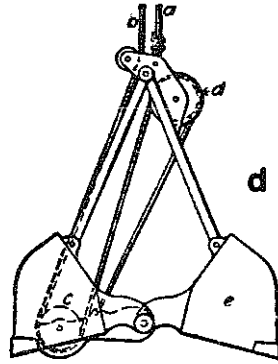
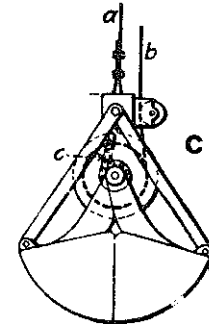
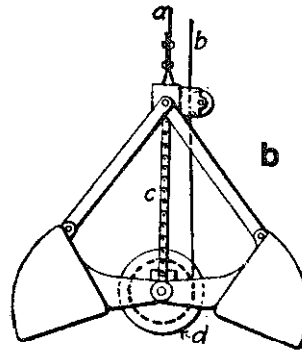

d

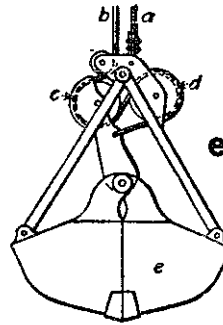

e

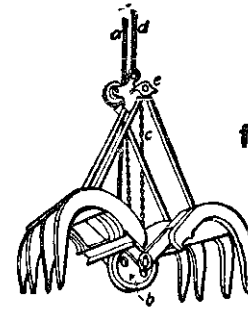

f

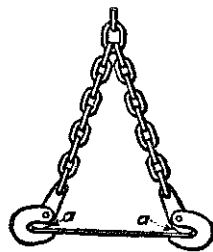

g

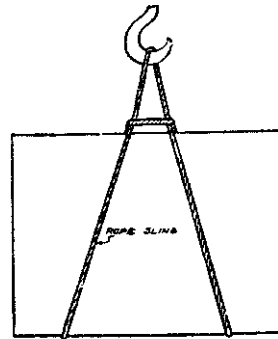

h

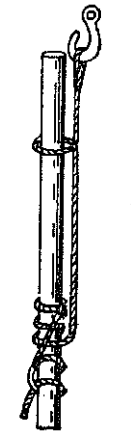

j

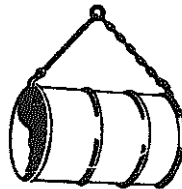

k

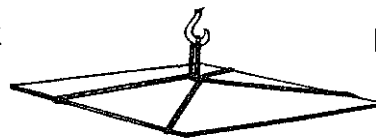

l



m

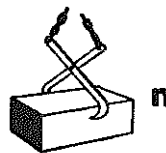

n



u

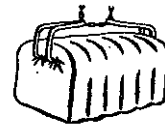

p

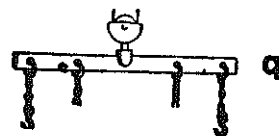

q



r



s



t

VIII COMFORT HEATING AND COOLING

## A—Refrigeration

**I-SYSTEM CLASSIFICATION.** These are divided into classes, according to the method of extracting heat.

**a-Direct System.** In this type the evaporator is in direct contact with the space to be refrigerated, or the material, or is located directly in passages where the air communicates directly with these mentioned spaces.

**b-Indirect open-spray system.** In this system the evaporator is located in an enclosure external to the cooling chamber. Water or a brine solution are cooled by the evaporator and piped (circulated) through the cooling chamber and sprayed therein. A pump circulates the brine.

**c-Indirect closed surface system.** Here the liquid (brine or water) is cooled in an evaporator located in an enclosure outside of the cooling chamber. Liquid is piped through cooling chamber in a closed circuit.

**d-Indirect, vented closed surface system.** In this system the evaporator is located in a vented enclosure external to the cooling chamber. The liquid (brine or water) is cooled by the evaporator and circulated through the cooling chamber in a closed circuit.

**e-Double indirect vented open-spray system.** The liquid (brine or water) is cooled by an evaporator located in a vented enclosure, from where it is circulated through a closed loop to a second enclosure. There the brine cools another liquid, such as brine or water, and this new liquid is now circulated to a cooling chamber and sprayed therein.

SYSTEM CLASSIFICATION

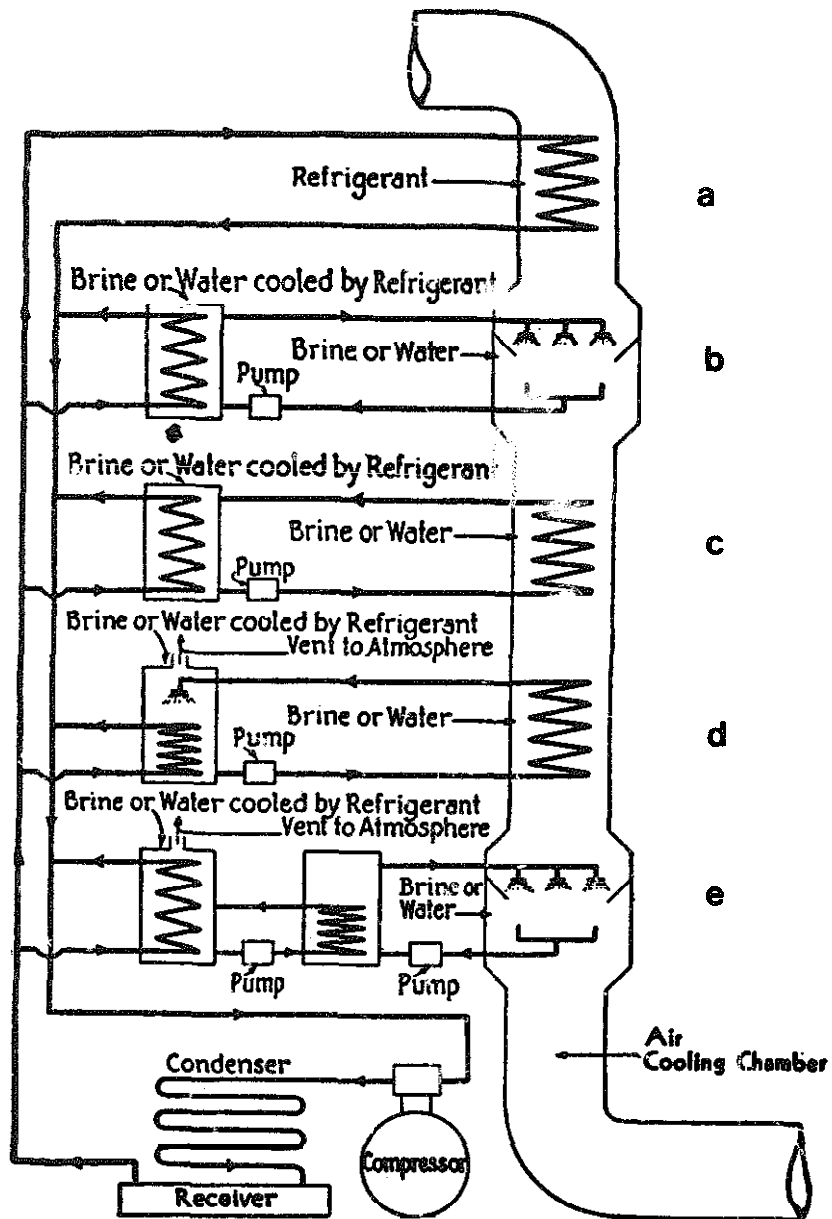



## A—Refrigeration

### 2—HOME REFRIGERATION

**a-Aircooled Servel refrigeration cycle.** The unit is charged with a small quantity of aqua-ammonia, and hydrogen. With heat applied ammonia vapor rises to separator. Hot ammonia vapor continues to condenser, and is liquified by cooling. Natural convection keeps steady air flow over finned condenser. The liquid ammonia flows into the evaporator. Hydrogen gas hits liquid ammonia in evaporator, with evaporation at low partial pressures. Ammonia returned from generator hits the gas mixture entering the absorber, ammonia is dissolved and hydrogen returns to evaporator. Solution from absorber is returned to generator.

**b-Refrigerator.** Shown is a cycle in a home type refrigerator. The compressor takes the returning vapor at low pressure, compressing it to a high pressure. Vapor enters the condenser, where it is cooled and becomes a liquid. This liquid flows through the line up to the filter, the capillary tube into the evaporator, where it is under light pressure, changing into a vapor. Refrigerant boils rapidly, absorbing heat. The vaporized refrigerant is drawn through the suction line back to the compressor. From there the cycle repeats.

**c-The Capillary tube** receives refrigerant from the condenser. The capillary tube is designed to maintain a pressure difference while the compressor operates.

**d-Compressor** takes in heat laden refrigerant vapor from freezer; intake flapper valve is open.

**e-compressed refrigerant** vapor is forced into the condenser.

**f-Rotary compressor.** Shown is the pumping effect where low pressure vapor is taken in. At high temperature, high pressure vapor is produced by rotary motion.

**g-Sealed Unit** showing motor and rotary compressor.

# HOME REFRIGERATION

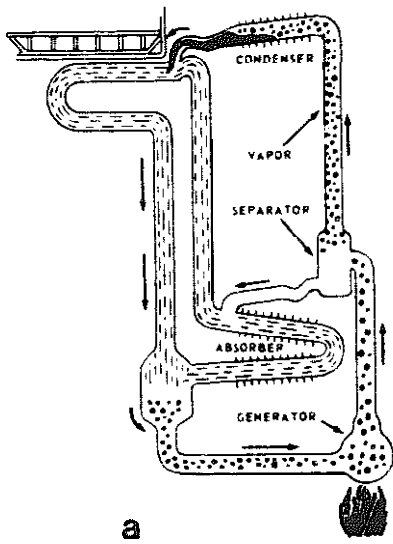

Refrigerant from condenser enters capillary tube.

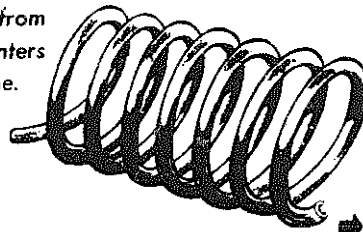

c

"Metered" liquid refrigerant leaves capillary to go to freezer.

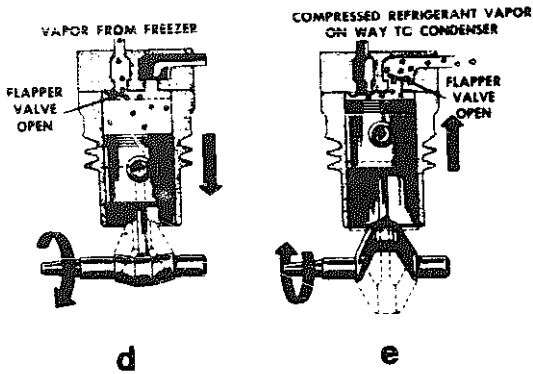

d

e

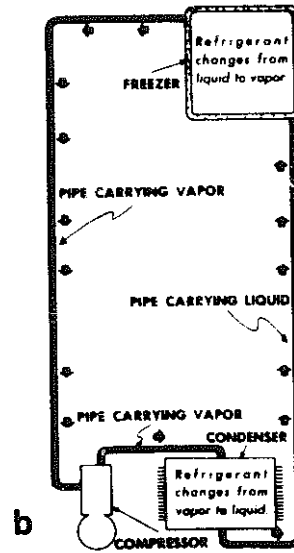

b

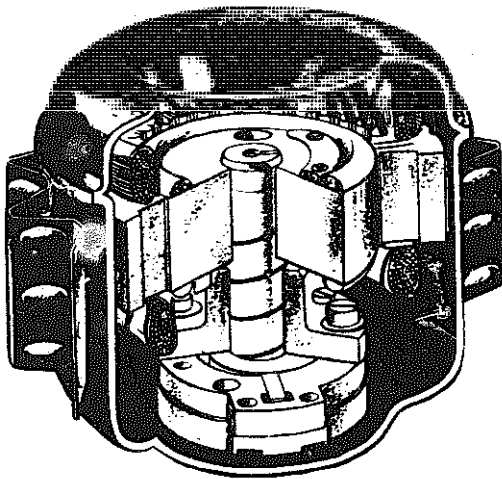

g

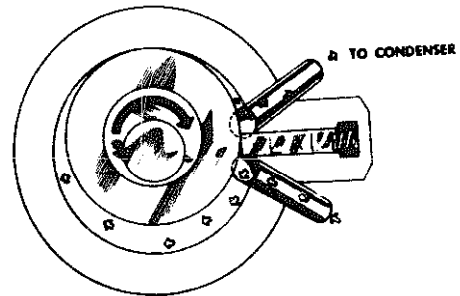

f

**B-Air Conditioning**

**1 -AIR CONDITIONING (LARGE UNIT)**

**a-Air Conditioning; with compression refrigeration,** when mechanical means are used, the system may be an ordinary direct expansion system, a steam-jet system or a water-vapor system; the most common type is that employing direct expansion, where a power-driven piston-type compressor is used to compress the gas; a condenser to liquefy the gas, and a cooling coil in which the gas expands after entering the coil through an orifice, e.g., an expansion valve; various other accessories are added, such as a receiver, an oil separator, a liquid trap, etc.; Freon is most commonly used in such systems as a refrigerant, although ammonia is a more efficient refrigerating medium.

# AIR CONDITIONING (LARGE UNIT)

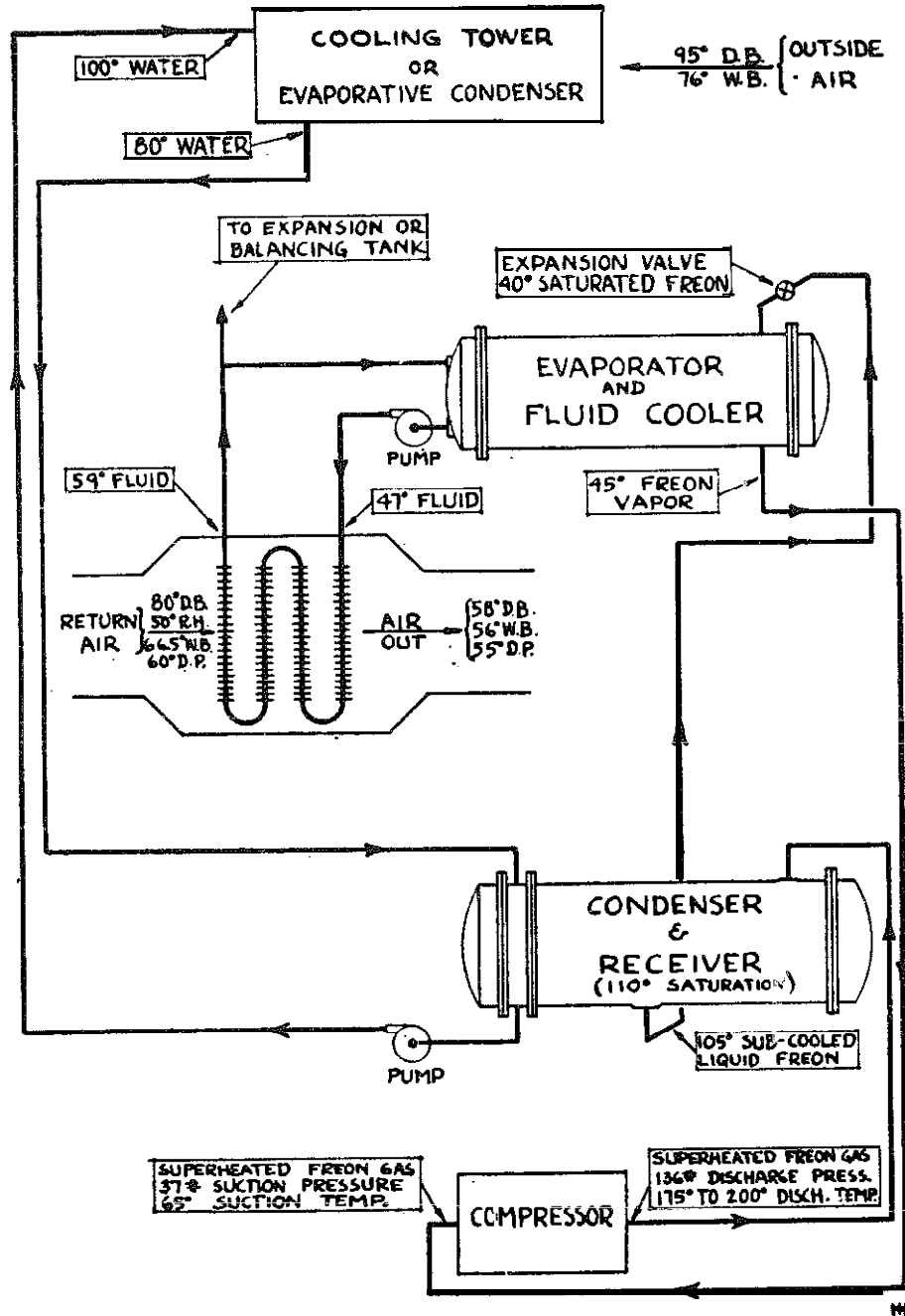

a

**B-Air Conditioning**

**2-HOME AIR CONDITIONERS AND HUMIDIFIERS**

**a-Window air conditioning unit**, basic. The functions of the parts are the same as in refrigeration machines. Outside of the window are located condenser B, motor-compressor unit C, and fan motor E. Inside the room we have evaporator coils A, and filter D.

**b-Actual unit**, similar to "a".

**c-Propeller fan room cooler**, suspended from ceiling. Only the refrigerant, the expansion valve the evaporator and pipes to them, are in the room.

**d-Humidifying unit** for warm-air furnace.

**e-Surface-type cooling unit**.

**f-Brine spray cooling unit**.

**g-Self-contained all year round air-conditioner** with watercooled refrigerating condenser and compressor.

**h-Remote floor type room-unit air-conditioner**.

**j-Spray-type unit humidifier** with steam coil to preheat the air for residences.

**k-Steam pan humidifier**.

**l-Steam grid humidifier**.

# HOME AIR CONDITIONER & HUMIDIFIER

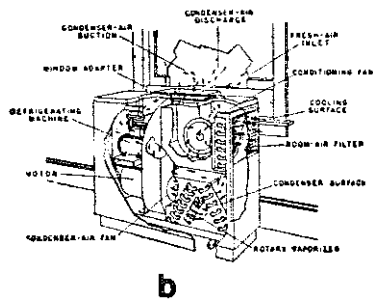

**b**

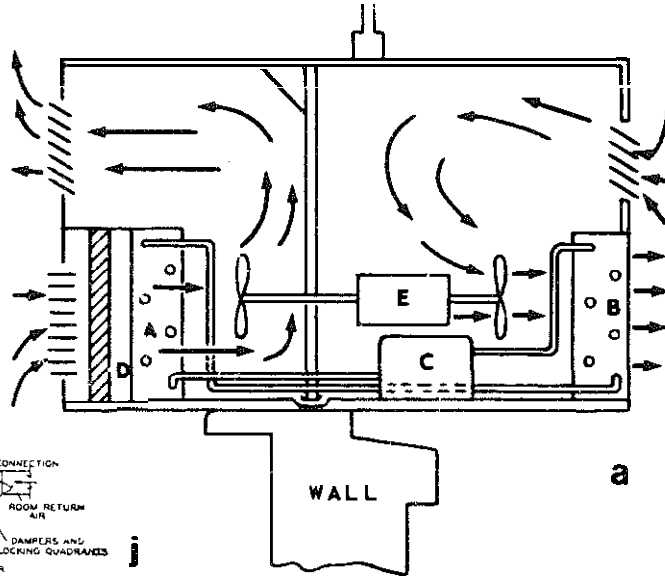

**a**

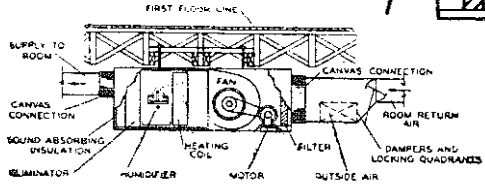

**j**

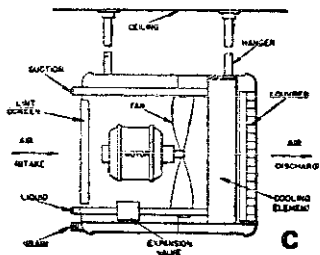

**c**

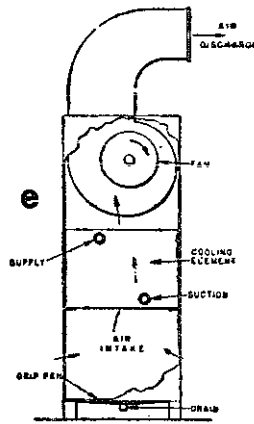

**e**

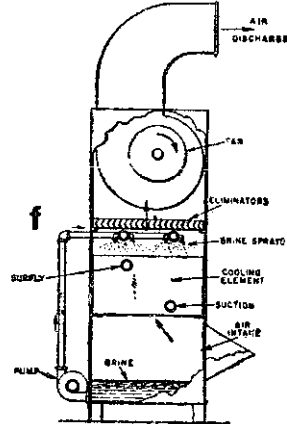

**f**

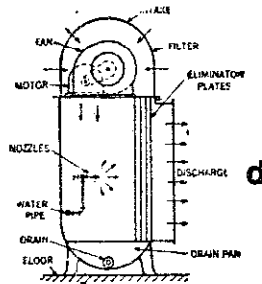

**d**

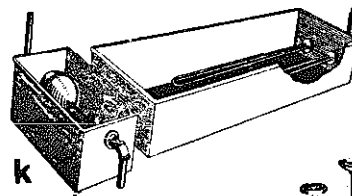

**k**

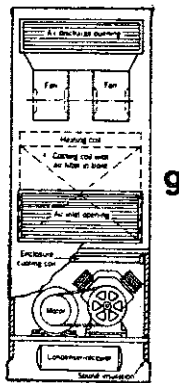

**g**

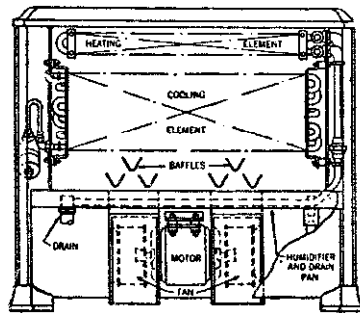

**h**

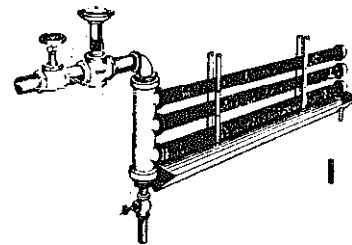

## B—Air Conditioning

### 3—CAR AIR CONDITIONERS

**a—Add-on air conditioner.** Special brackets are furnished. A, condenser; B, compressor; C, condenser mounting straps; D, discharge hose; E, liquid hose; F, receiver-drier; G, liquid hose; H, suction hose; I, evaporator hanger bracket; K, evaporator; L, condensate drain hose. (Climatic Air Sales Inc.)

**b—All season air conditioning system,** combining heating, cooling, ventilating and defrosting, in one single unit. (American Motors Corp.)

**c—Schematic,** showing condition of refrigerant in air conditioning system. (Ford Motor Co.)

CAR AIR CONDITIONERS

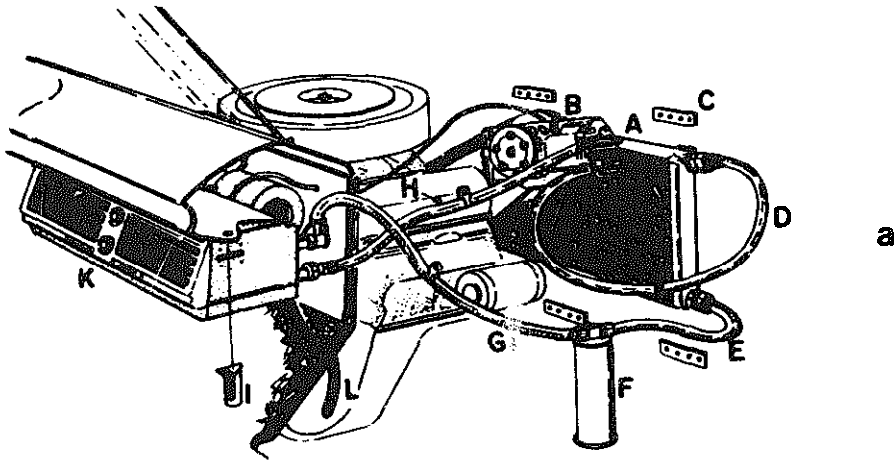

a

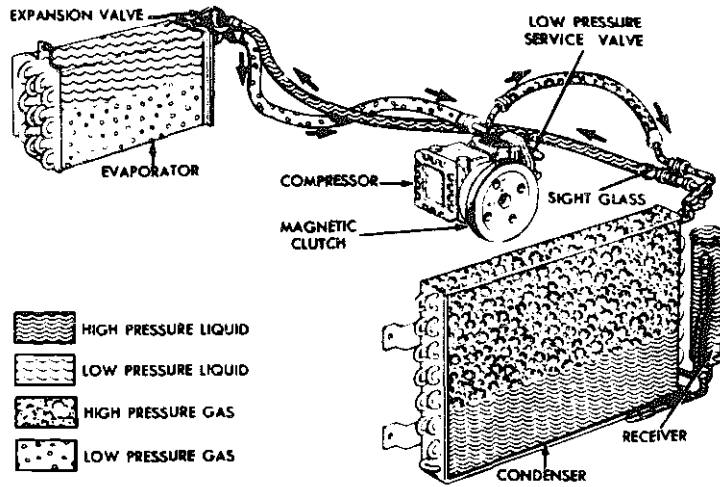

c

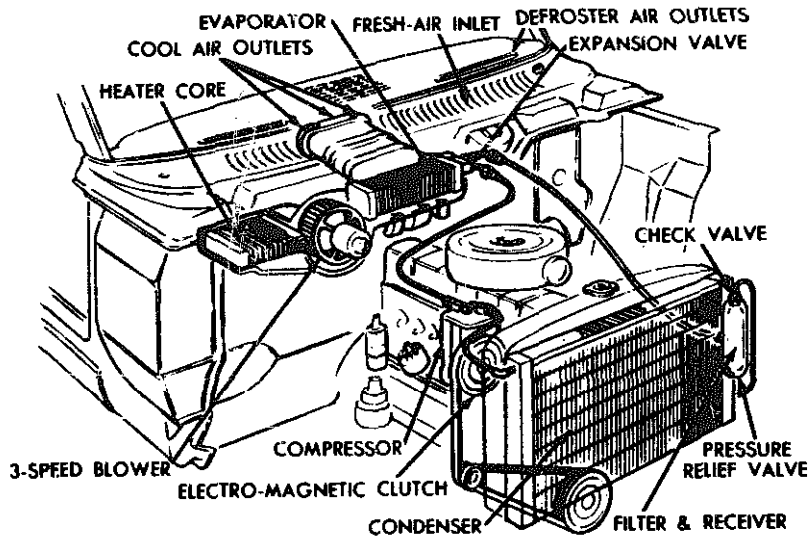

b



## VIII COMFORT HEATING AND COOLING

### B-Air Conditioning

#### 4-UNIT AIR CONDITIONERS

**a-Humidifying unit** for steam-radiator-heated homes.

**b-Oil-fired air-conditioning unit.**

**c-Air-conditioning unit** with top inlet and outlet.

**d-Residential, central Carrier year-round air-conditioning unit** equipped for gas burning with steam boiler, refrigerating coil, and heating coil.

UNIT AIR CONDITIONERS

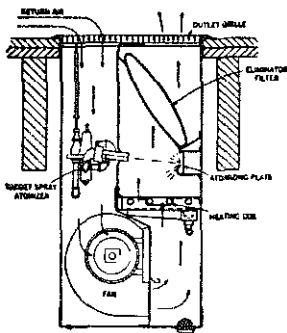

a

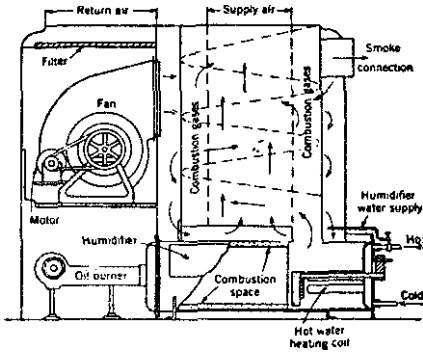

b

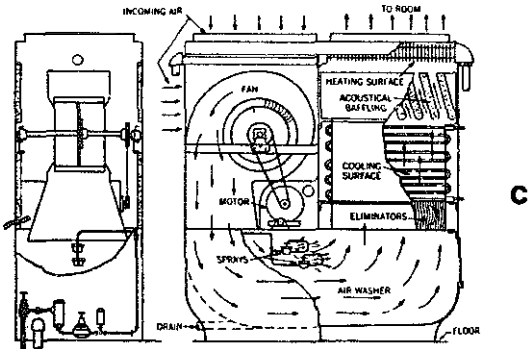

c

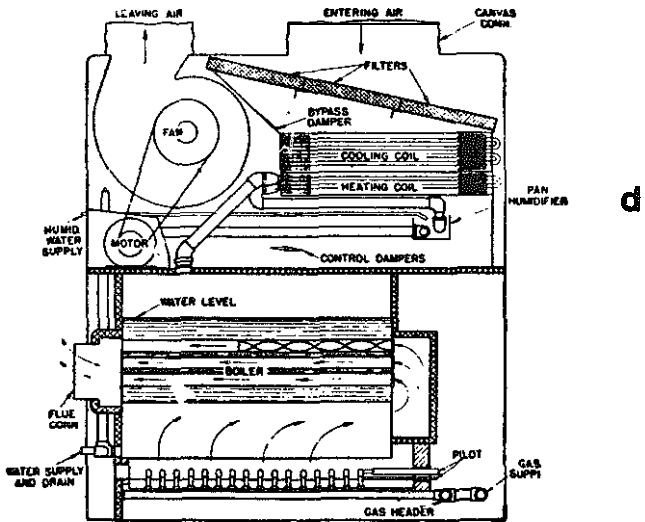

d

**B-Air Conditioning**

**5-AIR ANALYSIS**

**a-Principle of the sling psychrometer.** The dry bulb and wet bulb thermometers are regular thermometers, but the wet bulb thermometer has a moist cloth surrounding the bulb. When whirling it, the wet bulb will read less due to evaporation.

**b-Psychrometric chart.** This is a graph of the temperature-pressure relationship of water vapor. The horizontal scale is the dry bulb temperature, and the vertical scale is the water vapor pressure scale.

**c-Aspirating psychrometer;** this particular unit is battery powered, and the thermometers are illuminated. A small motor-fan combination draws air over the wet and dry bulb thermometers.

**d-If two properties of the air are known, the others can be found.** Wet bulb temperature is read at the intersection of wet-bulb line with the 100% relative humidity line. The dry-bulb temperature is read on the vertical line.

**e-The relative humidity** is read from the curved line.

**f-The dew-point temperature** is read at the intersection of a horizontal line of given moisture content with the 100% humidity line.

**AIR ANALYSIS**

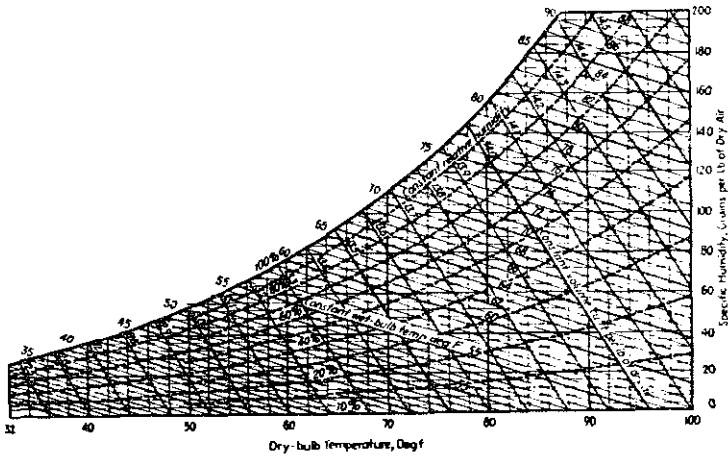

**b**

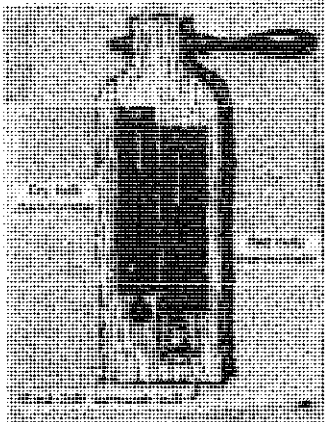

**a**

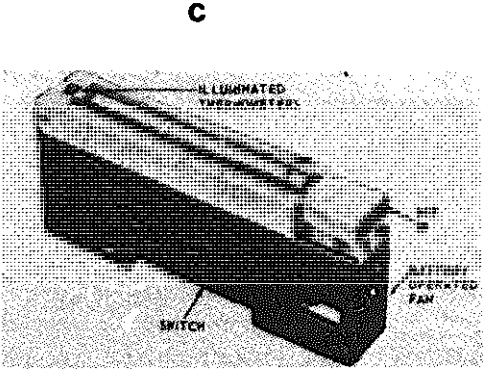

**c**

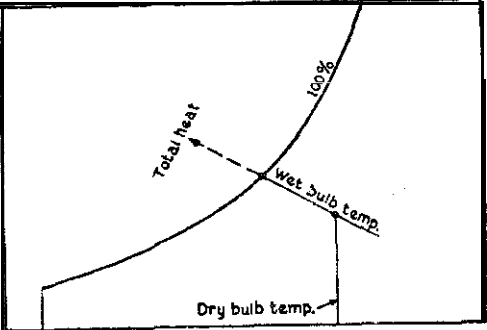

**d**

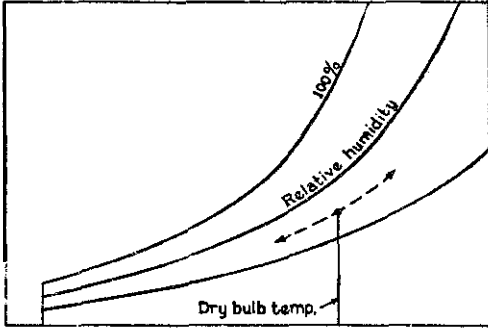

**e**

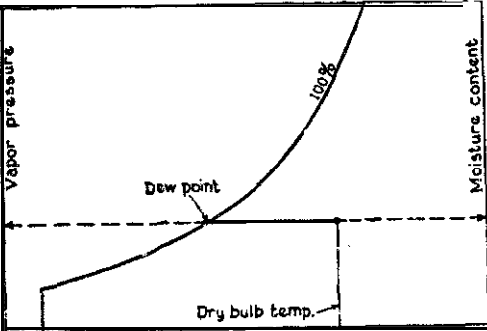

**f**

## C-Steam Heating

### 1--STEAM-HEATING HOOKUPS

**a-Vapor heating system;** two-pipe up-feed shown; the radiators discharge condensate to the dry return pipe; these systems operate at a few ounces pressure and above, but those with mechanical return devices may operate at pressures up to 10 psig; control of heat is obtained by varying the opening of the graduated radiator valve; the boiler is maintained at a constant pressure slightly above atmospheric.

**b-Vacuum heating system;** a vacuum is maintained in the return line at all times; the pump is usually controlled by a vacuum regulator which operates the pump to maintain the vacuum within limits in response to a pressure difference between the atmosphere and the vacuum in the return main.

# STEAM-HEATING HOOKUPS

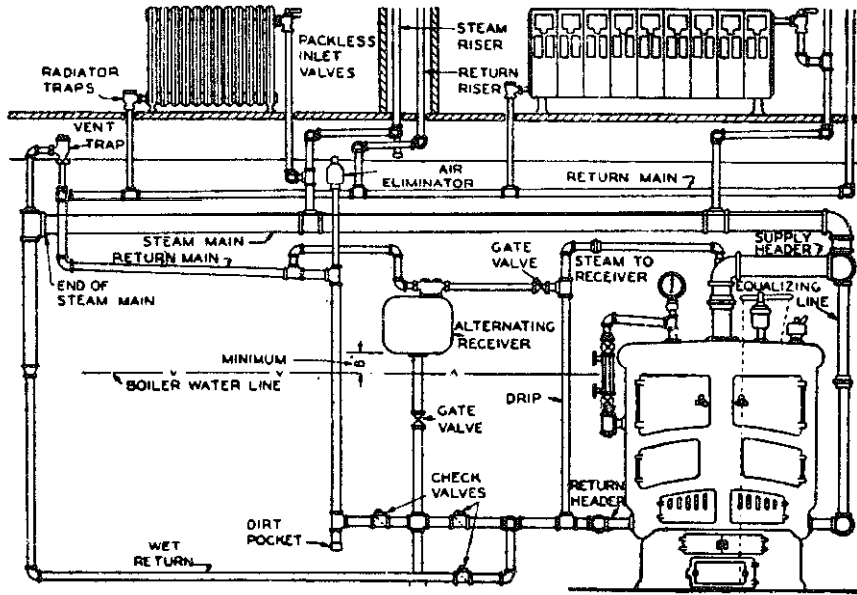

a

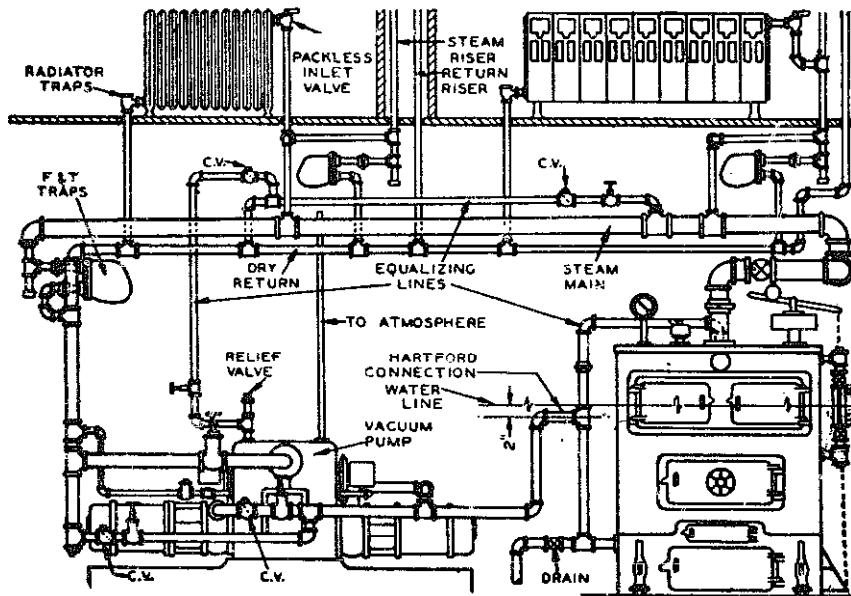

b

**C-Steam Heating**

**2-STEAM-HEATING HOOK-UP DETAILS**

**a**-Arrangement of a **Strainer** ahead of the trap.

**b**-Arrangement of a **dirt pocket** ahead of the trap.

**c**-**Dripping down-feed riser**; the trap discharges directly into the return line.

**d**-**Vent and drip on the end** of the main for a wet return system.

**e**-**Maintaining a wet drip line** and draining through a float trap to a vacuum pump or waste.

**f**-**Thermostatic steam trap** for pressure of 0-125 psig; 1, body; 2, cap; 3, cap screws; 4, cap gasket; 5, lock washer; 6, element; 7, valve head; 8, valve seat; 9, seat gasket.

**g**-**Radiator connections** where the run-outs are on the ceiling of the floor below.

**h**-**Radiator connections** where the run-outs are in the floor construction.

**STEAM-HEATING HOOKUPS**

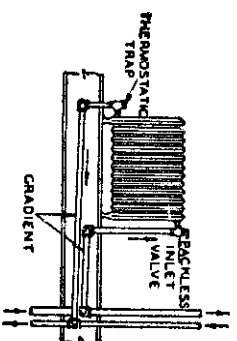
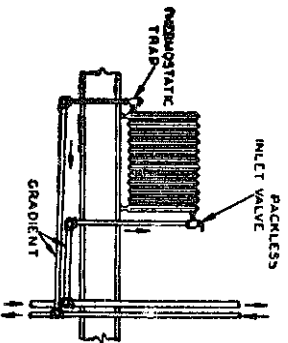
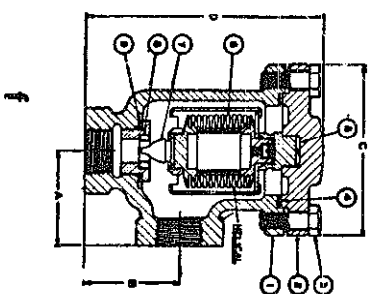
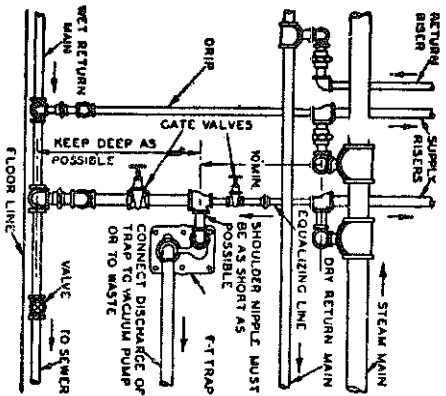
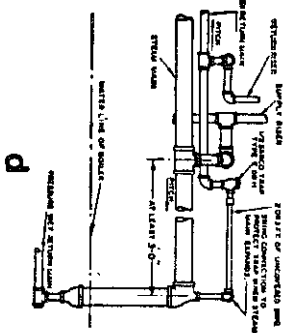
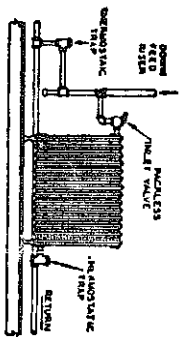
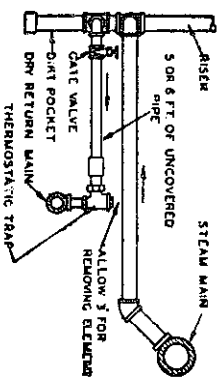
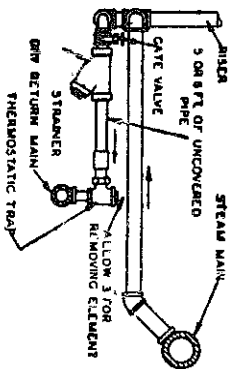



**C-Steam Heating**

**2-STEAM-HEATING HOOK-UP, DETAILS (Cont)**

**j**-Looping the **dry return** at doorways.

**k**-Connections for **basement radiators** below the dry-return main.

**:-Hartford connection** and recommended boiler connection for single low-pressure heating boiler.

**m**-Alternating **receiver lifting** the condensate from the heat exchanger.

**n**-Float **thermostatic** trap dripping base of a steam riser.

**p**-Typical **steam** run-out when the risers are not dripped.

**q**-Typical **steam** run-out when the risers are dripped.

# STEAM-HEATING HOOKUPS

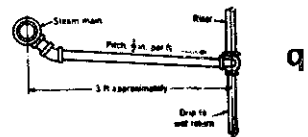
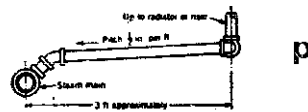
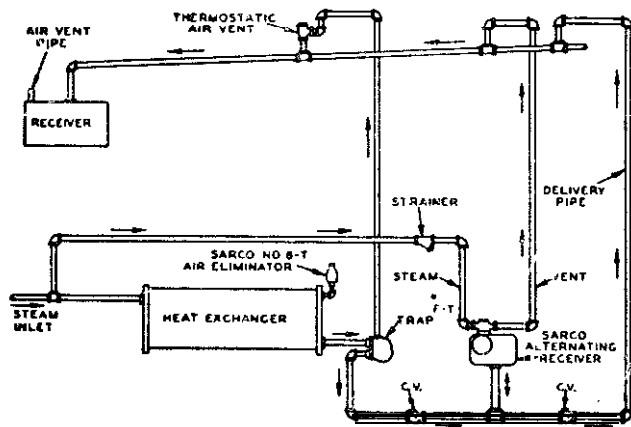
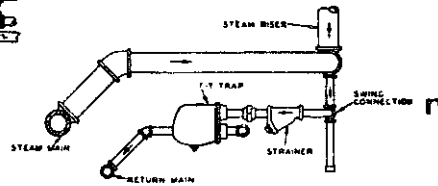
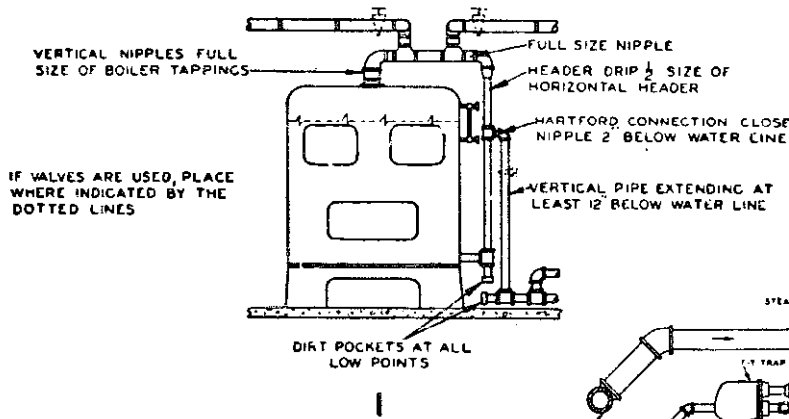
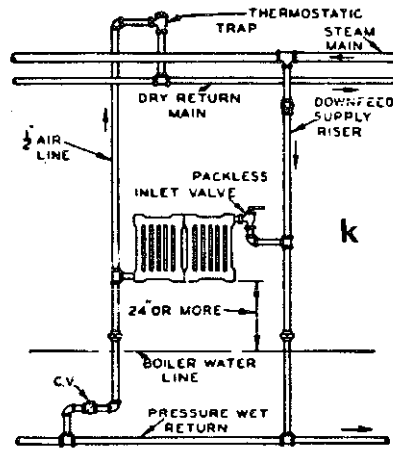
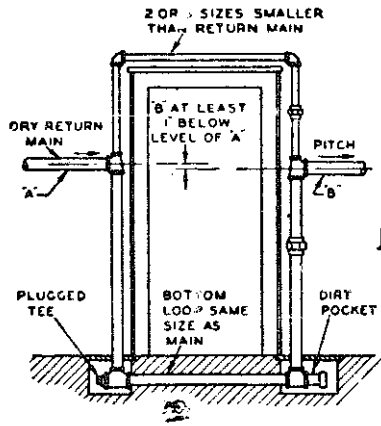

m

**C--Steam Heating**

**2--STEAM-HEATING HOOK-UP, DETAILS (Cont)**

**r-liquid-level controller**, maintaining the water level in a steam boiler.

**s-End of main dripped** through a float thermostatic trap.

**t-Blast surface** equipped with float thermostatic traps and strainers.

**u-Draining a heating-pipe coil.**

**v-Dripping floor type** low-pressure unit heater and supply line.

**w-Bucket-trap dripping** end of a steam main.

**x-Making lifts** on vacuum systems when the distance is over 5 feet.

**y- Detail of the main return lift** at the vacuum pump.

**z- Changing the size of a steam main** when the run-outs are taken from the top.

**aa-Discharge of high-pressure apparatus** into low-pressure heating mains and vacuum return mains through a low-pressure trap.

**ab-Acceptable and preferred methods** of branching from the main.

**ac-Looping** the main around a beam.

**ad-Dripping** the end of the main into a wet return.

**ae-Dripping** the main where it rises to a higher level.

**af-Reducing** the size of a main at a swing connection.

**ag - D r i p p i n g** the end of the main into a dry return; a gate valve is recommended at the inlet side of the trap.

**ah-Reducing** the size of the main.

**aj - D r i p p i n g** the heel of a riser into a dry return; a gate valve is recommended at the inlet side of the trap.

# STEAM-HEATING HOOKUPS

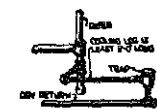
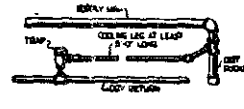
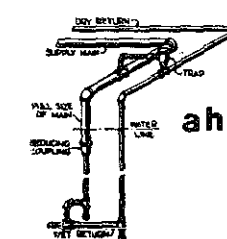
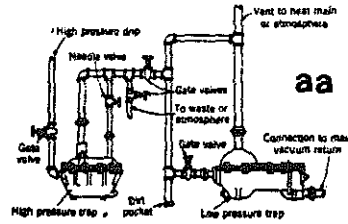
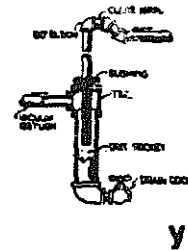
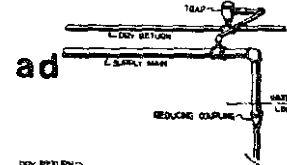
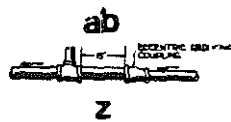
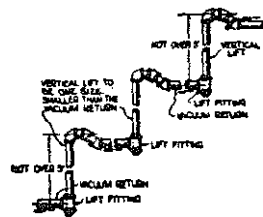
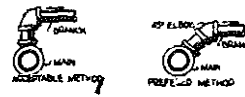
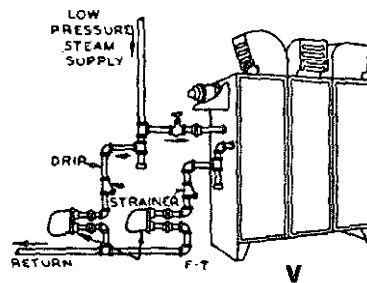
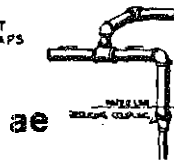
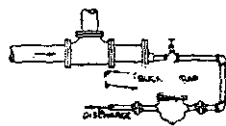
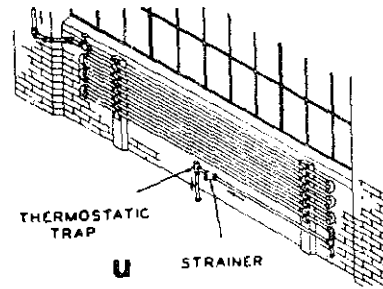
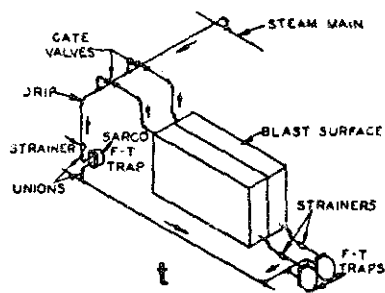
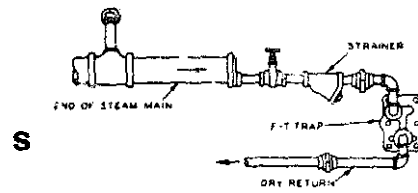
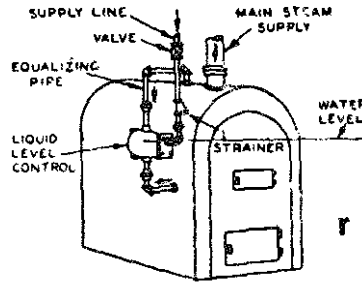

**D-Heating Systems**

**i-HOT-WATER HEATING SYSTEM**

- a-Direct-return** two-pipe hot-water system.
- b-Reversed-return** two-pipe hot-water system.
- c-Open expansion tank.**
- d-Closed expansion tank.**
- e-Gravity hot-water** system; two-pipe circulation.
- f-Forced-circulation** hot-water system; two-pipe direct return.
- g-Hot-water supply** with overhead distribution to the radiators.
- h-Down-feed hot-water** supply to the top of radiators with bottom return.
- j-Up-feed hot-water** supply to the top of radiators with bottom return.
- k-One-pipe gravity-circulation** hot-water system.
- I-One-pipe forced-circulation** hot-water system.

# HOT-WATER HEATING SYSTEM

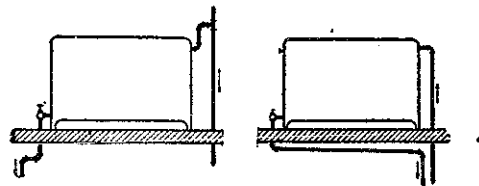
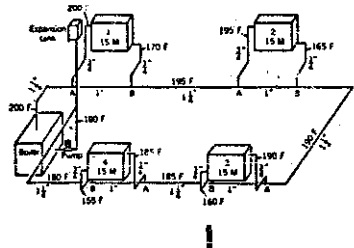
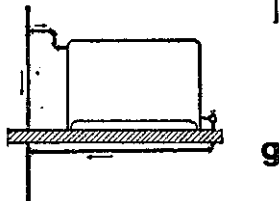
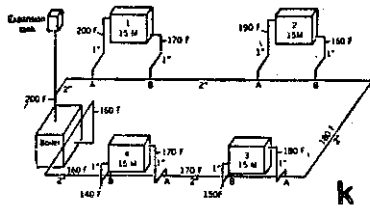
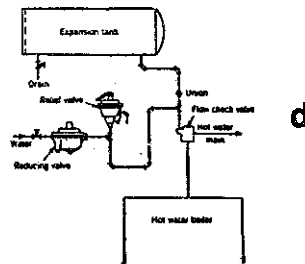
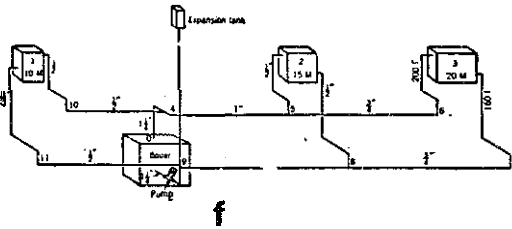
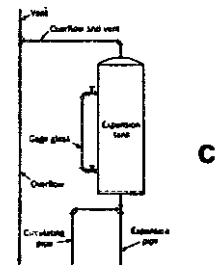
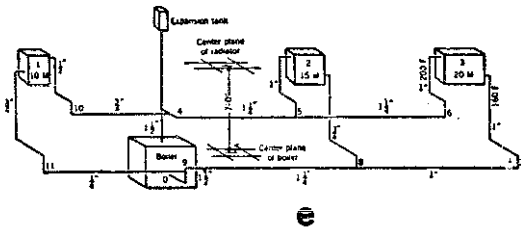
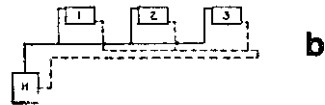
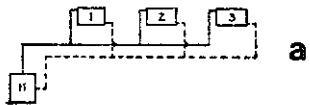

**D-Heating Systems**

**2-RADIANT HOT-WATER HEATING**

**a-Hot-water temperature control** of a radiant heating surface; Duostat; an indoor-outdoor thermostat and a high-limit thermostat control the steam supply to the hot-water heater.

**b-Controlling a three-way mixing** valve on a hot-water supply to pipe coils in a radiant heating surface with room thermostat and high-limit thermostat controls; automatic firing unit on a hot-water boiler.

**c-Zone control** of radiant heating surfaces; an indoor-outdoor thermostat and a high-limit thermostat control a diaphragm valve in the steam supply to the hot-water heater; room thermostats control the diaphragm valves in the water supply to the individual room coils.

# RADIANT HOT-WATER HEATING

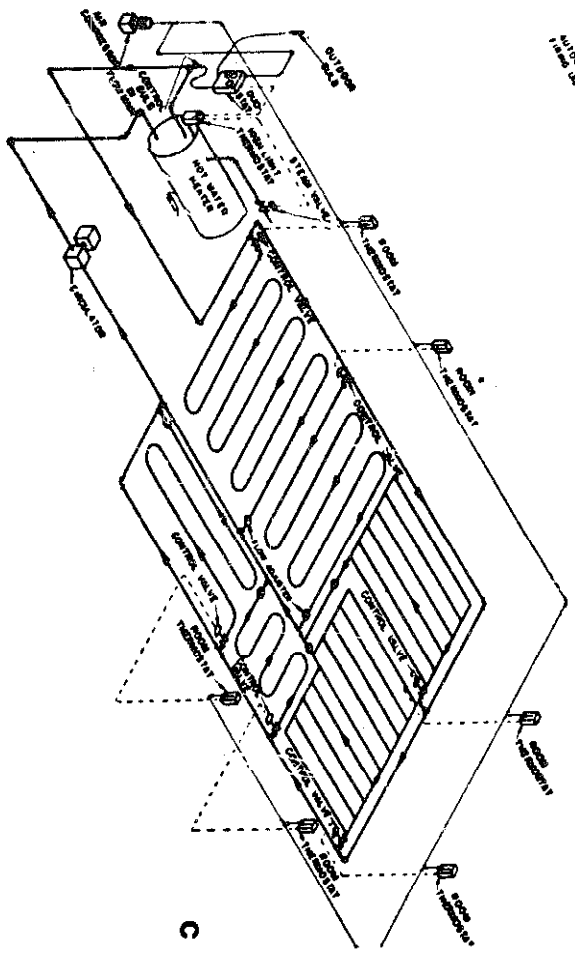
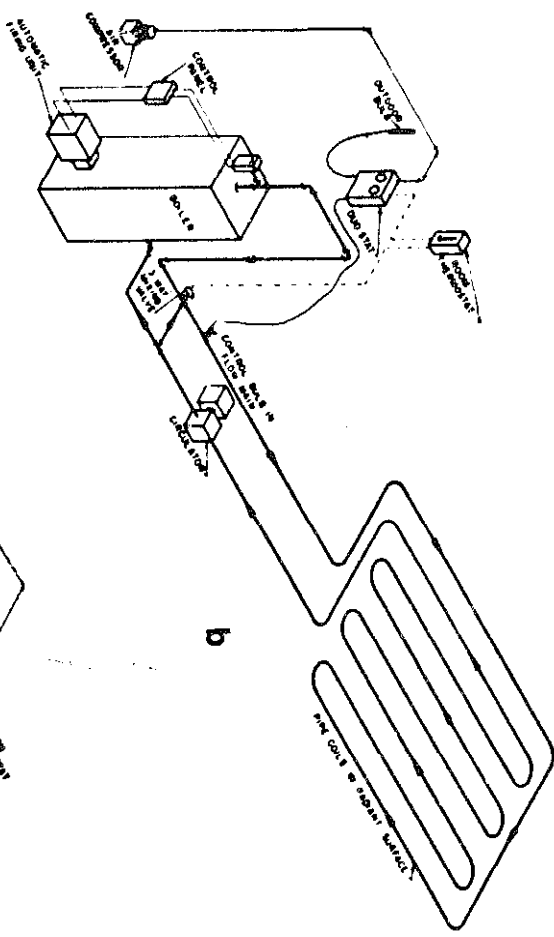
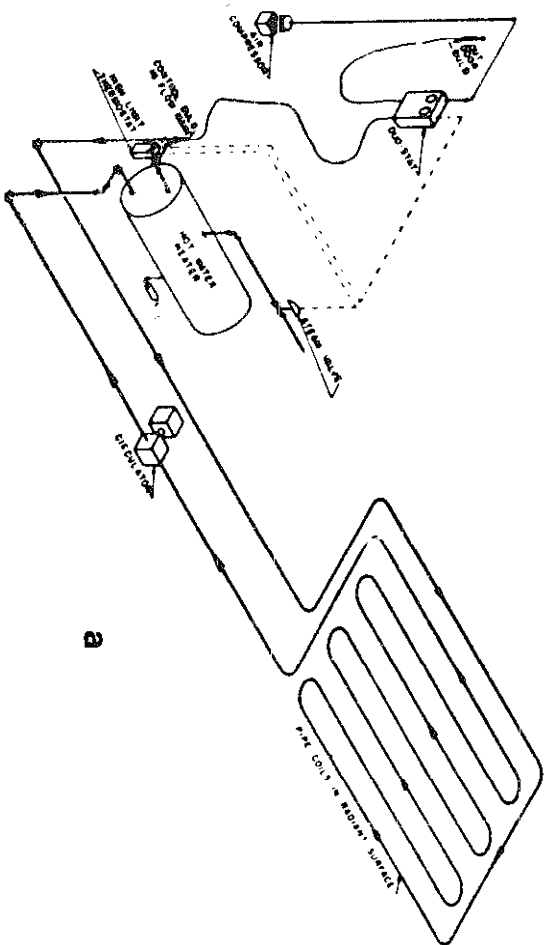



## D-Heating Systems

### 3-RADIANT HEATING

**a-Radiant heating coil** laid on a lath which is attached to the joists in the usual manner; rock wool or any other loose insulating material is then laid over the pipe between joists.

**b-Heating coil hung** below the joists with the metal-mesh lathing wired to the pipe; plaster is then applied to the lath and covers the pipe as indicated.

**c-Radiant heating coil** embedded in a concrete floor panel over reinforcing supported by a steel beam or joist.

**d-Heating coil laid** on top of joists with wood flooring supported by sleepers laid over the coil; some type of insulating board is used between the joists as shown; this board is supported by stops nailed to the joists.

**e-Radiant heating coil** embedded in concrete which has been poured on a bed of packed gravel.

**f-Heating coil in** packed gravel over which the concrete floor has been poured.

**g-Heating coil laid** on top of concrete and wood flooring supported by sleepers laid over the coil.

**h-Sand is leveled** on a bed of packed gravel: radiant heating coil laid on the sand and the concrete floor poured.

**j-Square coil;** hot lines are on the exterior of the room; it is cooler in the center.

**k-Grid coil;** minimum bending is required.

**l-Continuous coil in parallel** with low friction-head loss.

**m-Continuous coil;** minimum welding is required.

# RADIANT HEATING

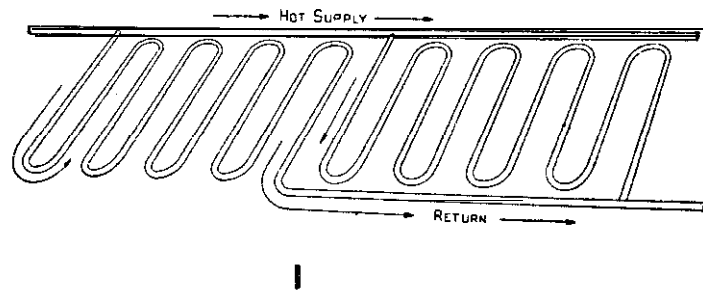
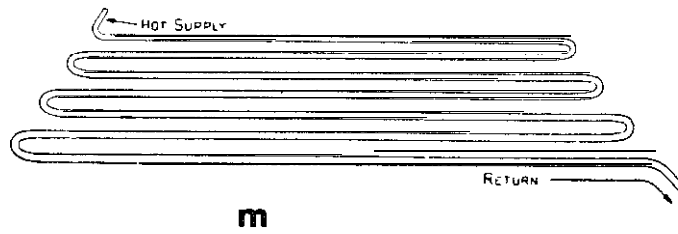
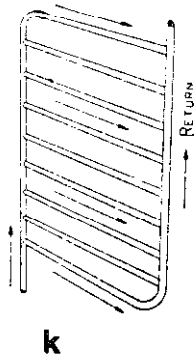
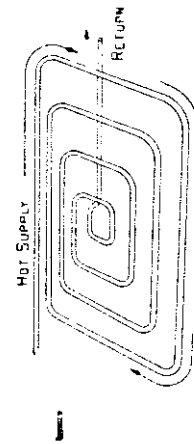
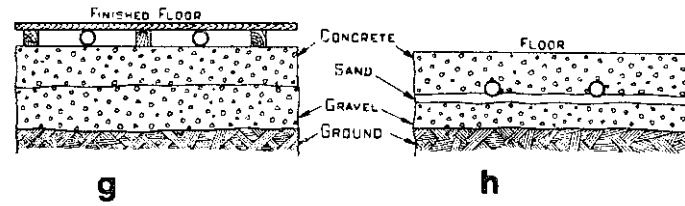
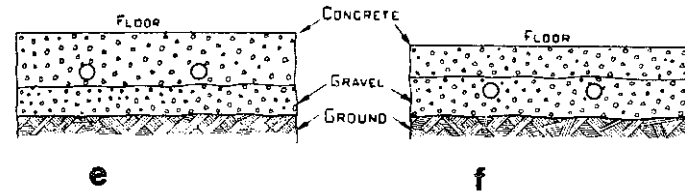
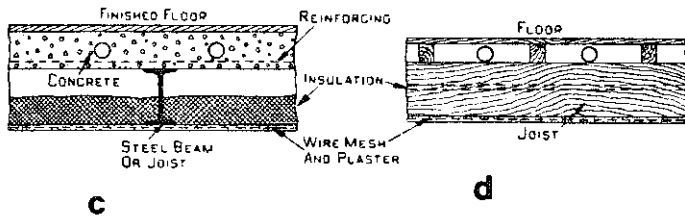
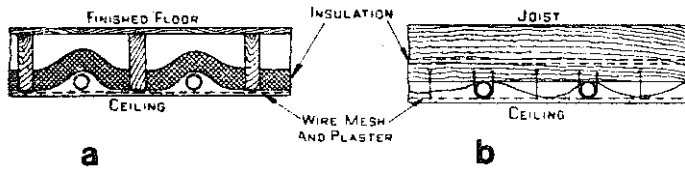

## D—Heating Systems

### 4—WARM-AIR HEATING SYSTEM

**a-Gravity warm-air heating system;** when an air-circulating fan is inserted in the duct supply system it is called a forced-air system; **A**, the house chimney, no bends nor offsets; **B**, top of chimney at least 2 feet above the ridge of the roof; **C**, flue lining, fireclay; **D**, all joints air tight; **E**, at least 8 inches brick; **F**, no other connection beside that to the furnace; **G**, clean-out frame and door, air tight; **H**, smoke pipe, end flush with inner surface of flue; **I**, draft door; **J**, flue thimble; **K**, casing body; **L**, casing hood or bonnet, the top of all leader collars on the same level; **M**, round leader, pitch 1 inch per foot; **N**, sleeve with air space around the leader where passing through the wall; **O**, dampers in all leaders; **P**, transition fittings; **Q**, rectangular wall stack; **R**, baseboard register; **S**, pipes distributed equally around the bonnet; **T**, floor register, **U**, return air face; **V**, panning under joist; **W**, transition collar; **X**, round return pipe; **Y**, transition shoe; **Z**, the top of the shoe at the casing not above grate level.

# WARM-AIR HEATING SYSTEM

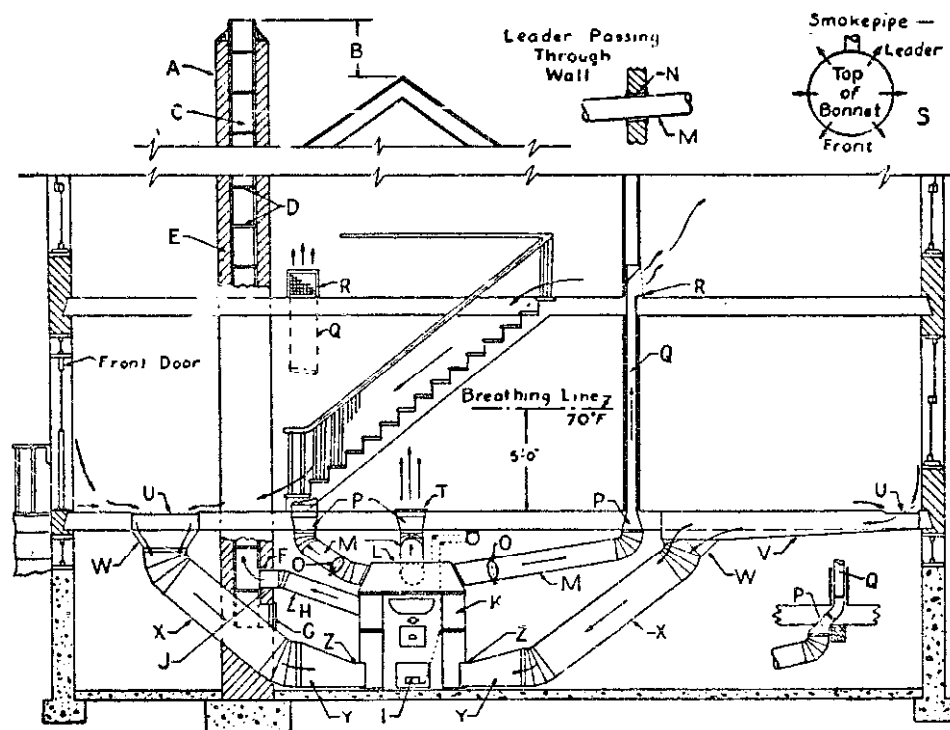

a

**D-Heating Systems**

**4-WARM AIR HEATING SYSTEM (Cont.)**

**a-Air flow and air mix of a ceiling grille (Anemostat Products Division)**

**b-Proper fan discharge connection.**

**c-Poor fan discharge connection.**

**d,e,f,g-Filter, washer, cooler, and heater connections.**

**g-Easement around obstructions.**

**h,j-Branch take-offs.**

**k-Sheet metal sections.**

WARM-AIR HEATING SYSTEM

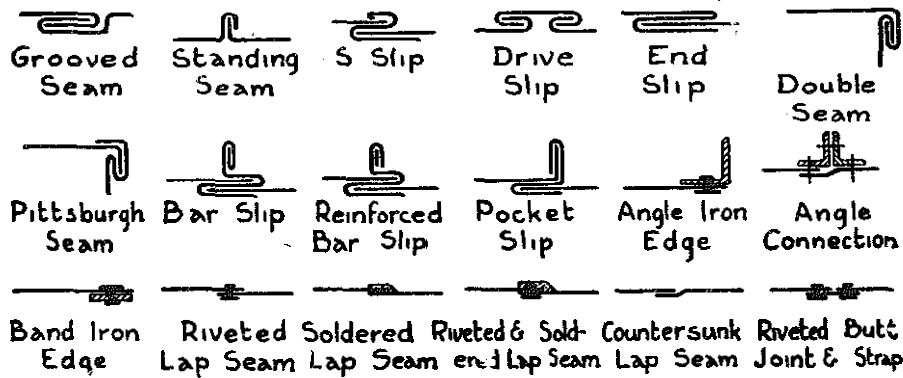
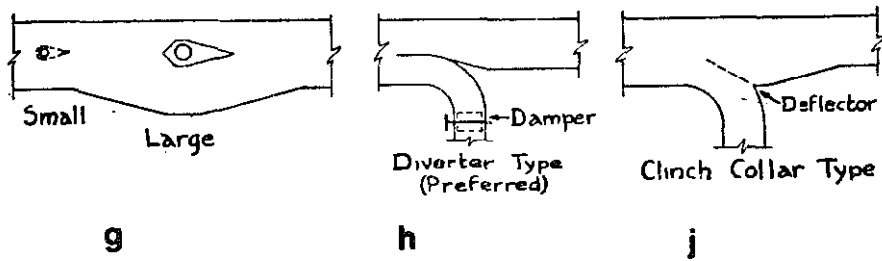
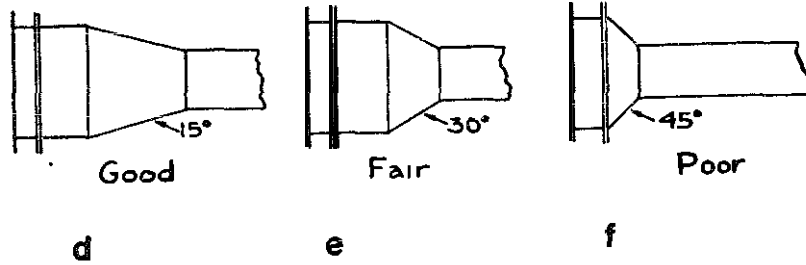
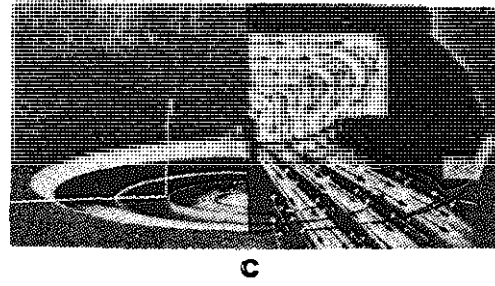
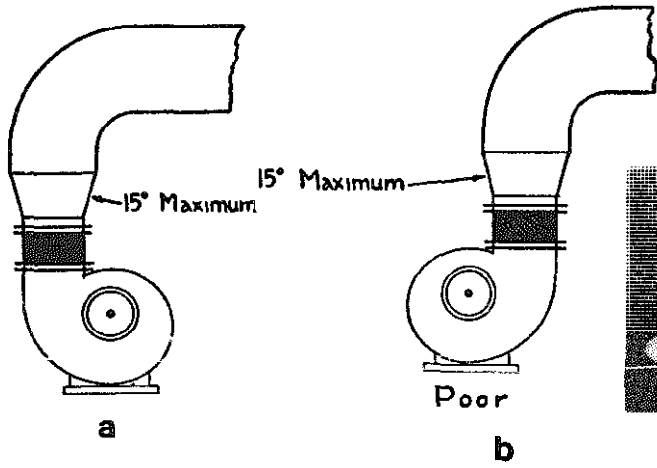

k

**D-Heating Systems**

**5-HEAT-PUMP SYSTEMS**

**a-Air-to-air heat-pump** system hooked up for cooling effect; valves on dotted lines closed, thus permitting operation as a refrigeration system in which heat at a temperature level too high for use as a cooling effect is extracted in the evaporator (inside surface), pumped by the refrigeration mechanism to a higher temperature and rejected by condenser (outside surface) to a condensing medium usually water, but, in this case, the outside air. The heat-pump system is frequently referred to incorrectly as the reverse cycle system.

**b-Air-to-air heat-pump** system hooked up for heating effect; valves on dot-dash lines closed thus permitting operation as a heat-pump system in which heat at a temperature level too low for heating purposes is absorbed in the evaporator (outside surface), pumped by the refrigeration mechanism to a higher temperature and rejected by the condenser (inside surface) to a condensing medium usually water, but, in this case, the desired warm air.

**c-Water-to-water heat-pump** system hooked up for cooling effect in which the cooled air desired is passed over pipe coils through which cooled water is recirculated. The condenser water (c.w.) from outside source is rejected to the drain.

**d-Water-to-water heat-pump** system hooked up for heating effect in which warm air desired is passed over pipe coils through which warm condenser water is recirculated. The water from the heat source passes through the water cooler and is rejected to the drain.

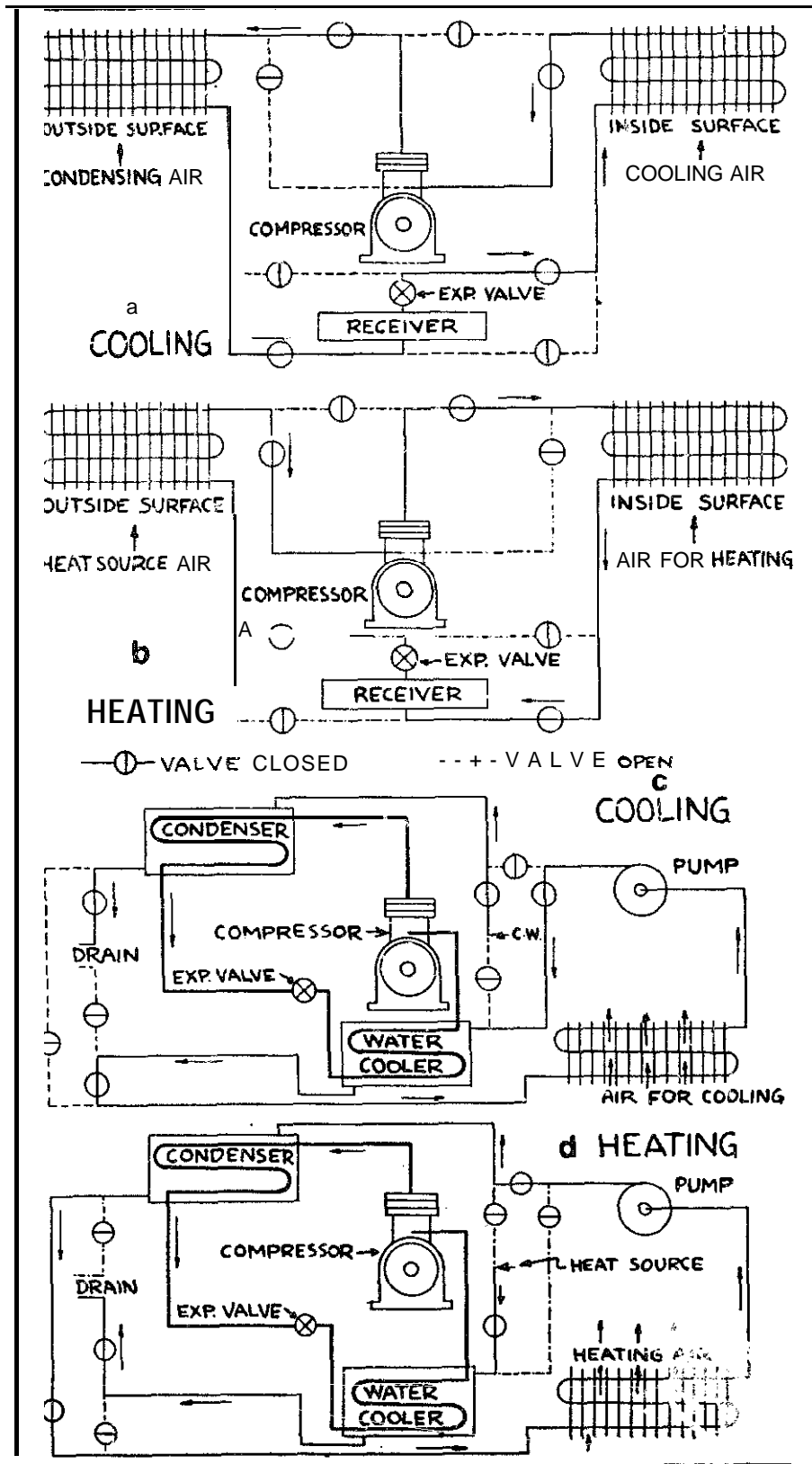



## PART IX – TRANSDUCERS

Transducers provide a usable output in response to a specific measurand, where the measurand is the physical quantity, condition or property to be measured. Reactive types are usually used with a reactive reference element (same type) and two resistors, arranged as four legs of a bridge circuit. Input a-c, output mostly d-c proportional to unbalance in amplitude and phase.

### A—Displacement Types

1—INDUCTIVE OR CAPACITIVE TYPE - converts displacement into a change of self-inductance or capacitance

**a-Coupled type.** Self-inductance of the coil (bobbin) is changed by the motion of the magnetically permeable core.

**b-Noncontacting type.** As object is brought closer to coil, self-inductance of coil changes.

**c-Noncontacting inductive type.** Used in bridge type circuit with separate electronic package. (Kaman Nuclear).

**d-Moving dielectric type (Capacitive).** Concentric cylinders form capacitor. Motion of inserted dielectric sleeve changes capacitance.

**e-Moving rotor type (noncontacting).** The transducer forms one plate of the capacitor, moving measurand the other. Change in displacement varies capacitance of transducer.

**f-Coupled moving rotor type.** Two concentric cylindrical electrodes separated by a dielectric. Displacement of either cylinder changes capacitance of the transducer.

**g-Moving rotor, split stator type.** Sensing shaft is connected to ganged capacitor plates, each of the capacitor plates moving between two stator plates.

# INDUCTIVE OR CAPACITIVE

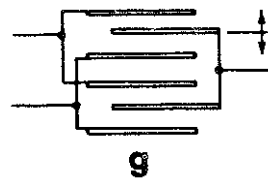
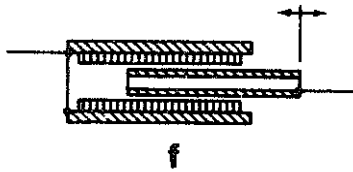
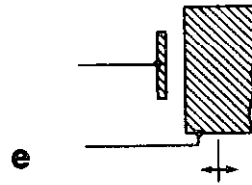
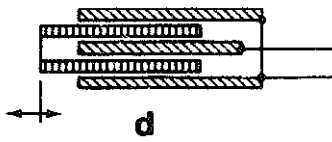
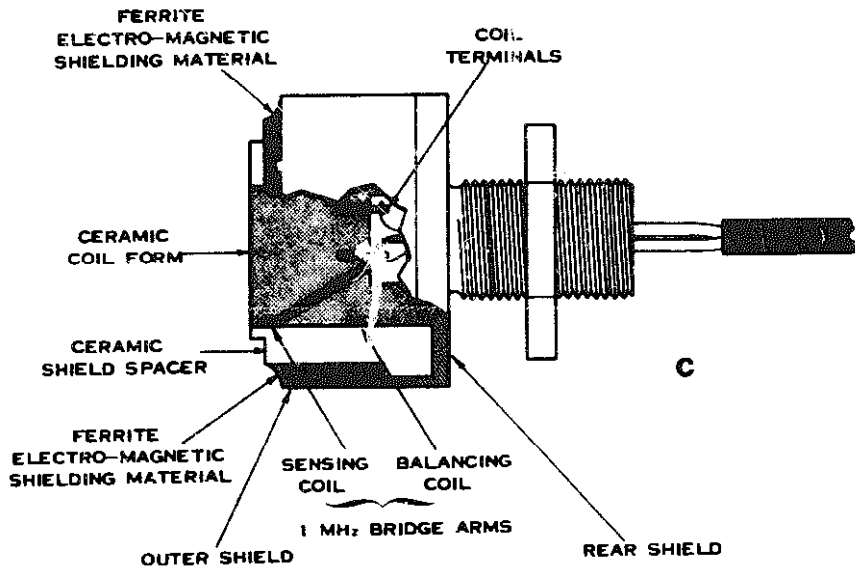
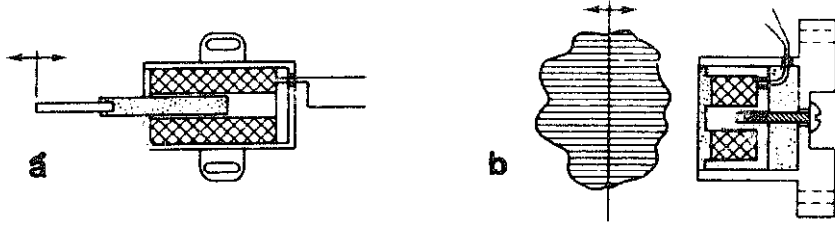

**A-Displacement Types**

**2-VARIABLE RESISTANCE TYPE** - devices having a sliding contact (wiper) moving across a resistance element. The wiper is linked mechanically to a sensing shaft.

**a-Basic linear type**. Shaft position determines position of wiper and, therefore voltage on wiper.

**b-Basic linear type**. Same as "a" above, except voltage is taken from wiper bus.

**c-Angular potentiometer**, Angular position of wiper determines voltage with respect to terminals. One turn, multiturn (3,5,10 turns) or continuous rotation available.

**d-Angular (sector) potentiometer (with taps)**. Sector potentiometer with one tap.

**e-Potentiometric transducer**. For large linear displacement. (General Dynamics Corp., Convair Division)

**f-Detail**. Wiper type, hooked.

**g-Detail**. Wiper type, arm.

**VARIABLE RESISTANCE**

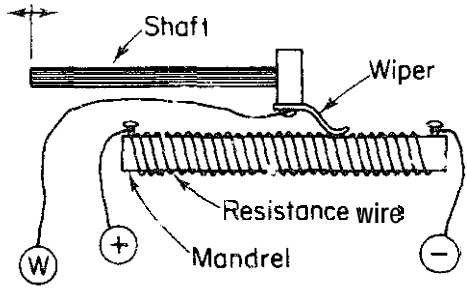

**a**

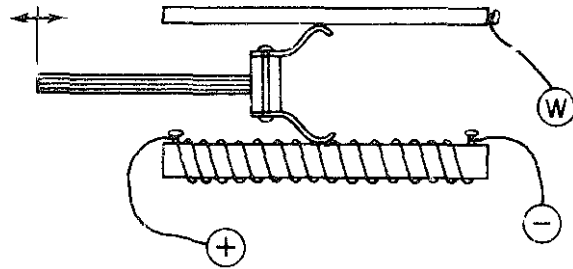

**b**

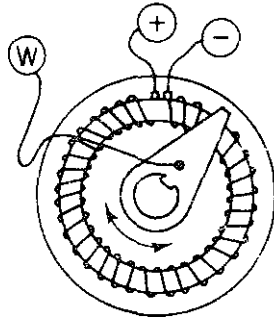

**c**

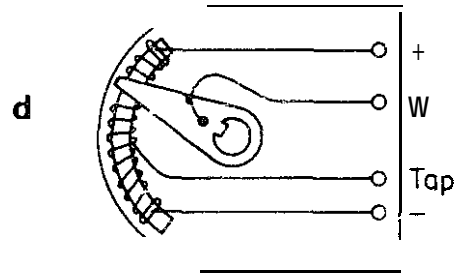

**d**

360-degree rotary potentiometer

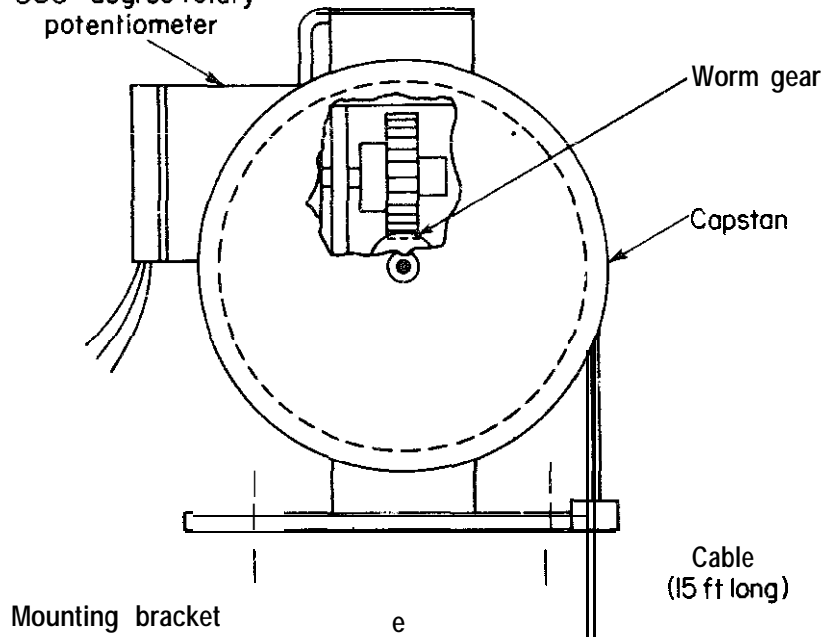

**e**



**f**

**g**

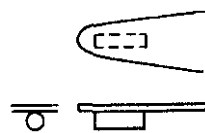

**A-Displacement Types**

**3-RELUCTIVE TYPES.** These convert displacement into an a-c voltage change. Through a variation of the reluctance path between coils.

**a-Differential transformer, type (Linear).** A high permeability core slides freely in a bobbin. If core moves, output and phases of secondary change.

**b-Differential transformer, angular type.** Works similar to linear transducer "a". It usually has an E-core type of arrangement.

**c-Linear inductance bridge.** Linear motion of core increases inductance of one coil, while it decreases inductance of the other coil. Two coils form one half of a four arm a-c bridge.

**d-Angular type inductance bridge.** Operation identical to "c" except that motion of core is angular.

**e-Induction potentiometer.** The rotor has a single primary winding, stator single winding or two windings in series. Provides linear output for angular rotation over limited range.

**f-Circuit application.** Simple modulator circuit delivers d-c from differential transformer.

**g-Physical configuration of differential transformer.** See "a".

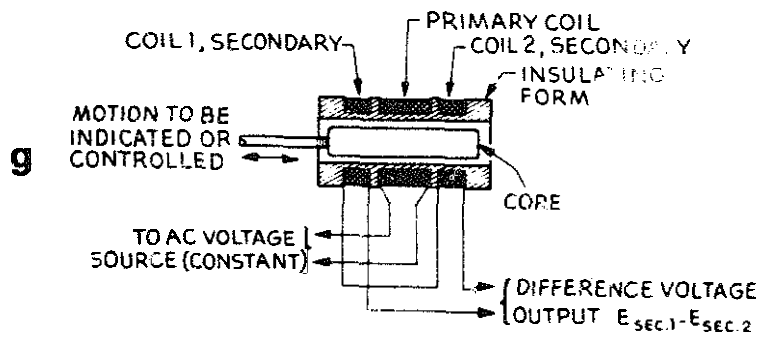
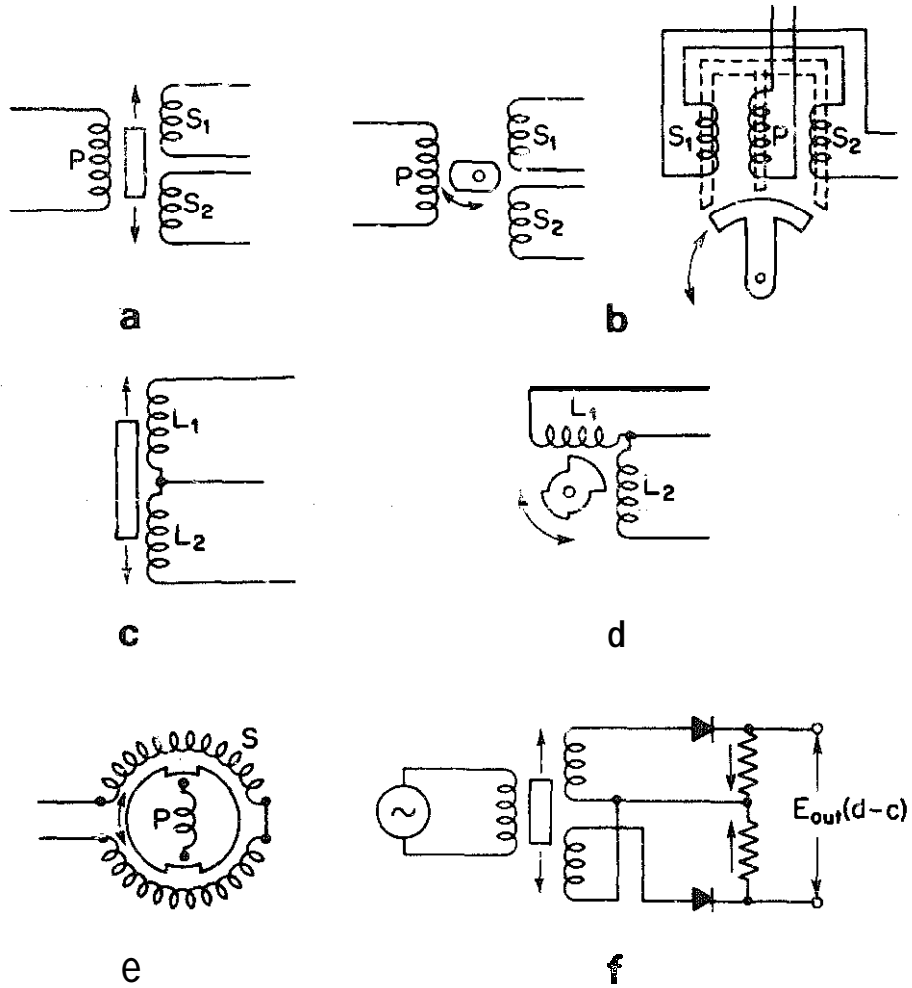

**A-Displacement Types**

**4-MISCELLANEOUS**

**a-Photoelectric shaft-angle encoder.** Multi-track transducer having a light source and light sensor for each track. Disk is coded so that shaft position is uniquely determined with respect to zero position of shaft by the numerical value of the activated light sensor, determined by its position.

**b-Binary coded disc with brushes.** Discs are encoded in the binary system. Shaded sectors represent "1", blank sectors "0". The disc indicates the arabic number 11 ( $1+2+0+8=11$ ). (Litton Industries).

**c-Strain gage angular type.** Deflection of element results in resistance change by strain gages mounted to it. The gages are connected as a bridge circuit. (BLH Electronics).

**d-Auto transformer type.** Coil is tapped in many places. Position of sliding contact determines output voltages, which is a fixed percentage of excitation voltage.



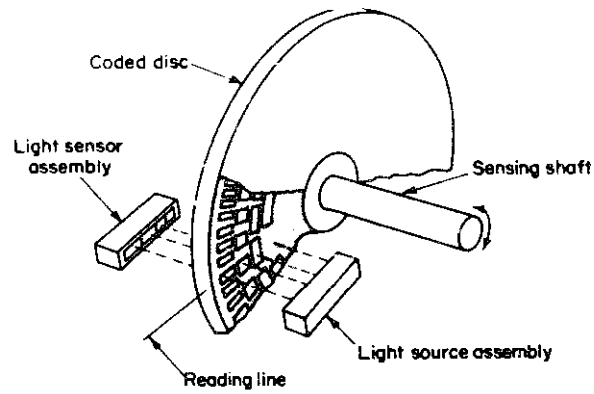

a

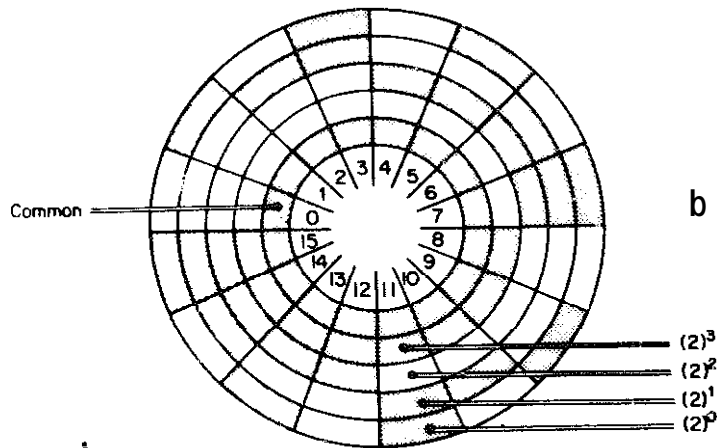

b

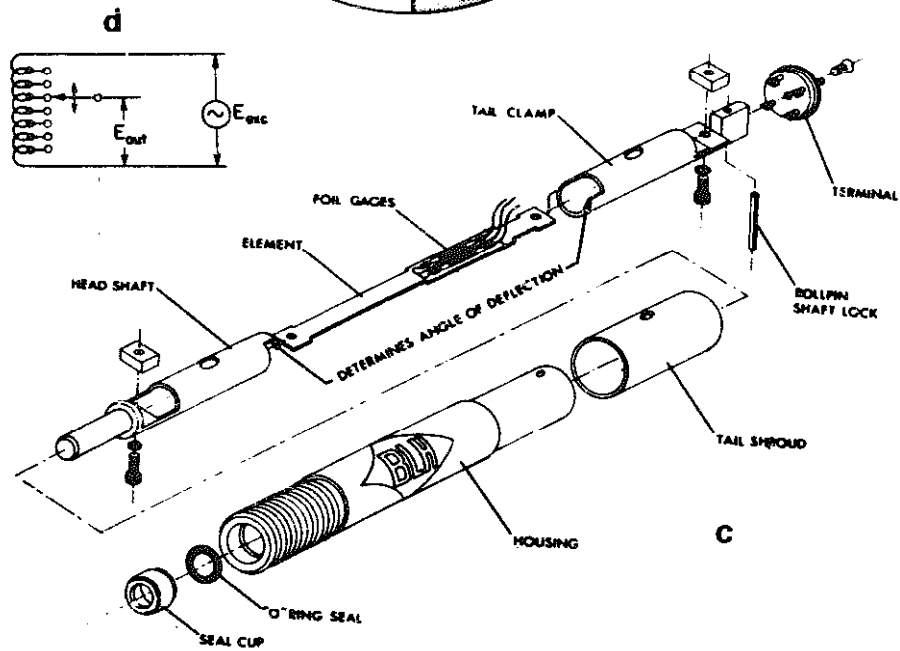

d

c

### B-Pressure Transducers

Pressure transducers sense the pressure through a mechanical thin-walled member like a diaphragm shell or tube, etc., which can be deflected. All transducers measure differential pressure, but read differential, absolute or gage pressure, depending on their construction. For absolute pressure, the reference pressure side is usually evacuated. For gage pressure, sensing-reference side open to atmospheric pressure. For differential pressure—pressures measured relative to each other.

#### 1—SENSING ELEMENTS

**a—Flat diaphragm type.** Supported at the edges. Deflection is a measure of the pressure.

**b-Corrugated diaphragm.** Concentric corrugations increase stiffness and exposed area. Larger deflections are possible.

**c-Aneroid.** Two corrugated metal diaphragms, usually hermetically sealed. Deflections doubled in this arrangement.

**d-Bellows.** Thin walled tubing formed into a number of convolutions with one end sealed and a fitting on the other end. Used for large strokes and low pressures.

**e-C-shaped Bourdon tube.** This C-shaped tube is sealed at the tip with pressure applied to inside of tube. Tube straightens by tip deflection.

**f-spiral type Bourdon.** Pressure applied to inside of tube. Tip travel magnified.

**g-Helical Bourdon tube.** Same as C-shaped type “e” but larger tip travel.

**h-Twisted Bourdon tube.** An ovaly flattened tube twisted along its full length with applied internal pressure, resulting in rotary motion of the tip.

**j-Straight tube.** One end of tube is sealed. Pressure differential causes small expansion or contraction of tube diameter.

# SENSING ELEMENTS

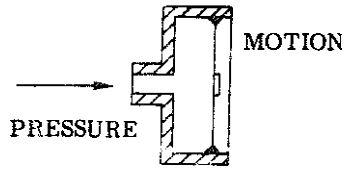

a

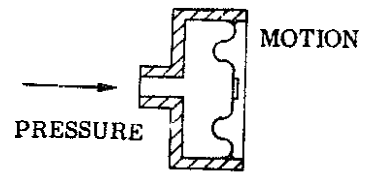

b

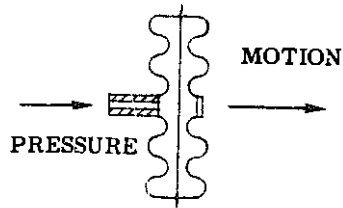

c

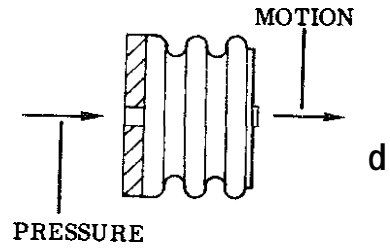

d

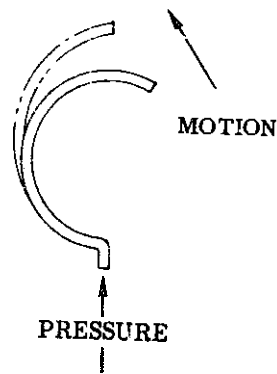

e

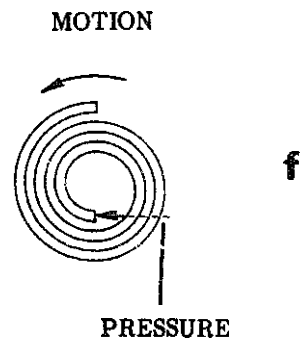

f

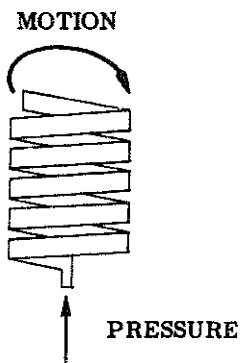

g

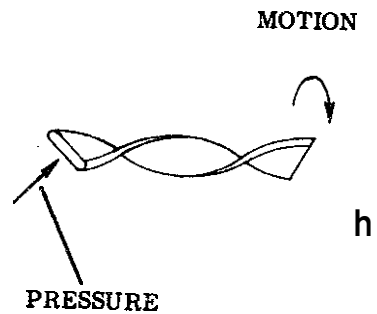

h

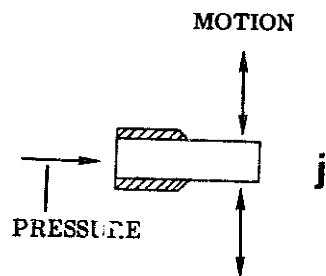

j

**B-Pressure Transducers**

**2-CAPACITIVE, INDUCTIVE AND PIEZOELECTRIC**

**a-Single stator capacitive type.** Diaphragm and stator form a capacitor. Pressure on diaphragm changes capacitance (through motion). Capacitor is part of LC tank circuit of an oscillator, and changes are evaluated by the varying output. (Omega Dynamics Corp.)

**b-Dual stator capacitive type.** Used mostly in a bridge circuit. Diaphragm moves under pressure, decreasing capacitance on pressure side, while increasing capacitance on reference side. (Rosemount Engineering Co.)

**c-Differential capacitive type.** Uses a capacitor formed by a clamped diaphragm and two metallized glass discs. Here, changes in capacitance modify frequency of L-C oscillator circuit. (Trans-Sonics Inc.)

**d-Inductive absolute pressure transducer.** Motion of diaphragm to and from core change the inductance of the coil.

**e-Piezoelectric dynamic pressure transducers.** The crystal sensing element produces a charge  $E$  directly proportional to the applied force. The model shown is acceleration compensated. (Note: not used for static pressures). (Kistler Instrument Corp.)

**f-Vibration compensated piezoelectric type.** Similar to "e", compensated for vibration. (Gulton Industries).

# CAPACITIVE, INDUCTIVE & PIEZOELECTRIC

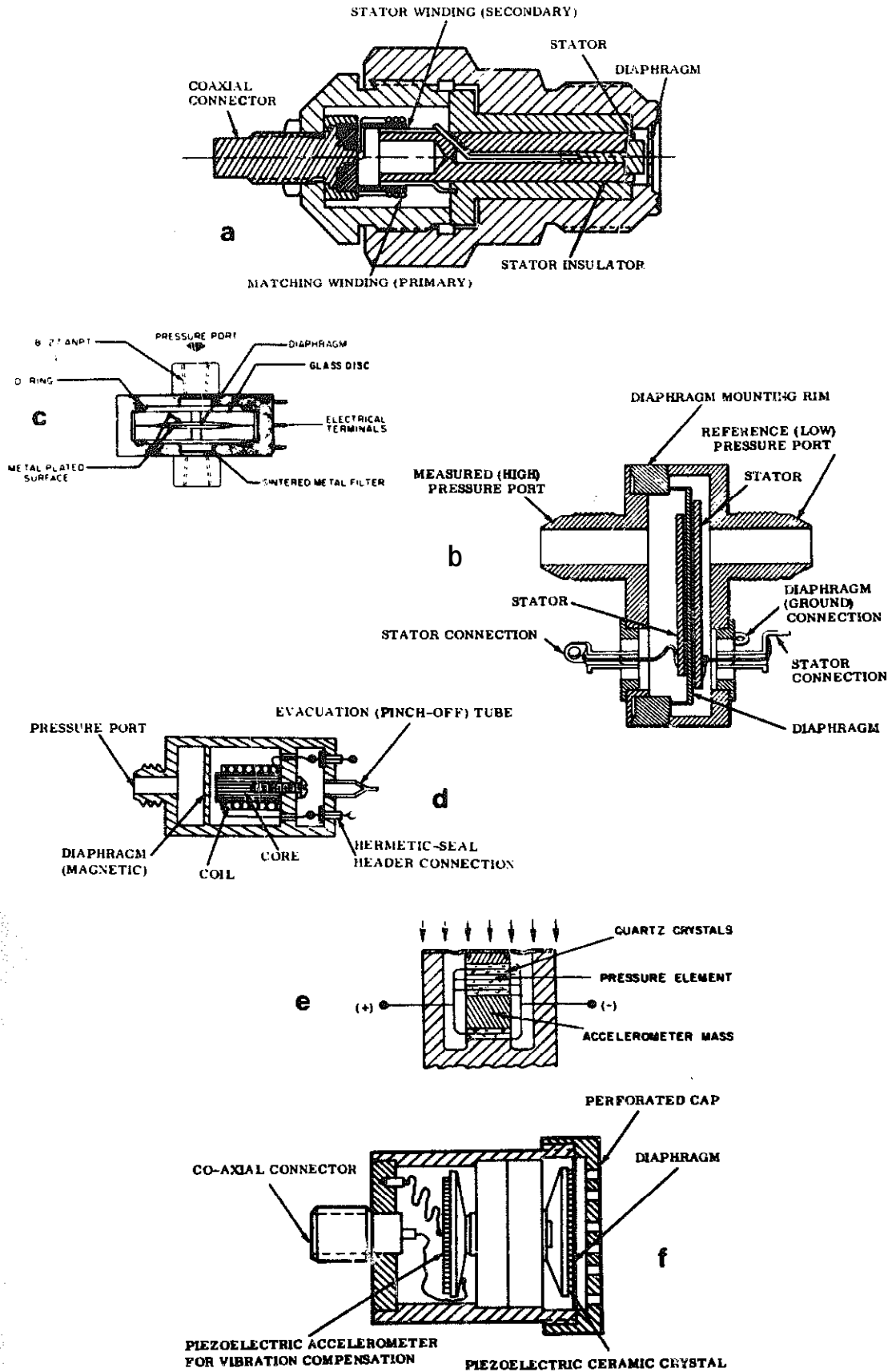

### B-Pressure Transducers

#### 3-VARIABLE RELUCTANCE AND RESISTANCE TYPES

**a-Variable reluctance type.** Diaphragm is magnetically permeable and placed between two coils wound on ferric cores. Diaphragm motion produces changes in flux pass of both coils.

**b-Reluctive pressure type.** Twisted Bourdon tube has armature on end. The two coils are wound on an "E"-core. Motion of armature produces same effect as "a". (Wiancko Eng. Co.)

**c-Rzluctive pressure type.** C-shaped Bourdon tube under pressure moves core of differential transformer.

**d-Potentiometric type.** Motion of Bourdon tube actuates wiper arm of potentiometer. Unit is in evacuated sealed case. (Trans-Sonics Inc.)

**e-Potentiometric type.** Using capsule (aneroid) as force sensor.

**f-strain-gage pressure.** The primary sensing element is a bending beam with four gages. Bending is concentrated at 1-2 and 3-4. Pressure deflects steel diaphragm which in turn deflects beam with attached gages. Bridge type connection required. (Data Sensors, Inc.)

# VARIABLE RELUCTANCE & RESISTANCE

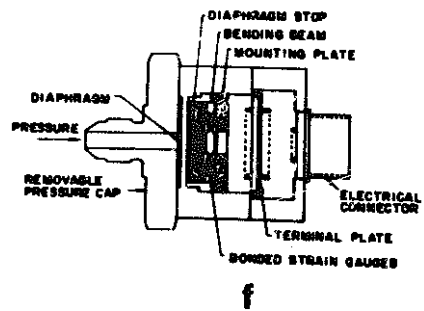
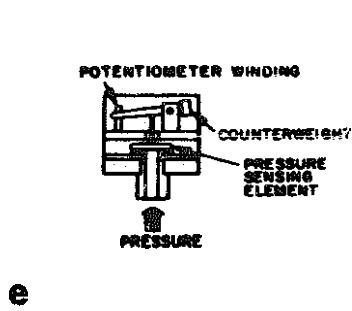
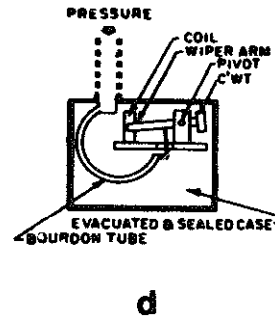
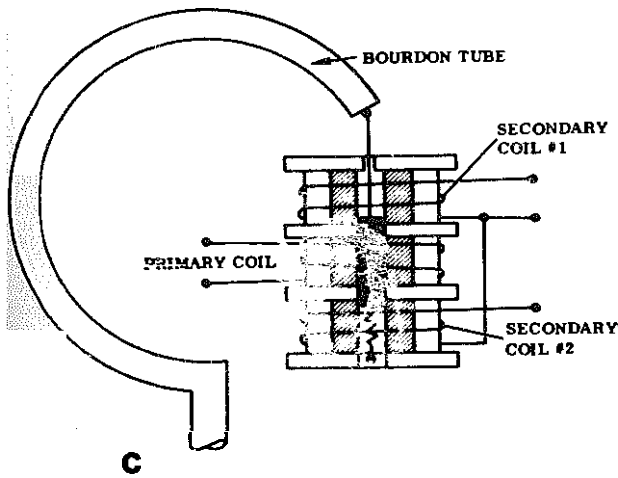
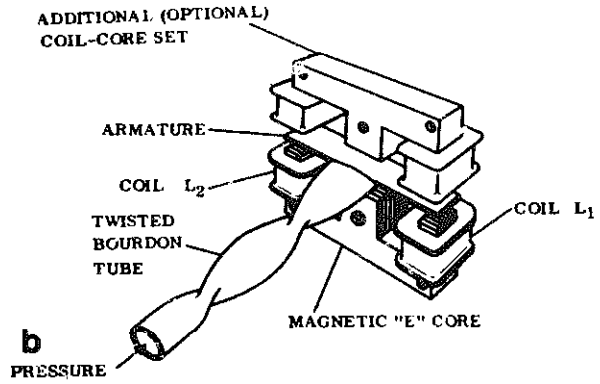
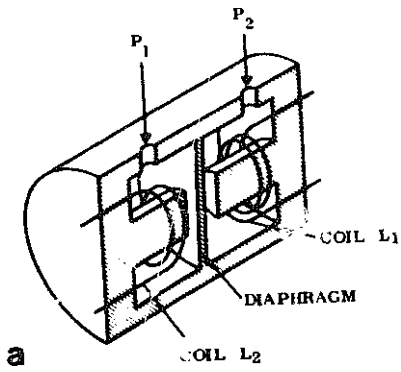

**C-Temperature**

**1-THERMOCOUPLES** - These are made from two different material combinations like iron-constantan, copper-constantan pairs. When heated, a voltage is produced at the junction.

**a-Wire thermocouple.** Reference junction is maintained at known reference temperature. If a different temperature is sensed at "t", a voltage is produced, which is proportional to the temperature difference.

**b-Foil thermocouple.** Used to measure surface temperature. Foils are symmetrical with butt-type junction. (RDF Corp.)

**c-Same as "b".** (RDF Corp.)

**d-Immersion probe.** This thermoprobe has the sensing junction exposed. (Fenwal Electronics.)

**e-Resistive temperature transducers.** Shown is the probe end of a transducer with enclosed wire instruments. Its principle depends on resistance change due to heat. (Thomas A. Edison Industries.)

**f-Surface temperature transducer.** Coiled wire sensing elements are bonded to inside of case. Mounting methods vary. (Rosemount Engineering Co.).

**g-Cartridge for mounting thermocouple.** Straight type. For insertion into die plates of molding presses etc.

**h-Cartridge holding thermocouple.** Used for insertion into hot gases or liquids; pressures up to 3000 psi permissible.

**j-Cartridge for holding thermocouple.** Bayonet fitting for quick disconnect.



# THERMOCOUPLES

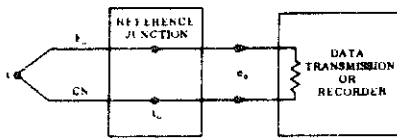

a

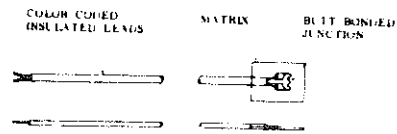

b

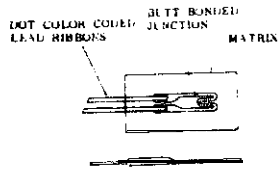

c

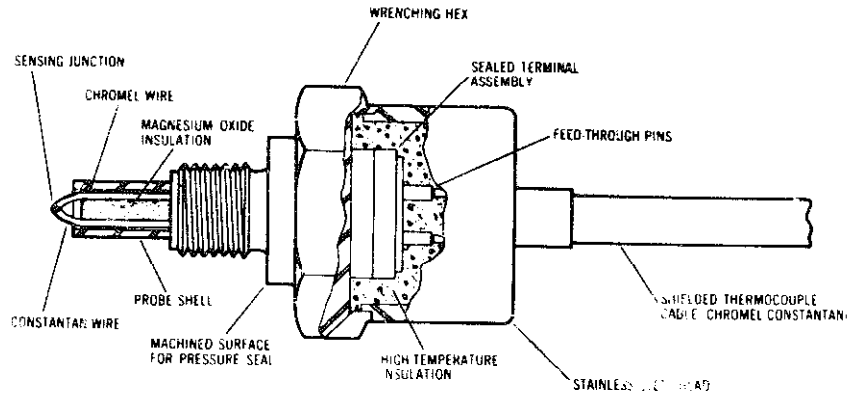

d

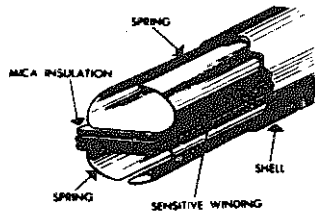

e

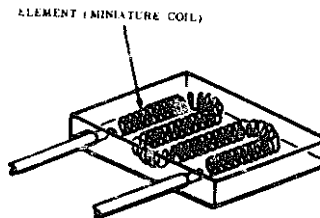

f

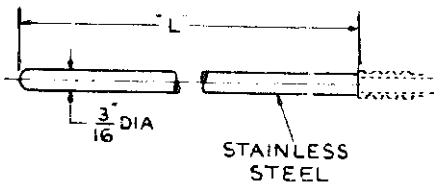

g

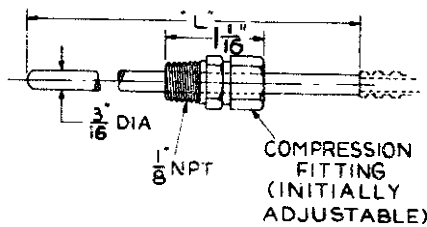

h

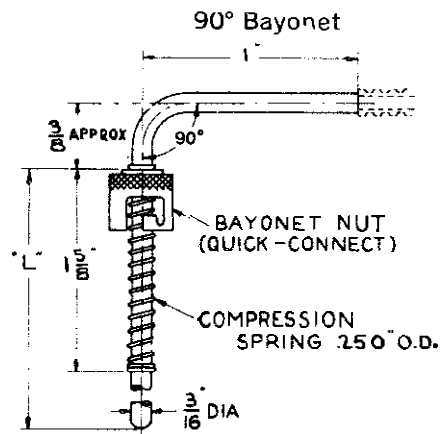

i

**C-Temperature**

**2-THERMISTORS.** These ceramic semiconductors are resistors with negative temperature coefficients; an increase in temperature lowers the resistance and vice versa. Available in many shapes they are used to measure or control temperature, for voltage regulation, temperature compensation, time delays, sequencing etc.

**a-Bead thermistor,** on two parallel wires.

**b-Bead thermistor,** on two parallel offset wires.

**c-Rod type.** Axial leads.

**d-Rod type.** Adjacent radial leads.

**e-Bead in glass probe.**

**f-Bead in glass bulb.**

**g-Wafer type.** With lead mounted on plate.

**b-Washer type thermistor assembly.**

**j-Disc thermistor.** Assembled in probe for gases or liquids.

**k-Disc type.** With adjacent radial leads.

**l-Disc-coated type.**

**m-washer type.** With 9/32" diameter hole.

**n-Disc thermistor.** With axial leads.

**p-Typical Time Delay Circuit.** Using thermistor.

**q-Most used thermistor symbol.**

# THERMISTORS

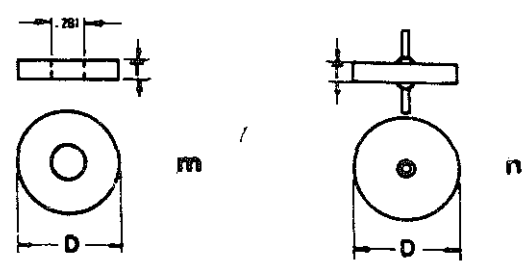
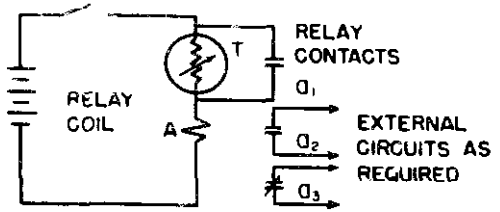
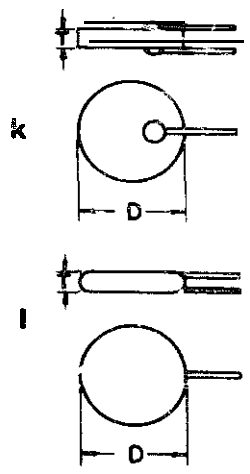
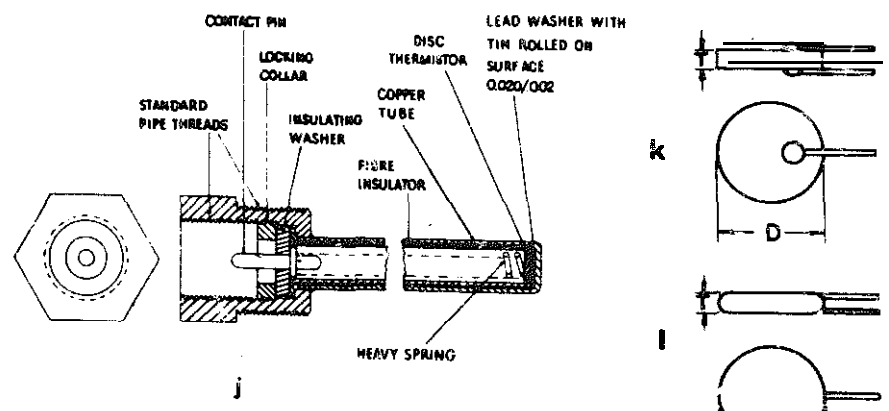
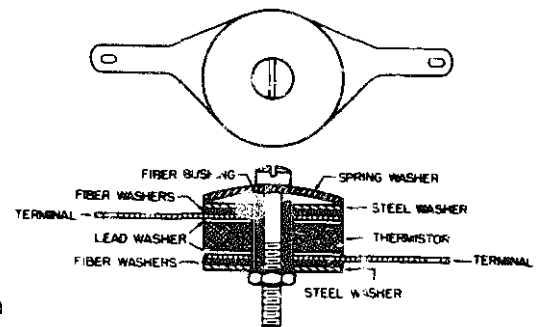
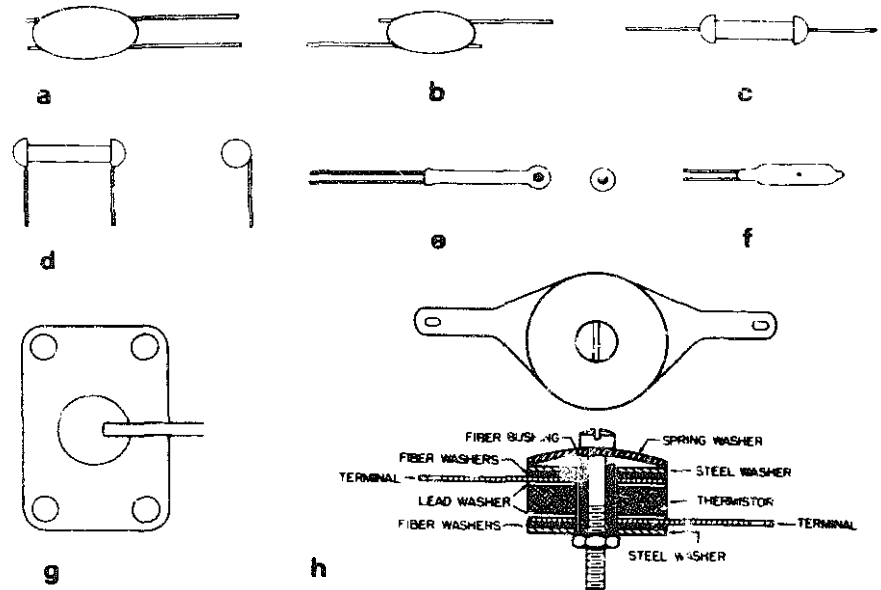

### C—Temperature

3—THERMOSTATIC TYPES, (bimetallic) consist of two metals of different coefficients of expansion.

a—**Bimetallic strip.** Due to different expansions of the metals the strip will bend. Direction depends on temperature differential.

b—**Rod and tube type.** Relative motion between rod and tube due to different expansion of metals. It is used for control.

c—**Spiral bimetallic thermostat.**

d—**Straight strip bimetallic thermostat.**

e—Application of “b” for thermostat. Expansion closes inlet.

f—**Curved strip bimetallic thermostat.**

g—**Surface thermometer.** Bimetallic coil, on hot surface, moves pointer. Two ancillary pointers show maximum and minimum readings. (Pacific Transducer)

THERMOSTATIC (BIMETALLIC)

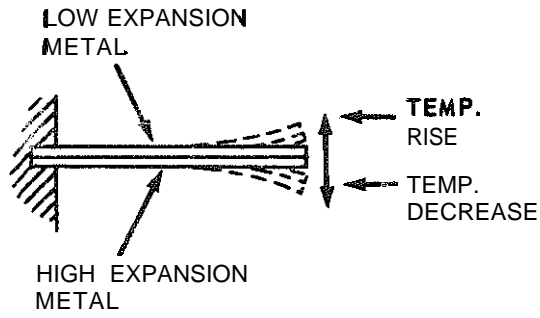

a

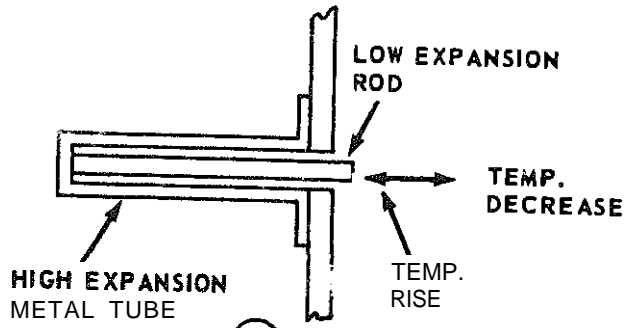

2

b

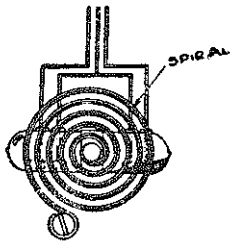

c

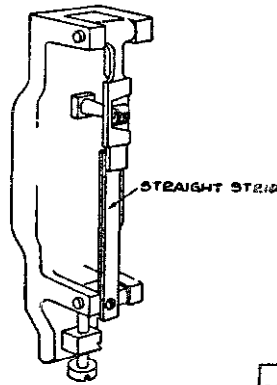

d

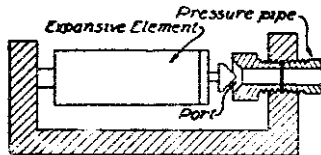

e

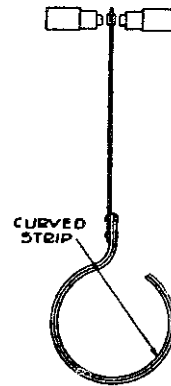

f

g

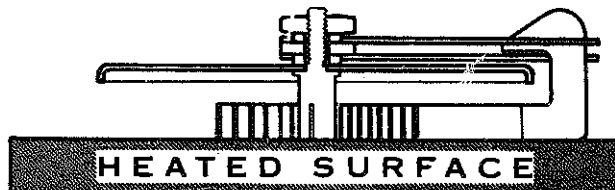
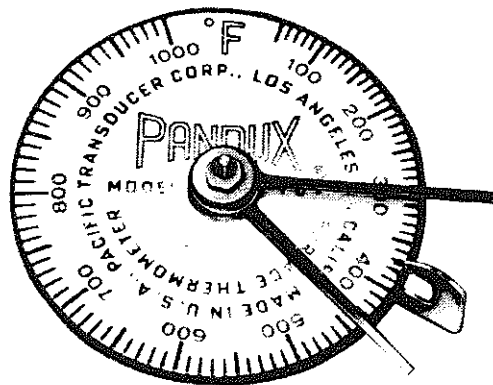

**C-Temperature**

**4-PYROMETERS** - devices to convert heat energy into electrical energy, to simplify the temperature reading.

**a-Pyrometer with thermocouple as sensing element.** The electrical output of the thermocouple is a function of the measured temperature, and is read off the calibrated meter scale directly in degrees.

**b-Optical pyrometer.** Principle: Observe temperature of furnace wall through peephole and compare radiation received with calibrated reference source. Slide wire resistor adjusts brightness of lamp to match that of image and potentiometer calibrated to read temperature is balanced against variable resistor. (Leeds & Northrup Co.).

1. source of radiation
- 2,3. objective lens with aperture
4. absorption filter
5. pyrometer lamp
6. red filter
- 7,8. microscope lens with aperture
9. eyepiece
10. observer
11. electric measuring instrument

**c-Thermopile sensor.** Heat source enters at "A", and is focused by mirror "B" on surface "G" where it can be seen from "F". Part of energy goes through hole "C" to mirror "D" and is focused on thermopile "E". Cold junction of "E" is housing. Disc temperature rises until rate of heat loss equals rate of absorption from source. Millivolts from pile are calibrated in degrees. (Rayotube Div., Leeds & Northrup Co.).

**d-Cryogenic probe.** For measurement of liquid and gaseous helium, hydrogen and oxygen. (Trans-Sonics Inc.).

# PYROMETERS

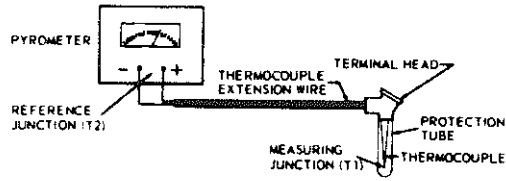

a

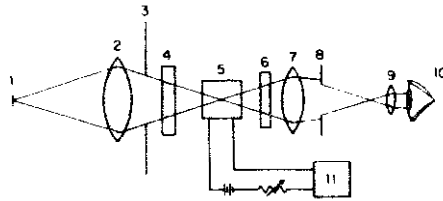

b

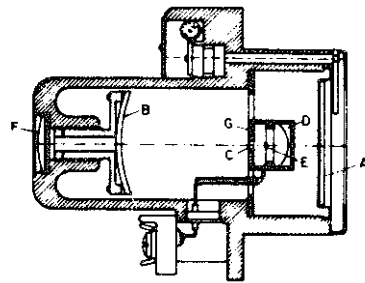

c

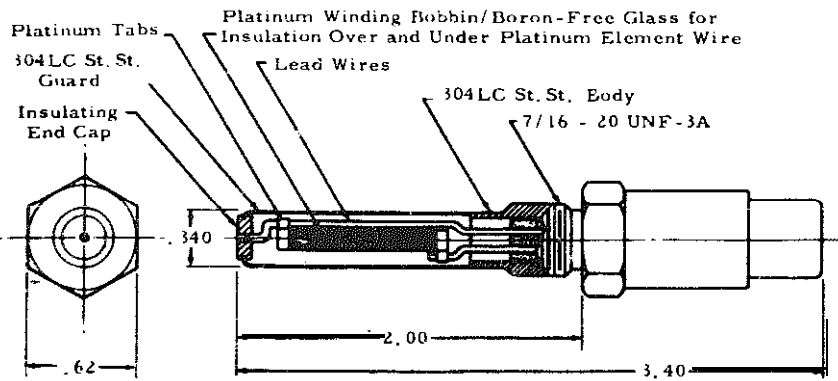

d

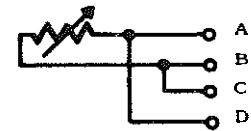

Schematic

**D-Force and Torque**

**1-SENSING ELEMENTS** - bending, deformation, and twisting in the elastic range are used to sense force.

**a-Cantilever beam.** Deflection within elastic range related to applied force.

**b-Simply supported beam.** Same as "a".

**c-Clamped-clamped beam.** Same as "a".

**d-Standard proving ring.** Same as "a".

**e-Proving frame.** Same as "a".

**f-Solid cylinder column force sensing element.** Maximum deflection at vertical center.

**g-Rectangular cylinder** with stress concentration hole for larger deflection. Shows compression and tension forces.

**h-Hollow strain tube.** Same as "f".

**j-Placement of resistance strain gages on column.**

**k-Solid cylindrical shaft for torque sensing.** Angular deflection (twist) related to applied torque.

**l-Torque sensing shaft with square notched section.** Shaft more pliable and square section permits simple mounting of strain gages.

**m-Rod-bridged notch torque sensing shaft.** Shaft more pliable, larger deflection. Comment as in "k".



**SENSING ELEMENTS**

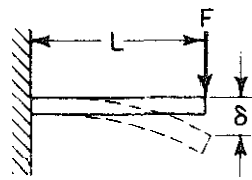

**a**

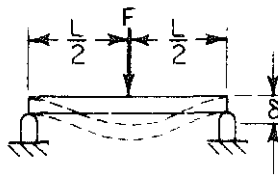

**b**

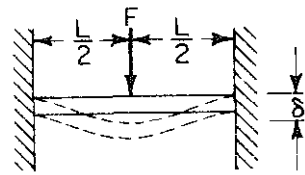

**c**

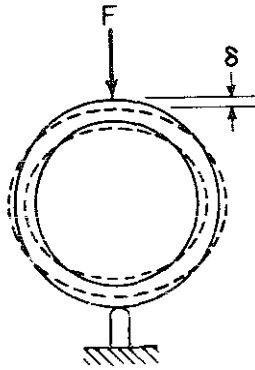

**d**

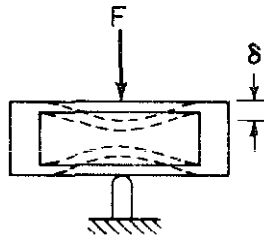

**e**

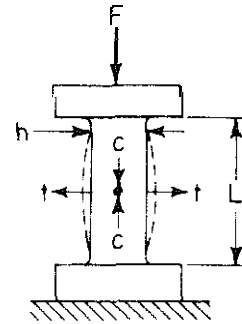

**f**

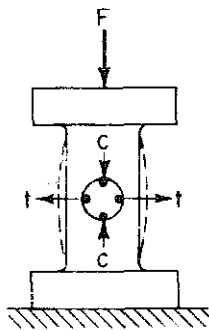

**g**

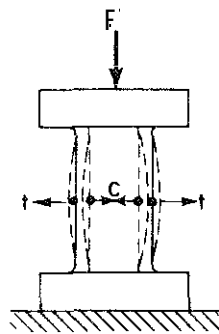

**h**

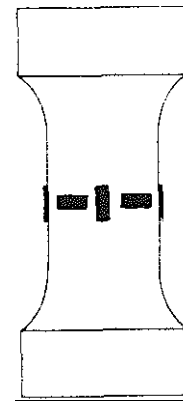

**i**

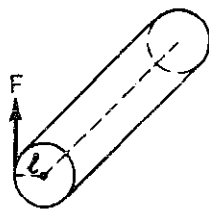

**k**

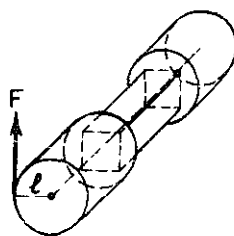

**l**

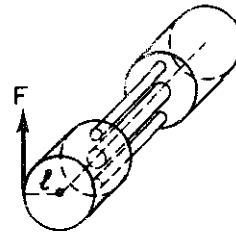

**m**

**D-Force and Torque**

**2-STRAIN GAGES** - the resistive strain gage is the widest used device for strain measurements. Changes in resistance due to strain are converted into voltage changes by means of a wheatstone type bridge. Its output is a measure of the strain.

**a-Bonded wire strain gage.** Most widely used type. The thin wire pattern is cemented to the base.

**b-Wire rosette.** To measure strain in various directions.

**c-Helical wrap-around grid type.** Wire wound around core.

**METAL FOIL STRAIN GAGES** - grids consist of very thin foil, with parts etched away. Foil materials are constantan, nickel chromium alloys etc. Grids are usually cemented to a carrier base.

**d-Grid of metal-foil strain gage.** Widely used type. Tabs facilitate soldering etc. (The Budd Co., Instruments Div.).

**e-Spiral foil gage.** To measure tangential strains in diaphragms. (Gulton Industries).

**f-Stress strain foil gage.** Two elements at  $90^\circ$  to each other to measure strain in two directions, if used individually. If connected in series, stress will be measured along principal gage axis. (BLH Electronics).

# STRAIN GAGES

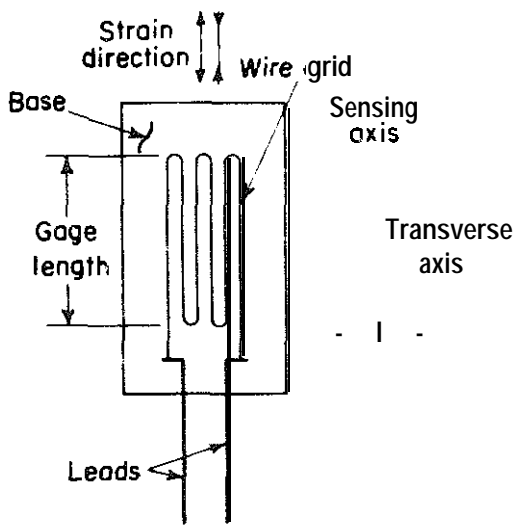

a

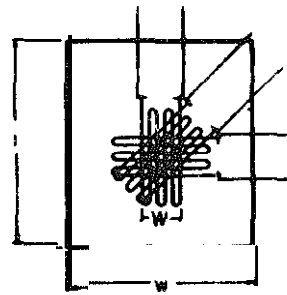

b

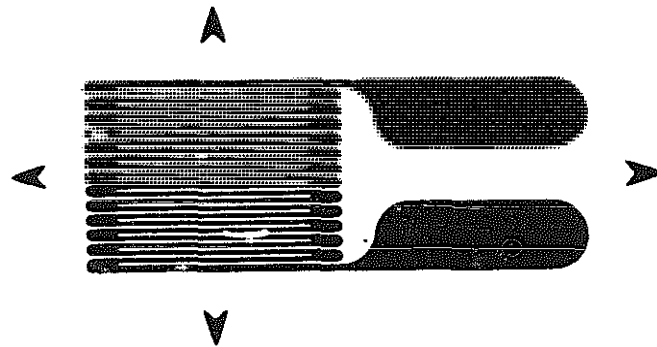

d

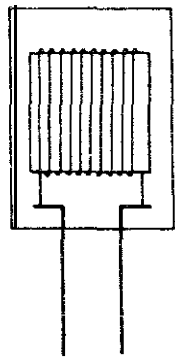

c

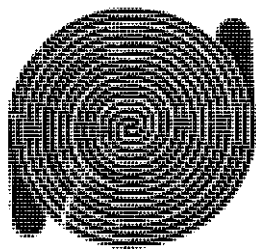

e

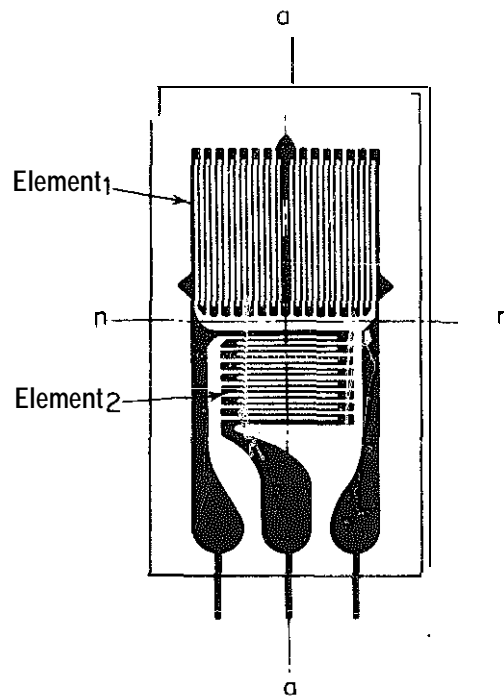

f

D—Force and Torque

3—INSTRUMENTS

**a-Strain-gage force transducer**, universal type, uses bonded strain gages. Internal threads permit use for compression or tension. Instrument used for sensing uses either proving ring or column (*illustration shows both.*) (BLH Electronics).

**b—Assembled unit “a”.**

**c-Torque transducer, reluctance.** X-shaped coil assembly has four secondary coils at the end of the x-legs, and one primary in the center of the x. With torque applied, coupling increases to one pair of secondary coils, and decreases to the other pair. (Bergen Laboratories).

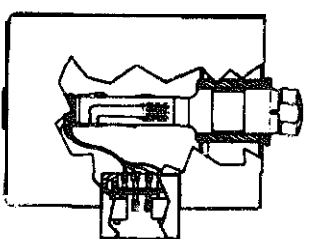
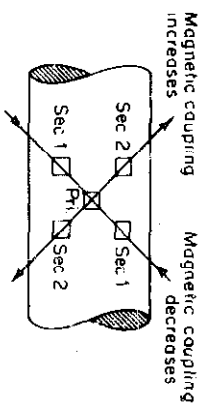
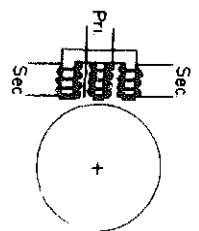
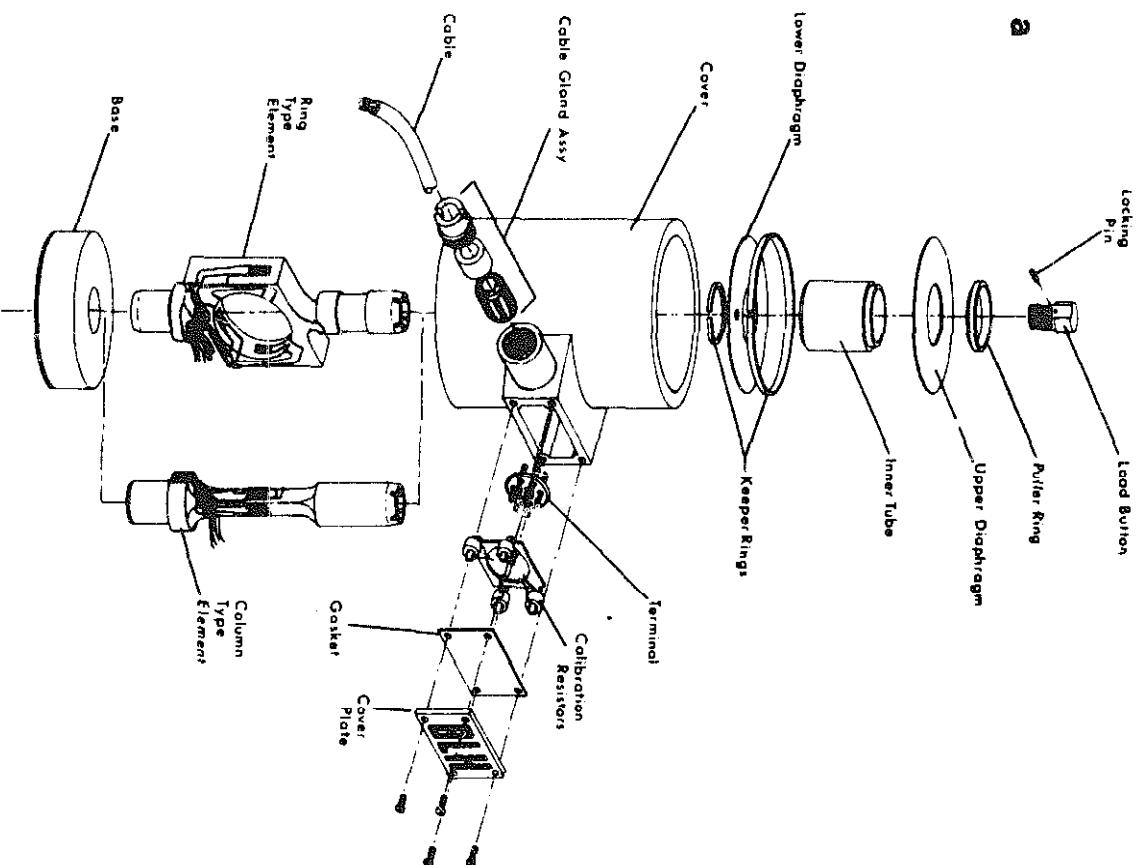

b

c

**D -Force and Torque**

**3-INSTRUMENTS (cont)**

**d-Piezoelectric force, transducer** used for dynamic force measurement. A washer type transducer, with the sensing element an annular column of sandwich type construction. Unless preloaded, unit responds only to compression. No excitation required. (Kistler Instrument Corporation).

**e-Variable reluctance load cell.** Spring centered ferrite disc armature, sandwiched between ferrite core inductors. Motion of cell cap changes air gap distances, and creates voltage changes in excited inductors. Read out from meters or recorders. (W.C. Dillon Co.).

**f-Reluctive force transducer.** Sensing by means of proving ring. Relative motion of dual coils and U-armature varies respective gaps. Coils form part of an impedance bridge. (Pace-Wiancko Div., Whittaker Corp.)

**g-Magnetostrictive type.** Used for high pressures. A stack of laminations is bonded together; there are four holes through the laminations, symmetrically spaced, through which two coils are wound at  $90^\circ$  to each other, and  $45^\circ$  to the load axis. With a-c fed to the primary, and a secondary voltage appears only if the cell is stressed.

**h-** (1) Flux lines in unstressed condition.  
(2) Flux lines in stressed condition.

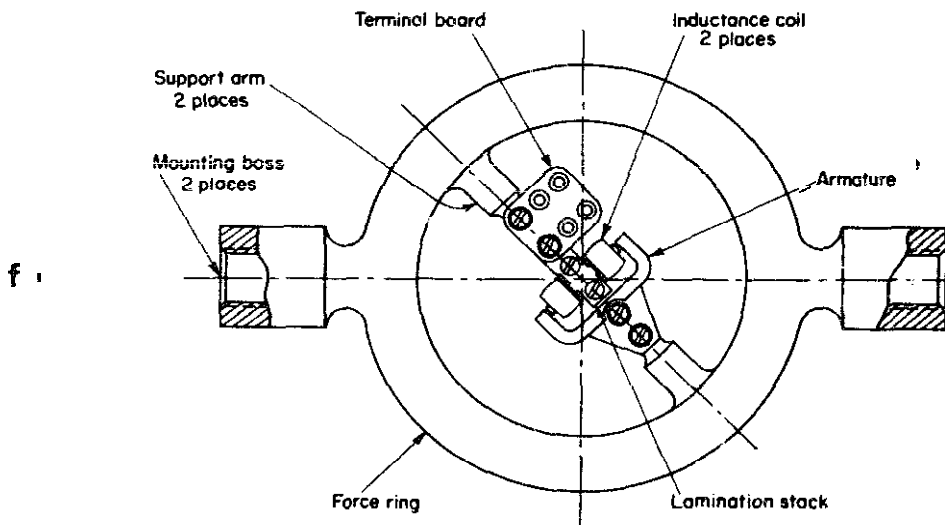
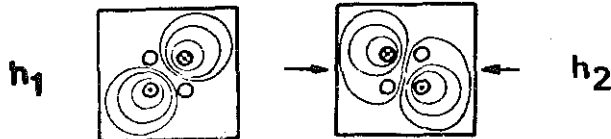
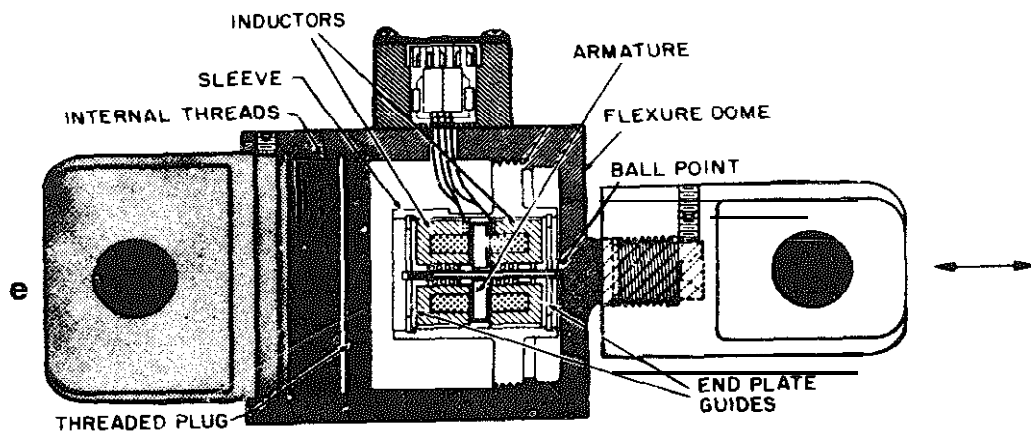
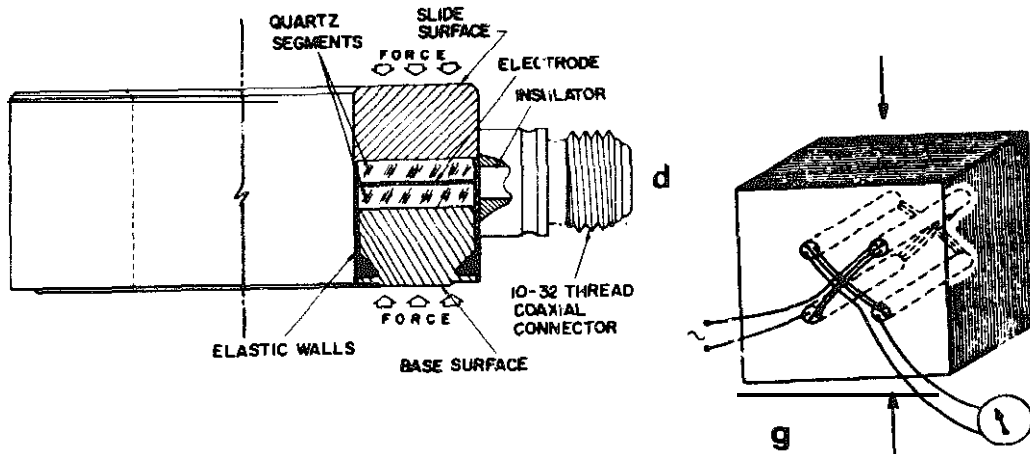

## E—Velocity and Acceleration

**I-ELECTROMAGNETIC TYPE** - Change of magnetic flux lines induces electromotive force in conductor. Change is obtained through motion of core in a coil or motion of coil over conductor.

**a-Electromagnetic velocity transducer.** Motion of core, which is connected to measurand changes output of coil proportional to object speed.

**b—Electrodynamic pick-up (seismic type).** Permanent magnet is suspended between two springs in a sleeve housing. Suspended system has low frequency resonance, and if vibration of measurand is higher, magnet remains in fixed position (relative), while case with coil vibrates about it; output indicates velocity, which is the time rate of change of displacement. (Consolidated Electroynamics Corp.)

**c—Differential transformer.** Movable magnetic core position governs mutual inductance between excited primary and secondary series opposing coils. (Automatic Timing and Controls Inc.).

**d-Toothed rotor tachometer.** Transduction coil is wound on permanent magnet. As the magnetic steel tooth passes, the flux lines of magnet shift so that they cut the coil windings, and a pulse results. A frequency counter displays pulses per unit time, i.e. revolutions per second.

**e—Typical coil assembly for “d”.**



**ELECTROMAGNETIC**

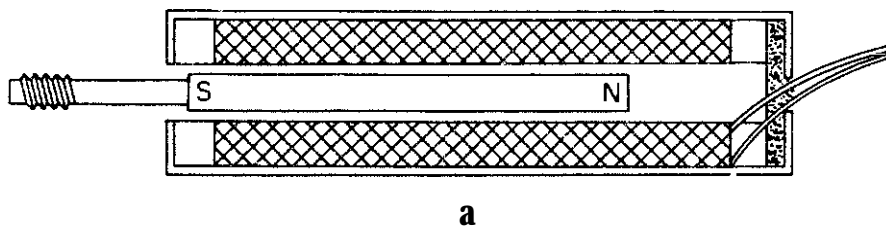
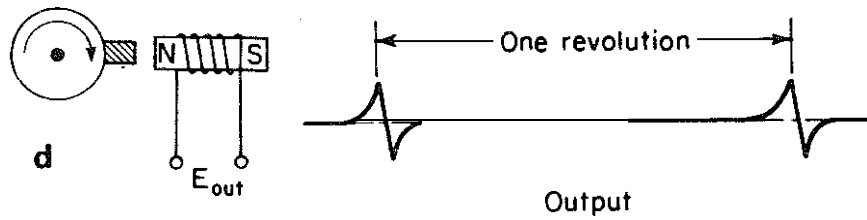
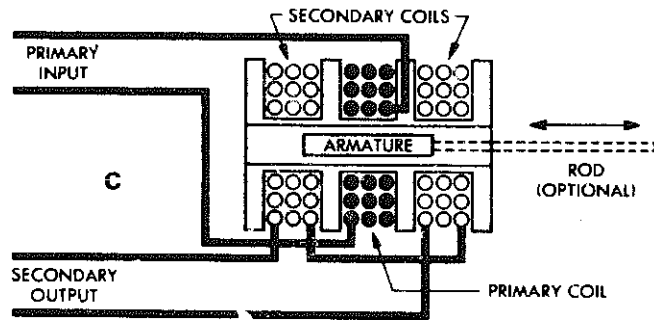
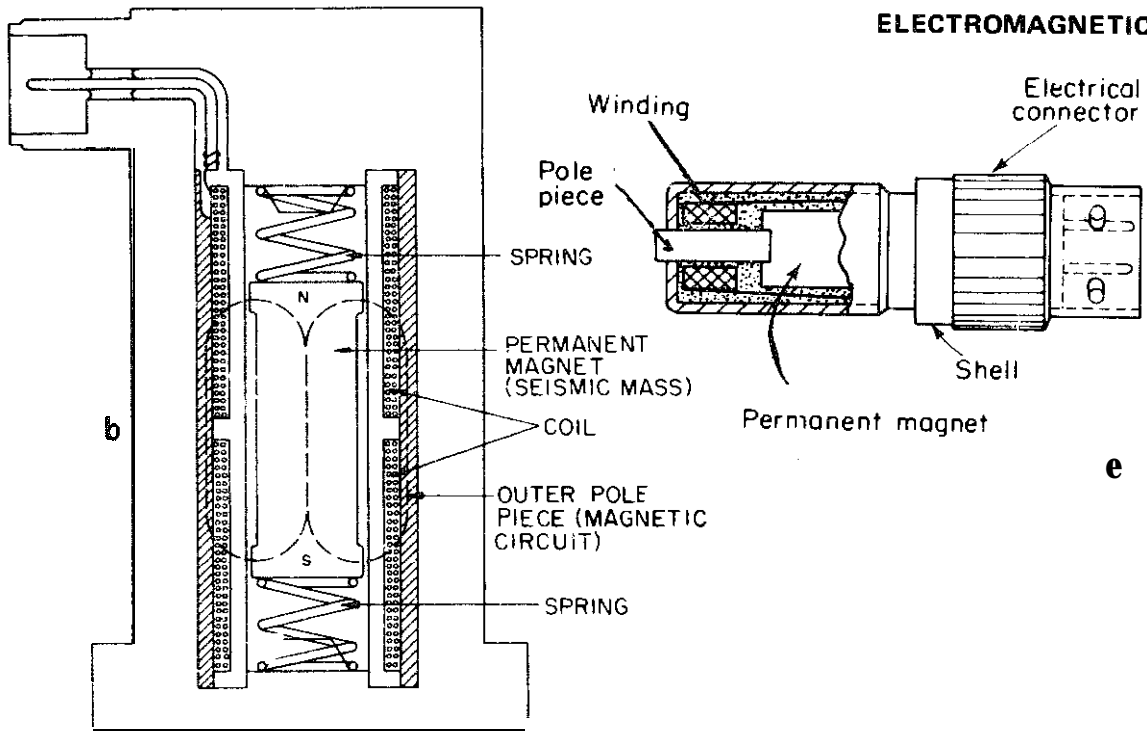

## E—Velocity and Acceleration

### 2—MISCELLANEOUS TRANSDUCER TYPES

**a—Angular strain gage type.** Two strain gages forming part of a bridge circuit are mounted on sensing beam. Sinusoidal output obtainable. Angular velocity of eccentric disc determined from frequency of the resulting sine wave.

**b—Basic damped spring-mass system** of an accelerometer. Seismic mass is the sensor, which is retained by a spring and damper. Mass moves relative to housing, when housing is accelerated; the higher the acceleration, the greater the relative displacement.

**c—Piezoelectric accelerometer.** Sensing axis perpendicular to base. Crystal “K” and basic housing “K” form most of spring design. “M” is the seismic mass. (Endevco)

**d—Same as “c”,** except curved spring is added as elastic member. (Endevco)

**e—Quartz-crystal piezoelectric accelerometer.** Several quartz crystals are stacked for higher output.

**f—Stretched wire linear accelerometer.** Mass supported by two wires. If case is accelerated along the direction of the wire axis, tension in one wire will increase, while decreasing in the other. Strain pick-off is in each wire and their sum is proportional to the acceleration.

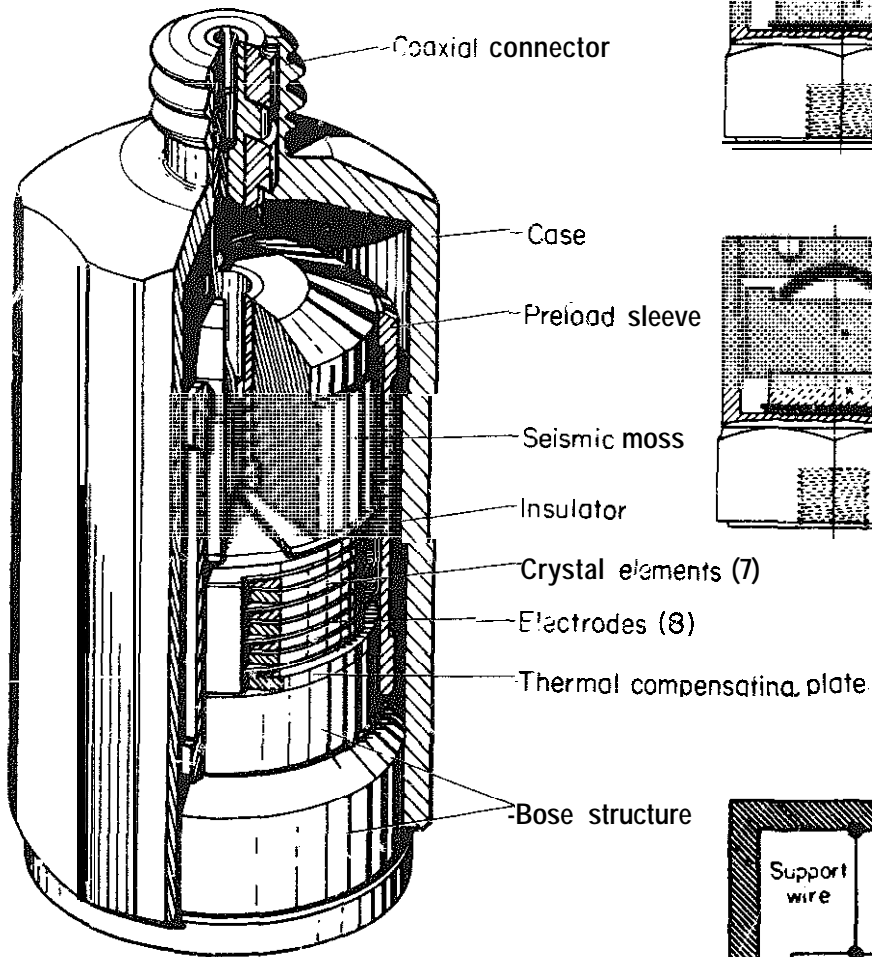
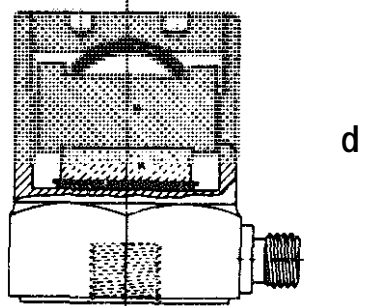
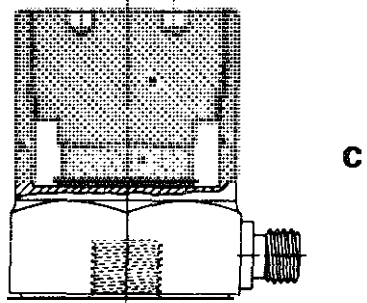
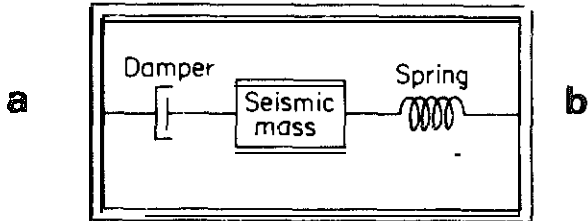
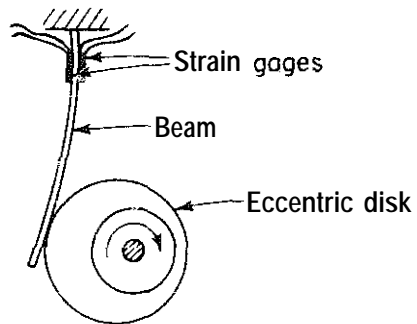

e

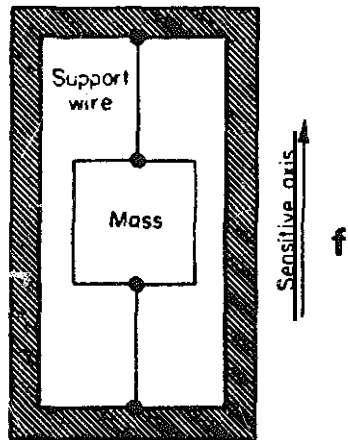

f

**X METROLOGY**

**A-Dimensional Measurement**

**1-SCALES**

**a - Tempered steel rule.** A six inch steel rule graduated in 8th and 16th, sides in 32nd. (Brown and Sharpe Mfg. Co.)

**b-Narrow tempered steel rule.** (Brown and Sharpe Mfg. Co.)

**c-Flexible steel fillet rule.** (Brown and Sharpe Mfg. Co.)

**d-Tempered hook rule.**

**e-Steel rules with holder.**

**f--Improved scale.** (Lufkin)

**g**—Simple type of **depth gage** for measuring depth of blind holes shoulders etc. This type is also available with a graduated round rod as scale.

**b**-Use of **combination square** to measure height of a block.

**j**—Use of **combination square** to locate center line of a cylindrical object.

SCALES

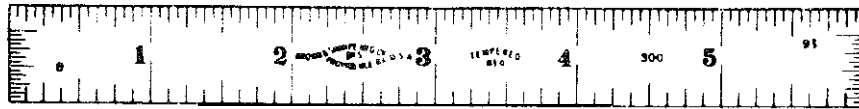

a

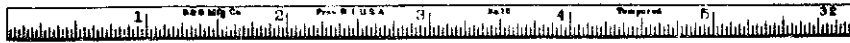

b

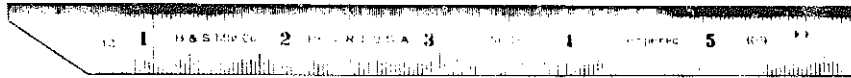

c

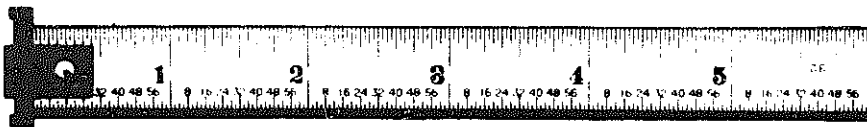

d

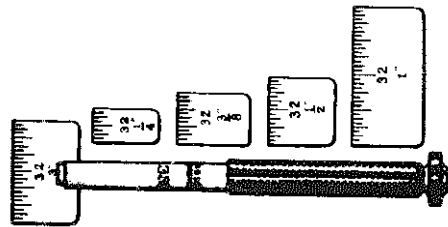

e

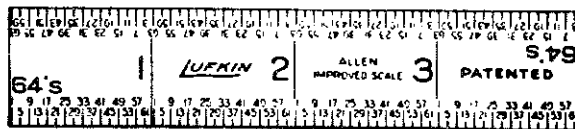

f

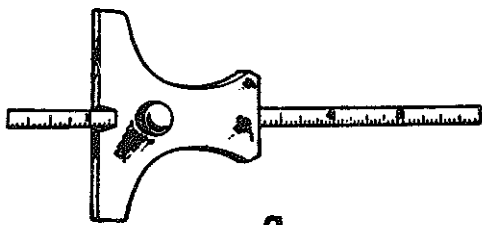

g

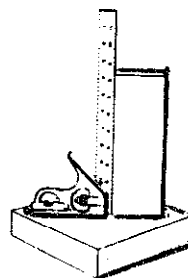

h



i

**A-Dimensional Measurement**

**2—MICROMETERS AND CALIPERS**

**a—Nomenclature for a micrometer**, reading to 1/1000 of an inch.

**b—Reading the micrometer.** The setting here is read as  $.100 + (.025 \times 3) + .009 = .184$  inches. The sleeve of the instrument has its major divisions represent 1/10th of an inch or .100 so that each subdivision represents .025 inches. Range of unit: from zero to 1 inch.

**c—Inside micrometer and attachment** for use in a range of three to four inches.

**d—Screw thread micrometer** and its application.

**e—Micrometer** for measuring the wall thickness of a pipe or tubing.

**f—Vernier caliper.** Fixed jaw A, rule B, moving jaw C integral with frame D, vernier scale E, clamp F locked by knurled screw G, knurled nut H moves sliding head (D, E, C), knurled screw I locking head to rule.

**g—Reading the vernier scale:** 2 inches (major scale) + .4 in. + .025 in + .011 in = 2.436 inches.

**h—Knife edge vernier.** Has jaws reduced to an edge.

**j—Application** of knife edge vernier.

**k—Internal construction** of inside micrometer. In the front of the micrometer is an extension rod. Several extension rods are used with the same micrometer to obtain various ranges, for example from 3 in. to 4 in. with one rod, and from 2 in. to 3 in. with another one.

**l—Vernier height gage.** A, base; B, beam; C, sliding head; D, scribe; E, F, faces; G, attachment for measuring hole depths.

**m—Checking a surface height** with a Vernier height gage.

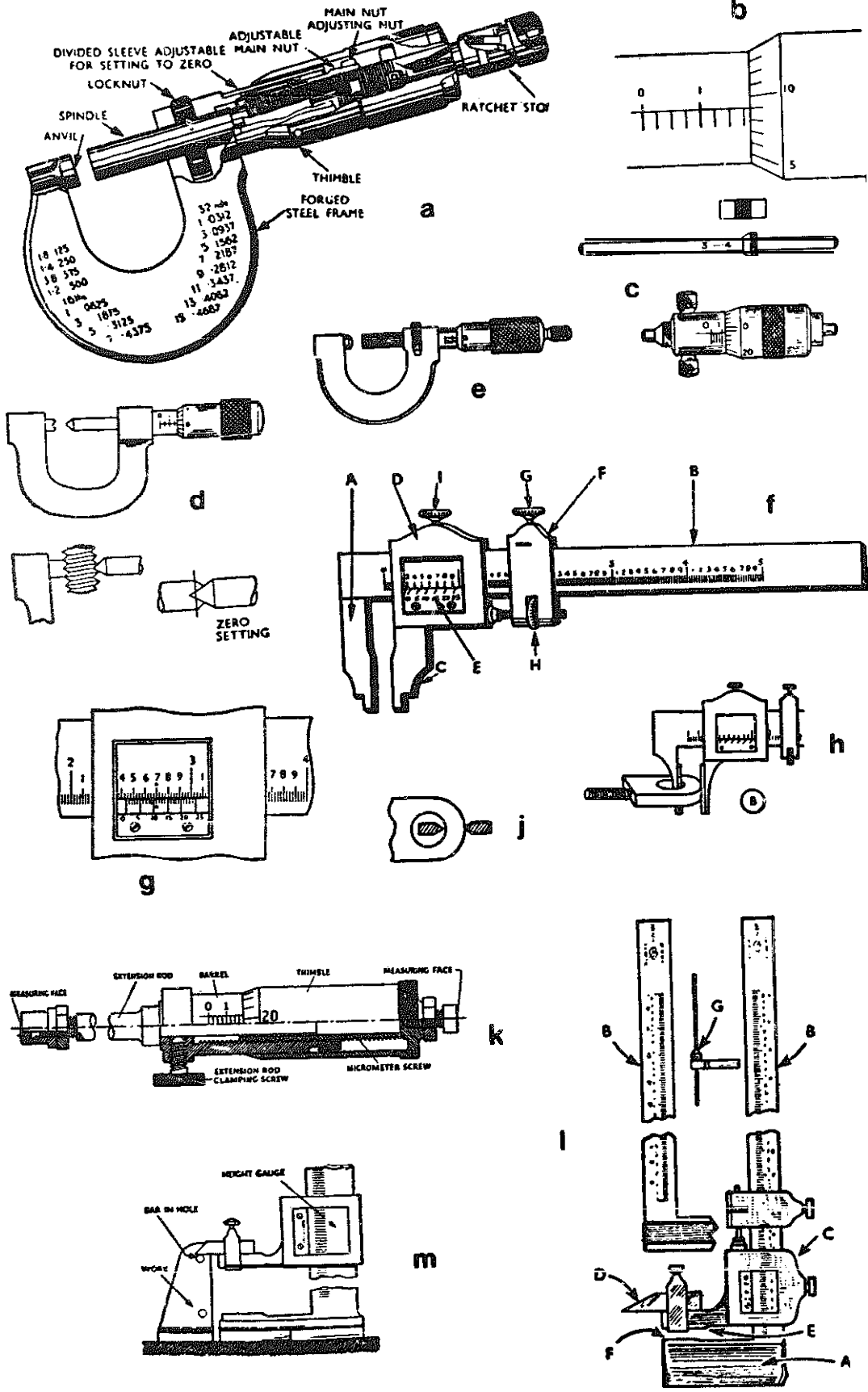



**A-Dimensional Measurement**

**2-MICROMETERS AND CALIPERS (cont)**

**n-Inside caliper.** The inside diameter is measured as shown. Caliper is removed and the dimension taken off by holding caliper against a scale or reading the setting with a micrometer if good accuracy is required.

**p-Outside caliper.** Procedure similar to "n".

**q-Using a Hermaphrodite caliper.**

**r-Transferring reading** of hermaphrodite caliper to a scale to read the dimension.

**s-Inside micrometer calipers.** (L.S. Starrett Co.)

**t-Detail of jaws** for "s".

**n--Outside micrometer calipers** with interchangeable anvils. (L.S. Starrett Co.)

**v-Tube micrometer caliper.** (L.S. Starrett Co.)

**w-Inside-outside pocket slide caliper rule.**

**x-Gear tooth caliper.** Used to measure the chordal thickness of teeth at the pitch circle.

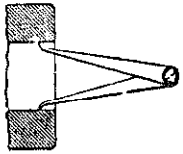

n

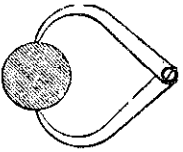

p

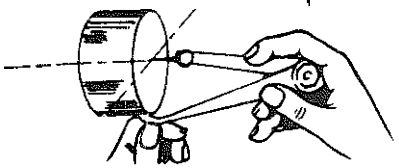

q

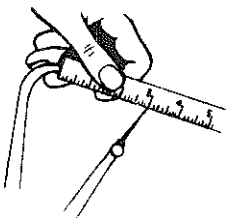

r

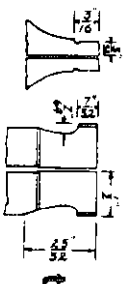

t

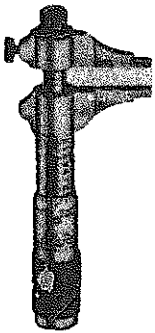

s

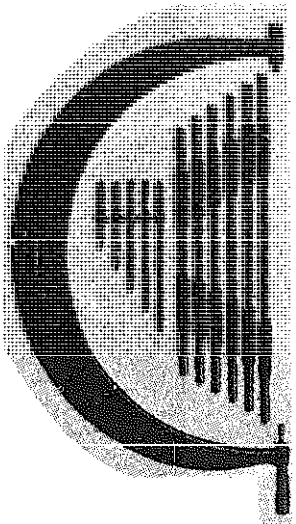

u

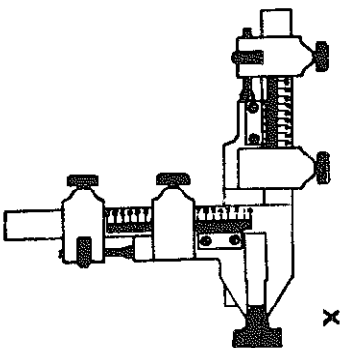

x



w

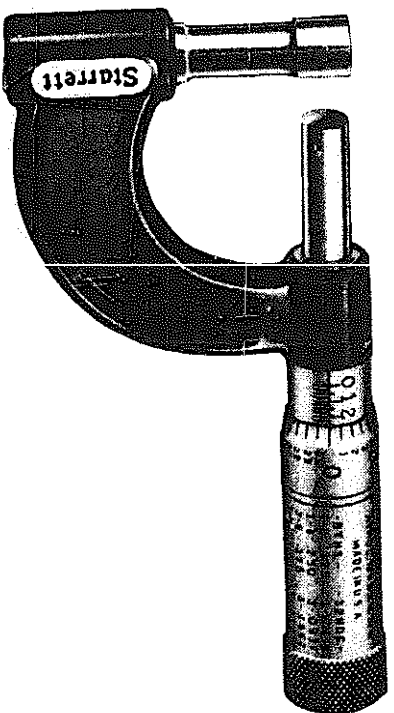

v

**A-Dimensional Measurement**

**3-GAGES**

**a-Plug gage**, one end is “go”, the other end “no go”.

**b,b1-Limit gage**, “go” and “no go” gage.

**c-Using snap gage** on objects with parallel sides.

**d-Using snap gage** on cylindrical object.

**e-Taper plug gage**. Tapered hole is correct since only one mark shows. If no marks are visible tapered hole is too large., if both marks show, hole is too small.

**f-Spline plug gage**. They are used to check splined holes in gears and collars operating on splined shafts.

**g-Same as “f”**.

**b-“No go” thread gage** checks diameter of thread in nut.

**j-Adjustable caliper snap gage** is set to dimension with gage blocks.

**k-Temporary snap gage** made from parallels, a frame and gage blocks.

**l-Radius gage** measuring inside radius. (Fillet)

**m-Radius gage** measuring radius of corner.

**p,q-Ring and plug thread gage**.

**r-Screw pitch gage**.

**s-Use of screw pitch gage**.

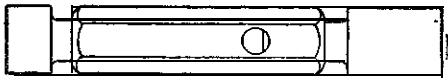

a

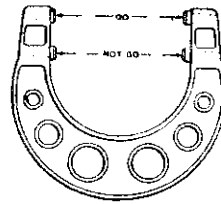

b

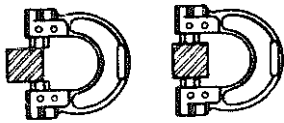

c

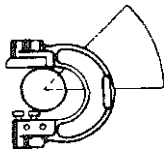

d

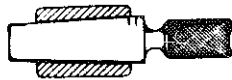

e

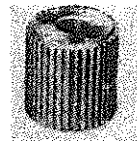

f



g

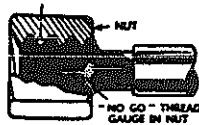

h

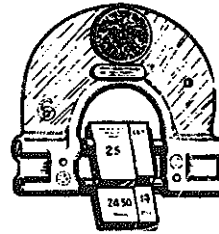

i

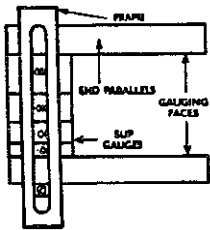

k

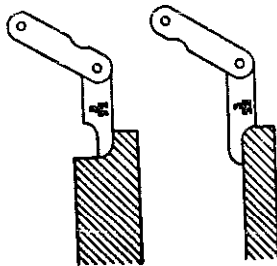

l

m



p

q



r



s

## A—Dimensional Measurement

### 3—GAGES (cont)

**t—A set of feeler gages.**

**u—A set-up of a casting using feeler gages.**

**v—Micrometer plug gage.**

**w—Woodruff keyway gage.**

**x—Flat plug gage.** Used to check width of slots.

**y—Ring gage**

**z—Small hole gage.** Measuring surface consists of a split ball, adjusted to size by a knurled knob. Final size measured by micrometer.

**aa—Telescoping gages.** The contact plungers are telescoping working under spring pressure. Turn of handle locks them into position. Micrometer is used to read dimension.

**ab—Micrometer depth gage.**

**ac—Toolmakers' surface gage**

**ad—Dial indicator.**

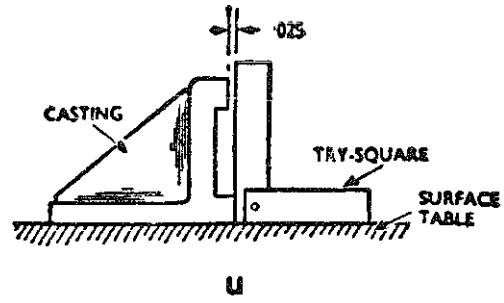
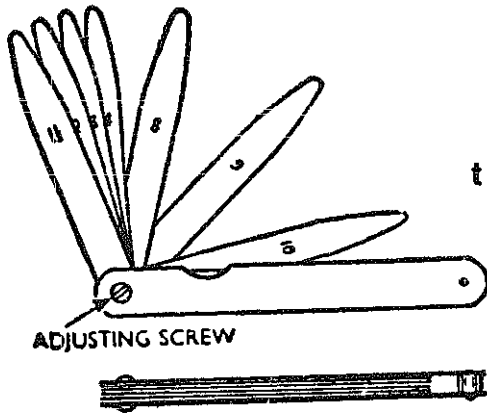

v



w



x



z

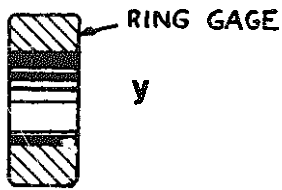

y

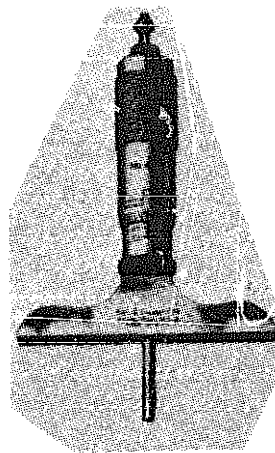

ab

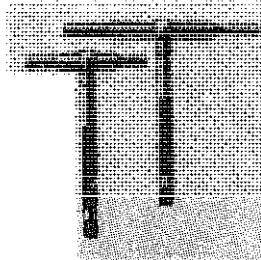

aa

ad

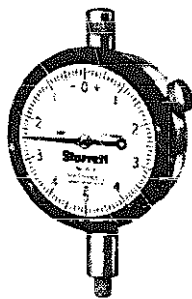

ac

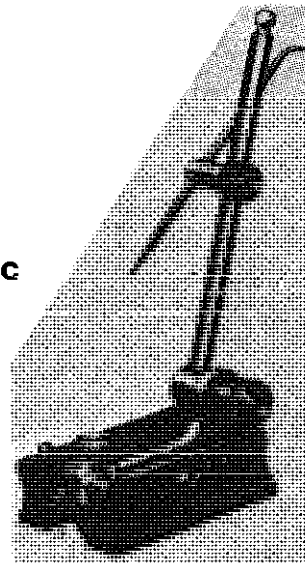

**A-Dimensional Measurement**

**3-GAGES (cont)**

**ae-Radius** gage checking internal radius.

**af-Radius** gage checking one half of circumference of a rod.

**ag-Three wire method** of thread measurement. Three hardened special wires are placed in the threads and measurement is taken over the wires. Best wire size for threads must be used. Obtainable from tables. Then formula must be used.

**ah-Dial indicator** with tolerance pointers

**aj-Electrolimit** gage. Each graduation of gage is .00005 inches. Used for laboratories. Accuracy is checked with gage blocks.

**ak-Planer** gage. This gage with a scribe can be used for layout work.

**al-Gage blocks.** They are manufactured in various guaranteed degrees of accuracy, for example  $\pm .000002$  inches.

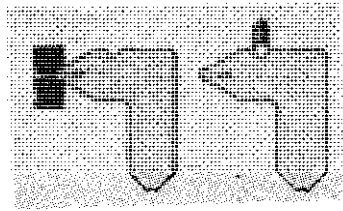

ae

af

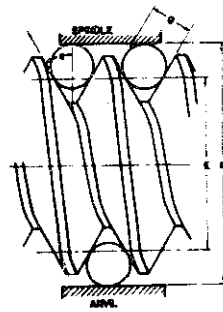

ag

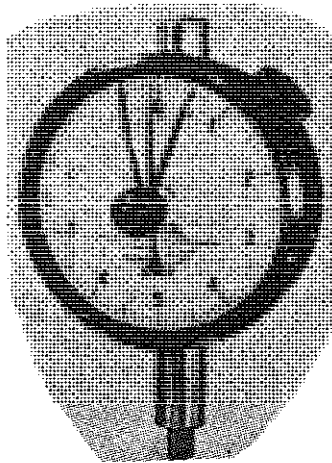

ah

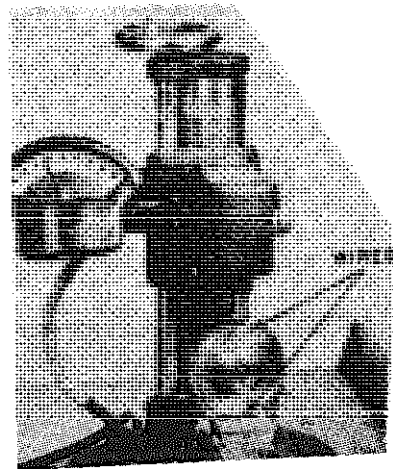

aj

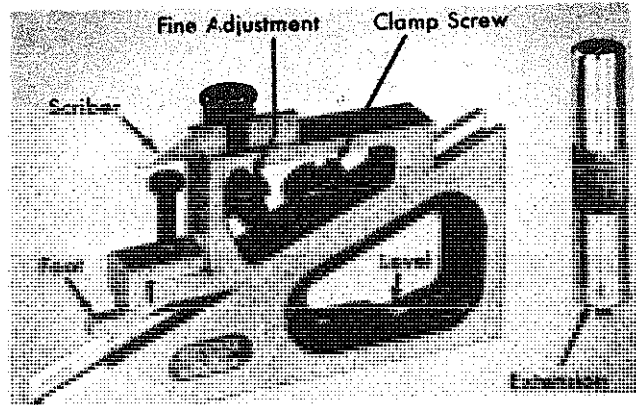

ak

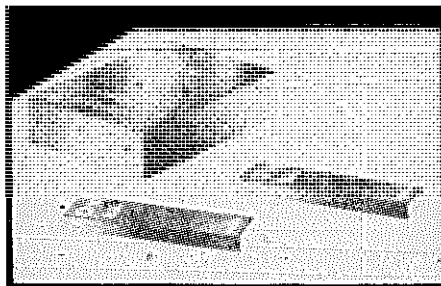

al



**B-Volume, Weights and Area**

**1--MEASURING VOLUME AND AREA**

**a - Double slide measure.** Pivoted first class lever shown just after discharging fixed volume. Swinging lower end of lever in, blocks chute at a given height and permits filling up chute for next cycle.

**b-Automatic tipping scale;** when filled up to the correct weight it falls and tips by striking a fixed stop. The scale then returns to its original position and is refilled.

**c-Automatic measuring device;** the material fills one compartment until it overbalances; then it falls and is emptied; the material then fills the other compartment; and the alternating motion continues while the feeding of material proceeds.

**d-Measuring tap for liquids.** Fluid is forced at given pressure into spherical container; then the rotary valve is rotated  $90^\circ$ . Sphere discharges, valve is turned back and the process is automatically repeated.

**e-Automatic feeder.** Rotation of drum controlled by timer.

**f-Weighometer** for automatically weighing any material passing along a horizontal belt, pan or conveyor.

**g-Rotary disc water meter.** Has circular metering chamber, divided into two sections by "nutating disc". Motion of upper end of disc shaft operates counting gears.

**h-Worthington piston water meter.**

**j-Planimeter.** To determine surface area of an object or area inside of a closed curve. It has two pivoted arms, the pole arm between pole P and pivot O, and the tracing arm between tracer T and pivot O. The pole is fixed in position while the tracer follows the outline of the curve. The amount of rotation of the recorder wheel is related to the area traced, and is indicated by the recorder wheel W.

**k-Orifice-and-plug steam meter.** Position of tapered plug determines the area and mass of steam passing. Has pointer and strip chart recorder.

**l-Revolving drum condensate meter with gravity discharge.**

**m-Air-operated gage;** most suitable for the measurement of a large number of identical articles; it can be used as a thickness gage, a plug gage, or a ring gage; a special feature apart from its accuracy is the absence of wear on the gage unit; a common plug gage becomes useless after a certain number of passes, while a plug gage is considerably smaller than the part to be measured, never comes in contact with part to be measured, and thus it is not subject to wear.

# MEASURING VOLUME & AREA

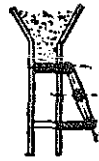

a

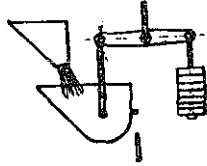

b

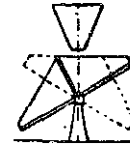

c

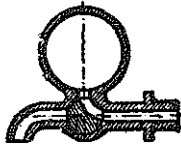

d

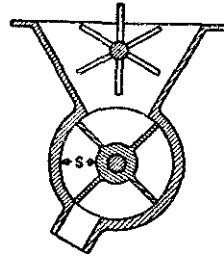

e

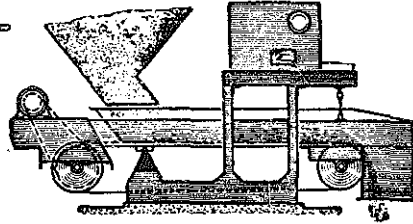

f

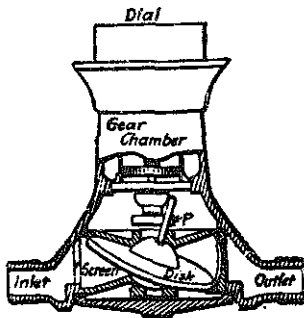

g

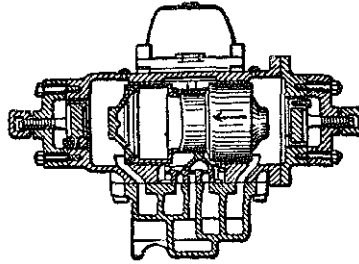

h

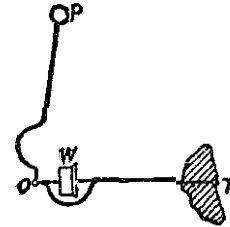

i

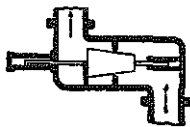

k

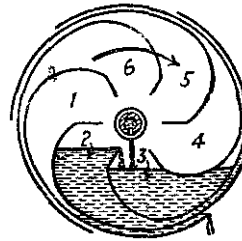

l

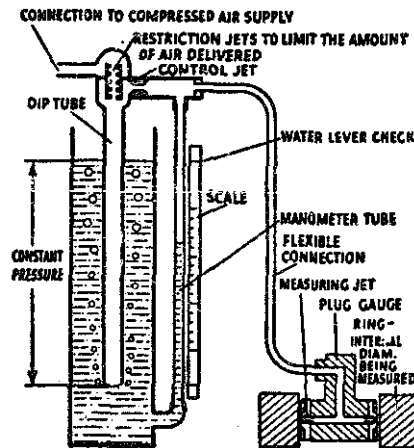

m

**C-Pressure and Weight**

**I-MEASUREMENT OF PRESSURE**

**a-U-tube or manometer** for determining low gas pressures. The bend is filled with the manometer liquid. Under application of pressure to one leg, the other open to air or connected to another pressure source, the liquid will rise in one leg and sink in the other.

**b-Bourdon tube-gage** mechanism assembly. Under application of pressure tube tries to straighten out, thereby actuating the gear and pointer assembly.

**c-Bourdon tube**, the basic pressure element of "b".

**d-Diaphragm gage**; the sensitive element is a corrugated disc of thin metal which, being held at the periphery, is deflected by a difference between the pressures on the two sides.

**e-Reciprocating engine or compressor indicator.** Pen arm positioned by pressure, while chart drum is oscillated by mechanism under test.

**f-Metal bellows** are used as the heart for many pressure instruments.

**g-Inclined draft gage.** For very low pressures. It is actually a U-tube, but the right leg is expanded into a reservoir, while the left leg is an inclined tube with a small bore.

**h-Aneroid barometer**; vacuum chamber unit, showing diaphragms built up to form the unit.

**j-Precision aneroid barometer** movement.

**k-Altimeter**: used to measure height of small air craft above ground. Also used by surveyors.

**I-Cistern type manometer.** Action similar to draft gage "g".

**m-Inverted U-type manometer.** Here corrections should be made for the height of the column.

**n-Differential manometer** using two types of fluids.

*Note: For additional material see Section IX, under pressure transducers.*



C—Pressure and Weight

2—BALANCES AND SCALES

**a-Spring balance.** Based on linear deflection of spring, following Hook's law. Displacement is converted directly into force or weight.

**b-Circular spring balance mechanism.** In this rack and pinion arrangement, deflection is used to turn pointer on pinion shaft.

**c—Small hand balance.**

**d—Original form of the Roberval balance;**  $h_1 = h_2$  irrespective of the horizontal positions of equal weights.

**e-Roberval balance;** diagram of forces acting on leg.

**f—Beranger balance.**

**g-Steelyard weighing machine.**

**h-Self-indicating weighing machine;** in its simpler form, the scale is not linear, i.e., equal load increments are not indicated by equal divisions.

**j-Self-indicating weighing machine** with equal scale divisions for equal load increments; the tension rod is in the form of a flexible metal strip which operates on the periphery of a cam.

**k-Laboratory balance.**

**l-Trip scale** for rough weighing.

**m-Diai scale** for rough, quick weighing.

**n-Prescription weights;** made according to the specifications of the United States Bureau of Standards and the New York Board of Pharmacy; a set consists of 4, 2, 1 and  $\frac{1}{2}$  drams; 2 and  $\frac{1}{2}$  scruples; 10, 5, 2, 1,  $\frac{5}{10}$ ,  $\frac{2}{10}$  and  $\frac{1}{10}$  grains.

# BALANCES & SCALES



a

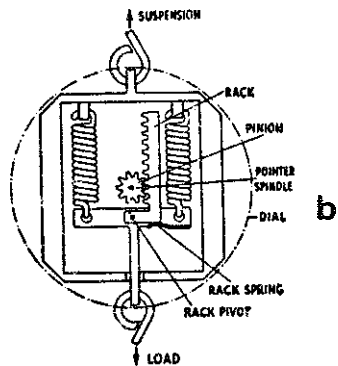

b

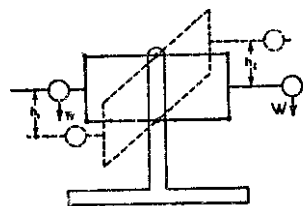

d

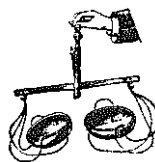

c

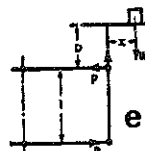

e

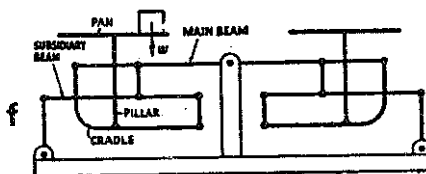

f

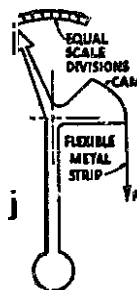

j

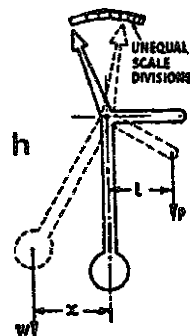

h

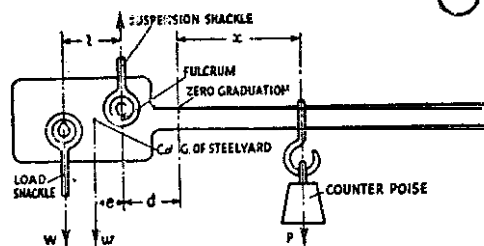

g

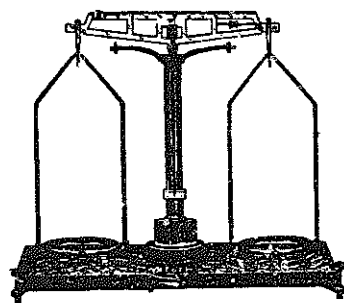

k



i



n

## X METROLOGY

### D—Torque and Temperature

#### 1--MEASUREMENT OF TORQUE AND TEMPERATURE

**a—Prony brake.** The prony brake applies load to the output shaft by means of a wood block. It consists of lever A, blocks B and B'. The blocks are positioned by a frame and held by nuts N. Since arm A tries to revolve, its push on the scale is measured on scale C. If small "w" is the weight of the arm on the scale without any force applied, and the moment arm is small "l", then the brake horsepower is  $2\pi l n (W - w)/33000$  where n is the number of revolutions per minute.

**b—Same** as "a", but more elaborate.

**c—Brake wheel** which permits water to go inside. The cooling effect is quite efficient.

**d—Simple rope brake.** If n is the number of revolutions per minute, r the radius of the flywheel, P the attached weights and Q the scale reading, the brake horsepower is  $2\pi rn (Q - P)/33000$ .

**e—Fan brake dynamometer,** used for high speeds.

**f—Typical curve to determine brake horsepower for "e".**

**g—Electric cradle dynamometer.** Generator with rotor and stator mounted in cradle. Stator free to turn and torque to prevent rotation measured by suitable scales.

**h—Beckman thermometer;** its sensitivity is about  $0.001^{\circ}\text{C}$ ; its range is extremely limited, about  $1^{\circ}\text{C}$ , but the position of this  $1^{\circ}\text{C}$  range can be varied at will over a wide range.

**j—Platinum resistance thermometer.**

**k—Wiring of platinum resistance-thermometer bridge.**

**l—Wiring of a thermocouple;** A and B are two dissimilar metals which are joined at their ends to form a circuit and if the junctions are kept at different temperatures, an electric current will flow in the circuit which can be measured by a galvanometer; one junction is placed in melting ice and the other in the temperature to be measured; up to  $300^{\circ}\text{C}$ , a copper-constantan couple is fairly sensitive; up to  $1500^{\circ}\text{C}$ , platinum-platinum rhodium is a satisfactory couple.

**m—Common domestic thermostat.** When the temperature decreases, the bimetallic strip moves to close a contact. Once contact is made, a relay in the circuit is actuated, turning on the heat.

**Note:** For more material on temperature, see section IX on transducers.

# MEASUREMENT OF TORQUE & TEMPERATURE

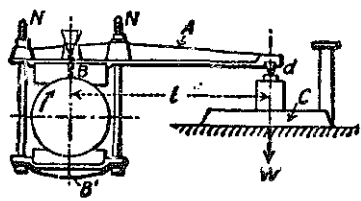

a

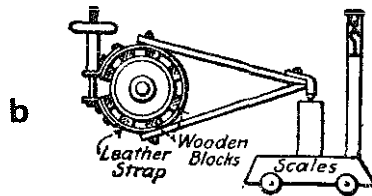

b

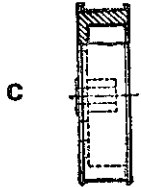

c

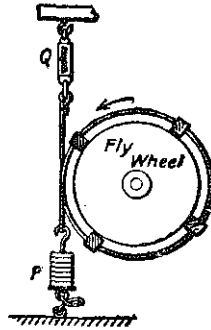

d

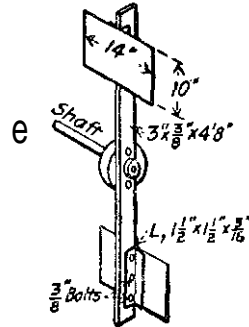

e

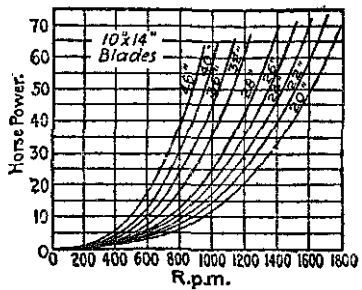

f

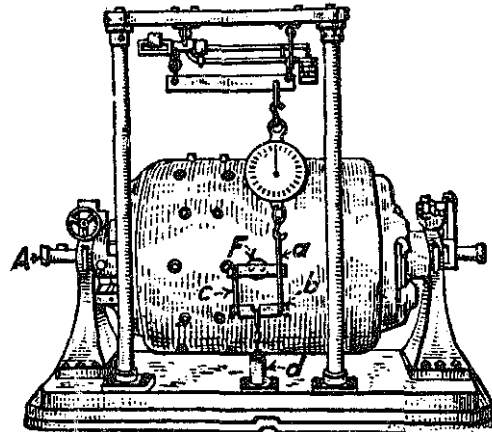

g

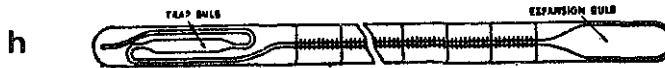

h

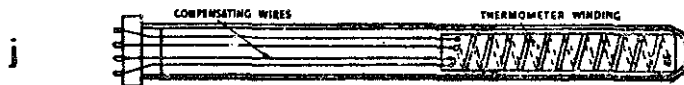

j

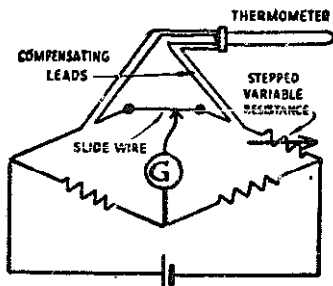

k

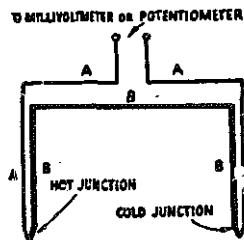

l

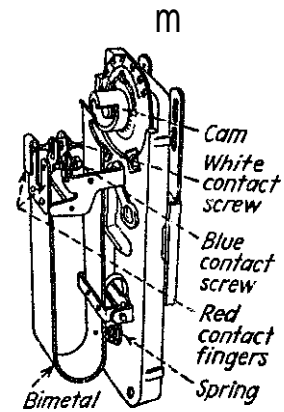

m



E-Velocity

1 -INSTRUMENTS FOR MEASURING VELOCITY

a-Principle of **air speed indicator**. It consists of an air-tight diaphragm capsule and a mechanism for multiplying its deflection. The static line brings air cabin pressure into the housing, while the pressure tube connected to the outside, transfers an air pressure whose magnitude is proportional to the square of the speed.

b-Principle of **centrifugal speedometer**. Centrifugal force turns governor arm with its connected sliding sleeve and sector gear. Sector gear turns pinion which in turn moves pointer.

c-Indicator to **register the flow** of water by its speed and pressure against a ball which actuates a pen, moving against a paper cylinder which is kept slowly revolving by a clockwork.

d-**Pitot tube** ; it measures velocity pressure and static pressure; the difference between the total pressure and static pressures gives the velocity pressure (VP).

e-**Stroboscopic disc**. The stroboscope is an instrument that utilizes persistence of vision of the human eye viewing an object intermittently. The intermittent flashes are very precisely controlled, thus viewing a cyclic motion at the same point in each cycle makes it appear to stand still.

f-**0-100 Speed indicator**. The rotating friction disc, is kept from turning by pressing raised knob. Tip of unit is put against rotating shaft. After one hundred revolutions of the spindle of the indicator, knob is felt passing under thumb. By watching the elapsed time, the speed can be determined. (L.S. Starrett Co.)

g-**Surface speed attachment** for speed indicator. Hold wheel against pulley for one minute. Divide the number of revolutions shown on the dial by two to obtain the surface speed of the pulley in feet per minute. (L.S. Starrett Co.)

h-Measuring speed with **electromagnetic pick-up**. Each time a gear tooth passes **the** magnetic pick-up, a pulse is created. If this pulse is fed into an Eput meter (Events per unit time) the exact number of pulses per second are counted by the meter and can be read off; this number, divided by the number of teeth in the gear, gives revolutions per second. (Electro Product Laboratories, Inc.)

j-Measuring speed with **magnetic proximity pick-up**. Solid state devices, utilizing a frequency discriminator change the alternating electrical input into a proportional d.c. output. D.C. meter is calibrated to read directly in revolutions per second. (Airpax Electronics, Seminole Div.)

# INSTRUMENTS FOR MEASURING VELOCITY

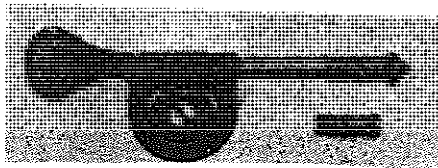
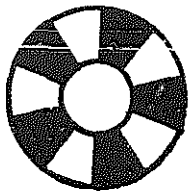
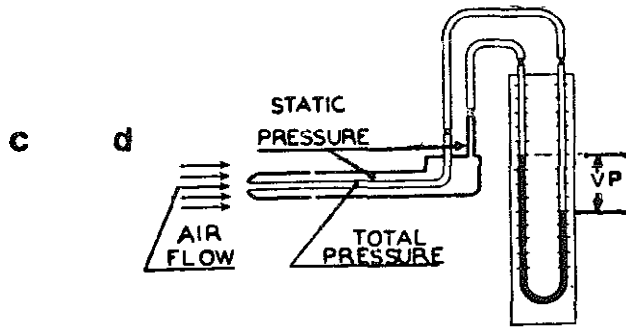
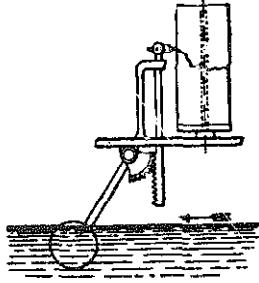
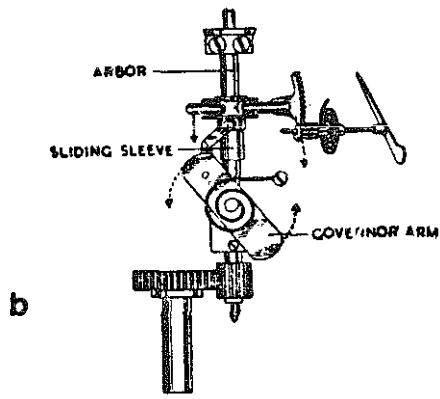
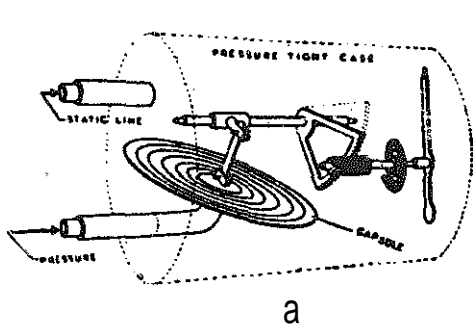

e

f

g

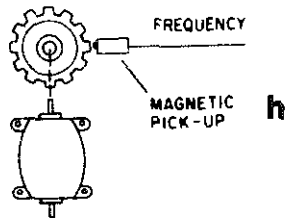

h

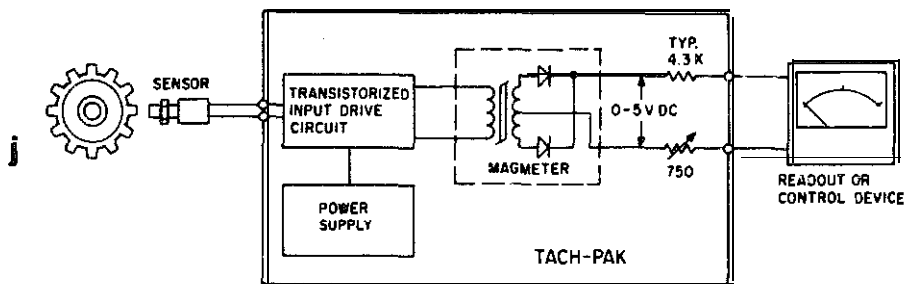

i

F--Angles

1--INSTRUMENTS

a-universal **drafting machine**, can be set for any angle.

b-Triangle used for drafting. The angles are 30°, 60° and 90°.

c--Adjustable **bench level**. Very accurate and sensitive. They measure if surface is level.

d-Plumb bob. Unless point of plumb bob is in line with its center of gravity, it will not center accurately.

e-Universal **bevel protractor**. A, base; B, disc; C, dial; D, datum line; E,F, clamping nuts; G, blade.

f--Reading the vernier of the bevel protractor. It reads 37° + (10 x 5) or 37° 50 minutes.

g-Combination square. A, blade; B, square head; C, center square; D, protractor head; E, scribe.

b-Sine bar, and its application.

j-10" sine bar set up for 30° angle.

$$\frac{6.000 - 1.000}{10.000} = .500, \text{the sine of } 30^\circ$$

k-5" sine bar set up for 30° angle.

$$\frac{3.500 - 1.000}{5.000} = .500, \text{the sine of } 30^\circ.$$

# INSTRUMENTS

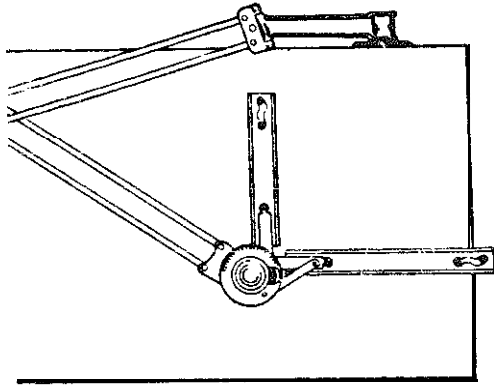

a

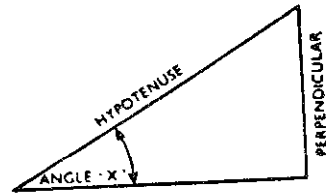

b

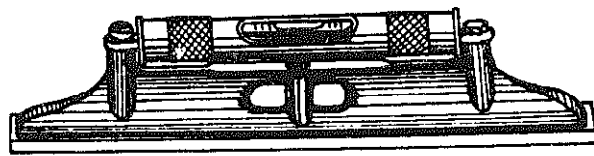

c

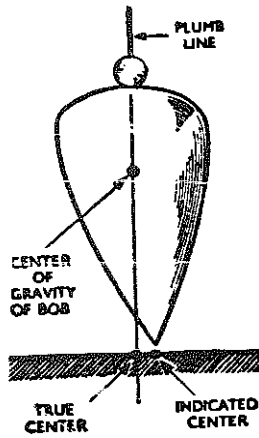

d

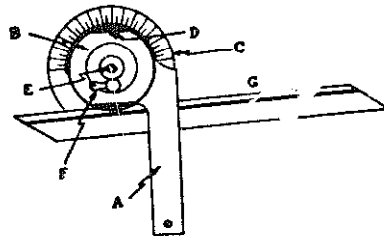

e

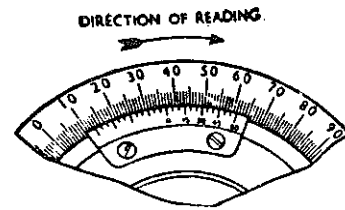

f

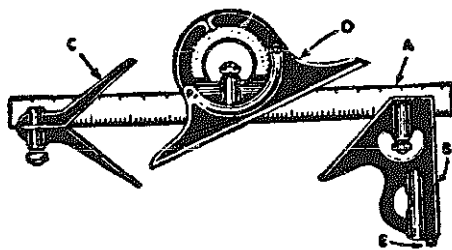

g

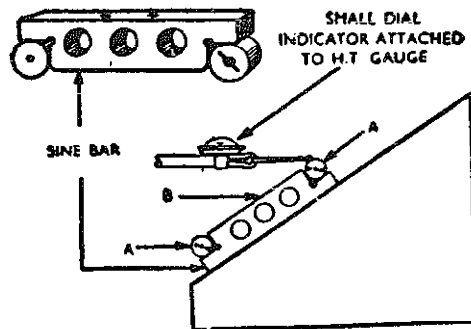

h

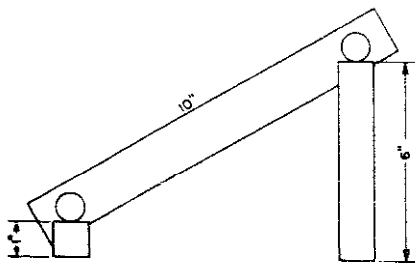

i

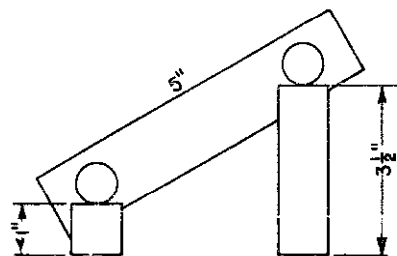

k

## G—Miscellaneous Measuring Instruments and Techniques

### 1—VARIOUS METHODS OF INSPECTION

**a—Zygo** indications on aluminum casting. A non-destructive testing method. A highly fluorescent penetrant is applied to the casting. Excess penetrant is removed from the casting. The part is then rinsed and dried. Developing powder is dusted on, which draws the penetrant out of the flaws. Under black light fluorescent spots mark the patterns of cracks in the casting.

**b—Magnafluxing.** 1) Work is magnetized in a direction perpendicular to the suspected defect. 2) In the dry method, dry powder is dusted over the magnetized steel part and the excess powder is removed. 3) Part is inspected for sharp lines of powder, marking surface defects. 4) Inspected piece is demagnetized.

**c—Definitions of surface roughness.** (Roughness, height and width, lay, waviness.)

**d—Cross-section of M.A. Profilometer** tracer unit. Tracer is moved over the surface, with its tracing point lightly touching. The vertical movement of the tracer point is converted into voltage fluctuations. The electronic equipment converts these readings into root mean square average heights in microinches.

**e—Pedestal comparator.** Pedestal supports table, lamphouse, and hood containing mirrors, lenses and the chart. The table is adjustable horizontally and vertically by the corresponding handwheel, and the object is brought into focus by a focusing nut. Use: Shadow of outline of test part is compared with an outline drawn on a chart; or the shadow of the object is lined up with a reference line, the table is moved by a micrometer, and when the next test point lines up with the same reference line, the micrometer is read, thus determining the desired dimension.

**f—Measurement with optical flat.** The bands shown result from a check of a flat surface. Using monochromatic yellow light and seeing 10 bands we have an air wedge thickness of  $10 \times 11.6$  or 116 micro-inches. (Wave length of the yellow light is 23.2 millionths of an inch, or half the wave length 11.6 microinches.)



a

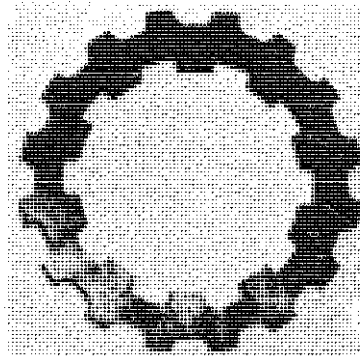

b

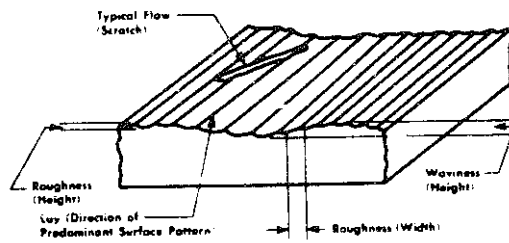

c

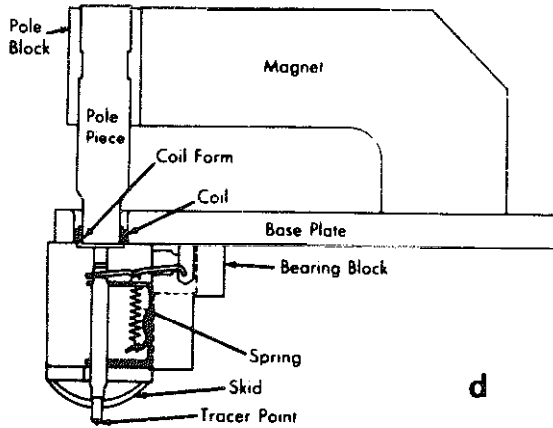

d

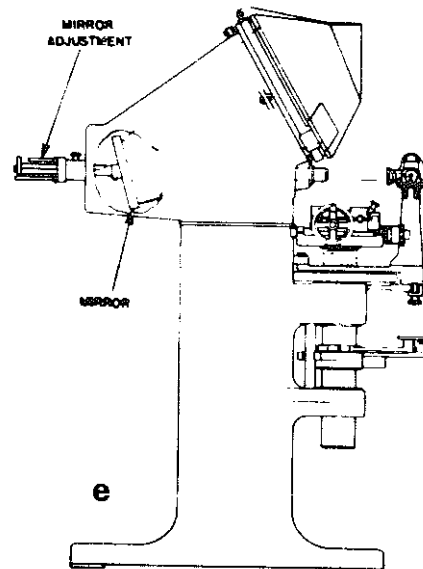

e

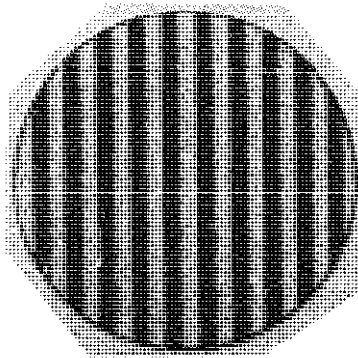

f

## G—Miscellaneous Measuring Instruments and Techniques

### 2-INSTRUMENTS AND SPECIAL GAGES

**a-Beam trammel** with some attachments. Used for layout work.

**b-Six- inch Pla-check gage.** The discs are spaced 1.0000 inches apart and the micrometer reads in 1/10000 of an inch.

**c-Elasticometer,** a spring tester. A, knife edge fulcrum; B, lever so balanced that pull on D is equal and opposite to E. Spring under test attached to D.G, adjustable counter weight; H, a 10: 1 lever with fulcrum at J; K, tray for weights. Counter weight balances empty tray.

**d-Checking pipe thread with three-roll taper thread gage.**

**e-Air- O -Limit gage,** schematic. This is a pressure type air gage. The gage is connected to the compressed air supply of the plant. The compressed air passes through the filter and the pressure regulator, which reduces it to about 40 psi. The reduced pressure is indicated on gage C. To remove fluctuations of air pressure, air is fed through the adjustable restriction D and then to the gaging spindle. Gage indicator E is calibrated with setting rings having limit markers indicating the high and low limits.

INSTRUMENTS & SPECIAL GAGES

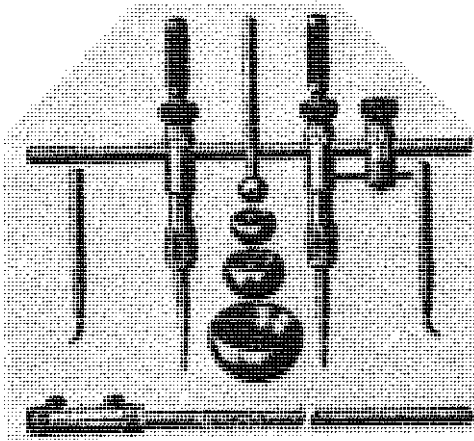

a

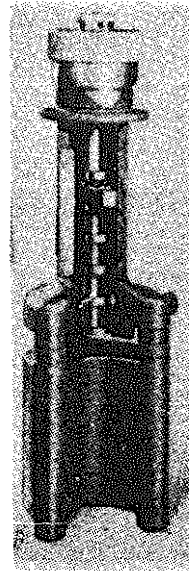

b

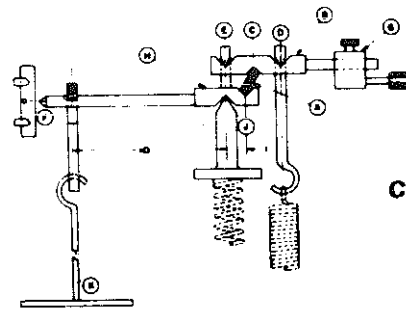

c

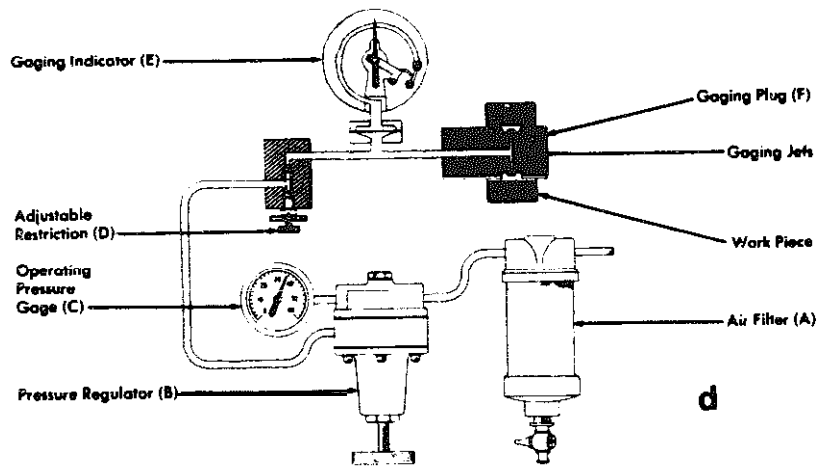

d

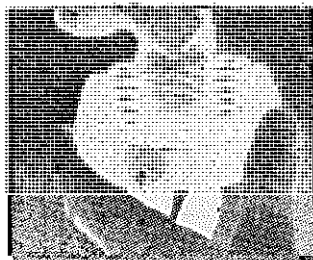

e



**H—Time**

**1—TIME AND TIME STUDY EQUIPMENT**

**a**—Stopwatch graduated in 1/100 of a second. (Lafayette Instrument Co.)

**b**—Stopwatch with stand. (Lafayette Instrument Co.)

**c**—Dual operation model stopwatch. Model Brenet No. 20K. All operations through the crown (start, stop, return.) For Time-out start by depressing crown, then move slide to stop. (Lafayette Instrument Co.)

**d**—Time study board. (Lafayette Instrument Co.)

**e**—Interval and repeat cycle timer, model 5040 B. An electronic timer. (Lafayette Instrument Co.)

**f**—Program time switch, model 25001. Precision, 24 hour Paragon timer. A 24 hour clock with skip-a-day feature.

**g**—Multi-pen event recorder, can record six different activities at the same time. Records up to 10 events per second. Different paper speeds act as time base. (Lafayette Instrument Co.)

TIME & TIME STUDY EQUIPMENT

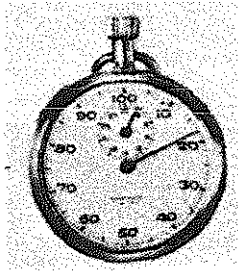

a

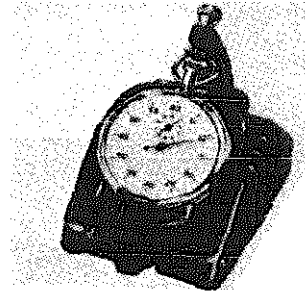

b

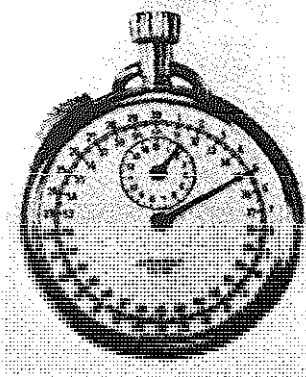

c

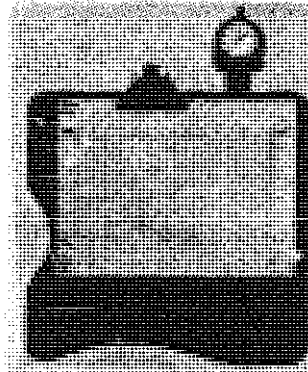

d

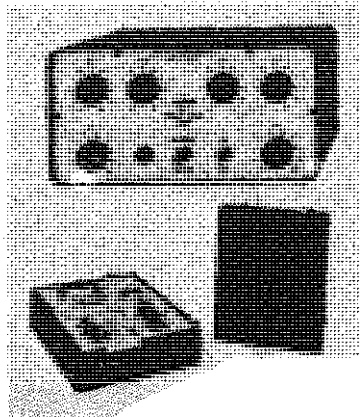

e

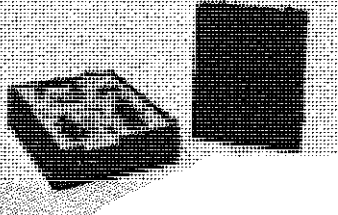

f

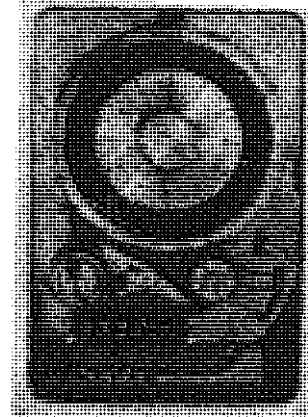

g

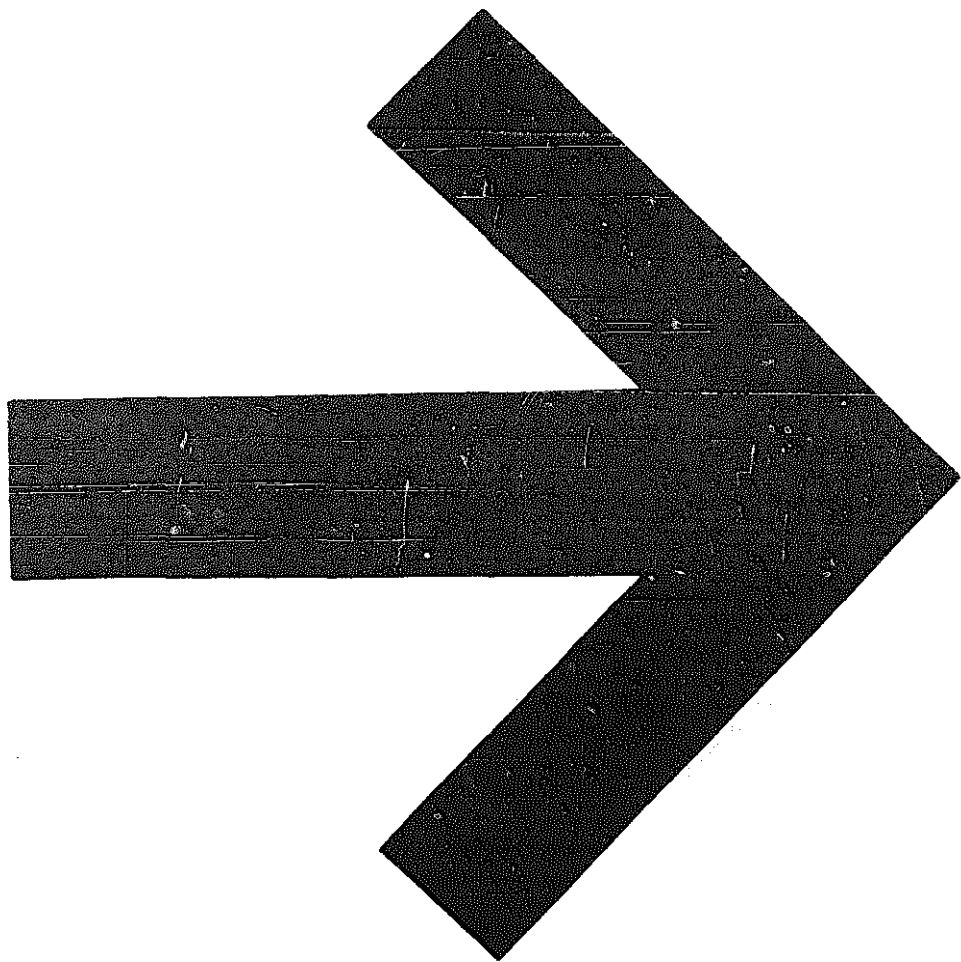

# INDEX

- Accelerometers, 566-567
- Accumulators, 360
- Adjusting devices, 160-167
- Adjustment, spiral torsion spring, 164-165
- Agitator, Brine, 430
- Air analysis, 510
  - blower, 444
  - conditioner, all year round, 504
    - add-on (for car), 506
    - central unit, 508
    - home, 504
    - oil-fired, 508
  - conditioning unit, large, 502
    - window, 504
      - Ford car, 506
      - system, all season, 506
- Air-o-limit gage, 596
- Alternator, single phase, 462
  - two-phase, 460
- Amplifiers, various types, 290
- Anchors, Danforth, 170-172
  - expansion, 172-173
  - fisherman's 170-172
  - marine & masonry, 170-171
  - mushroom, 170-172
  - trawl or sand, 170-172
- Angle, 466
  - bulb, 466
  - critical, 324
- Anvils, 434
- Apparatus, magnetic sizing, 428
- Apron, lathe, 410
- Arc suppression, 258
- Arches, hollow tile floor, 482
- Arithmetic, binary, 300
- Arm, pivoting steam or hydraulic, 110-111
- Astigmatism, 330
- Auger, 408
- Auto transformer, 462, 540-541
  
- Balances, 586
- Ball bearing, reciprocating, 28-29
- Band saw, 406
- Barometer, aneroid, 584
- Barrel, conical mixing, 430
- Base plates, column, 472
- Batteries, 236
- Beam, movable hook, 494
  - sling, 494
  - trammel, 596
- Bearing, double flanged, 34-35
  - flanged, 26-27, 29
  - half, 38-39
  - hanger, 36-37
  - hydro-static, 34-35
  - journals, 36-37
  - miscellaneous, 38-39
  - mounting methods, 32-33
  - multiple thrust collar, 34-35
  - needle, 30-31
  - pedestal, 36-37
  - pivot, 26-27, 38-39
  - plain, 34-35
- Bearings, babbited, 34-35
  - ring-oiled, 36-37
  - roller, 30-31
  - self aligning needle, 30-32
  - roller spherical, 30-32
  - tapered roller thrust, 30-31
  - tilting pad journal, 34-35
  - water lubricated, 34-35
- Bearing, ball, angular contact, 26-27, 29
  - deep groove, 26-27
  - duplex, 26-27
  - filling notch, 26-27
  - self-aligning, 26-27
  - spline, 28-29
  - split, 26-27
  - thrust, 28-29
- Belt arrangements, 92-93
  - Ewart's detachable link, 98-99
  - joints, 96-97
  - timing, 20-21, 90-91
  - V-, 90-91
- Biasing, (transistors), 292
- Binary, addition, 300
  - division, 300
  - multiplication, 300
  - subtraction, 300
- Binistor, 296
- Binoculars, prism, 350
- Blocking, 470
- Blocks and tackles, 108-109
- Blowtorch, 420
- Blowers, various, 364
- Bobbin winder, 130-131
- Bobbins, 432
- Body hammer and dolly, 396
- Bolt, and slot device, 134-135
  - foundation, 170-171
  - heads, special, 178-179
  - spring-wing toggle, 172-173
  - one piece toggle, 172-173
- Bolts, 182-185
- Bond, English brick, 482
  - Flemish brick, 482
- Boolean algebra, 306
- Booster, 358
- Borer, earth, 408
  - pin, 400
- Bourdon tubes, 542
- Brace, ratchet, 70-71
- Brake, air, locomotive, 110-111
  - double shoe, 10-11
  - hand, 10-11
- Brakes, 6-11
- Branching of steam pipes, 518
- Breaker mechanism, 446
- Brick, face, American bond, 482
- Bridge, cantilever, 478
  - linear inductance, 538-539
  - steel arched concrete, 478
  - swing, 478
- Bridges, 478
- Bucket, Hayward grab, 494
  - Williams grab, 494
  
- Caliper, hermaphrodite, 574-575
  - inside, 574-575
  - outside, 574-575
- Calipers, 162-163
- Cam, automotive, 148-149
  - constant breadth, 148-149
  - crown, 144-145
  - cylindrical, 144-145, 146-147
  - heart, 144-145
  - mechanisms, 144-151
  - multiple face, 148-149
  - three lobed, 144-145
- Cam follower, needle bearing, 30-32
- Camera, Cannon zoom 8, 340
  - elements, 336
  - movie, 338
    - Bolex 155, 340
    - single lens reflex, 338
- Capacitors, 244
- Capstan, 22-23, 156-157
- Carburetor, 446
- Cartridge, thermocouple, 548-549
- Catch and hook, 198-199
  - hinged, 198-199
- Catches, 198-199
- Ceiling grille, air flow, air mix of, 528
- Cell, voltaic, 262
- Center, piston, 112-113
  - punch, automatic, 392

- Chain, A.S.A. standard roller, 98-99
  - bead, 100-101
  - drives, 98-101
  - gear puller, 134-135
  - hoist, 494
  - Morse silent, 98-99
  - oil bath lubrication, 98-99
  - pintle, 100-101
- Chains, 104-107
- Chamber, combustion, 446
- Channel, standard, 466
- Chart, psychrometric, 510
- Chasers, 394
- Chemical effects of electricity, 238
- Chisel, 394
- Chopping, 424
- Chuck, hollow, 424
  - magnetic, 408
- Chucks, 212-213
- Circuit, fluorescent lamp, 318
  - hydraulic, 388
  - resonant, 246
- Circulator, Archimedean, 432
- Clamping device, 198-207
- Clamps, 202-203, 210-211, 214-215
- Clip, wire, 218-219
- Clock & watch mechanisms, 136-139
- Clutch, air actuated, 8-9
  - automotive, 6-7
  - centrifugal, 8-9
  - conical, 6-7
  - disc brake, 8-9
  - friction, 6-7
  - hydraulic operated, 10-11
  - jaw, 6-7
  - magnetic particle, 10-11
  - multiple disk, 8-9
  - one way, 6-7
  - overrunning, 8-9
  - pin, 6-7
  - spiral jaw, 6-7
  - spring friction, 6-7, 10-11
- Clutches, 6-11
- Coffer, louvered, 320
- Coil, radiant heating, 524
- Coils, 524
- Collar, expanding, 118-119
- Collector, cyclone, 428
- Collet, 410
- Column, doric, 482
  - ionic, 482
  - reinforced concrete, 482
  - roman, 482
  - strength increased through welding, 470
- Coma, 330
- Comparator, 594
  - optical, 344
- Compass, magnetic, 224
- Compressor, refrigerator, 500
  - rotary, 500
- Computer, digital, 302
  - input and output devices, 302
  - technology, 300
- Concrete, forms for, 482
- Condenser, (lens), 348
- Connecting rods, 46-47
- Connection, alternator, 462
  - fan discharge, 528
  - heater, filter, washer, cooler, 528
- Control, speed, 286
- Controller, liquid level, 518
- Coolers, air-to-oil, 358
- Cooling unit, brine spray, 504
  - surface type, 504
- Coping, 470
- Core, ferrite, 304
  - horseshoe, 460
- Cotters, 48-49
- Counter bore, 398
  - sink, 398
- Coupling, Ajax flexible, 14-15
  - American flexible, 14-15
  - angular shaft, 16-17
  - bent pin, 16-17
  - flanged shaft, 12-13
  - flexible, 14-15
  - flexible angular, 16-17
  - internal gear type, 14-15
  - hooks, 16-17
  - keyed sleeve, 12-13
  - metal bellows, 14-15
  - multi-jaw, 12-13
  - pin and slot, 16-17
  - quick disconnect, 382
  - roller & chain, 14-15
  - rubber hose, 14-15
  - seller's cone shaft, 12-13
  - rigid, sleeve, 12-13
  - steelflex, 14-15
- Crab, double purchase, 490
- Cradle dynamometer, 588
- Crane, cantilever gantry, 484
  - crawler, 484
  - gantry, 484
  - hammer head, 484
  - locomotive, 484
  - overhead travelling, 484
  - semigantry, 484
- Craneway, welded, 468
- Crank and toggle, 130-131
- Crooke's tube, 282
- Crushing, 426
- Crystal, rectifying effect, 248
- Cultivator, 422
- Current, alternating, 248
- Current, rectified, 290
- Curve, ovoid, 130-131
  - voltage, current and power, various, 462
- Cutter, disc, 424
  - formed milling, 412
  - head, revolving, 400
  - milling various, 404
  - reaping machine, 400
  - revolving, 400, 424
  - tubular, 400
  - washer, 398
- Cylinder, hydraulic, 128-129
  - telescoping, 354
- Cylinders, 354
  
- Derrick, A-frame, 486
  - breast, 486
  - fixed guy, 486
  - gin pole, 486
  - stiff-leg, 486
- Diac, 294
- Diaphragm, iris, 336
- Diaphragms, 50-51
- Die, blanking and drawing, 416
  - coining, 416
  - curling, 416
  - stock, 394
- Differential accumulator, 120-121
  - axle, 156-157
  - bevel gear, 120-121
  - gear hoist, weston, 158-159
  - piston indicator, 120-121
  - pulley block, 120-121
  - pulleys, 102-103
  - shaft derrick, 156-157
  - windlass, 156-157
- Diode, 276
  - tunnel, 296
  - varactor, 298
  - Zener, 296
- Dipping mechanism, 432
- Discs, 304
  - binary coded, 540-541
- Distorsion lenses, 334
- Dividing head, 412
  - table, 412
- Dolly, blacksmith's, 434
- Double slider crank chain, 142-143
- Downs cell, 238
- Drawing, die, 416
- Drill, diamond rock, 408
  - electric hand, 420
  - jig, 398
  - pneumatic, portable, 420
  - press, 398
  - rock, 110-111
- Drills, 398
- Dripping of steam mains, 518

## INDEX

- Drive, chain, 98-101
    - endless cord, 110-111
    - Ferguson indexing, 150-151
    - friction, 72-73
    - impulse, 126-127
    - roller disc, 126-127
    - vari-pitch, 126-127
  - Drum, hoisting, 102-103
    - magnetic, 304
  - Dynamometer, cradle, 588
  - Eccentric, triangular curved, 148-149
  - Egg beater, 430
  - Elasticometer, 596
  - Electric and magnetic field, 248
    - bell, 230
    - heating, 242
  - Electroforming, 438
  - Electrolysis of water, 238
  - Electromagnets, 230
  - Electronic devices, 276
  - Electrophorus, 234
  - Electroscope, 232
  - Elevator, bucket, 488
    - continuous bucket, 488
    - gravity discharge, 488
  - Encoder, photoelectric shaft-angle, 540-541
  - End mill, 404
  - Energy converting mechanisms, 156-159
  - Engine, continuous duct, 458
    - cross compound, 442
    - diesel, 444
    - intermittent duct, 458
    - internal combustion, 446
    - steam, 442
    - tandem compound, 442
    - thermal jet, 458
  - Equipment, oxy-acetylene welding, 420
  - Escapement, anchor, 136-137
    - dead-beat, 136-137
    - power, 146-147
    - rocking, 70-71
    - star-wheel, 136-137
    - stud, 136-137
  - Exacta camera, 338
  - Exchangers, heat, 358
  - Expander, spring, cup packing, 384
  - Expanding V-belt pulley, 124-125
  - Eye, human, 330
    - pieces, various, 346
  - Fan, blast, 434
    - brake, 588
  - Fastener, quarter turn, various, 218-219, 220-221
    - quick acting, 220-221
    - slide snap, 220-221
  - Fasteners & fastenings, 218-221
    - belt, 94-97
  - Feed, sawmill, 66-67
  - Files, 392
  - Filter action, 290
    - breather, 356
    - cartridge type, 362
    - hydraulic fluid, various, 362
  - Finishing, barrel, 426
  - Fitting, three piece flareless, 380
  - Fittings, 104-107
    - hose, 382
    - tube, 380
  - Fixture, drill grinding, 398
  - Flame of blowpipe, 420
  - Flare, tubing, 380
  - Fiat drill, 392
    - optical, 594
  - Fluid technology, 352
  - Foundry work, 436
  - Four cycle stokes, diesel, 444
    - link mechanism, conic or spherical, 168-169
  - Framing, beams to girders, 472
  - Fuel system, air injection, 444
    - mechanical injection, 444
  - Fuse, hydraulic, 376
  - Fusee barrel, 432
    - chain, 138-139
  - Gage, air operated, 582
    - Bourdon tube, 584
  - caliper snap, 576
  - dial indicator, 578
  - diaphragm, 584
  - electro-limit, 580
  - feeler, 578
  - fluid level, 356
  - limit, 576
  - micrometer depth, 578
    - plug, 578
  - planer, 580
  - plug, 576
    - thread, 576
  - radius, 576
  - ring, 576
  - small hole, 578
  - snap, 576
  - spline, 576
  - telescoping, 578
  - V-tube, 584
  - woodruff key, 578
- Galvanometers various, 260
  - Gas turbine, jet design, 456
    - Ljungstrom's, 456
  - Gaskets, 50-53
  - Gasometer, 118-119
  - Gate, diode transistor NOR, 312
  - Gear, bevel, 58-59
    - differential epicycloidal, 64-65
    - helical, 58-59
    - herringbone, 58-59
    - hypoid, 58-59
    - internal spur, 58-59
    - oval, 62-63
    - plain level, 62-63
    - pumps, 366
    - scroll bevel, 62-63
    - shifter, 132-133
    - spiral bevel, 58-59
      - hoop, 64-65
      - stop motion, 64-65
    - spur, 58-59
    - square, 60-61
    - sun and planet crank, 60-61
    - train, epicyclic, 60-61
      - four speed, 124-125
    - Zerol, 58-59
  - Generation, current, 460
    - power, 441
  - Generator, direct current, 462
  - Generator, electric, 460
  - Geneva stop, 138-139
  - Gin, cotton, 428
  - Girder, box, 468
  - Girders, 468
  - Globe, white class enclosing, 318
  - Gouges, 402
  - Governor, flyball, 442
    - turbine, 450
    - water wheel, 452
  - Grab bucket, 106-107
  - Grapple, 210-211
  - Gravity cell, 236
  - Grinder, lens, 426
  - Grinding, Belt, 438
    - centerless, 414
    - cylindrical, 414
    - electrolytic, 438
    - internal, 414
    - machine, 414
    - planetary internal, 414
  - Grinders, 414
  - Grip hook, 106-107
    - parallel vice, 210-211
    - tramway cable, 78-79
  - Grips, 214-215, 216-217
  - Guides, 18-19
  - Gyro system, 274
  - H-section, 466
  - Half-adder, 314
    - nut locking, 198-199
  - Hammer, ball-peen, 396
    - power, 434
  - Handle, tap wrench, 24-25
  - Handles, 22-25
  - Harmonic drive, 122-123
  - Harrows, 422

- Hasp and staple, 204-205  
 Haulage, rope supporting, 80-81  
 Head, boring-bar, 402  
 Headlamp, 344  
 Hearth, blacksmith's, 434  
 Heat pump, air-to-air, for cooling, 530  
   for heating, 530  
   systems, 530  
   water-to-water, for cooling, 530  
     for heating, 530  
 Heaters, electric, 242  
 Heating, radiant, 524  
   system, gravity warm air, 526  
   hot water, 520  
   vacuum, 512  
   vapor, 512  
   warm air, 526  
 Height gage, vernier, 572-573  
 Hertzian oscillator, 248  
 Hinge, universal, 112-113  
 Hinges, 40-41  
 Hitch, clove, 492  
   timber, 492  
 Hitches, 492  
 Hobbing of spur gear, 404  
 Hobs, 404  
 Hoist, air motor, 488  
   direct acting (pneumatic), 490  
   electric, 110-111, 490  
   hand, 102-103  
   monorail, 474  
   worm gear, 490  
 Hoisting drum and block, 102-103  
 Holder, tool, 402  
 Holders, 208-217  
 Hook, bale & clamp, 494  
   slip, 106-107  
 Hookes' universal joint, 112-113  
 Hook-eye, 106-107  
 Hooks, 104-107  
   double, 104-105  
   lifting, 494  
   various crane, 494  
 Hook-ups, steam various, 516  
 Hose construction, 382  
 Hoses, 382  
 Hot-water heating, radiant, 522  
   supply, down-feed, 520  
   upfeed, 520  
   system, forced circulation, 520  
     gravity, 520  
     reversed return, 520  
   temperature control, radiant heating, 522  
 Hot wire instrument, 264  
 Humidifier, spray type unit, 504  
   various, 504  
 Humidifying unit, 504, 508  
 Hydraulic jack, 158-159  
   press, 158-159  
 Hysteresis loop, 228  
  
 I-beam, 466  
 Ignition system, high tension, 446  
 Ignitron, 286  
 Illuminators, microscope, 348  
 Image formation, 328  
 Imagery, paraxial, 324  
 Images, 322  
 Impellers, pump, various, 370  
 Incablock shock absorber, 136-137  
 Inclined plane, 156-157  
 Indicator, air speed, 590  
   diagram, steam engine, 442  
 Industrial processes, 391  
 Infrared heating, 240  
 Installation of hoses, 382  
 Instruments, measuring, 260  
 Intensifier, reciprocating, 358  
  
 Jack, hydraulic, 490  
   rack & lever, 490  
 Jacobs drill chuck, 398  
 Jet propulsion, 456  
   ail rotary, 456  
   Campini design, 456  
  
 Joint, ball and socket, 16-17  
   belt, 94-97  
   butt, 194-195  
   cardan, 16-17  
   corner butt, 194-195  
   corner lap, 194-195  
   dado, 194-195  
   metal, 188-193  
   mortar various, 482  
   mortise & tenon, 194-195  
   rabbit & miter, 194-195  
   Rzeppa, 16-17  
   timber truss, 476  
   welded various, 480  
 Junker's four cylinder cycle events, 444  
  
 Key, gib, 198-199  
 Keys, 48-49  
 Knob, 24-25  
 Knot, figure 8, 492  
   simple overhand, 492  
  
 Ladles, foundry, 436  
 Lathe, 410  
   universal turret, 410  
 Lazy tongs, 116-117  
 Leclanché dry cell, 236  
 Lens, achromatic, 332  
   electrostatic, 284  
   magnetic electron, 284  
 Lenses, 322  
   camera, 336  
   contact, 330  
 Level, bench, 592  
 Lever and ratchet, 44-45  
   equalizing, 42-45, 146-147  
   first class, 42-43  
   second class, 42-43  
   third class, 42-43  
 Lifting pipe vertically, 494  
 Lifts for vacuum systems, 518  
 Light house, 344  
   polarized, 344  
 Link, adjustable, 46-47  
   split, 104-105  
 Links, 46-47  
 Live center for lathe, 410  
 Load cell, variable reluctance, 562-563  
 Lock bolt, 198-199  
   combination, 198-199  
 Lockwashers, nuts & screws, 176-187  
 Logic, computer, 306  
 Logical products, 308  
   sums, 308  
 Loud speaker, electrodynamic, 288  
   permanent magnet, 288  
 Lubrication, jet, 56-57  
   needle method, 54-55  
   oil cup, 54-55  
   mist, 56-57  
   pressure, 54-57  
   syphon method, 55-56  
   wick, 56-57  
 Lubricator, 56-57  
 Luminaires, 318  
  
 Machine, drafting, 152-153  
   engraving, 420  
   gravity, 452  
   horizontal table mixing, 430  
   jolt-squeeze molding, 436  
   spot welding, 420  
   wire-bending & cutting, 424  
 Machinery, agricultural, 422  
 Magnafluxing, 594  
 Magnet, lifting, 494  
 Magnetic domains, 224  
   field, 224, 228  
   induction, 224  
 Magnetism, 224  
 Magnetization curves, 228  
 Magnetostriction, 224  
 Magnifying glass, 348  
 Mandrel, expanding, 118-119  
 Mannesmann process, 118-119  
 Manometers, 584  
 Masonry, 482

## INDEX

- Match plate, 426
- Measuring tap for liquids, 582-583
  - volume, 582-583
- Mechanical switches, 252
- Mechanism, breaker, 446
  - grooved cam traverse, 130-131
  - transport, 130-131
- Mechanisms, 168-169
  - cam, 144-151
  - energy converting, 156-159
  - expanding and contracting, 116-119
  - kinematic, 140-143
- Memory, 304
- Meshes, 428
- Meter, revolving drum condensate, 582
  - taut band, 266
- Microfilm reader, 344
- Micrometer, outside, 572-573
  - inside, 572-573
  - screw thread, 572-573
- Microscope, electron, 284
  - stereoscopic, 348
- Microscopes, 348
- Mill, ball, 426
  - cone-roller, 426
  - conical, 426
  - end, 404
  - grinding, various, 426
  - kneading, 430
- Millers, 412
- Milling, chemical, 438
  - down, 412
  - machine, universal, 412
  - vertical, 412
  - straddle, 412
  - up, 412
- Mills, 426
- Mirror, concave and convex, 326
- Mirror, spherical, 326
- Mirrors, 326
- Mixer, candy, 430
  - concrete, 426-430
  - flash, for chemicals, 430
- Mixing barrel, 430
- Mold, 436
- Motion, circular, 128-131
  - elliptical crank end, 128-129
  - intermittent rotary, 68-69
  - lever and toggle, 158-159
  - parallel & straight line, 152-155
  - reciprocating, 128-131
  - transmissions, 110-113
  - variable devices, 124-127
- Mounting, cylinder, 354
- Multiple trammel gear, 128-129
- Multivibrator, 314
- Myopia, 330
  
- Nail, boat, 174-175
  - casing, 174-175
  - cut, 174-175
  - finishing, 174-175
  - tack, 174-175
- Nails, 174-175
- NAND, 308
- Nuts, 176-187
  
- O-ring, 354
- Oscillator, Hartley, 290
  
- Packing, hydraulic, 384
  - lip type, 384
  - U-cup, 354
  - V-type, 354
- Packings, 50-53
- Pantograph, 154-155
- Paracyl, 240
- Parallel bar expanding grilles, 116-117
  - blocks, magnetic, 408
  - motion, 152-153, 153-154
  - Cartwright's, 152-153
- Parallelogram, spherical, 168-169
- Pawl and star wheel, 70-71
  - gravity and ratchet wheel, 70-71
  - lift, 68-69
  - windlass grip, 68-69
  
- Pawls, 68-71
- Peaucellier straight line mechanism, 152-153
- Peck carrier, 488
- Pendulum, centrifugal, 136-137
  - compensating, 136-137
- Periscopes, 350
- Permanent magnets, 226
- Pick-up, electromagnetic, 590
  - proximity, 590
- Pile, concrete, 482
- Pillow block, 28-29
- Pinion, driving rack, 130-131
- Pinions, 66-67
- Pins, 48-49
- Pipe, 380
  - cutter, 400
  - section, threaded, 380
- Pitot tube, 590
- Pivoting arm and belt, 110-111
- Plane, Stanly block, 394
- Planer, 418
- Planes, 394
- Planetary automotive transmission, 122-123
  - gear train, 122-123
- Planimeter, 582
- Planocentric drive, 122-123
- Plate condenser, 232
  - surface, 392
- Plating, 238
- Pliers, long nose, 396
  - snap-ring, 396
- Plows, 422
- Plug, rawl, 172-173
- Plumb bob, 592
- Poles of magnet, 224
- Positive & negative electricity, 234
- Potentiometer, angular, 536-537
  - induction, 538-539
- Pour basin of mold, 436
- Power package, hydraulic, 356
- Press, double action, 416
  - inclinable power, 416
  - screw stamping, 158-159
- Presses, 416
- Pressure transducer, Capacitive, single stator type, 544
  - inductive absolute, 544-545
  - potentiometric, 545-547
- Prisms, 334
- Probe, cryogenic, 554-555
  - thermocouple, 548-549
- Profilometer, 594
- Projectors, 342
- Prony Brake, 588
- Protractor, bevel, 592
- Psychrometer, aspirating, 510
  - sling, 510
- Psychrometric chart, use of, 510
- Puller, gear, 396
- Pulley, flywheel, 84-85
  - belt, 92-93
  - block, worm gear, 102-103
  - coned, 20-21
  - crowned, 20-21
  - expanding, 20-21
  - fast and loose, 92-93
  - five step cone, 88-89
  - reversing, 132-133
  - wire rope, 78-79
- Pulleys, 20-21
- Pulverizer, centrifugal, 426
- Pump, axial piston, 368
  - centrifugal various types, 370
  - checkvalve radial piston, 368
  - external screw, 372
  - gerotor, 366
  - hele-shaw, 372
  - internal gear, 366
  - piston, 368
  - radial piston, 368
  - rotary, 364
  - screw, 364
  - swinging vane, 366
  - three lobed, 370
  - two lobed, 370
  - vane, 366
- Pumps, early types, 364



- Punch and die, 416
  - brass, 396
- Pyrometers, 554-555
- Rack, 66-7
  - circular, 66-67
  - worm screw, 66-67
- Radar display, 274
- Radiator connections, 514
- Radio communication and amplifiers, 288
- Ram, 354
- Rammers, 436
- Range finder, 350
- Ratchet Mechanism, 68-69
- Ratchets, 68-71
- Ray tracing, 334
- Reamer, shell, 408
- Reamers, 394
- Receiver, telephone, 268
- Rectifiers, silicon controlled, 294
- Reeves Beier Drive, 124-125
- Reflection, 322
- Reflectors, infrared heating, 240
  - various, 318
- Refraction, 322
- Refrigeration cycle, air cooled Servel, 500
  - direct system, 498
  - double indirect vented open-spray system, 498
  - home, 500
  - indirect closed surface system, 498
  - open spray system, 498
  - vented closed surface system, 498
- Refrigerator, 500
  - sealed unit, 500
- Relay, latching, 258
  - meter, 266
  - polarized, 258
- Relays and solenoids, 258
- Reservoirs, 356
- Resistance, 244
- Resolver, 274
- Rest, compound tool, 410
- Retaining rings
  - external, 218-219
  - internal, 218-219
- Rifflers, 392
- Right-hand thumb rule, 230
- Rings, slip, 462
- Riser, dripping down-feed, 514
- Riveter, hydraulic, 452
  - portable, 158-159
- Rivets & rivet heads, 192-193
- Rock drill, 110-111
- Rocket, liquid fuel, 458
  - reaction, dry fuel, 458
  - sky, 458
  - sounding, 458
- Rockets, 458
- Rolamite, 4-5
- Roller, corrugated, 432
- Rollers, 422
- Root's blower, 364
- Rope brake, 588
  - wire, 76-77
- Saw, back, 406
  - circular, 400
  - hack, 406
  - hydraulic, 406
  - scroll, 400
  - slitting, 404
  - teeth of, 406
- Scale, automatic tipping, 582-583
- Scavenging of engine, 444
- Screen, eccentric, 428
  - shaking or jiggling, 428
  - sloping, 428
- Screw drivers, 396
  - heads, 176-177
  - mooring, 170-171
- Screws, 176-187
- Scotch yoke, 128-129
- Seal, labyrinth, 50-51
  - O-ring, 384
- Seals, 50-53, 384
- Searchlight, 342
- Sector Press, 158-159
- Semiconductor, 292
- Separator, 470
- Servomechanisms, 270
- Servomotor, 272
- Set screws, 186-187
- Shackle, 78-79, 104-105
- Shaft, flexible, 16-17
  - telescoping, 16
- Shaper, 418
  - mechanism, 418
- Shapes, rolled, 466
- Shears, 394-400
  - compound lever, 400
  - three cutter tube, 400
- Sheave, 20-21, 78-79
- Shell-reamer, 408
- Shifter, leather belt, 132-133
- Shifting, gear & belt, 132-135
- Shock mounts & vibration isolators, 114-115
- Shutter, camera leaf type, 336
  - reflex mirror, 340
- Screening, 428
- Sifting, 428
- Sine bar, 592
- Sizing, air blast, 428
- Slicer and corer, apple, 424
- Slider crank chain, 140-141
- Slides, 18-19
- Slip rings, 462
- Slitting discs, 400
- Slot link and treadle, 130-131
- Smithing, 434
- Snap-flask, 436
- Socket, wire rope, 80-81
- Space mechanisms, 168-169
- Spectroscope, direct vision, 350
  - prism, 350
- Speedometer, centrifugal, 590
- Spherical aberration, 330
- Spindle, turret for drill press, 398
- Splice, 82-83
  - filler plates, 470
  - thimble, 492
- Splicing of columns, 470
- Splines, 48-49
- Split-ring commutator, 462
- Spool, 432
  - configuration of valves, 378
- Square, combination, 592
- Spring, air cushion, 4-5
  - Belleville, 2-3
  - conical, 2-3
  - finger washer, 2-3
  - flat, 4-5
  - spiral, 2-3
  - flexator, 4-5
  - helical compression, 2-3
    - tension, 2-3
  - leaf, 2-3
  - liquid, 4-5
  - motor, 4-5
  - neg'ator, 4-5
  - pawl, 162-163
  - rolamite, 4-5
  - sear, 4-5
  - slotted washer, 2-3
  - split ring, 4-5
  - torsion, 2-3
  - volute & double volute, 2-3
- Springs, 2-5
- Sprocket wheel & pitch chain, 98-99
- Spur gear differential, 120-121
- Static electricity, 232
- Steam engines, 442
  - run-out, risers dripped, 516
  - trap, thermostatic, 514
- Steam-heating hookups, 512
  - strainer, ahead of trap, 514
- Steel rules, 570-571
- Stone work, 482
- Stop, roller & latch stop, 70-71
- Storage elements, 304
- Strain gage, angular type, 540-541
  - pressure transducer, 546-547
  - various types, 558-559

- Straining, 428
- Stroboscopic disc, 590
- Structures, 466
- Struts, 468
- Support, I-beam track, 474
- Swage block, 434
- Swash plate, 148-149
- Switch, centrifugal, 254
  - crossbar, 256
  - inclination, 254
  - magnetic proximity, 252
- Switches,
  - mercury, 254
  - snap-action, 252
  - reed, 256
  - rotary magnetic reed, 256
  - stepping, 252
  - vacuum, 256
- Switching, core, 304
- Swivelling pipe joint, 112-113
- Symbols, hydraulic, 278
  - vacuum tube, 278, 280
- Synchro-transmitter, 272
- Synchros and resolvers, 272
  
- Table, compound slide, 408
- Tables, truth, 312
- Tachometer, toothed rotor, 564-565
- Tail stock, lathe, 410
- Take-offs, branch, 528
- Tank, closed expansion, 520
  - open expansion, 520
- Tap, 394, 398
- Tapping screws, 186-187
- Tee, structural, 466
- Telegraph key, 230
- Telephone, 268
- Telescope, Cassegrainian, 346
- Telescopes, 346
- Template, 408
- Tessar, Zeiss, 336
- Texrope varipitch speed changer, 86-87
- Thermagalvanometer, 262
- Thermistors, 550-551
- Thermocouples, 548-549
- Thermometer, surface, 552-553
- Thermometers, 588
- Thermostat, 588
  - bimetallic spiral type, 118-119
- Threads, 176-177
- Thyratron, 286
- Tie-rods, 472
- Tighteners, 92-93
- Timber joints, 196-197
  - scarf and butt, 196-197
- Time study equipment, 598
- Toggle joint, 44-45
  - stone breaker, 158-159
- Tongs, lifting, 494
- Tool, blacksmith's, 434
  - boring, 402
  - box, 208-209
  - broaching, 402
  - caulking, 394
  - cutting, planer & shaper, 402, 418
  - forming, 410
  - fullering, 394
  - hand, 392
  - hand planing, 402
  - holder, 208-209
  - knurling, 410
  - turning, 400
- Torch, oxy-acetylene, 408
- Torque converter, 126-127
- Track, bar, 474
  - Coburn type, 474
  - hopper & apron feeder, 488
  - I-beam, 474
- Trajectory, rocket, 458
- Transducer, displacement inductive, coupled, 534-535
  - linear variable resistance type, 536-537
  - magnetostrictive type, 562-563
  - moving dielectric, 534-535
  - non-contacting displacement type, 534-535
  - piezoelectric pressure, 544-545
  - piezoelectrive force, 562-563
  - potentiometric, 536-537
  - pressure dual stator capacitive, 544-545
  - rotor, 534-535
  - sensing elements, 542-543
  - variable reactance, 546-547
  - reluctive torque, 560-561
  - strain-gage force, 560-561
  - temperature, thermocouple, 548
  - velocity angular strain gage, 566-567
  - velocity, 564-565
- Transformer, 462
  - differential, 538-539
- Transformers, 250
- Transmission, belt, 88-91
  - textile rope, 82-87
  - wire-rope, 80-81
- Transmitter, telephone, 268
- Transistor, field effect, 296
  - mosfet, JFET, 298
  - various, 292
- Trap, float thermostatic, 516
- Triac, 294
- Trigistor, 296
- Troffers, 320
- Truss, fan, 476
  - floor, 476
  - king post, 476
  - riveted, 472
  - simple fink, 476
  - steep roof, 476
  - welded, 472
- Trusses, 476
  - various, 196-197
- Tube, beam power, 280
  - cathode and x-ray, 282
  - electrostatic, 284
  - gas filled, 286
  - magnetic, 284
  - nixie, 286
  - pentode, 280
  - television picture, 284
  - tetrode, 280
- Turbine, Camden, 450
  - gas, 454
  - Jonval, 450
  - Lancaster, 450
  - sections of, 448
  - steam, 448
  - Swain, 450
- Turbines, 448, 450
  
- Uniflow engine, 442
- Universal joint, 16-17
  - Bendix-Weiss constant-velocity, 16-17
  
- V-belt, 86-87
  - block, 392
  - 8 engine, 446
  - packings, 384
- Vacuum tubes, 276
- Valve, angle, check, 376
  - needle type, 374
  - plug type, 374
  - assembly, internal combustion engine, 446
  - ball, 374
  - Corliss engine, 442
  - deceleration, 376
  - flow control, 378
  - 4-way, manual lever, 374
  - gate, 374
  - globe, plug type, 374
  - in-line check, 376
  - needle type, 374
  - pilot operated, 378
  - pressure control, 378
    - controlled, 376
    - reducing, 378
  - relief, 378
  - rotary spool, 374
  - safety, 376
  - sequence, 378
  - shuttle, 376
  - single d-slide, 442
  - solenoid controlled dump & shut-off, 378
  - steam engines, 442
  - unloading, 378

- Vanes, guide for turbine, 450
- Venetian blind, 116-117
- Vent & drip on main, 514
- Vernier caliper, 572-573
- Vibration isolators & shockmounts, 114-115
- View finders, 336, 338
- Vise, pin, 392
  - table, 392
- Vises, 396
- Voltage curve, single phase, 460
  - three-phase alternator, 460
- Voltaic cell, 236
- Voltmeter, 260
  - digital, 266
- Washer, coal and ore, 432
  - rotary clothes, 432
- Watch & clock mechanisms, 136-139
- Water jet, force of, 450
  - meter, 582
  - wheel, undershot, 452
- Wattmeters, 264
- Waveforms, 288
  - theory, 248
- Wedge, 156-157
- Weighometer, 582-583
- Welded joints, 480
- Welding electric, 480
  - pipe, 380
  - shielded arc, 480
  - symbols, 190-191
- Welds, 190-191
  - examples of, 480
- Weston standard cell, 236
- Wheel design, hydraulic, 452
- Wheel
  - grinding, 414
  - lantern, 62-63
  - over shot, 452
  - Pelton, 452
  - pin, 70-71
  - ratchet crown, 68-69
- Whitworth quick return motion, 128-129
- Winch, standard differential, 120-121
- Winches, 102-103
- Wiper ring, 384
- Wire coil insert, 218-219
  - cutter discs, 400
  - gauze, square-mesh, 428
  - loop in magnetic field, 460
  - rope, 76-77
- Woodworking joints, 194-195
- Worm gear, 156-157
- Wrench, offset box, 396
  - torque, 396
- Wrenches, 396
- Zygo, 594